

SL18861DI Datasheet

www.digi-electronics.com

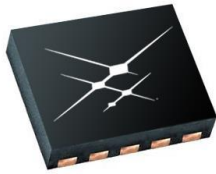

DiGi Electronics Part Number	SL18861DI-DG
Manufacturer	Skyworks Solutions Inc.
Manufacturer Product Number	SL18861DI
Description	IC CLK BUFFER 1:3 52MHZ 10TDFN
Detailed Description	Clock Fanout Buffer (Distribution) IC 1:3 52 MHz 10-WDFN

<https://www.DiGi-Electronics.com>



Tel: +00 852-30501935

RFQ Email: Info@DiGi-Electronics.com

DiGi is a global authorized distributor of electronic components.

Purchase and inquiry

Manufacturer Product Number:

SL18861DI

Series:

-

Type:

Fanout Buffer (Distribution)

Ratio - Input:Output:

1:3

Input:

LVC MOS

Frequency - Max:

52 MHz

Operating Temperature:

-40°C ~ 85°C

Package / Case:

10-WDFN

Base Product Number:

SL18861

Manufacturer:

Skyworks Solutions Inc.

Product Status:

Obsolete

Number of Circuits:

1

Differential - Input:Output:

No/No

Output:

LVC MOS

Voltage - Supply:

1.7V ~ 3.65V

Mounting Type:

Surface Mount

Supplier Device Package:

10-TDFN (2x1.4)

Environmental & Export classification

Moisture Sensitivity Level (MSL):

1 (Unlimited)

HTSUS:

8542.39.0001

ECCN:

EAR99



SL18861DI

3-Channel Clock Distribution Buffer

Key Features

- Low current consumption:
 - 2.7mA-typ (VDD=1.8V, CL=0)
- 1.70V to 3.65V power supply operation
- 10MHz to 52MHz CLKIN range
- Supports LVCMOS or Sine Inputs
- Supports 3 single-ended LVCMOS square wave or clipped sine wave outputs
- OE1/2/3 functions for each CLKOUT1/2/3 outputs
- OE_OSC control pin to enable external TCXO/XO
- Ultra-Low phase noise
- Ultra low standby current
- 10-pin TDFN package (1.4x2.0x0.75 mm)
- Industrial -40 °C to 85 °C temperature range

Application

- Smart Mobile Handsets
- Multi-mode RF Clock Distribution
- Baseband Peripheral Clock Distribution

Description

The SL18861DI product is a high performance 3 output clock distribution buffer and provides 3 outputs from a single input clock by using SLI proprietary low phase noise and low power dissipation circuit design.

The SL18861DI can be used in baseband mobile RF applications including WLAN, Bluetooth and DVB-H as an input clock reference. The product designed to isolate each device driven by their clock outputs to minimize interference between these devices.

Each of the clock buffer outputs can be individually disabled by using OE1/2/3 control pins to reduce the power consumption if the connected device does not need the clock. The device operates from single power supply from 1.70V to 3.65V and from -40 °C to 85 °C.

Benefits

- Fast Time-to-market
- Cost Reduction
- Low Power Dissipation
- Low Phase Noise

Block Diagram

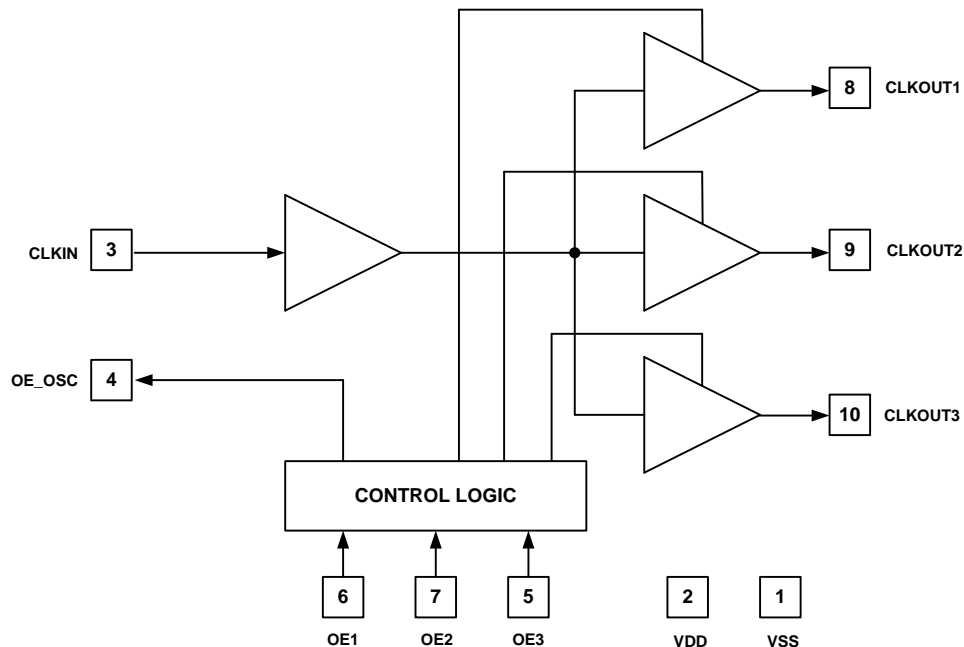



Pin Configuration

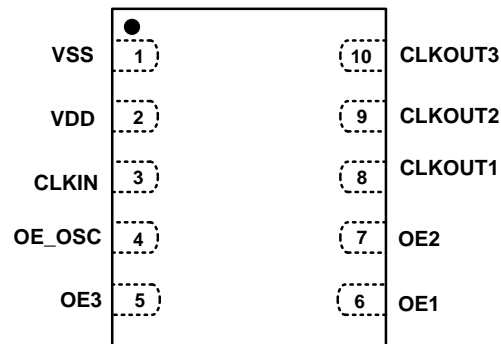

10-Pin TDFN Package Pinout

Pin Description

Pin Number	Pin Name	Pin Type	Pin Description
1	VSS	Power	Power supply ground.
2	VDD	Power	2.25 to 3.65V or 1.8V +/-5% positive power supply
3	CLKIN	Input	External clock input pin. VSS to VDD CMOS level.
4	OE_OSC	Output	Crystal oscillator enable pin. If OE1=OE2=OE3=0 then OE_OSC=0. OE_OSC=1 for all the other OE1/2/3 logic states.
5	OE3	Input	Output enable pin for CLKOUT3. The input has 150kΩ-typ on-chip pull-down resistor.
6	OE1	Input	Output enable pin for CLKOUT1. The input has 150kΩ-typ on-chip pull-down resistor.
7	OE2	Input	Output enable pin for CLKOUT2. The input has 150kΩ-typ on-chip pull-down resistor.
8	CLKOUT1	Output	Clock output-1. Clock frequency is the same as CLKIN.
9	CLKOUT2	Output	Clock output-2. Clock frequency is the same as CLKIN.
10	CLKOUT3	Output	Clock output-3. Clock frequency is the same as CLKIN.

OE1 (Input)	OE2 (Input)	OE3 (Input)	OE_OSC (Output)	CLKOUT1	CLKOUT2	CLKOUT3
0	0	0	0	Hi-Z	Hi-Z	Hi-Z
1	0	0	1	CLOCK	Hi-Z	Hi-Z
1	1	0	1	CLOCK	CLOCK	Hi-Z
...
1	1	1	1	CLOCK	CLOCK	CLOCK

Table 1. Truth Table for OE1/2/3, OE_OSC and CLKOUT1/2/3



Absolute Maximum Ratings

Description	Condition	Min	Max	Unit
Supply voltage, VDD (Absolute)		-0.5	4.6	V
Supply voltage, VDD (Operation)		1.65	3.63	V
All Inputs and Outputs		-0.5	VDD+0.5	V
Ambient Operating Temperature	In operation, C-Grade	-40	85	°C
Storage Temperature	No power is applied	-65	150	°C
Junction Temperature	In operation, power is applied	-	125	°C
Soldering Temperature		-	260	°C
ESD Rating (Human Body Model)	JEDEC22-A114D	-4,000	4,000	V
ESD Rating (Charge Device Model)	JEDEC22-C101C	-1,500	1,500	V
ESD Rating (Machine Model)	JEDEC22-A115D	-200	200	V

DC Electrical Characteristics (I-Grade)

Unless otherwise stated VDD= 1.8V+/- 5% and Operation Temperature Range -40 to +85°C

Description	Symbol	Condition	Min	Typ	Max	Unit
Operating Voltage	VDD	Operation range, 1.8V+/-5%	1.70	-	1.90	V
Operating Temperature	TA	I-Grade	-40	25	85	°C
Input Low Voltage	VIL	CMOS Level, Pins 3,5, 6 and 7	VSS	-	0.3VDD	V
Input High Voltage	VIH	CMOS Level, Pins 3,5, 6 and 7	0.7VDD	-	VDD	V
Output High Voltage	VOH	IOH=-4mA , Pins 4, 8, 9 and 10	VDD-0.4	-	-	V
Output Low Voltage	VOL	IOL=-4mA, Pins 4, 8, 9 and 10	-	-	0.4	V
Input Leakage Current	ILH	VIN=VDD, Pins 5, 6 and 7	-25	-	25	μA
Input Leakage Current	ILL	VIN=GND, Pins 5, 6 and 7	-10	-	10	μA
Pull-Down Resistor	RPD	Pins 5, 6 and 7	100	150	250	kΩ
Operating Supply Current	IDD1	CLKIN=26MHz, OE1=OE2=OE3=1, CL=0	-	2.7	-	mA
Operating Supply Current	IDD2	OE1=OE2=OE3=0 CLKIN=Low or High	-	-	1.0	μA
Input Capacitance	CIN	Pins 5, 6 and 7	-	3	5	pF
Load Capacitance	CL	CLKOUT1/2/3, Pins 8, 9 and 10	-	10	20	pF



AC Electrical Characteristics (I-Grade)

Unless otherwise stated VDD= 1.8V+/- 5% and Operation Temperature Range -40 to +85°C

Parameter	Symbol	Condition	Min	Typ	Max	Unit
Input Clock Range	CLKIN	External Clock, CMOS square wave or sine wave	10	26.000	52	MHz
Output Clock Range	CLKOUT	External Clock, CMOS square wave CLKOUT1/2/3	10	26.000	52	MHz
Input Clock Voltage Swing Level	VINpp	VDD=1.8V	0.72	1	-	Vpp
Input Duty Cycle	DCIN	CLKIN, Pin 3	30	50	70	%
Output Clock Rise Time	tr	VDD=1.8, CL=10pF, measured from 10 to 90% of VDD, Pins 4, 8, 9 and 10	-	2.0	4.00	ns
Output Clock Fall Time	tf	VDD=1.8, CL=10pF, measured from 10 to 90% of VDD, Pins 4, 8, 9 and 10	-	2.0	4.00	ns
Additive Phase Noise	APN-1	CLKIN=26MHz and 1 kHz offset CLKOUT1/2/3	-	-140	-	dBc/Hz
Additive Phase Noise	APN-2	CLKIN=26MHz and 10 kHz offset CLKOUT1/2/3	-	-150	-	dBc/Hz
Additive Phase Noise	APN-3	CLKIN=26MHz and 100 kHz offset CLKOUT1/2/3	-	-159	-	dBc/Hz
Power-up Time	tPU	Time duration until CLKOUT1/2/3 frequency reaches valid frequency after power supply reaches 0.9xVDD value	-	100	200	ns
Output Enable Time	tOE1	Time from OE raising edge to active at outputs CLKOUT1/2/3 (Asynchronous)	-	25	-	ns
Output Disable Time	tOD	Time from OE falling edge to Hi-Z at outputs CLKOUT1/2/3 (Asynchronous)	-	25	-	ns
Output Enable Time	tOE2	Active recovery time from standby (CLKIN=0 or 1) to active at outputs CLKOUT1/2/3	-	100	-	ns



DC Electrical Characteristics (I-Grade)

Unless otherwise stated VDD= 2.5V+/- 10% and Operation Temperature Range -40 to +85°C

Description	Symbol	Condition	Min	Typ	Max	Unit
Operating Voltage	VDD	Operation range, 2.5V+/10%	2.25	2.50	2.75	V
Operating Temperature	TA	I-Grade	-40	25	85	°C
Input Low Voltage	VIL	CMOS Level, Pins 3,5, 6 and 7	VSS	-	0.3VDD	V
Input High Voltage	VIH	CMOS Level, Pins 3,5, 6 and 7	0.7VDD	-	VDD	V
Output High Voltage	VOH	IOH=-4mA , Pins 4, 8, 9 and 10	VDD-0.4	-	-	V
Output Low Voltage	VOL	IOL=-4mA, Pins 4, 8, 9 and 10	-	-	0.4	V
Input Leakage Current	ILH	VIN=VDD, Pins 5, 6 and 7	-30	-	30	μA
Input Leakage Current	ILL	VIN=GND, Pins 5, 6 and 7	-15	-	15	μA
Pull-Down Resistor	RPD	Pins 5, 6 and 7	100	150	250	kΩ
Operating Supply Current	IDD1	CLKIN=26MHz, OE1=OE2=OE3=1, CL=0	-	3.0	-	mA
Operating Supply Current	IDD2	OE1=OE2=OE3=0 CLKIN=Low or High	-	-	1.5	μA
Input Capacitance	CIN	Pins 5, 6 and 7	-	3	5	pF
Load Capacitance	CL	CLKOUT1/2/3, Pins 8, 9 and 10	-	10	20	pF

AC Electrical Characteristics (I-Grade)

Unless otherwise stated VDD= 2.5V+/- 10% and Operation Temperature Range -40 to +85°C

Parameter	Symbol	Condition	Min	Typ	Max	Unit
Input Clock Range	CLKIN	External Clock, CMOS square wave or sine wave	10	26.000	52	MHz
Output Clock Range	CLKOUT	External Clock, CMOS square wave CLKOUT1/2/3	10	26.000	52	MHz
Input Clock Voltage Swing Level	VINpp	VDD=2.5V	1.0	1.2	-	Vpp
Input Duty Cycle	DCIN	CLKIN, Pin 3	30	50	70	%
Output Clock Rise Time	tr	VDD=1.8, CL=10pF, measured from 10 to 90% of VDD, Pins 4, 8, 9 and 10	-	2.0	4.00	ns
Output Clock Fall Time	tf	VDD=1.8, CL=10pF, measured from 10 to 90% of VDD, Pins 4, 8, 9 and 10	-	2.0	4.00	ns
Additive Phase Noise	APN-1	CLKIN=26MHz and 1 kHz offset CLKOUT1/2/3	-	-142	-	dBc/Hz



SL18861DI

Additive Phase Noise	APN-2	CLKIN=26MHz and 10 kHz offset CLKOUT1/2/3	-	-156	-	dBc/Hz
Additive Phase Noise	APN-3	CLKIN=26MHz and 100 kHz offset CLKOUT1/2/3	-	-164	-	dBc/Hz
Power-up Time	tPU	Time for CLKOUT1/2/3 frequency to reach valid frequency after power supply reaches 0.9xVDDvalue	-	100	200	ns
Output Enable Time	tOE1	Time from OE raising edge to active at outputs CLKOUT1/2/3 (Asynchronous)	-	25	-	ns
Output Disable Time	tOD	Time from OE falling edge to Hi-Z at outputs CLKOUT1/2/3 (Asynchronous)	-	25	-	ns
Output Enable Time	tOE2	Active recovery time from standby (CLKIN=0 or 1) to active at outputs CLKOUT1/2/3	-	100	-	ns

DC Electrical Characteristics (I-Grade)

Unless otherwise stated VDD= 3.3V+/- 10% and Operation Temperature Range -40 to +85°C

Description	Symbol	Condition	Min	Typ	Max	Unit
Operating Voltage	VDD	Operation range, 3.3V+/-10%	2.95	-3.3	3.65	V
Operating Temperature	TA	I-Grade	-40	25	85	°C
Input Low Voltage	VIL	CMOS Level, Pins 3.5, 6 and 7	VSS	-	0.3VDD	V
Input High Voltage	VIH	CMOS Level, Pins 3.5, 6 and 7	0.7VDD	-	VDD	V
Output High Voltage	VOH	IOH=-4mA, Pins 4, 8, 9 and 10	VDD-0.4	-	-	V
Output Low Voltage	VOL	IOL=-4mA, Pins 4, 8, 9 and 10	-	-	0.5	V
Input Leakage Current	ILH	VIN=VDD, Pins 5, 6 and 7	-35	-	35	µA
Input Leakage Current	ILL	VIN=GND, Pins 5, 6 and 7	-20	-	20	µA
Pull-Down Resistor	RPD	Pins 5, 6 and 7	100	150	250	kΩ
Operating Supply Current	IDD1	CLKIN=26MHz, OE1=OE2=OE3=1, CL=0	-	3.4	-	mA
Operating Supply Current	IDD2	OE1=OE2=OE3=0 CLKIN=Low or High	-	-	2.0	µA
Input Capacitance	CIN	Pins 5, 6 and 7	-	3	5	pF
Load Capacitance	CL	CLKOUT1/2/3, Pins 8, 9 and 10	-	10	25	pF



AC Electrical Characteristics (I-Grade)

Unless otherwise stated VDD= 3.3V+/- 10% and Operation Temperature Range -40 to +85°C

Parameter	Symbol	Condition	Min	Typ	Max	Unit
Input Clock Range	CLKIN	External Clock, CMOS square wave or sine wave	10	26.000	52	MHz
Output Clock Range	CLKOUT	External Clock, CMOS square wave CLKOUT1/2/3	10	26.000	52	MHz
Input Clock Voltage Swing Level	VINpp	VDD=3.3V	1.32	1.4	-	Vpp
Input Duty Cycle	DCIN	CLKIN, Pin 3	30	50	70	%
Output Clock Rise Time	tr	VDD=1.8, CL=10pF, measured from 10 to 90% of VDD, Pins 4, 8, 9 and 10	-	1.2	2.2	ns
Output Clock Fall Time	tf	VDD=1.8, CL=10pF, measured from 10 to 90% of VDD, Pins 4, 8, 9 and 10	-	1.2	2.2	ns
Additive Phase Noise	APN-1	CLKIN=26MHz and 1 kHz offset CLKOUT1/2/3	-	-138	-	dBc/Hz
Additive Phase Noise	APN-2	CLKIN=26MHz and 10 kHz offset CLKOUT1/2/3	-	-157	-	dBc/Hz
Additive Phase Noise	APN-3	CLKIN=26MHz and 100 kHz offset CLKOUT1/2/3	-	-165	-	dBc/Hz
Power-up Time	tPU	Time duration until CLKOUT1/2/3 frequency reaches valid frequency after power supply reaches 0.9xVDD value	-	100	200	ns
Output Enable Time	tOE1	Time from OE raising edge to active at outputs CLKOUT1/2/3 (Asynchronous)	-	25	-	ns
Output Disable Time	tOD	Time from OE falling edge to Hi-Z at outputs CLKOUT1/2/3 (Asynchronous)	-	25	-	ns
Output Enable Time	tOE2	Active recovery time from standby (CLKIN=0 or 1) to active at outputs CLKOUT1/2/3	-	100	-	ns



SL18861DI CLKOUT1/2/3							
Phase Noise (dBc/Hz) CL=15pF.							
VDD(V)	100hz	1Khz	10Khz	100Khz	1Mhz	5Mhz	Fig #
1.8	-115.52	-139.85	-150.79	-159.31	-160.52	-162.52	1
2.5	-125.16	-142.67	-156.37	-164.02	-166.45	-167.02	2
3.3	-116.60	-138.06	157.41	-164.88	-167.21	-168.57	3

Table 2. Output Phase Noise Summary Table

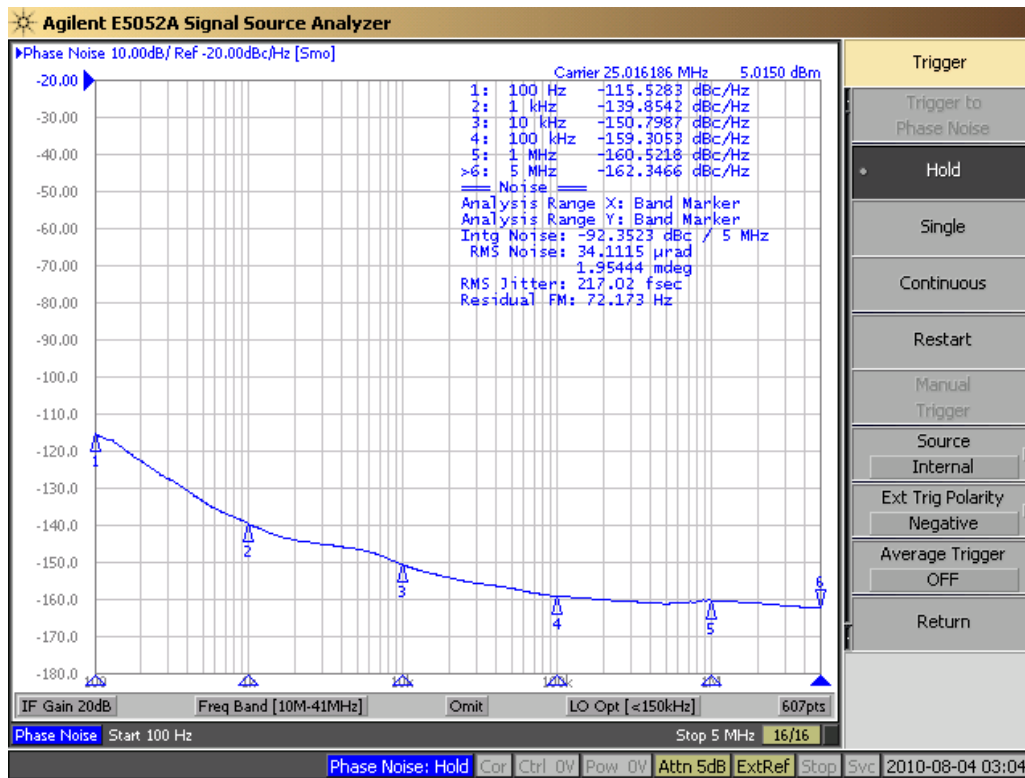

Figure 1. Output Phase Noise VDD=1.8V, CL=15pF

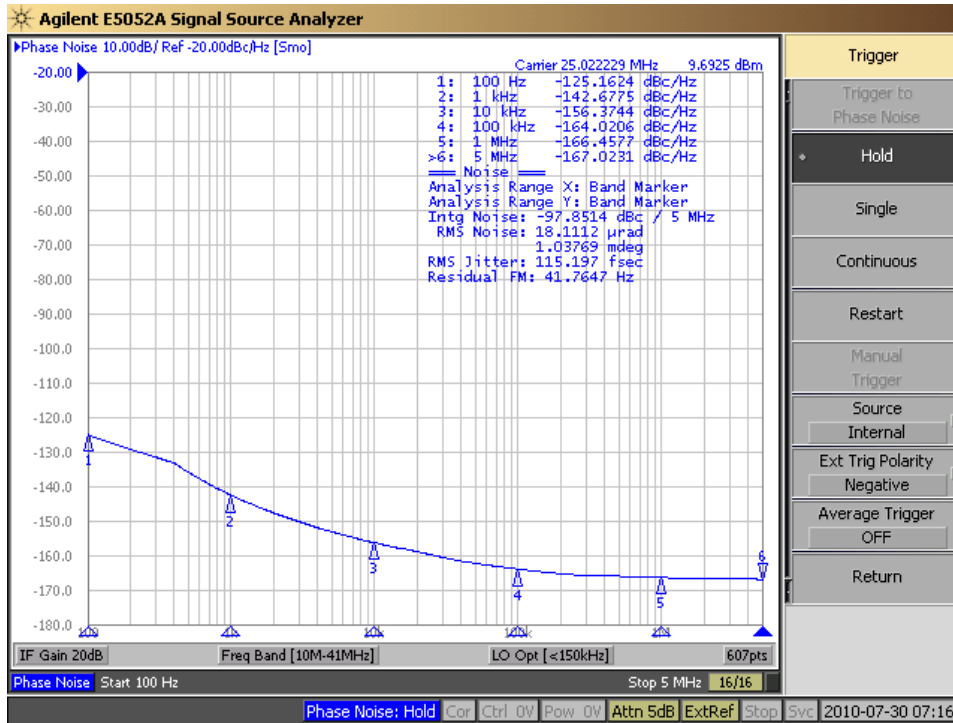

Figure 2. Output Phase Noise VDD=2.5V, CL=15pF

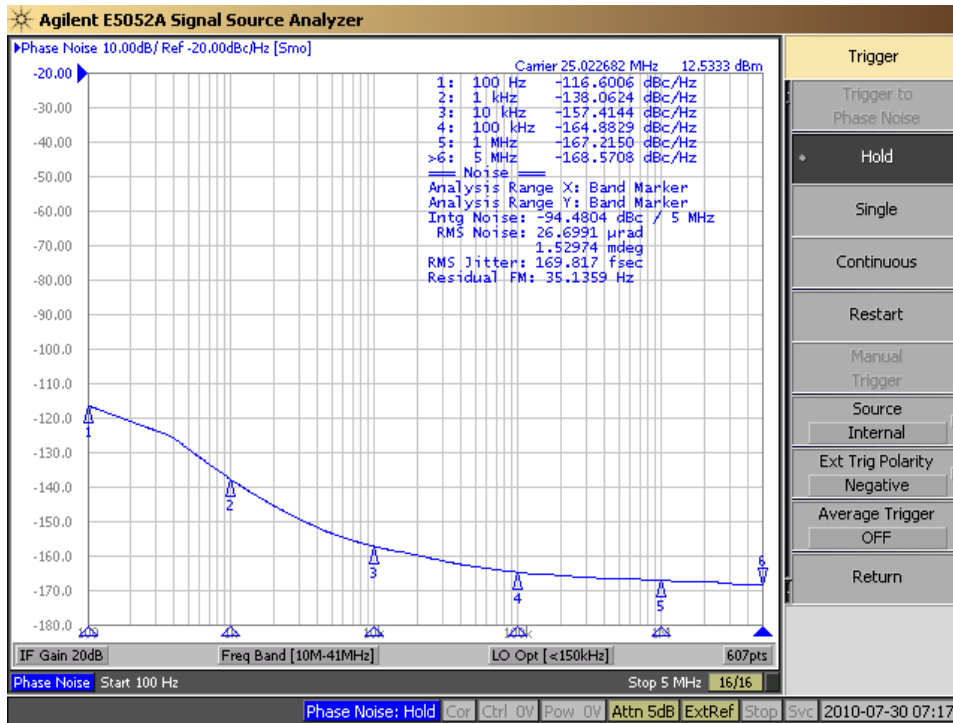
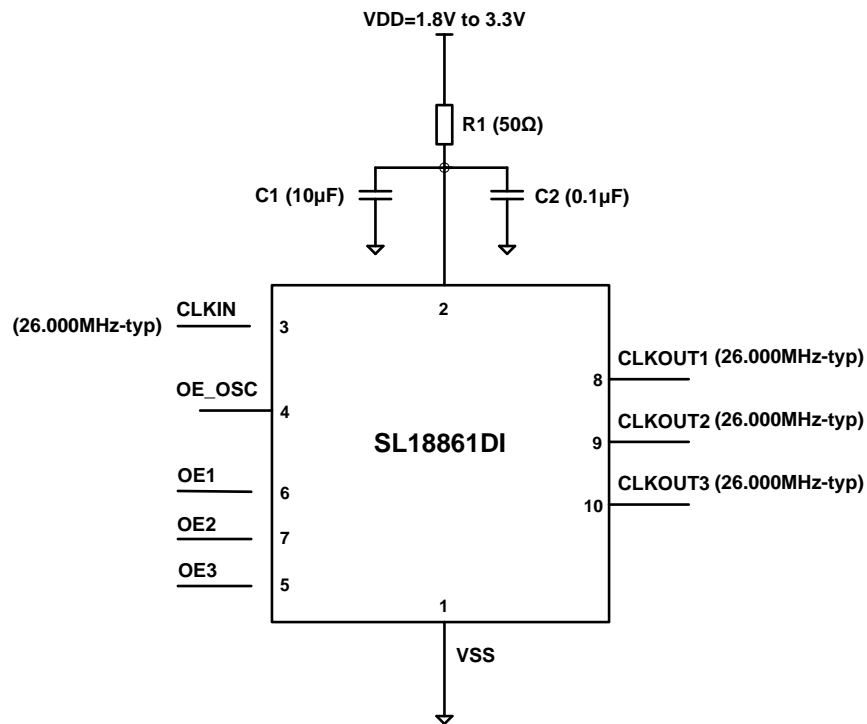

Figure 3. Output Phase Noise VDD=3.3V, CL=15pF



Typical Application Circuit





Package Outline and Package Dimensions

10-Pin TDFN Package (1.4x2.0x0.75 mm)

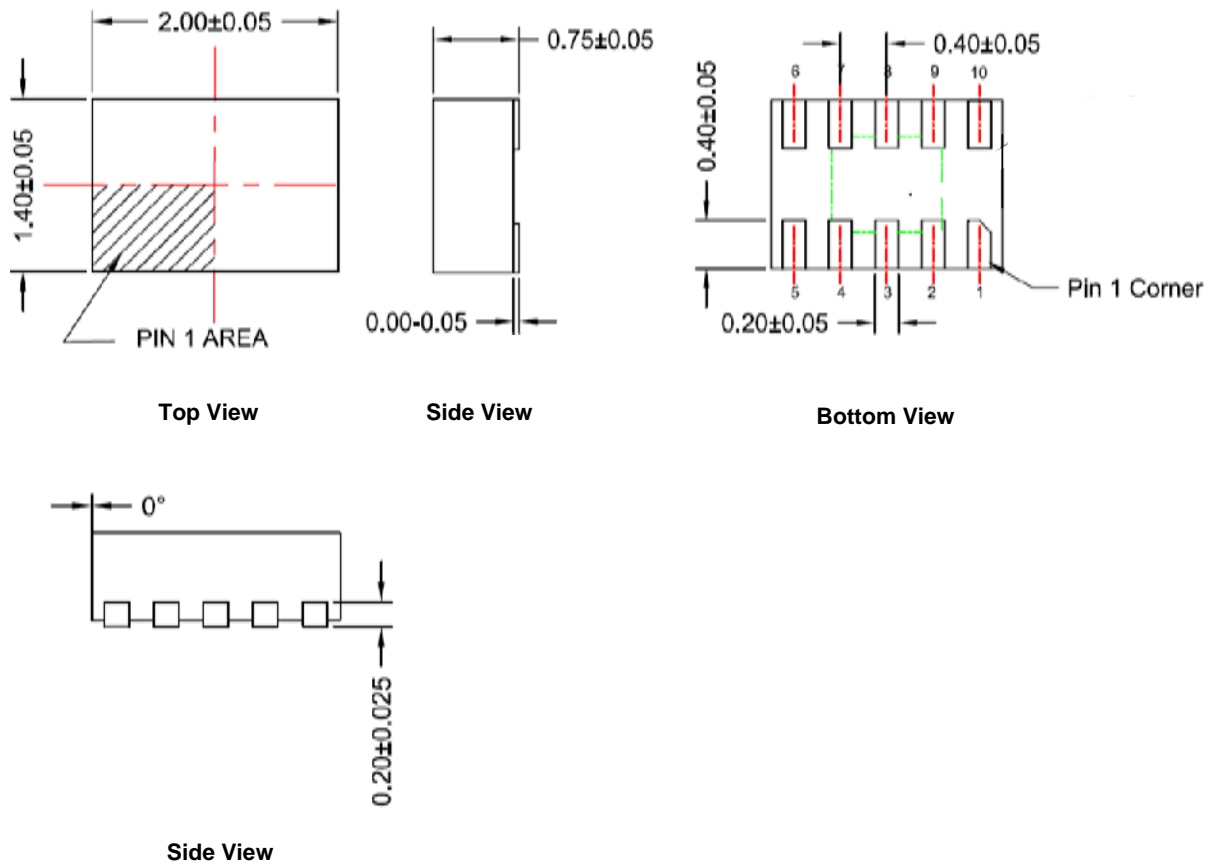



Ordering Information

Ordering Number	Marking	Shipping Package	Package	Temperature
SL18861DI	861	Tube	10-pin TDFN	-40 to 85°C
SL18861DIT	861	Tape and Reel	10-pin TDFN	-40 to 85°C

Note:

All SLI products are RoHS compliant

Marking Diagram:

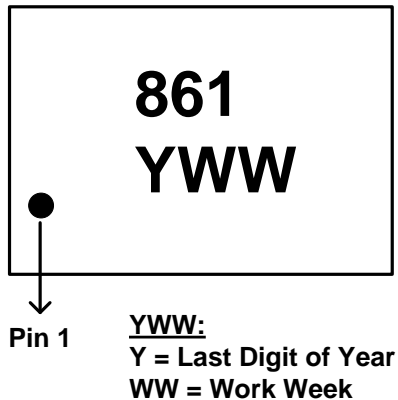

The information in this document is believed to be accurate in all respects at the time of publication but is subject to change without notice. Silicon Laboratories assumes no responsibility for errors and omissions, and disclaims responsibility for any consequences resulting from the use of information included herein. Additionally, Silicon Laboratories assumes no responsibility for the functioning of undescribed features or parameters. Silicon Laboratories reserves the right to make changes without further notice. Silicon Laboratories makes no warranty, representation or guarantee regarding the suitability of its products for any particular purpose, nor does Silicon Laboratories assume any liability arising out of the application or use of any product or circuit, and specifically disclaims any and all liability, including without limitation consequential or incidental damages. Silicon Laboratories products are not designed, intended, or authorized for use in applications intended to support or sustain life, or for any other application in which the failure of the Silicon Laboratories product could create a situation where personal injury or death may occur. Should Buyer purchase or use Silicon Laboratories products for any such unintended or unauthorized application, Buyer shall indemnify and hold Silicon Laboratories harmless against all claims and damages.

OUR CERTIFICATE

DiGi provide top-quality products and perfect service for customer worldwide through standardization, technological innovation and continuous improvement. DiGi through third-party certification, we stricly control the quality of products and services. Welcome your RFQ to

Email: Info@DiGi-Electronics.com



Tel: +00 852-30501935

RFQ Email: Info@DiGi-Electronics.com

DiGi is a global authorized distributor of electronic components.