

CSRN2512JTR430 Datasheet

www.digi-electronics.com

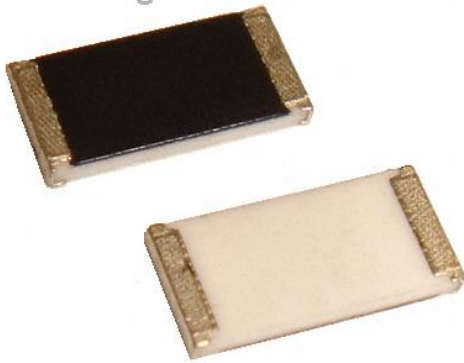

<https://www.DiGi-Electronics.com>

DiGi Electronics Part Number	CSRN2512JTR430-DG
Manufacturer	Stackpole Electronics Inc
Manufacturer Product Number	CSRN2512JTR430
Description	RES 0.43 OHM 5% 2W 2512
Detailed Description	430 mOhms ±5% 2W Chip Resistor 2512 (6432 Metric) Automotive AEC-Q200, Current Sense Thick Film

This model CSRN2512JTR430 is available at DiGi Electronics.

DiGi Electronics offers a global database of semiconductor and electronic component datasheets.

We welcome your inquiries regarding pricing, lead time, or other product-related questions.

 [Request a Quote](#)

 [Datasheet Search](#)



Tel: +00 852-30501935

RFQ Email: Info@DiGi-Electronics.com

DiGi is a global authorized distributor of electronic components.

Purchase and inquiry

Manufacturer Product Number:

CSRN2512JTR430

Series:

CSRN

Resistance:

430 mOhms

Power (Watts):

2W

Features:

Automotive AEC-Q200, Current Sense

Operating Temperature:

-55°C ~ 155°C

Supplier Device Package:

2512

Size / Dimension:

0.250" L x 0.124" W (6.35mm x 3.15mm)

Number of Terminations:

2

Manufacturer:

Stackpole Electronics Inc

Product Status:

Active

Tolerance:

±5%

Composition:

Thick Film

Temperature Coefficient:

±200ppm/°C

Package / Case:

2512 (6432 Metric)

Ratings:

AEC-Q200

Height - Seated (Max):

0.028" (0.70mm)

Failure Rate:

-

Environmental & Export classification

RoHS Status:

ROHS3 Compliant

REACH Status:

REACH Unaffected

HTSUS:

8533.21.0030

Moisture Sensitivity Level (MSL):

1 (Unlimited)

ECCN:

EAR99

CSR / CSRN Series
Thick Film Current Sensing Resistor

Stackpole Electronics, Inc.
Resistive Product Solutions



Features:

- 0201 to 1225 sizes available
- Power ratings to 3 W
- Available in E24 and other common values
- E96 and other values may be available upon request
- RoHS compliant, REACH compliant, lead free and halogen free

Electrical Specifications			
Type/Code	Power Rating (W) @ 70°C	TCR (ppm/°C)	Ohmic Range (Ω) and Tolerance
			1%, 2%, 5%
CSR0201	0.05	± 1000	0.1 - 0.13
		± 600	0.15 - 0.5
		± 300	0.51 - 1
CSR0402	0.125	± 200 ⁽¹⁾	0.05 - 1
CSR0603	0.125	± 300 ⁽³⁾	0.02 - 0.3
		± 200 ⁽²⁾	0.33 - 1
CSR0603-HP	0.2	± 400	0.051 - 0.1
		± 300	0.11 - 0.5
		± 200	0.51 - 1
CSR0805	0.25	± 200 ⁽³⁾	0.02 - 1
CSR0805-HP	0.5	± 400	0.051 - 0.1
		± 300	0.102 - 0.5
		± 200	0.51 - 1
CSR1206	0.5	± 100 ⁽²⁾	0.01 - 1
CSR1210	0.5	± 600	0.01 - 0.02
		± 400	0.022 - 0.051
		± 300	0.056 - 0.091
		± 200	0.1 - 1
CSR1210-HP	0.75	± 600	0.01 - 0.02
		± 400	0.022 - 0.05
		± 300	0.051 - 0.091
		± 200	0.1 - 1
CSR2010	1	± 200 ⁽³⁾	0.01 - 1
CSRN2010	1	± 200	0.01 - 1
CSR2512	2	± 200 ⁽³⁾	0.01 - 1
CSRN2512 ⁽¹⁾	2	± 200	0.01 - 1
CSR1225	3	± 300	0.003 - 0.004
		± 200	0.005 - 0.02
		± 150	0.022 - 0.03
		± 100	0.033 - 7.5

* AEC-Q200 Compliant

(1) Contact Stackpole for TCR below 500mΩ

(2) Contact Stackpole for TCR below 150mΩ

(3) Contact Stackpole for TCR below 100mΩ

Please refer to the High-Power Resistor Application Note for more information on designing and implementing high power resistor types.

Mechanical Specifications



Type/Code	Typical Unit Weight (mg)	L Body Length	W Body Width	T Body Height	D1 Top Termination	D2 Bottom Termination	Unit
CSR0201	0.18	0.024 ± 0.001 0.60 ± 0.03	0.012 ± 0.001 0.30 ± 0.03	0.009 ± 0.002 0.23 ± 0.05	0.005 ± 0.002 0.12 ± 0.05	0.006 ± 0.002 0.15 ± 0.05	inches mm
CSR0402	0.70	0.039 ± 0.002 1.00 ± 0.05	0.020 ± 0.002 0.50 ± 0.05	0.013 ± 0.004 0.32 ± 0.10	0.010 ± 0.004 0.25 ± 0.10	0.008 ± 0.004 0.20 ± 0.10	inches mm
CSR0603	2.0	0.063 ± 0.004 1.60 ± 0.10	0.031 ± 0.004 0.80 ± 0.10	0.018 ± 0.004 0.45 ± 0.10	0.012 ± 0.008 0.30 ± 0.20	0.012 ± 0.008 0.30 ± 0.20	inches mm
CSR0805 CSRN0805-HP	4.6 5.3	0.079 ± 0.006 2.00 ± 0.15	0.049 ± 0.006 1.25 ± 0.15	0.022 ± 0.004 0.55 ± 0.10	0.012 ± 0.008 0.30 ± 0.20	0.016 ± 0.010 0.40 ± 0.25	inches mm
CSR1206	8.7	0.120 ± 0.006 3.05 ± 0.15	0.061 ± 0.006 1.55 ± 0.15	0.022 ± 0.004 0.55 ± 0.10	0.020 ± 0.012 0.50 ± 0.30	0.016 ± 0.010 0.40 ± 0.25	inches mm
CSR1210	16.0	0.122 ± 0.004 3.10 ± 0.10	0.102 ± 0.006 2.60 ± 0.15	0.022 ± 0.004 0.55 ± 0.10	0.020 ± 0.012 0.50 ± 0.30	0.020 ± 0.010 0.50 ± 0.25	inches mm
CSR2010	27.0	0.197 ± 0.008 5.00 ± 0.20	0.096 ± 0.006 2.45 ± 0.15	0.024 ± 0.006 0.60 ± 0.15	0.024 ± 0.012 0.60 ± 0.30	0.067 ± 0.010 1.70 ± 0.25	inches mm
CSRN2010	23.7	0.197 ± 0.004 5.00 ± 0.10	0.098 ± 0.006 2.50 ± 0.15	0.024 ± 0.006 0.60 ± 0.15	0.024 ± 0.012 0.60 ± 0.30	0.020 ± 0.010 0.50 ± 0.25	inches mm
CSR2512	53.6	0.250 ± 0.004 6.35 ± 0.10	0.122 ± 0.006 3.10 ± 0.15	0.024 ± 0.004 0.60 ± 0.10	0.024 ± 0.012 0.60 ± 0.30	0.083 ± 0.004 2.10 ± 0.10	inches mm
CSRN2512	40.0	0.250 ± 0.004 6.35 ± 0.10	0.122 ± 0.006 3.10 ± 0.15	0.024 ± 0.004 0.60 ± 0.10	0.024 ± 0.012 0.60 ± 0.30	0.022 ± 0.010 0.55 ± 0.25	inches mm

Mechanical Specifications – Four Terminals



Type/Code	Typical Unit Weight (mg)	L	W	T	D1	D2	F	Unit
CSR1225	64.9	0.126 ± 0.006 3.20 ± 0.15	0.254 ± 0.006 6.45 ± 0.15	0.035 ± 0.006 0.90 ± 0.15	0.024 ± 0.012 0.60 ± 0.30	0.031 ± 0.010 0.80 ± 0.25	0.090 ± 0.005 2.29 ± 0.13	inches mm

Performance Characteristics				
Test	Test Method	Test Specification	Typical	Test Condition
Temperature Coefficient of Resistance (TCR)	JIS-C-5201-1 4.8 IEC-60115-1 4.8	As per specification	Pass	At 25°C/-55°C and 25°C/+125°C, 25°C is the reference temperature.
Short Time Overload	JIS-C-5201-1 4.13 IEC 60115-1 4.13	±(1% + 0.05Ω)	Pass	RCWV*2.5 or Max. Overload Voltage whichever is lower for 5 seconds
Insulation Resistance	JIS-C-5201-1 4.6 IEC-60115-1 4.6	≥ 10G	Pass	Max. Overload voltage for 1 minute
Endurance	JIS-C-5201-1 4.25 IEC-60115-1 4.25.1	0201~0603 ±(1% + 0.05Ω) 0805~2512 ±(2% + 0.05Ω)	Pass	70 ± 2°C, RCWV for 1000 hours with 1.5 hours "ON" and 0.5 hour "OFF"
Damp Heat with Load	JIS-C-5201-1 4.24 IEC-60115-1 4.24	0201~0603 ±(0.5% + 0.05Ω) 0805~2512 ±(1% + 0.05Ω)	Pass	40 ± 2°C, 90~95% R.H., RCWV for 1000 hours with 1.5 hours "ON" and 0.5 hour "OFF"
Dry Heat	JIS-C-5201-1 4.23 IEC-60115-1 4.23.2	0201~0603 ±(0.5% + 0.05Ω) 0805~2512 ±(2% + 0.05Ω)	Pass	at 155°C for 1000 hours
Bending Strength	JIS-C-5201-1 4.33 IEC-60115-1 4.33	±(1% + 0.05Ω)	Pass	Bending once for 60 seconds with 3 mm Sizes 2010 and 2512: 2 mm
Solderability	JIS-C-5201-1 4.17 IEC-60115-1 4.17	95% min. coverage	Pass	245 ± 5°C for 3 seconds
Resistance to Soldering Heat	JIS-C-5201-1 4.18 IEC-60115-1 4.18	±(0.5% + 0.05Ω)	Pass	260 ± 5°C for 10 seconds
Voltage Proof	JIS-C-5201-1 4.7 IEC-60115-1 4.7	No breakdown or flashover	Pass	1.42 times Max. Operating Voltage for 1 minute. 0201: 50 V; 0402: 100 V; 0603: 150 V; 0805: 300 V 1206/1210/2010/1225: 400 V 2512: 500 V
Leaching	JIS-C-5201-1 4.18 IEC-60068-2-58 8.2.1	Individual leaching area ≤ 5% Total leaching area ≤ 10%	Pass	260 ± 5°C for 30 seconds
Rapid Change of Temperature	JIS-C-5201-1 4.19 IEC-60115-1 4.19	±(0.5% + 0.05Ω)	Pass	-55°C (30 minutes)/+125°C (30 minutes, 5 cycles)

Operating temperature range is -55 to +155°C

RCWV (Rated Continuous Working Voltage) = √(P*R) or Max. Operating Voltage whichever is lower.

Recommended storage temperature is 15 to 28°C. Humidity < 80% R.H.

Power Derating Curve:

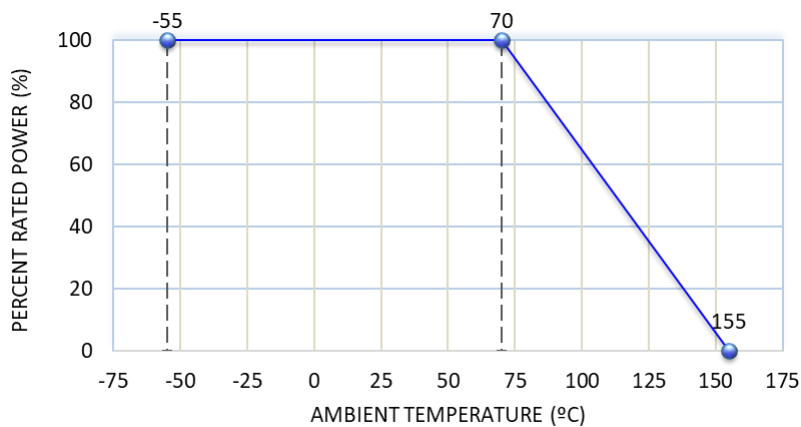

Recommended Pad Layouts

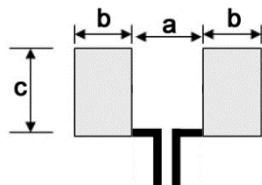

Type/Code	a	b	c	Unit
CSR0201	0.010	0.012	0.016 ± 0.008	inches
	0.25	0.30	0.40 ± 0.20	mm
CSR0402	0.020	0.020	0.024 ± 0.008	inches
	0.50	0.50	0.60 ± 0.20	mm
CSR0603	0.031	0.039	0.035 ± 0.008	inches
	0.80	1.00	0.90 ± 0.20	mm
CSR0805	0.039	0.039	0.053 ± 0.008	inches
	1.00	1.00	1.35 ± 0.20	mm
CSR1206	0.079	0.045	0.067 ± 0.008	inches
	2.00	1.15	1.70 ± 0.20	mm
CSR1210	0.079	0.045	0.098 ± 0.008	inches
	2.00	1.15	2.50 ± 0.20	mm
CSR2010	0.055	0.094	0.110 ± 0.008	inches
	1.40	2.40	2.80 ± 0.20	mm
CSRN2010	0.142	0.055	0.098 ± 0.008	inches
	3.60	1.40	2.50 ± 0.20	mm
CSR2512	0.039	0.140	0.126 ± 0.008	inches
	1.00	3.55	3.20 ± 0.20	mm
CSRN2512	0.193	0.063	0.126 ± 0.008	inches
	4.90	1.60	3.20 ± 0.20	mm
CSR1225	0.047	0.079	0.276 ± 0.008	inches
	1.20	2.00	7.00 ± 0.20	mm

Recommended Solder Profile

This information is intended as a reference for solder profiles for Stackpole resistive components. These profiles should be compatible with most soldering processes. These are only recommendations. Actual numbers will depend on board density, geometry, packages used, etc., especially those cells labeled with “*”.

100% Matte Tin / RoHS Compliant Terminations

Soldering iron recommended temperatures: 330 to 350°C with minimum duration.
Maximum number of reflow cycles: 3.

Wave Soldering

Description	Maximum	Recommended	Minimum
Preheat Time	80 seconds	70 seconds	60 seconds
Temperature Diff.	140°C	120°C	100°C
Solder Temp.	260°C	250°C	240°C
Dwell Time at Max.	10 seconds	5 seconds	*
Ramp DN (°C/sec)	N/A	N/A	N/A

Temperature Diff. = Difference between final preheat stage and soldering stage.

CSR / CSRN Series
Thick Film Current Sensing Resistor

Stackpole Electronics, Inc.
Resistive Product Solutions

Convection IR Reflow			
Description	Maximum	Recommended	Minimum
Ramp Up (°C/sec)	3°C/sec	2°C/sec	*
Dwell Time > 217°C	150 seconds	90 seconds	60 seconds
Solder Temp.	260°C	245°C	*
Dwell Time at Max.	30 seconds	15 seconds	10 seconds
Ramp DN (°C/sec)	6°C/sec	3°C/sec	*

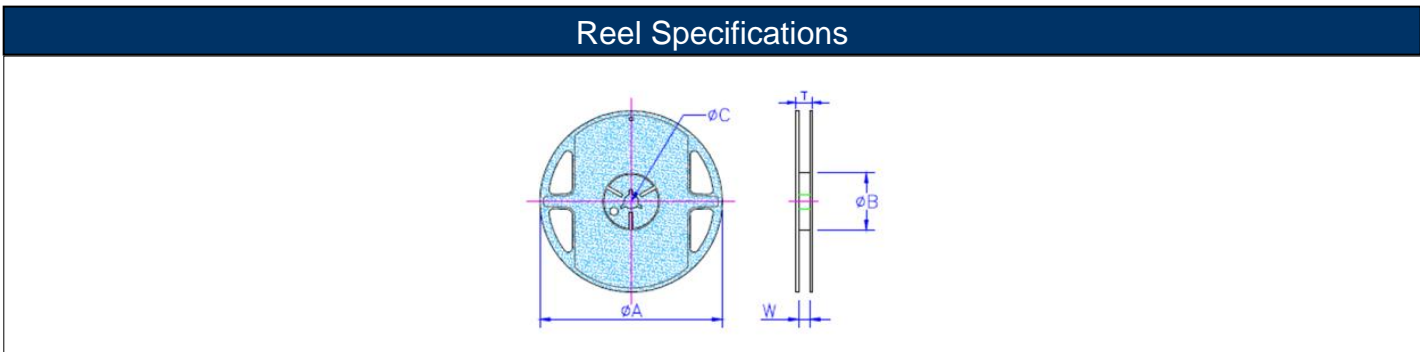
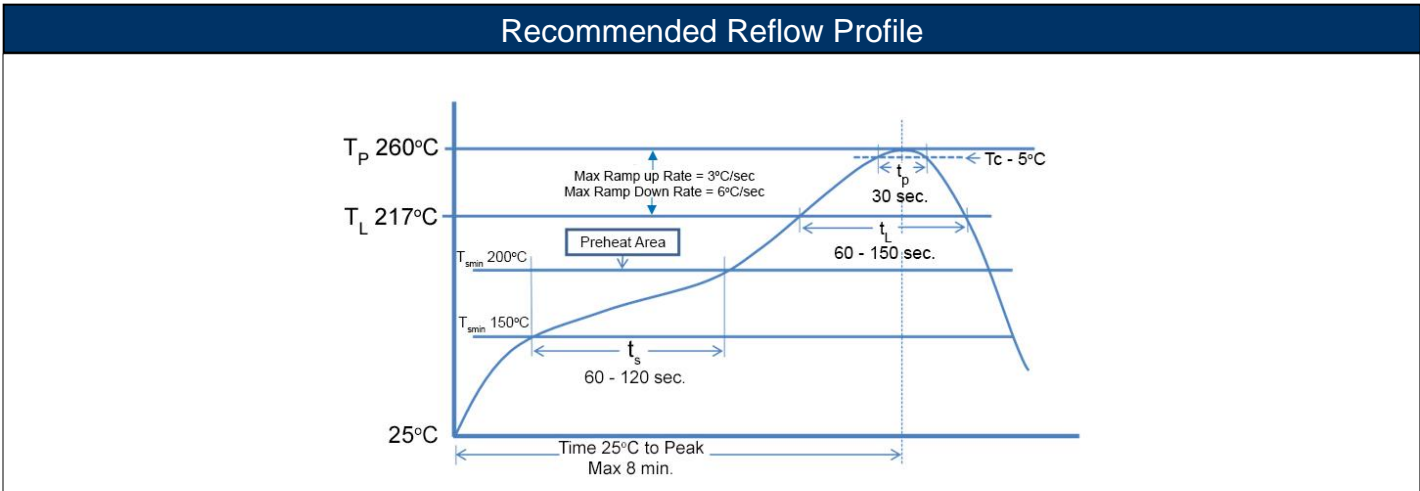

Type/Code	A	B	C	W	T	Unit
0201	7.008 ± 0.039	2.362 ± 0.039	0.531 ± 0.028	0.374 ± 0.004	0.453 ± 0.039	inches
	178.00 ± 1.00	60.00 ± 1.00	13.50 ± 0.70	9.50 ± 0.10	11.50 ± 1.00	mm
0402	7.008 ± 0.039	2.362 ± 0.039	0.531 ± 0.028	0.374 ± 0.004	0.453 ± 0.039	inches
	178.00 ± 1.00	60.00 ± 1.00	13.50 ± 0.70	9.50 ± 0.10	11.50 ± 1.00	mm
0603	7.008 ± 0.039	2.362 ± 0.039	0.531 ± 0.028	0.374 ± 0.004	0.453 ± 0.039	inches
	178.00 ± 1.00	60.00 ± 1.00	13.50 ± 0.70	9.50 ± 0.10	11.50 ± 1.00	mm
0805	7.008 ± 0.039	2.362 ± 0.039	0.531 ± 0.028	0.374 ± 0.004	0.453 ± 0.039	inches
	178.00 ± 1.00	60.00 ± 1.00	13.50 ± 0.70	9.50 ± 0.10	11.50 ± 1.00	mm
1206	7.008 ± 0.039	2.362 ± 0.039	0.531 ± 0.028	0.374 ± 0.004	0.453 ± 0.039	inches
	178.00 ± 1.00	60.00 ± 1.00	13.50 ± 0.70	9.50 ± 0.10	11.50 ± 1.00	mm
1210	7.008 ± 0.039	2.362 ± 0.039	0.531 ± 0.028	0.374 ± 0.004	0.453 ± 0.039	inches
	178.00 ± 1.00	60.00 ± 1.00	13.50 ± 0.70	9.50 ± 0.10	11.50 ± 1.00	mm
2010	7.008 ± 0.039	2.362 ± 0.039	0.531 ± 0.028	0.531 ± 0.039	0.610 ± 0.039	inches
	178.00 ± 1.00	60.00 ± 1.00	13.50 ± 0.70	13.50 ± 1.00	15.50 ± 1.00	mm
2512	7.008 ± 0.039	2.362 ± 0.039	0.531 ± 0.028	0.531 ± 0.039	0.610 ± 0.039	inches
	178.00 ± 1.00	60.00 ± 1.00	13.50 ± 0.70	13.50 ± 1.00	15.50 ± 1.00	mm
1225	7.008 ± 0.039	2.362 ± 0.039	0.531 ± 0.028	0.531 ± 0.039	0.610 ± 0.039	inches
	178.00 ± 1.00	60.00 ± 1.00	13.50 ± 0.70	13.50 ± 1.00	15.50 ± 1.00	mm

Packaging Specifications – Paper Tape

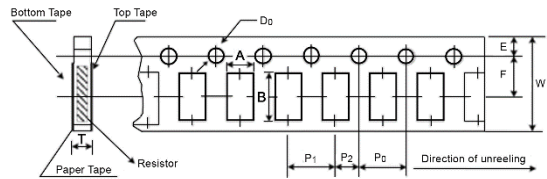

Size	A	B	W	E	F	Unit
0201	0.015 ± 0.002	0.027 ± 0.002	0.315 ± 0.004	0.069 ± 0.002	0.138 ± 0.002	inches
	0.38 ± 0.05	0.68 ± 0.05	8.00 ± 0.10	1.75 ± 0.05	3.50 ± 0.05	mm
0402	0.026 ± 0.004	0.045 ± 0.004	0.315 ± 0.008	0.069 ± 0.004	0.138 ± 0.002	inches
	0.65 ± 0.10	1.15 ± 0.10	8.00 ± 0.20	1.75 ± 0.10	3.50 ± 0.05	mm
0603	0.043 ± 0.004	0.075 ± 0.004	0.315 ± 0.008	0.069 ± 0.004	0.138 ± 0.002	inches
	1.10 ± 0.10	1.90 ± 0.10	8.00 ± 0.20	1.75 ± 0.10	3.50 ± 0.05	mm
0805	0.063 ± 0.004	0.094 ± 0.008	0.315 ± 0.008	0.069 ± 0.004	0.138 ± 0.002	inches
	1.60 ± 0.10	2.40 ± 0.20	8.00 ± 0.20	1.75 ± 0.10	3.50 ± 0.05	mm
1206	0.075 ± 0.004	0.138 ± 0.008	0.315 ± 0.008	0.069 ± 0.004	0.138 ± 0.002	inches
	1.90 ± 0.10	3.50 ± 0.20	8.00 ± 0.20	1.75 ± 0.10	3.50 ± 0.05	mm
1210	0.114 ± 0.004	0.138 ± 0.008	0.315 ± 0.008	0.069 ± 0.004	0.138 ± 0.002	inches
	2.90 ± 0.10	3.50 ± 0.20	8.00 ± 0.20	1.75 ± 0.10	3.50 ± 0.05	mm
Size	P0	P1	P2	D0	T	Unit
0201	0.157 ± 0.004	0.079 ± 0.002	0.079 ± 0.004	0.059 + 0.004/-0	0.017 ± 0.008	inches
	4.00 ± 0.10	2.00 ± 0.05	2.00 ± 0.10	1.50 + 0.10/-0	0.42 ± 0.20	mm
0402	0.157 ± 0.004	0.079 ± 0.002	0.079 ± 0.002	0.059 + 0.004/-0	0.018 ± 0.004	inches
	4.00 ± 0.10	2.00 ± 0.05	2.00 ± 0.05	1.50 + 0.10/-0	0.45 ± 0.10	mm
0603	0.157 ± 0.004	0.157 ± 0.002	0.079 ± 0.002	0.059 + 0.004/-0	0.028 ± 0.004	inches
	4.00 ± 0.10	4.00 ± 0.05	2.00 ± 0.05	1.50 + 0.10/-0	0.70 ± 0.10	mm
0805	0.157 ± 0.004	0.157 ± 0.002	0.079 ± 0.002	0.059 + 0.004/-0	0.033 ± 0.004	inches
	4.00 ± 0.10	4.00 ± 0.05	2.00 ± 0.05	1.50 + 0.10/-0	0.85 ± 0.10	mm
1206	0.157 ± 0.004	0.157 ± 0.002	0.079 ± 0.002	0.059 + 0.004/-0	0.033 ± 0.004	inches
	4.00 ± 0.10	4.00 ± 0.05	2.00 ± 0.05	1.50 + 0.10/-0	0.85 ± 0.10	mm
1210	0.157 ± 0.004	0.157 ± 0.002	0.079 ± 0.002	0.059 + 0.004/-0	0.033 ± 0.004	inches
	4.00 ± 0.10	4.00 ± 0.05	2.00 ± 0.05	1.50 + 0.10/-0	0.85 ± 0.10	mm

Packaging Specifications – Plastic Tape

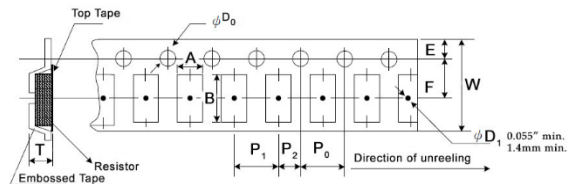

Size	A	B	W	E	F	Unit
2010	0.110 ± 0.004	0.217 ± 0.004	0.472 ± 0.012	0.069 ± 0.004	0.217 ± 0.002	inches
	2.80 ± 0.10	5.50 ± 0.10	12.00 ± 0.30	1.75 ± 0.10	5.50 ± 0.05	mm
2512	0.133 ± 0.004	0.263 ± 0.004	0.472 ± 0.012	0.069 ± 0.004	0.217 ± 0.004	inches
	3.38 ± 0.10	6.68 ± 0.10	12.00 ± 0.30	1.75 ± 0.10	5.50 ± 0.10	mm
1225	0.133 ± 0.004	0.263 ± 0.004	0.472 ± 0.012	0.069 ± 0.004	0.217 ± 0.004	inches
	3.38 ± 0.10	6.68 ± 0.10	12.00 ± 0.30	1.75 ± 0.10	5.50 ± 0.10	mm
Size	P0	P1	P2	D0	T	Unit
2010	0.157 ± 0.002	0.157 ± 0.004	0.079 ± 0.002	0.059 + 0.004/-0	0.039 ± 0.008	inches
	4.00 ± 0.05	4.00 ± 0.10	2.00 ± 0.05	1.50 + 0.10, -0	1.00 ± 0.20	mm
2512	0.157 ± 0.004	0.157 ± 0.004	0.079 ± 0.002	0.061 + 0.002/-0	0.057 ± 0.008	inches
	4.00 ± 0.10	4.00 ± 0.10	2.00 ± 0.05	1.55 + 0.05, -0	1.45 ± 0.20	mm
1225	0.157 ± 0.004	0.157 ± 0.004	0.079 ± 0.002	0.061 + 0.002/-0	0.057 ± 0.008	inches
	4.00 ± 0.10	4.00 ± 0.10	2.00 ± 0.05	1.55 + 0.05, -0	1.45 ± 0.20	mm

Marking Instructions

0201 and 0402 sizes are not marked.

0603 size has three-character marking with examples shown in the table below.

- 1% and 5% marking is the same
- E96 values are only available in 1% tolerance
- If the value has two significant digits, the marking is “R” plus the two significant digits (e.g. R10 = 100 mΩ)
- If the value has three significant digits, the marking is the three significant digits underlined (e.g. 047 = 47 mΩ)

0805 and larger sizes have four-character marking for both 1% and 5% tolerances.

Size	Ohmic Value					
	5 mΩ	20 mΩ	25 mΩ	100 mΩ	221 mΩ	250 mΩ
0201/0402	No marking					
0603 1%	NA	R02	<u>025</u>	R10	<u>221</u>	R25
0603 5%	NA	R02	<u>025</u>	R10	NA	R25
0805 and larger 1%	R005	R020	R025	R100	R221	R250
0805 and larger 5%	R005	R020	R025	R100	NA	R250

High Power Chip Resistors and Thermal Management

Stackpole has developed several surface mount resistor series in addition to our current sense resistors, which have had higher power ratings than standard resistor chips. This has caused some uncertainty and even confusion by users as to how to reliably use these resistors at the higher power ratings in their designs.

The data sheets for the RHC, RMCP, RNCP, CSR, CSRN, CSRF, CSS, and CSSH state that the rated power assumes an ambient temperature of no more than 100°C for the CSS / CSSH series and 70°C for all other high power resistor series. In addition, IPC and UL best practices dictate that the combined temperature on any resistor due to power dissipated and ambient air shall be no more than 105°C. At first glance this wouldn't seem too difficult, however the graph below shows typical heat rise for the CSR1206 100 milliohms at full rated power. The heat rise for the RMCP and RNCP would be similar. The RHC with its unique materials, design, and processes would have less heat rise and therefore would be easier to implement for any given customer.

CSR1206 100mΩ Surface Temperature Rise



The 102°C heat rise shown here would indicate there will be additional thermal reduction techniques needed to keep this part under 105°C total hot spot temperature if this part is to be used at 0.75 watts of power. However, this same part at the usual power rating for this size would have a heat rise of around 72°C. This additional heat rise may be dealt with using wider conductor traces, larger solder pads and land patterns under the solder mask, heavier copper in the conductors, via through PCB, air movement, and heat sinks, among many other techniques. Because of the variety of methods customers can use to lower the effective heat rise of the circuit, resistor manufacturers simply specify power ratings with the limitations on ambient air temperature and total hot spot temperatures and leave the details of how to best accomplish this to the design engineers. Design guidelines for products in various market segments can vary widely so it would be unnecessarily constraining for a resistor manufacturer to recommend the use of any of these methods over another.

Note: The final resistance value can be affected by the board layout and assembly process, especially the size of the mounting pads and the amount of solder used. This is especially notable for resistance values ≤ 50 mΩ. This should be taken into account when designing.

RoHS Compliance

Stackpole Electronics has joined the worldwide effort to reduce the amount of lead in electronic components and to meet the various regulatory requirements now prevalent, such as the European Union’s directive regarding “Restrictions on Hazardous Substances” (RoHS 3). As part of this ongoing program, we periodically update this document with the status regarding the availability of our compliant components. All our standard part numbers are compliant to EU Directive 2011/65/EU of the European Parliament as amended by Directive (EU) 2015/863/EU as regards the list of restricted substances.

RoHS Compliance Status						
Standard Product Series	Description	Package / Termination Type	Standard Series RoHS Compliant	Lead-Free Termination Composition	Lead-Free Mfg. Effective Date (Std Product Series)	Lead-Free Effective Date Code (YY/WW)
CSR	Thick Film Current Sensing Surface Mount Chip Resistor	SMD	YES	100% Matte Sn over Ni	May-04	04/18
CSRN	Thick Film Current Sensing Surface Mount Chip Resistor, Narrow	SMD	YES	100% Matte Sn over Ni	May-04	04/18

“Conflict Metals” Commitment

We at Stackpole Electronics, Inc. are joined with our industry in opposing the use of metals mined in the “conflict region” of the eastern Democratic Republic of the Congo (DRC) in our products. Recognizing that the supply chain for metals used in the electronics industry is very complex, we work closely with our own suppliers to verify to the extent possible that the materials and products we supply do not contain metals sourced from this conflict region. As such, we are in compliance with the requirements of Dodd-Frank Act regarding Conflict Minerals.

Compliance to “REACH”

We certify that all passive components supplied by Stackpole Electronics, Inc. are SVHC (Substances of Very High Concern) free and compliant with the requirements of EU Directive 1907/2006/EC, “The Registration, Evaluation, Authorization and Restriction of Chemicals”, otherwise referred to as REACH. Contact us for complete list of REACH Substance Candidate List.

Environmental Policy

It is the policy of Stackpole Electronics, Inc. (SEI) to protect the environment in all localities in which we operate. We continually strive to improve our effect on the environment. We observe all applicable laws and regulations regarding the protection of our environment and all requests related to the environment to which we have agreed. We are committed to the prevention of all forms of pollution.

CSR / CSRN Series
Thick Film Current Sensing Resistor

Stackpole Electronics, Inc.
Resistive Product Solutions

How to Order

C S R 1 2 0 6 F T 1 0 L 0 - H P

Product Series	
Code	Description
CSR	Standard
CSRN	Narrow Terminations

Size	
Code	W
0201	0.05
0402	0.125
0603	0.125
0603-HP	0.2
0805	0.25
0805-HP	0.5
1206	0.5
1210	0.5
1210-HP	0.75
2010	1
2512	2
1225	3

Tolerance	
Code	Tol
F	1%
G	2%
J	5%

Packaging			
Code	Description	Size	Quantity
T	7" Reel Paper Tape	0201, 0402	10000
		0603, 0805	5000
		1206, 1210	5000
	7" Reel Plastic Tape	2010, 2512	4000
1225		2000	
K	7" Reel Paper Tape	0402	1000
		0603, 0805	
	7" Reel Plastic Tape	2010, 2512 1225	

Resistance Value
Four characters with the multiplier used as the decimal holder. "L" used as multiplier of 10 ⁻³ for any value under 0.1 ohm
0.051 ohm = 51L0 0.35 ohm = R350 1 ohm = 1R00

Special	
Code	Description
blank	Standard
-HP	High Power

OUR CERTIFICATE

DiGi provide top-quality products and perfect service for customer worldwide through standardization, technological innovation and continuous improvement. DiGi through third-party certification, we stricly control the quality of products and services. Welcome your RFQ to

Email: Info@DiGi-Electronics.com



Tel: +00 852-30501935

RFQ Email: Info@DiGi-Electronics.com

DiGi is a global authorized distributor of electronic components.