

RACF164DJT82K0 Datasheet

www.digi-electronics.com

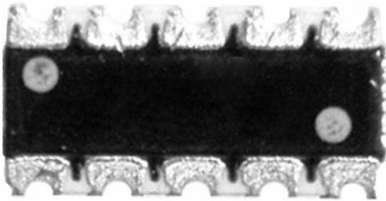

<https://www.DiGi-Electronics.com>

DiGi Electronics Part Number	RACF164DJT82K0-DG
Manufacturer	Stackpole Electronics Inc
Manufacturer Product Number	RACF164DJT82K0
Description	RES ARRAY 4 RES 82K OHM 1206
Detailed Description	82k Ohm $\pm 5\%$ 62.5mW Power Per Element Isolated 4 Resistor Network/Array ± 200 ppm/ $^{\circ}$ C 1206 (3216 Metric), Concave, Long Side Terminals

This model RACF164DJT82K0 is available at DiGi Electronics.

DiGi Electronics offers a global database of semiconductor and electronic component datasheets.

We welcome your inquiries regarding pricing, lead time, or other product-related questions.

 [Request a Quote](#)

 [Datasheet Search](#)



Tel: +00 852-30501935

RFQ Email: Info@DiGi-Electronics.com

DiGi is a global authorized distributor of electronic components.

Purchase and inquiry

Manufacturer Product Number:

RACF164DJT82K0

Series:

RACF

Circuit Type:

Isolated

Tolerance:

±5%

Resistor Matching Ratio:

-

Number of Pins:

8

Temperature Coefficient:

±200ppm/°C

Grade:

Automotive

Applications:

-

Package / Case:

1206 (3216 Metric), Concave, Long Side Terminals

Size / Dimension:

0.126" L x 0.063" W (3.20mm x 1.60mm)

Manufacturer:

Stackpole Electronics Inc

Product Status:

Obsolete

Resistance (Ohms):

82k

Number of Resistors:

4

Resistor-Ratio-Drift:

-

Power Per Element:

62.5mW

Operating Temperature:

-55°C ~ 155°C

Qualification:

AEC-Q200

Mounting Type:

Surface Mount

Supplier Device Package:

-

Height - Seated (Max):

0.030" (0.75mm)

Environmental & Export classification

RoHS Status:

ROHS3 Compliant

REACH Status:

REACH Unaffected

HTSUS:

8533.21.0020

Moisture Sensitivity Level (MSL):

1 (Unlimited)

ECCN:

EAR99

RACF Series (DISCONTINUED)

Concave Termination Chip Resistor Array

Stackpole Electronics, Inc.
Resistive Product Solutions

Features:

- Product will be discontinued - not recommended for new designs
- Last time buy December 1, 2020
- For more information please see our [PDN here](#)
- RAVF series of convex arrays is recommended as replacement
- RoHS compliant, REACH compliant, lead free, and halogen free
- AEC-Q200 compliant

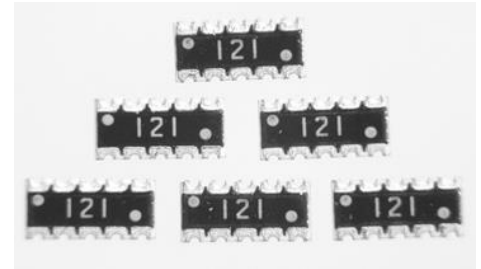

Electrical Specifications							
Type / Code / # of Elements / Circuit Type	Power Rating (W) (per element) @ 70°C	Maximum Working Voltage (V)	Maximum Overload Voltage (V)	TCR (ppm/°C)	Ohmic Range (Ω) and Tolerance		
					1%	2%	5%
RACF102D	0.063	25	50	± 650	3 - 9.88		
				± 250	10 - 1M		
RACF104D	0.063	25	50	± 400	1 - 9.88		
				± 200	10 - 1M		
RACF164D	0.063	50	100	± 200	22 - 1M	10 - 1M	
RACF324D	0.125	200	400	± 200	-	10 - 1M	
RACF408M	0.063	25	50	± 200	-	22 - 1M	
RACF648N	0.063	50	100	± 200	-	22 - 1M	
RACF648R	0.063	50	100	± 200	-	22 - 1M	

Note: (1) Lesser of $\sqrt{P \cdot R}$ or maximum working voltage.

Performance Characteristics	
Test	Test Results (JIS C 5202)
Load Life in Moisture	± 3%
Temperature cycle	± 1%
Load Life	± 3%
Resistance to Soldering heat	± 1%
Terminal Adhesion	± 1%
Short Time Overload	± 2%

Operating Temperature Range: RACF102D and RACF104D: -55°C to 155°C
All other types: -55°C to 125°C

Power Derating Curve:

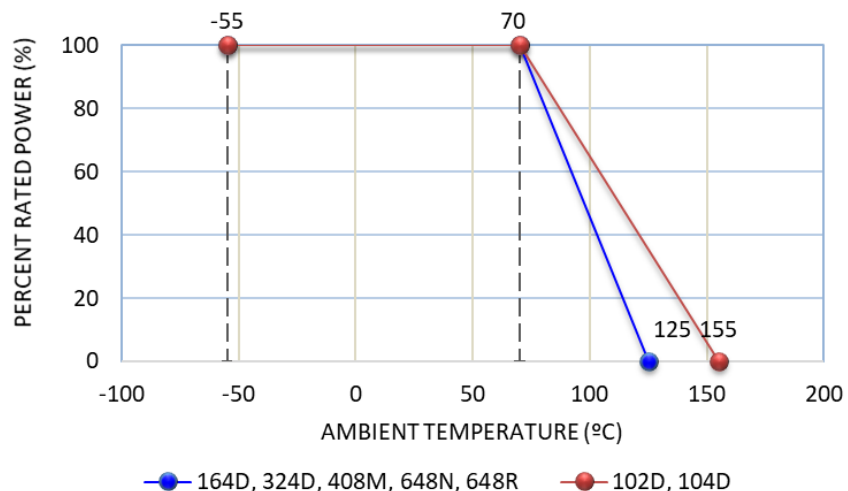

RACF Series (DISCONTINUED)

Concave Termination Chip Resistor Array

Stackpole Electronics, Inc.
Resistive Product Solutions

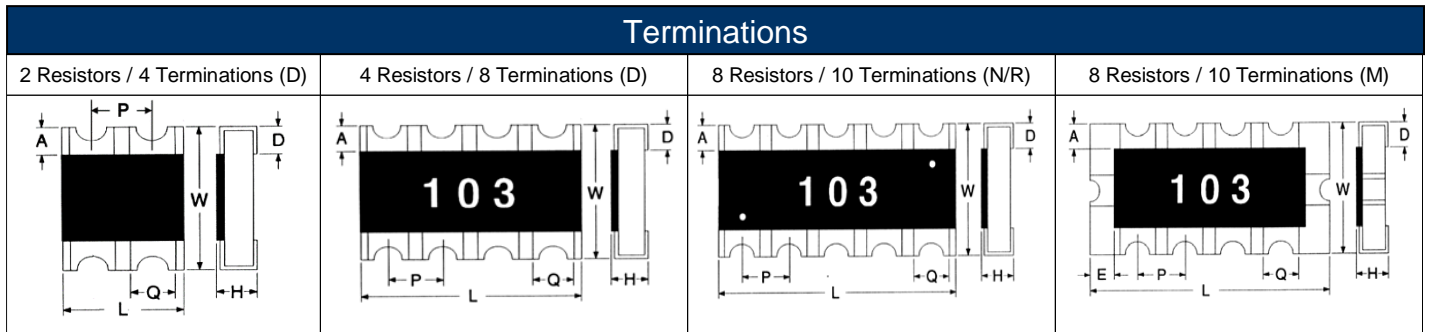
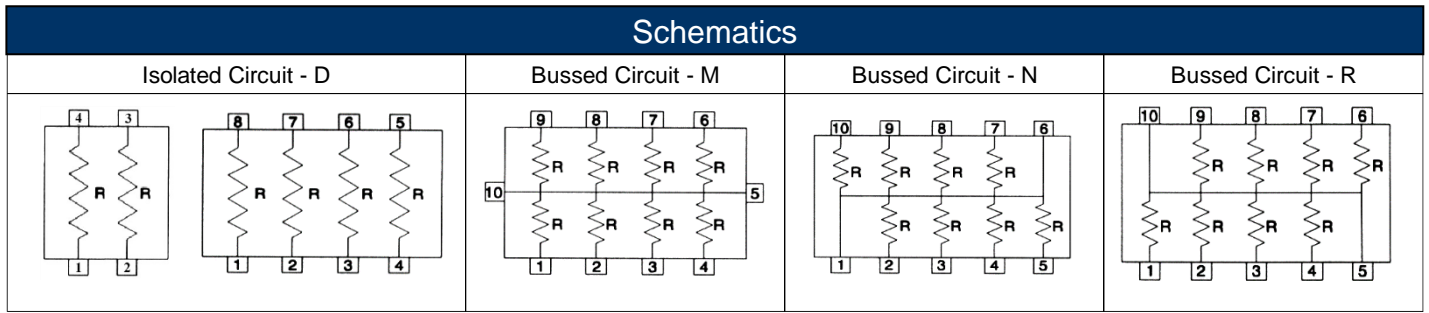

Mechanical Specifications

Type / Code / # of Elements / Circuit Type	L Body Length	W Body Width	H Body Height	P Element Spacing	Q Termination Width	D Bottom Termination	A Top Termination	E End Termination	Unit
RACF102D	0.039 ± 0.004 1.00 ± 0.10	0.039 ± 0.004 1.00 ± 0.10	0.012 ± 0.004 0.30 ± 0.10	0.020 0.50	0.012 ± 0.004 0.30 ± 0.10	0.010 ± 0.004 0.25 ± 0.10	0.007 ± 0.004 0.18 ± 0.10	-	inches mm
RACF104D	0.079 ± 0.004 2.00 ± 0.10	0.039 ± 0.004 1.00 ± 0.10	0.016 ± 0.000 0.40 ± 0.10	0.020 0.50	0.012 ± 0.004 0.30 ± 0.10	0.010 ± 0.004 0.25 ± 0.10	0.006 ± 0.004 0.15 ± 0.10	-	inches mm
RACF164D	0.126 ± 0.008 3.20 ± 0.20	0.063 ± 0.006 1.60 ± 0.15	0.024 ± 0.006 0.60 ± 0.15	0.031 0.80	0.016 ± 0.008 0.40 ± 0.20	0.016 ± 0.008 0.40 ± 0.20	0.012 ± 0.008 0.30 ± 0.20	-	inches mm
RACF324D	0.200 ± 0.008 5.08 ± 0.20	0.118 ± 0.008 3.00 ± 0.20	0.024 ± 0.004 0.60 ± 0.10	0.050 1.27	0.031 ± 0.004 0.80 ± 0.10	0.020 ± 0.008 0.50 ± 0.20	0.022 ± 0.008 0.55 ± 0.20	-	inches mm
RACF408M	0.157 ± 0.008 4.00 ± 0.20	0.083 ± 0.008 2.10 ± 0.20	0.024 ± 0.004 0.60 ± 0.10	0.031 0.80	0.020 ± 0.008 0.50 ± 0.20	0.016 ± 0.008 0.40 ± 0.20	0.010 ± 0.008 0.25 ± 0.20	0.012 ± 0.008 0.30 ± 0.20	inches mm
RACF648N	0.252 ± 0.008 6.40 ± 0.20	0.122 ± 0.008 3.10 ± 0.20	0.024 ± 0.004 0.60 ± 0.10	0.050 1.27	0.028 ± 0.008 0.70 ± 0.20	0.020 ± 0.008 0.50 ± 0.20	0.014 ± 0.006 0.35 ± 0.15	-	inches mm
RACF648R	0.252 ± 0.008 6.40 ± 0.20	0.122 ± 0.008 3.10 ± 0.20	0.024 ± 0.004 0.60 ± 0.10	0.050 1.27	0.028 ± 0.008 0.70 ± 0.20	0.020 ± 0.008 0.50 ± 0.20	0.014 ± 0.006 0.35 ± 0.15	-	inches mm

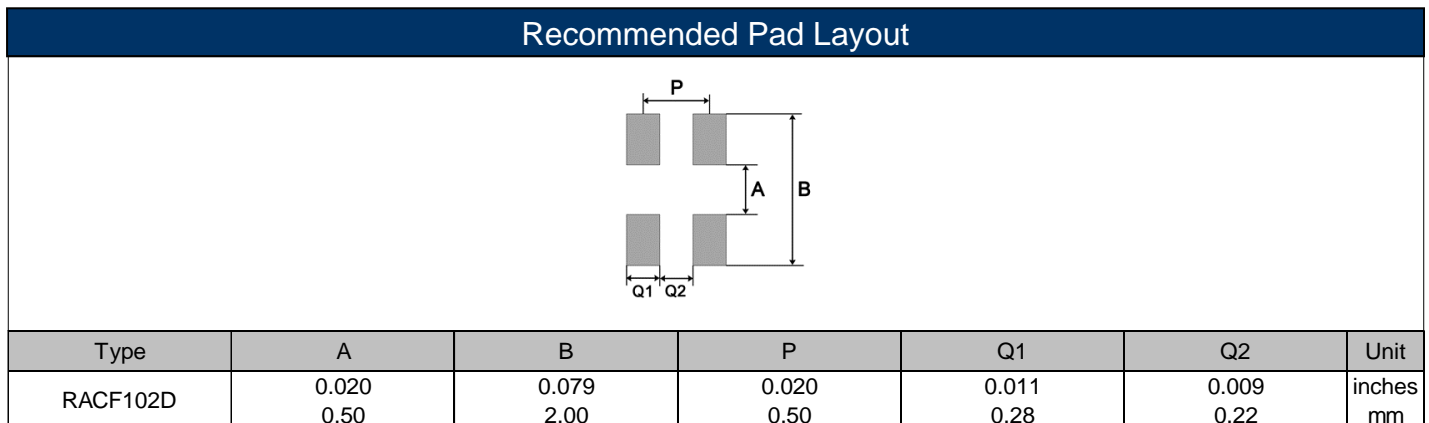

RACF Series (DISCONTINUED)
 Concave Termination Chip Resistor Array

Stackpole Electronics, Inc.
 Resistive Product Solutions

Recommended Pad Layout

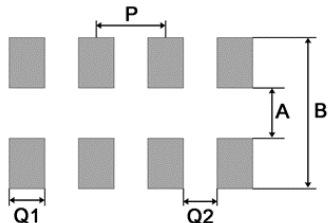

Type	A	B	P	Q1	Q2	Unit
RACF104D	0.020	0.079	0.020	0.011	0.009	inches
	0.50	2.00	0.50	0.28	0.22	mm

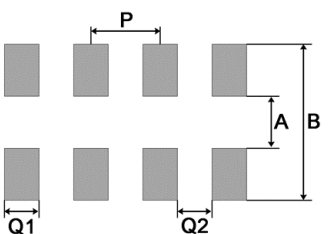

Type	A	B	P	Q1	Q2	Unit
RACF164D	0.031	0.102	0.031	0.020	0.012	inches
	0.80	2.60	0.80	0.50	0.30	mm
RACF324D	0.087	0.165	0.050	0.028	0.022	inches
	2.20	4.20	1.27	0.70	0.57	mm

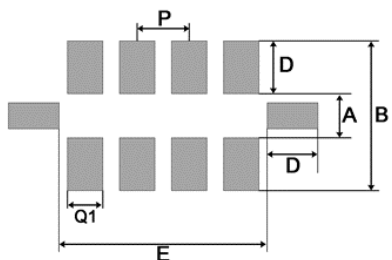

Type	A	B	D	E	P	Q1	Unit
RACF408M	0.039	0.118	0.039	0.134	0.031	0.020	inches
	1.00	3.00	1.00	3.40	0.80	0.50	mm

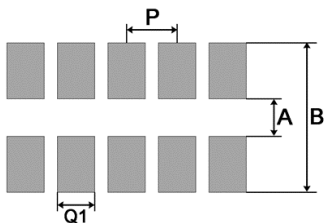

Type	A	B	P	Q1	Unit
RACF648N / 648R	0.031	0.122	0.050	0.028	inches
	0.80	3.10	1.27	0.70	mm

RACF Series (DISCONTINUED)

Concave Termination Chip Resistor Array

Stackpole Electronics, Inc.
Resistive Product Solutions

RoHS Compliance

Stackpole Electronics has joined the worldwide effort to reduce the amount of lead in electronic components and to meet the various regulatory requirements now prevalent, such as the European Union's directive regarding "Restrictions on Hazardous Substances" (RoHS 3). As part of this ongoing program, we periodically update this document with the status regarding the availability of our compliant components. All our standard part numbers are compliant to EU Directive 2011/65/EU of the European Parliament as amended by Directive (EU) 2015/863/EU as regards the list of restricted substances.

RoHS Compliance Status						
Standard Product Series	Description	Package / Termination Type	Standard Series RoHS Compliant	Lead-Free Termination Composition	Lead-Free Mfg. Effective Date (Std Product Series)	Lead-Free Effective Date Code (YY/WW)
RACF	Thick Film Surface Mount Chip Resistor Array Concave Terminations	SMD	YES(1)	100% Matte Sn over Ni	Jan-04	04/01

Note (1): RoHS Compliant by means of exemption 7c-l.

"Conflict Metals" Commitment

We at Stackpole Electronics, Inc. are joined with our industry in opposing the use of metals mined in the "conflict region" of the eastern Democratic Republic of the Congo (DRC) in our products. Recognizing that the supply chain for metals used in the electronics industry is very complex, we work closely with our own suppliers to verify to the extent possible that the materials and products we supply do not contain metals sourced from this conflict region. As such, we are in compliance with the requirements of Dodd-Frank Act regarding Conflict Minerals.

Compliance to "REACH"

We certify that all passive components supplied by Stackpole Electronics, Inc. are SVHC (Substances of Very High Concern) free and compliant with the requirements of EU Directive 1907/2006/EC, "The Registration, Evaluation, Authorization and Restriction of Chemicals", otherwise referred to as REACH. Contact us for complete list of REACH Substance Candidate List.

Environmental Policy

It is the policy of Stackpole Electronics, Inc. (SEI) to protect the environment in all localities in which we operate. We continually strive to improve our effect on the environment. We observe all applicable laws and regulations regarding the protection of our environment and all requests related to the environment to which we have agreed. We are committed to the prevention of all forms of pollution.

How to Order

R
A
C
F
1
6
4
D
J
T
1
0
K
0

Product Series		Power Rating		Tolerance		Packaging			Resistance Value	
Code	Description	Code	W	Code	Tol	Code	Description	Size	Quantity	
RACF	Concave RoHS	102D	0.063	F	1%	E24, E96	Reel - Paper Tape	102D, 104D	10000	Four characters with the multiplier used as the decimal holder. 1 ohm = 1R00 100 Kohm = 100K 1 Mohm = 1M00 Zero ohm jumper = 0R00
		104D	0.063	S	2%	E24		164D	5000	
		164D	0.063	J	5%		Reel - Plastic Tape	324D, 406M	4000	
		324D	0.125	Z	jumper			648N, 648R		
		408M	0.063							
		648N	0.063							
		648R	0.063							

D = Isolated
M, N, R = Bussed

OUR CERTIFICATE

DiGi provide top-quality products and perfect service for customer worldwide through standardization, technological innovation and continuous improvement. DiGi through third-party certification, we stricly control the quality of products and services. Welcome your RFQ to

Email: Info@DiGi-Electronics.com



Tel: +00 852-30501935

RFQ Email: Info@DiGi-Electronics.com

DiGi is a global authorized distributor of electronic components.