

RAVF164DFT1K00 Datasheet

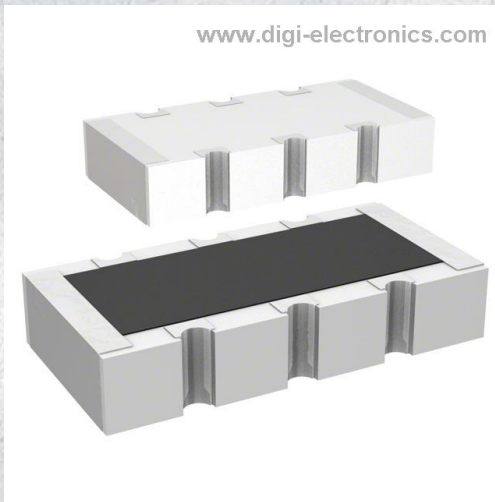

<https://www.DiGi-Electronics.com>

DiGi Electronics Part Number	RAVF164DFT1K00-DG
Manufacturer	Stackpole Electronics Inc
Manufacturer Product Number	RAVF164DFT1K00
Description	RES ARRAY 4 RES 1K OHM 1206
Detailed Description	1k Ohm $\pm 1\%$ 100mW Power Per Element Isolated 4 Resistor Network/Array ± 200 ppm/ $^{\circ}\text{C}$ 1206 (3216 Metric), Convex, Long Side Terminals

This model RAUF164DFT1K00 is available at DiGi Electronics.

DiGi Electronics offers a global database of semiconductor and electronic component datasheets.

We welcome your inquiries regarding pricing, lead time, or other product-related questions.

 [Request a Quote](#)

 [Datasheet Search](#)



Tel: +00 852-30501935

RFQ Email: Info@DiGi-Electronics.com

DiGi is a global authorized distributor of electronic components.

Purchase and inquiry

Manufacturer Product Number:

RAVF164DFT1K00

Series:

RAVF

Circuit Type:

Isolated

Tolerance:

±1%

Resistor Matching Ratio:

-

Number of Pins:

8

Temperature Coefficient:

±200ppm/°C

Applications:

Automotive AEC-Q200

Package / Case:

1206 (3216 Metric), Convex, Long Side Terminals

Size / Dimension:

0.126" L x 0.063" W (3.20mm x 1.60mm)

Manufacturer:

Stackpole Electronics Inc

Product Status:

Active

Resistance (Ohms):

1k

Number of Resistors:

4

Resistor-Ratio-Drift:

-

Power Per Element:

100mW

Operating Temperature:

-55°C ~ 155°C

Mounting Type:

Surface Mount

Supplier Device Package:

-

Height - Seated (Max):

0.024" (0.60mm)

Environmental & Export classification

RoHS Status:

ROHS3 Compliant

REACH Status:

REACH Unaffected

HTSUS:

8533.21.0020

Moisture Sensitivity Level (MSL):

1 (Unlimited)

ECCN:

EAR99

RAVF Series

Convex Termination Thick Film Chip Resistor Array

Stackpole Electronics, Inc.

Resistive Product Solutions

Features:

- Square corner construction standard
- RAVF 324D is standard with scalloped corner
- RoHS compliant, REACH compliant and halogen free
- Sizes 102D, 104D and 164D are AEC-Q200 compliant



Electrical Specifications

Type/Code, # of Elements, Circuit Type	Power Rating (W) (per element) @ 70°C	Maximum Working Voltage (V) ⁽¹⁾	Maximum Overload Voltage (V)	TCR (ppm/°C)	Ohmic Range (Ω) and Tolerance	
					1%	2%, 5%
RAVF102D	0.063	25	50	± 400	-	1 - 9.1
				± 200	10 - 1M	
	Jumper: 1A				0.025 max	0.05 max
RAVF104D	0.063	25	50	± 400	-	1 - 9.1
				± 200	10 - 1M	
	Jumper: 1A				0.025 max	0.05 max
RAVF162D	0.063	50	100	± 200	10 - 1M	1 - 1M
				-	-	0.05 max
RAVF164D	0.1	50	100	± 400	-	1 - 9.1
				± 200	10 - 1M	10 - 1M
	Jumper: 1A				0.025 max	0.05 max
RAVF324D	0.125	200	400	± 200	22 - 1M	10 - 1M
RAVF328N	0.063	25	50	± 200	-	22 - 1M
RAVF328R	0.063	25	50	± 200	-	22 - 1M

(1) Lesser of $\sqrt{P \cdot R}$ or maximum working voltage.

Power Derating Curve:

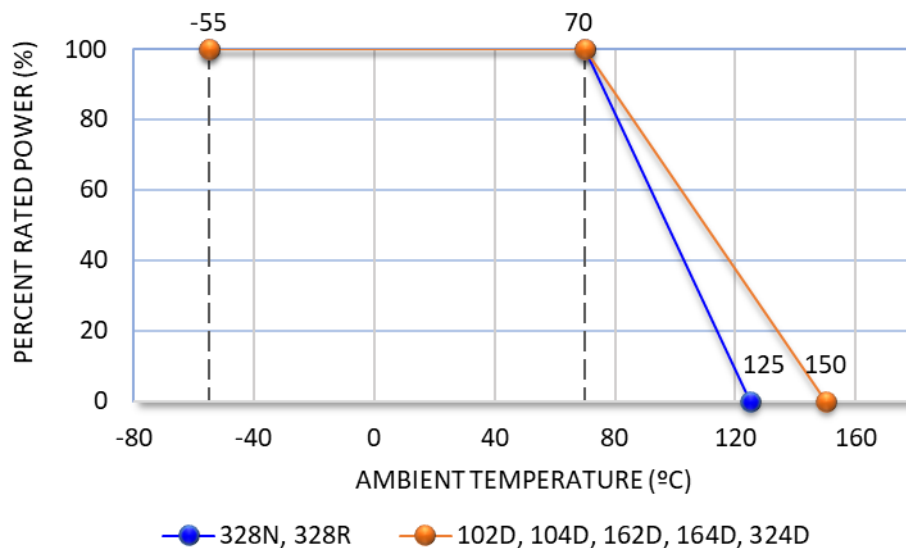

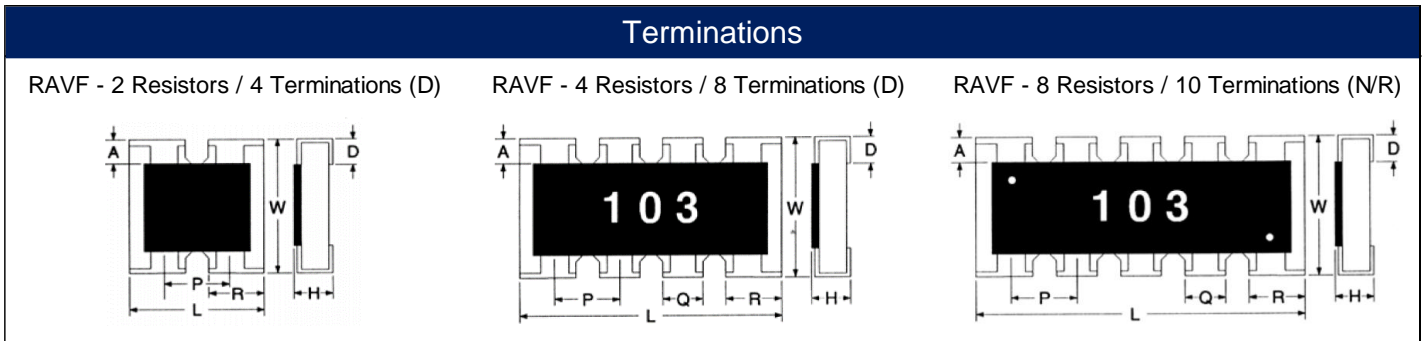
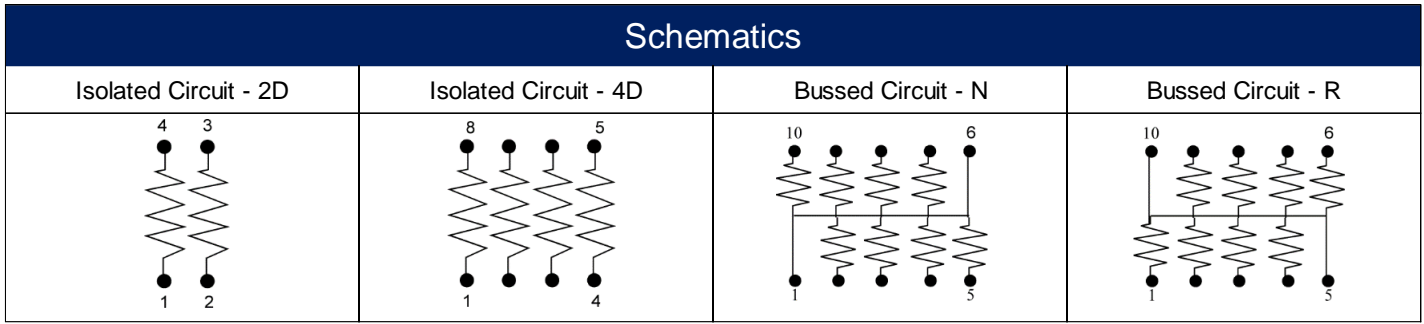

Mechanical Specifications

Type/Code # of Elements Circuit Type	L Body Length	W Body Width	H Body Height	P Element Spacing	Q Termination Width	R Termination Width	D Bottom Termination	A Top Termination	Unit
RAVF102D	0.039 ± 0.004 1.00 ± 0.10	0.039 ± 0.004 1.00 ± 0.10	0.014 ± 0.004 0.35 ± 0.10	0.026 ± 0.039 0.67 ± 1.00	- -	0.013 ± 0.004 0.34 ± 0.10	0.010 ± 0.039 0.25 ± 1.00	0.006 ± 0.004 0.15 ± 0.10	Inches mm
RAVF104D	0.079 ± 0.008 2.00 ± 0.20	0.039 ± 0.006 1.00 ± 0.15	0.014 ± 0.006 0.35 ± 0.15	0.020 ± 0.006 0.50 ± 0.15	0.012 ± 0.004 0.30 ± 0.10	0.017 ± 0.004 0.43 ± 0.10	0.008 +0.006/-0.004 0.20 +0.15/-0.10	0.008 ± 0.004 0.20 ± 0.10	Inches mm
RAVF162D	0.063 ± 0.006 1.60 ± 0.15	0.063 ± 0.006 1.60 ± 0.15	0.020 ± 0.006 0.50 ± 0.15	0.031 ± 0.002 0.80 ± 0.05	- -	0.024 ± 0.006 0.60 ± 0.15	0.012 ± 0.006 0.30 ± 0.15	0.012 ± 0.006 0.30 ± 0.15	Inches mm
RAVF164D	0.126 ± 0.008 3.20 ± 0.20	0.063 ± 0.008 1.60 ± 0.20	0.020 ± 0.004 0.50 ± 0.10	0.031 ± 0.008 0.80 ± 0.20	0.020 ± 0.006 0.50 ± 0.15	0.024 ± 0.006 0.61 ± 0.15	0.012 ± 0.008 0.30 ± 0.20	0.012 ± 0.008 0.30 ± 0.20	Inches mm
RAVF324D	0.201 ± 0.009 5.10 ± 0.22	0.122 ± 0.008 3.10 ± 0.20	0.022 ± 0.006 0.55 ± 0.15	0.051 ± 0.008 1.30 ± 0.20	0.031 ± 0.008 0.80 ± 0.20	0.031 ± 0.008 0.80 ± 0.20	0.022 ± 0.012 0.55 ± 0.30	0.020 ± 0.008 0.50 ± 0.20	Inches mm
RAVF328N	0.126 ± 0.006 3.20 ± 0.15	0.063 ± 0.006 1.60 ± 0.15	0.022 ± 0.004 0.55 ± 0.10	0.025 ± 0.002 0.64 ± 0.05	0.013 ± 0.006 0.34 ± 0.15	0.019 ± 0.006 0.49 ± 0.15	0.010 ± 0.006 0.25 ± 0.15	0.012 ± 0.008 0.30 ± 0.20	Inches mm
RAVF328R	0.126 ± 0.006 3.20 ± 0.15	0.063 ± 0.006 1.60 ± 0.15	0.022 ± 0.004 0.55 ± 0.10	0.025 ± 0.002 0.64 ± 0.05	0.013 ± 0.006 0.34 ± 0.15	0.019 ± 0.006 0.49 ± 0.15	0.010 ± 0.006 0.25 ± 0.15	0.012 ± 0.008 0.30 ± 0.20	Inches mm

Performance Characteristics

Test	Test Result (JIS C 5202)
Load Life in Moisture	±3%
Temperature cycle	±1%
Load Life	±3%
Resistance to Soldering heat	±1%
Terminal Adhesion	±1%
Short Time Overload	±2%

Operating temperature range is -55 to +155°C, except for RA VF328N and RA VF328R
 Operating temperature range for RA VF328N and RA VF328R is -55°C to +125°C

Recommended Pad Layout - 102D/162D

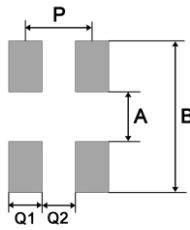

Type/Code	A	B	P	Q1	Q2	Unit
RAVF102D	0.020 0.50	0.079 2.00	0.026 0.67	0.013 0.33	0.013 0.34	Inches mm
RAVF162D	0.039 1.00	0.102 2.60	0.031 0.80	0.016 0.40	0.016 0.40	Inches mm

Recommended Pad Layout - 104D

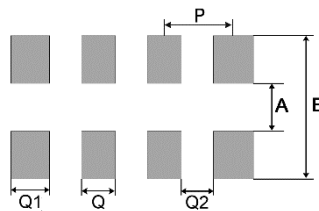

Type/Code	A	B	P	Q	Q1	Q2	Unit
RAVF104D	0.020 0.50	0.079 2.00	0.020 0.50	0.012 0.30	0.016 0.40	0.008 0.20	Inches mm

Recommended Pad Layout - 164D/324D

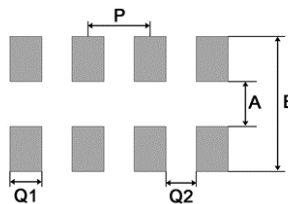

Type/Code	A	B	P	Q1	Q2	Unit
RAVF164D	0.039 1.00	0.102 2.60	0.031 0.80	0.016 0.40	0.016 0.40	Inches mm
RAVF324D	0.079 2.00	0.187 4.75	0.051 1.30	0.035 0.90	0.015 0.38	Inches mm

Recommended Pad Layout - 328R

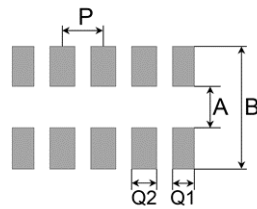

Type/Code	A	B	P	Q1	Q2	Unit
RAVF328R	0.031 0.80	0.122 3.10	0.025 0.64	0.013 0.34	0.018 0.45	Inches mm

Recommended Solder Profile

This information is intended as a reference for solder profiles for Stackpole resistive components. These profiles should be compatible with most soldering processes. These are only recommendations. Actual numbers will depend on board density, geometry, packages used, etc., especially those cells labeled with “**”.

100% Matte Tin / RoHS Compliant Terminations

Soldering iron recommended temperatures: 330 to 350°C with minimum duration.
Maximum number of reflow cycles: 3.

Wave Soldering

Description	Maximum	Recommended	Minimum
Preheat Time	80 seconds	70 seconds	60 seconds
Temperature Diff.	140°C	120°C	100°C
Solder Temp.	260°C	250°C	240°C
Dwell Time at Max.	10 seconds	5 seconds	*
Ramp DN (°C/sec)	N/A	N/A	N/A

Temperature Diff. = Difference between final preheat stage and soldering stage.

Convection IR Reflow

Description	Maximum	Recommended	Minimum
Ramp Up (°C/sec)	3°C/sec	2°C/sec	*
Dwell Time > 217°C	150 seconds	90 seconds	60 seconds
Solder Temp.	260°C	245°C	*
Dwell Time at Max.	30 seconds	15 seconds	10 seconds
Ramp DN (°C/sec)	6°C/sec	3°C/sec	*

Recommended Resistor Reflow Profile



RoHS Compliance

Stackpole Electronics has joined the worldwide effort to reduce the amount of lead in electronic components and to meet the various regulatory requirements now prevalent, such as the European Union's directive regarding "Restrictions on Hazardous Substances" (RoHS 3). As part of this ongoing program, we periodically update this document with the status regarding the availability of our compliant components. All our standard part numbers are compliant to EU Directive 2011/65/EU of the European Parliament as amended by Directive (EU) 2015/863/EU as regards the list of restricted substances.

RoHS Compliance Status

Standard Product Series	Description	Package / Termination Type	Standard Series RoHS Compliant	Lead-Free Termination Composition	Lead-Free Mfg. Effective Date (Std Product Series)	Lead-Free Effective Date Code (YY/WW)
RAVF	Convex Termination Thick Film Chip Resistor Array	SMD	YES(1)	100% Matte Sn over Ni	Jan-04 (Japan) Jul-04 (Taiwan)	04/01 04/27

Note (1): RoHS Compliant by means of exemption 7c-l.

"Conflict Metals" Commitment

We at Stackpole Electronics, Inc. are joined with our industry in opposing the use of metals mined in the "conflict region" of the eastern Democratic Republic of the Congo (DRC) in our products. Recognizing that the supply chain for metals used in the electronics industry is very complex, we work closely with our own suppliers to verify to the extent possible that the materials and products we supply do not contain metals sourced from this conflict region. As such, we are in compliance with the requirements of Dodd-Frank Act regarding Conflict Minerals.

Compliance to "REACH"

We certify that all passive components supplied by Stackpole Electronics, Inc. are SVHC (Substances of Very High Concern) free and compliant with the requirements of EU Directive 1907/2006/EC, "The Registration, Evaluation, Authorization and Restriction of Chemicals", otherwise referred to as REACH. Contact us for complete list of REACH Substance Candidate List.

RAVF Series

Convex Termination Thick Film Chip Resistor Array

Stackpole Electronics, Inc.
Resistive Product Solutions

Environmental Policy

It is the policy of Stackpole Electronics, Inc. (SEI) to protect the environment in all localities in which we operate. We continually strive to improve our effect on the environment. We observe all applicable laws and regulations regarding the protection of our environment and all requests related to the environment to which we have agreed. We are committed to the prevention of all forms of pollution.

How to Order

R	A	V	F	1	6	4	D	J	T	1	0	K	0
---	---	---	---	---	---	---	---	---	---	---	---	---	---

Product Series		Size		Tolerance ⁽¹⁾			Packaging				Resistance Value				
Code	Description	Code	W	Code	Tol	Value	Code	Description	Size	Quantity					
RAVF	Convex Termination	102D	0.063	F	1%	E24	T	Tape and Reel	102D, 104D	10000	Four characters with the multiplier used as the decimal holder. 10 ohm = 10R0 10.2 Kohm = 10K2 1 Mohm = 1M00 Zero ohm jumper = 0R00				
		104D	0.063	G	2%				162D, 164D	5000					
		162D	0.063	J	5%				328N, 328R	4000					
		164D	0.1	Z	jumper				324D	4000					
		324D	0.125												
		328N	0.063												
328R	0.063														

Note (1): 1% tolerance is available in E24 values only.
E96 values are generally not available. Contact Stackpole for details.

OUR CERTIFICATE

DiGi provide top-quality products and perfect service for customer worldwide through standardization, technological innovation and continuous improvement. DiGi through third-party certification, we strictly control the quality of products and services. Welcome your RFQ to

Email: Info@DiGi-Electronics.com



Tel: +00 852-30501935

RFQ Email: Info@DiGi-Electronics.com

DiGi is a global authorized distributor of electronic components.