

# RSPF2FA33K2 Datasheet



DiGi Electronics Part Number	RSPF2FA33K2-DG
Manufacturer	<a href="#">Stackpole Electronics Inc</a>
Manufacturer Product Number	RSPF2FA33K2
Description	RES 33.2K OHM 1% 2W AXIAL
Detailed Description	33.2 kOhms ±1% 2W Through Hole Resistor Axial Flame Proof, Moisture Resistant, Safety Metal Oxide Film

<https://www.DiGi-Electronics.com>

This model RSPF2FA33K2 is available at DiGi Electronics.

DiGi Electronics offers a global database of semiconductor and electronic component datasheets.

We welcome your inquiries regarding pricing, lead time, or other product-related questions.

 [Request a Quote](#)

 [Datasheet Search](#)



Tel: +00 852-30501935

RFQ Email: [Info@DiGi-Electronics.com](mailto:Info@DiGi-Electronics.com)

DiGi is a global authorized distributor of electronic components.

## Purchase and inquiry

Manufacturer Product Number:

RSPF2FA33K2

Series:

RSPF

Resistance:

33.2 kOhms

Power (Watts):

2W

Features:

Flame Proof, Moisture Resistant, Safety

Operating Temperature:

-55°C ~ 155°C

Supplier Device Package:

Axial

Height - Seated (Max):

-

Failure Rate:

-

Manufacturer:

Stackpole Electronics Inc

Product Status:

Active

Tolerance:

±1%

Composition:

Metal Oxide Film

Temperature Coefficient:

-200/ +350ppm/°C

Package / Case:

Axial

Size / Dimension:

0.157" Dia x 0.433" L (4.00mm x 11.00mm)

Number of Terminations:

2

## Environmental & Export classification

RoHS Status:

ROHS3 Compliant

REACH Status:

REACH Unaffected

HTSUS:

8533.21.0090

Moisture Sensitivity Level (MSL):

Not Applicable

ECCN:

EAR99

# RSPF / RSPL Series

## Flameproof Power Resistor

Stackpole Electronics, Inc.  
Resistive Product Solutions

### Features:

- Robust metal oxide film element
- Flameproof design
- Compact size
- Useful in circuits where duty cycles require power resistors
- Tin-plated copper leads
- Cut and formed product is available on select sizes - contact Stackpole for details
- 100% RoHS compliant and lead free without exemption
- Halogen free
- REACH compliant



### Electrical Specifications - RSPF

Type / Code	Power Rating (W) @ 70°C	Maximum Working Voltage (V) <sup>(1)</sup>	Maximum Overload Voltage (V)	TCR (ppm/°C)	Ohmic Range (Ω) and Tolerance	
					1%, 2%	5%
RSPF14	0.25	250	500	- 200 ~ + 350	10 - 100K	2.2 - 1M
RSPF12	0.5	400	800			
RSPF1	1	500	1000			
RSPF2	2	500	1000			
RSPF3	3	500	1000			

### Electrical Specifications - RSPL

Type / Code	Power Rating (W) @ 70°C	Maximum Working Voltage (V) <sup>(1)</sup>	Maximum Overload Voltage (V)	TCR (ppm/°C)	Ohmic Range (Ω) and Tolerance	
					1%, 2%	5%
RSPL14	0.25	$\sqrt{P \cdot R}$	$\sqrt{P \cdot R} \times 2.5$	- 200 ~ + 350	-	0.1 - 2
RSPL12	0.5					
RSPL1	1					
RSPL2	2					
RSPL3	3					

(1) Lesser of  $\sqrt{P \cdot R}$  or maximum working voltage

### Mechanical Specifications

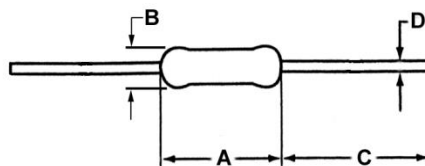

Type / Code	A Body Length	B Body Diameter	C Lead Length (Bulk)	D Lead Diameter	Unit
RSPF14 / RSPL14	0.13 +0.008 / - 3.20 +0.20 / -0	0.07 ± 0.01 1.82 ± 0.20	1.10 ± 0.12 28.00 ± 3.00	0.02 ± 0.002 0.45 ± 0.05	inches mm
RSPF12 / RSPL12	0.24 ± 0.020 6.00 ± 0.50	0.09 ± 0.01 2.30 ± 0.20	1.10 ± 0.12 28.00 ± 3.00	0.02 ± 0.002 0.55 ± 0.05	inches mm
RSPF1 / RSPL1	0.35 ± 0.039 9.00 ± 1.00	0.12 ± 0.02 3.00 ± 0.50	1.10 ± 0.12 28.00 ± 3.00	0.03 ± 0.002 0.70 ± 0.05	inches mm
RSPF2 / RSPL2	0.43 ± 0.039 11.00 ± 1.00	0.16 ± 0.02 4.00 ± 0.50	1.10 ± 0.12 28.00 ± 3.00	0.03 ± 0.002 0.80 ± 0.05	inches mm
RSPF3 / RSPL3	0.59 ± 0.039 15.00 ± 1.00	0.22 ± 0.04 5.50 ± 1.00	1.38 ± 0.12 35.00 ± 3.00	0.03 ± 0.002 0.80 ± 0.05	inches mm

### Performance Characteristics

Test	Test Results
Short Time Overload	± (0.75% + 0.05Ω)
Moisture Resistance	± (5% + 0.05Ω)
Load Life @ 70°C - 1000 hours	± (5% + 0.05Ω)
Dielectric Withstanding Voltage	± (5% + 0.05Ω)
Resistance to Solvent	Permanent marking no physical damage or deterioration

Operating temperature range is -55°C to +155°C

### Power Derating Curve:

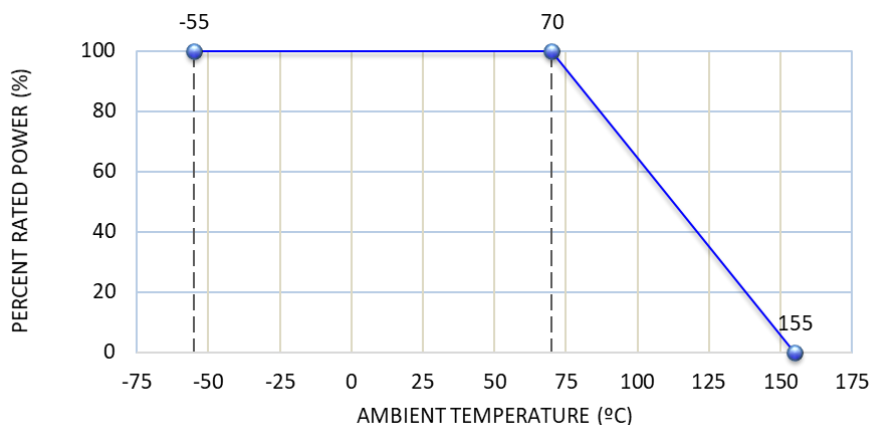

### Repetitive Pulse Information:

If repetitive pulses are applied to resistors, pulse wave form must be less than “pulse limiting voltage”, “pulse limiting current” or “pulse limiting wattage” calculated by the formula below.

$$V_p = K\sqrt{P \times R \times T/t}$$

$$I_p = K\sqrt{P/R \times T/t}$$

$$P_p = K^2 \times P \times T/t$$

Where:  $V_p$ : Pulse limiting voltage (V)  
 $I_p$ : Pulse limiting current (A)  
 $P_p$ : Pulse limiting wattage (W)  
 $P$ : Power rating (W)  
 $R$ : Nominal resistance (ohm)  
 $T$ : Repetitive period (sec)  
 $t$ : Pulse duration (sec)  
 $K$ : Coefficient: 0.9  
 $[V_r$ : Rated Voltage (V),  $I_r$ : Rated Current (A)]

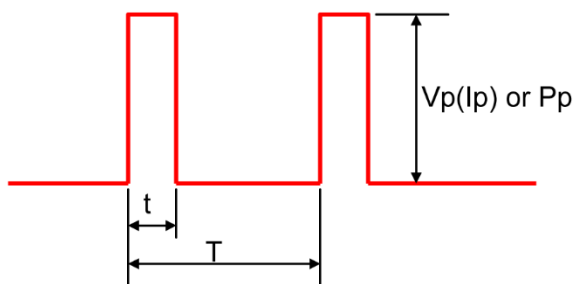

Note 1: If  $T > 10 \rightarrow T = 10$  (sec),  $T/t > 1000 \rightarrow T/t = 1000$

Note 2: If  $T > 10$  and  $T/t > 1000$ , “Pulse Limiting power (Single pulse) is applied”

Note 3: If  $V_p < V_r$  ( $I_p < I_r$  or  $P_p < P$ ),  $V_r$  ( $I_r$ ,  $P$ ) is  $V_p$  ( $I_p$ ,  $P_p$ )

Note 4: Pulse limiting voltage (current, wattage) is applied at less than rated ambient temperature.

If ambient temperature is more than the rated temperature (70°C), decrease power rating according to “Power Derating Curve”

Note 5: Assure sufficient margin for use period and conditions for “pulse limiting voltage”

Note 6: If the pulse waveform is not square wave, judge after transform the waveform into square wave according to the “Waveform Transformation to Square Wave”.

### Waveform Transformation to Square Wave

1. Discharge curve wave with time constant "t" → Square wave

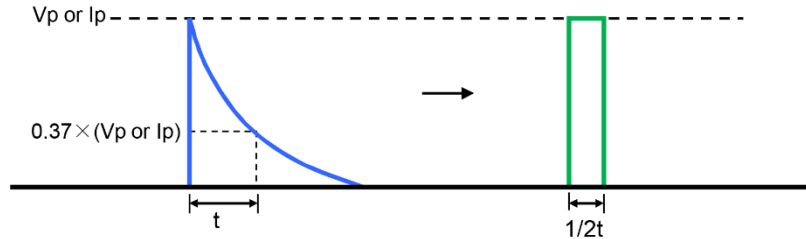

2. Damping oscillation wave with time constant of envelope "t" → Square wave

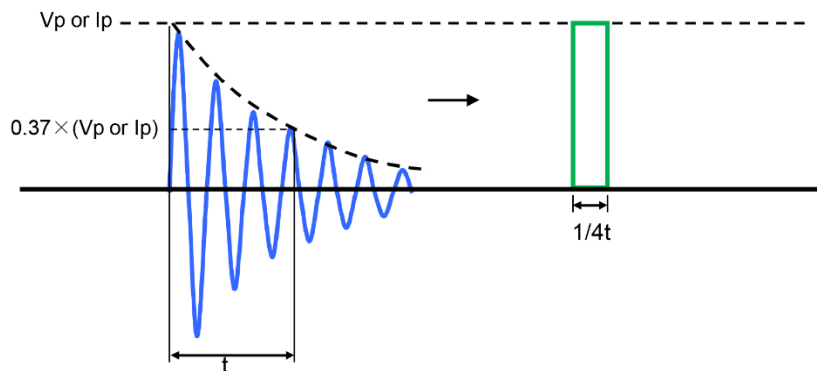

3. Half-wave rectification wave → Square wave

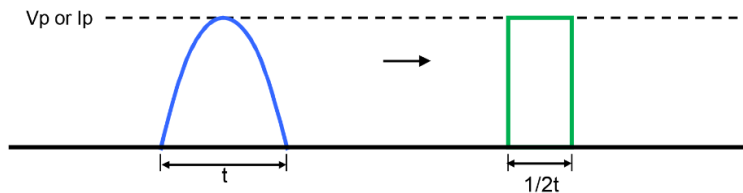

4. Triangular wave → Square wave

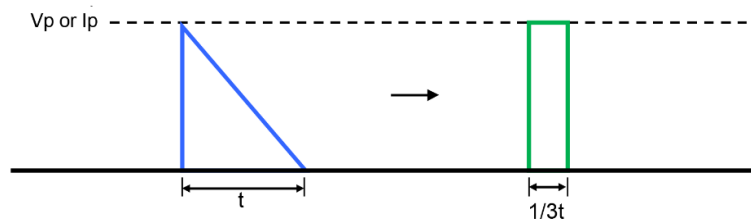

5. Special wave → Square wave

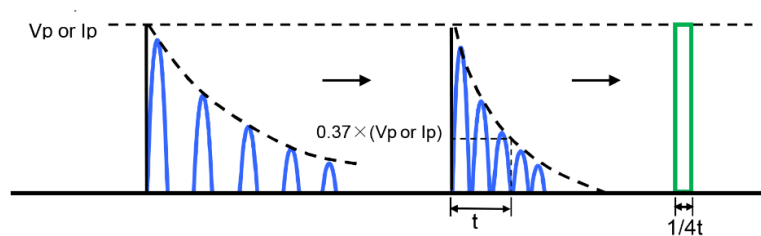

# RSPF / RSPL Series

## Flameproof Power Resistor

Stackpole Electronics, Inc.  
Resistive Product Solutions

### Recommended Soldering Conditions

Flow Soldering:  
 - Pre-heating: 110°C MAX  
 - Peak temperature/duration: 260°C within 10 seconds (1<sup>st</sup>, 2<sup>nd</sup> wave total)  
 - Temperature profile (see chart on the right)

Iron Soldering:  
 - 380°C, 5 seconds, once/terminal

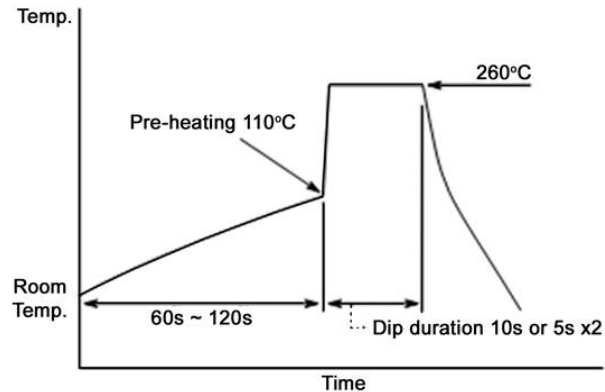

### Packaging Specifications

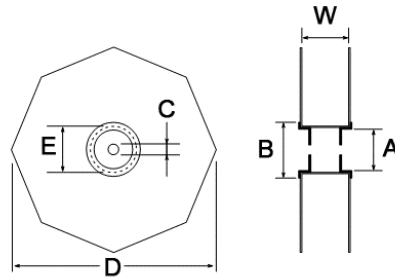

Type / Code	A	B	C	D	E	W	Unit
RSPF / RSPL	2.362 ± 0.079 60.00 ± 2.00	3.150 ± 0.079 80.00 ± 2.00	0.591 ± 0.039 15.00 ± 1.00	11.811 ± 0.197 300.00 ± 5.00	2.756 ± 0.079 70.00 ± 2.00	2.756 ± 0.079 70.00 ± 2.00	inches mm

### RoHS Compliance

Stackpole Electronics has joined the worldwide effort to reduce the amount of lead in electronic components and to meet the various regulatory requirements now prevalent, such as the European Union's directive regarding "Restrictions on Hazardous Substances" (RoHS 3). As part of this ongoing program, we periodically update this document with the status regarding the availability of our compliant components. All our standard part numbers are compliant to EU Directive 2011/65/EU of the European Parliament as amended by Directive (EU) 2015/863/EU as regards the list of restricted substances.

### RoHS Compliance Status

Standard Product Series	Description	Package / Termination Type	Standard Series RoHS Compliant	Lead-Free Termination Composition	Lead-Free Mfg. Effective Date (Std Product Series)	Lead-Free Effective Date Code (YY/WW)
RSPF	Flameproof Power Leded Resistor	Axial	YES	99.3/0.7 Sn/Cu	Apr-05	05/14
RSPL	Flameproof Power Leded Resistor Low Resistance	Axial	YES	99.3/0.7 Sn/Cu	Apr-05	05/14

# RSPF / RSPL Series

## Flameproof Power Resistor

Stackpole Electronics, Inc.  
Resistive Product Solutions

### “Conflict Metals” Commitment

We at Stackpole Electronics, Inc. are joined with our industry in opposing the use of metals mined in the “conflict region” of the Eastern Democratic Republic of the Congo (DRC) in our products. Recognizing that the supply chain for metals used in the electronics industry is very complex, we work closely with our own suppliers to verify to the extent possible that the materials and products we supply do not contain metals sourced from this conflict region. As such, we are in compliance with the requirements of Dodd-Frank Act regarding Conflict Minerals.

### Compliance to “REACH”

We certify that all passive components supplied by Stackpole Electronics, Inc. are SVHC (Substances of Very High Concern) free and compliant with the requirements of EU Directive 1907/2006/EC, “The Registration, Evaluation, Authorization and Restriction of Chemicals”, otherwise referred to as REACH. Contact us for complete list of REACH Substance Candidate List.

### Environmental Policy

It is the policy of Stackpole Electronics, Inc. (SEI) to protect the environment in all localities in which we operate. We continually strive to improve our effect on the environment. We observe all applicable laws and regulations regarding the protection of our environment and all requests related to the environment to which we have agreed. We are committed to the prevention of all forms of pollution.

## How to Order

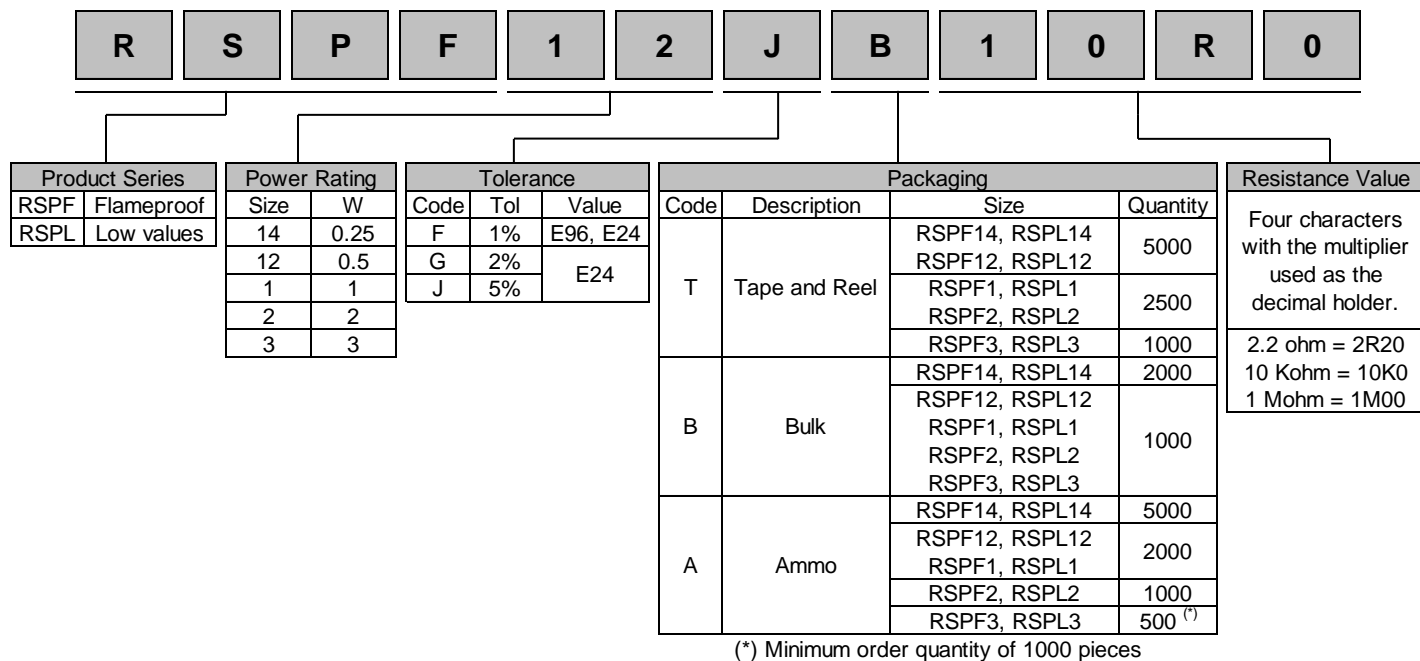

## OUR CERTIFICATE

DiGi provide top-quality products and perfect service for customer worldwide through standardization, technological innovation and continuous improvement. DiGi through third-party certification, we strictly control the quality of products and services. Welcome your RFQ to

Email: [Info@DiGi-Electronics.com](mailto:Info@DiGi-Electronics.com)



Tel: +00 852-30501935

RFQ Email: [Info@DiGi-Electronics.com](mailto:Info@DiGi-Electronics.com)

DiGi is a global authorized distributor of electronic components.