

ESDA6V1-5SC6Y Datasheet

www.digi-electronics.com

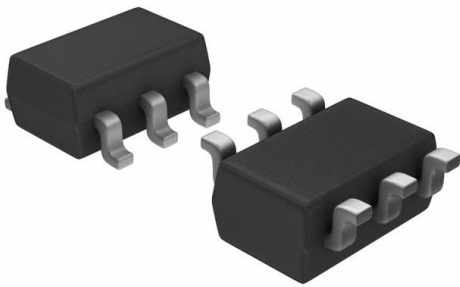

<https://www.DiGi-Electronics.com>

DiGi Electronics Part Number	ESDA6V1-5SC6Y-DG
Manufacturer	STMicroelectronics
Manufacturer Product Number	ESDA6V1-5SC6Y
Description	TVS DIODE 5.2VWM 11.4VC SOT23-6
Detailed Description	11.4V Clamp 7A (8/20μs) Ipp Tvs Diode Surface Mount SOT-23-6

This model ESDA6V1-5SC6Y is available at DiGi Electronics.

DiGi Electronics offers a global database of semiconductor and electronic component datasheets.

We welcome your inquiries regarding pricing, lead time, or other product-related questions.

 [Request a Quote](#)

 [Datasheet Search](#)



Tel: +00 852-30501935

RFQ Email: Info@DiGi-Electronics.com

DiGi is a global authorized distributor of electronic components.

Purchase and inquiry

Manufacturer Product Number:

ESDA6V1-5SC6Y

Series:

ESDA

Type:

Zener

Voltage - Reverse Standoff (Typ):

5.2V

Voltage - Clamping (Max) @ Ipp:

11.4V

Power - Peak Pulse:

80W

Applications:

-

Operating Temperature:

-40°C ~ 150°C (TJ)

Qualification:

AEC-Q101

Package / Case:

SOT-23-6

Base Product Number:

ESDA6

Manufacturer:

STMicroelectronics

Product Status:

Active

Unidirectional Channels:

5

Voltage - Breakdown (Min):

6.1V

Current - Peak Pulse (10/1000µs):

7A (8/20µs)

Power Line Protection:

No

Capacitance @ Frequency:

-

Grade:

Automotive

Mounting Type:

Surface Mount

Supplier Device Package:

SOT-23-6

Environmental & Export classification

RoHS Status:

ROHS3 Compliant

REACH Status:

REACH Unaffected

HTSUS:

8541.10.0080

Moisture Sensitivity Level (MSL):

1 (Unlimited)

ECCN:

EAR99

Automotive 5 lines TVS for ESD protection

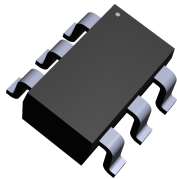

SOT23-6L

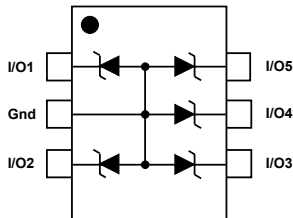

Features

- AEC-Q101 qualified 
- 5 unidirectional TVS functions
- UL 94, V0
- J-STD-020 MSL level 1
- Benefit:
 - Suitable for high density boards
- Complies with the standard ISO 10605 / IEC 61000-4-2: C = 150 pF, R = 330 Ω
 - ±30 kV (air discharge)
 - ±18 kV (contact discharge)
- Complies with the standard ISO 10605: C = 330 pF, R = 330 Ω
 - ±20 kV (air discharge)
 - ±13 kV (contact discharge)
- Complies with the standard ISO 7637-3
 - Pulse 3a: VS = -150 V
 - Pulse 3b: VS = +100 V

Applications

Where ESD and EOS transient overvoltage protection in susceptible equipment is required, such as:

- Information - entertainment
- Signal communications
- Connectivity
- Comfort and convenience

Description

The **ESDA6V1-5SC6Y** is a monolithic voltage suppressor designed to protect components which are connected to data and transmission lines against ESD.

It clamps the voltage just above the logic level supply for positive transients, and to a diode drop below ground for negative transient.

Product status link

[ESDA6V1-5SC6Y](#)

Product summary

Order code	ESDA6V1-5SC6Y
Package	SOT23-6L
Packing	Tape and reel

1 Characteristics

Table 1. Absolute ratings ($T_{amb} = 25\text{ }^{\circ}\text{C}$)

Symbol	Parameter	Value	Unit	
V_{PP}	Peak pulse voltage	ISO 10605 / IEC 61000-4-2 (C = 150 pF, R = 330 Ω)	18	kV
		Contact discharge		
		Air discharge	30	
		ISO 10605 (C = 330 pF, R = 330 Ω)	13	
Contact discharge				
	Air discharge	20		
P_{PP}	Peak pulse power dissipation (8/20 μs), T_j initial = T_{amb}	80	W	
I_{PP}	Peak pulse current (8/20 μs)	7	A	
T_{sig}	Storage temperature range	-65 to +150	$^{\circ}\text{C}$	
T_j	Operating junction temperature range	-40 to +150	$^{\circ}\text{C}$	
T_L	Maximum temperature for soldering during 10 s	260	$^{\circ}\text{C}$	

Figure 1. Electrical characteristics (definitions)

Symbol	Parameter
V_{BR}	Breakdown voltage
I_{RM}	Leakage current @ V_{RM}
V_{RM}	Stand-off voltage
V_{CL}	Clamping voltage
I_{PP}	Peak pulse current
I_F	Forward current
V_F	Forward voltage
R_d	Dynamic impedance
C_{LINE}	Line capacitance

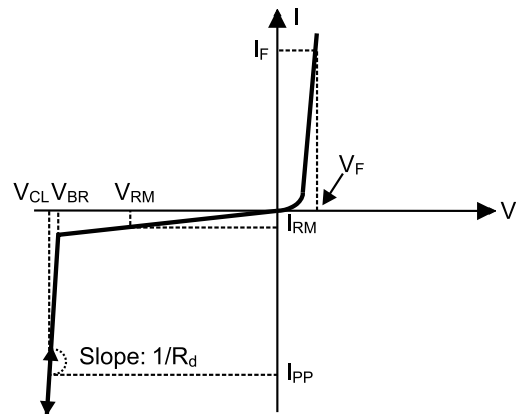
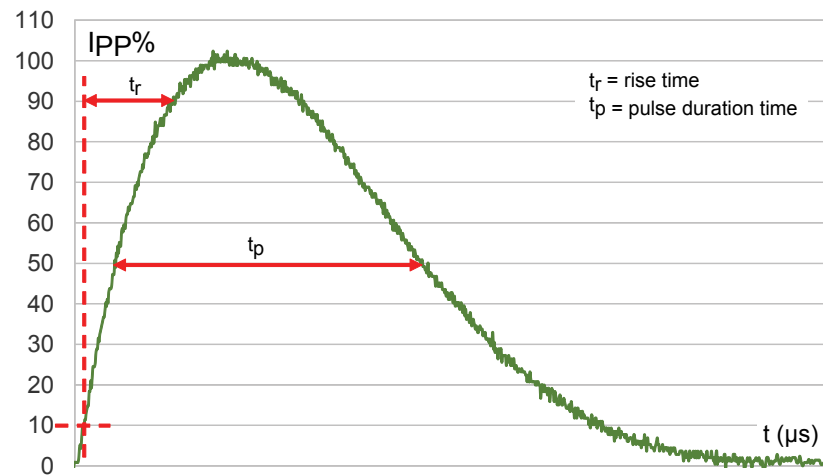

Table 2. Electrical characteristics - values ($T_{amb} = 25\text{ }^{\circ}\text{C}$)

Order code	V_{BR} at I_R			I_{RM} at V_{RM}		V_{CL} at $I_{pp}^{(1)}$		V_F at I_F		$\alpha T^{(2)}$	C_{line}
	Min.	Max.		Max.		Max.		Max.		Max.	Typ.
	V	V	mA	μA	V	V	A	V	mA	$10^{-4}/\text{C}$	pF
ESDA6V1-5SC6Y	6.1	7.2	1	1	5.2	11.4	7	1.25	200	6	50

1. 8/20 μs waveform

2. V_{BR} at $T_j = V_{BR}$ at $25\text{ }^{\circ}\text{C} \times (1 + \alpha T \times (T_j - 25))$

Figure 2. Pulse definition for electrical characteristics





1.1 Characteristics (curves)

Figure 3. Pulse power versus junction temperature

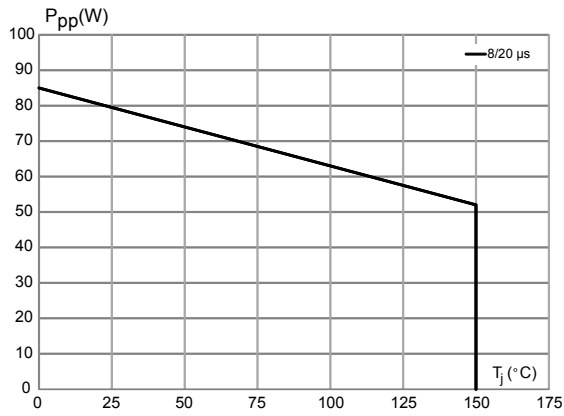

Figure 4. Peak pulse power versus exponential pulse duration

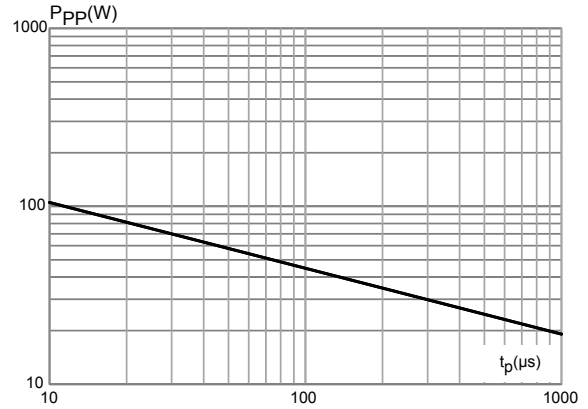

Figure 5. Clamping voltage versus peak pulse current

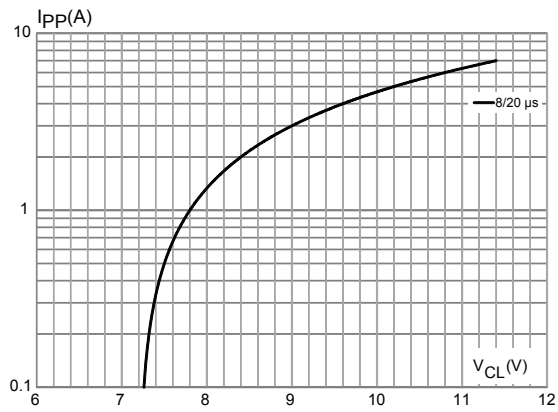

Figure 6. Leakage current versus junction temperature

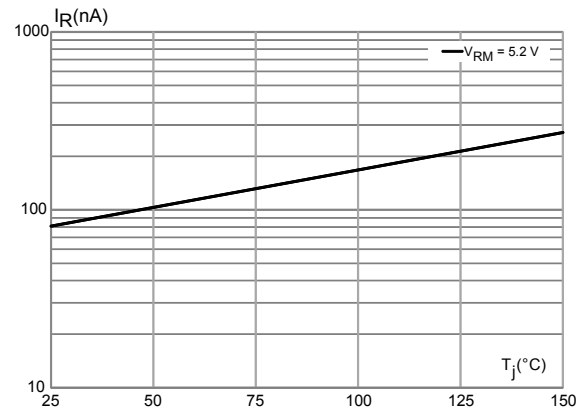



Figure 7. ESD response to IEC 61000-4-2 (+8 kV contact discharge)

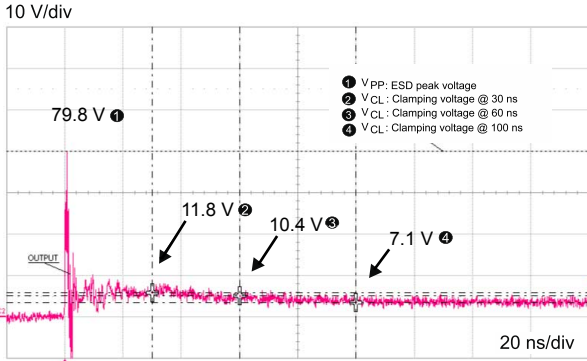

Figure 8. ESD response to IEC 61000-4-2 (-8 kV contact discharge)

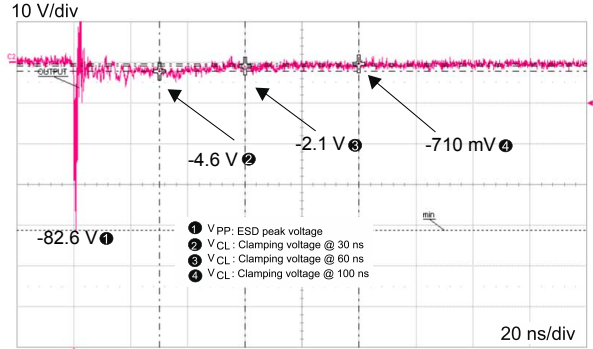

Figure 9. ISO7637-3 pulse 3a response (V_S = -150 V)

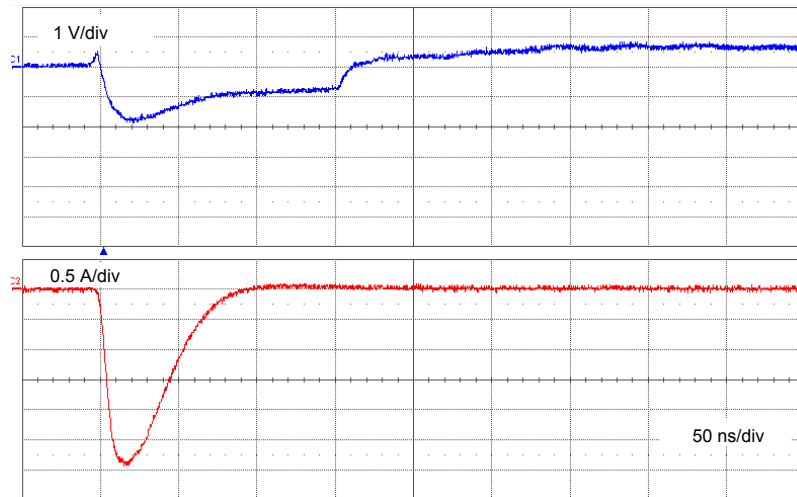
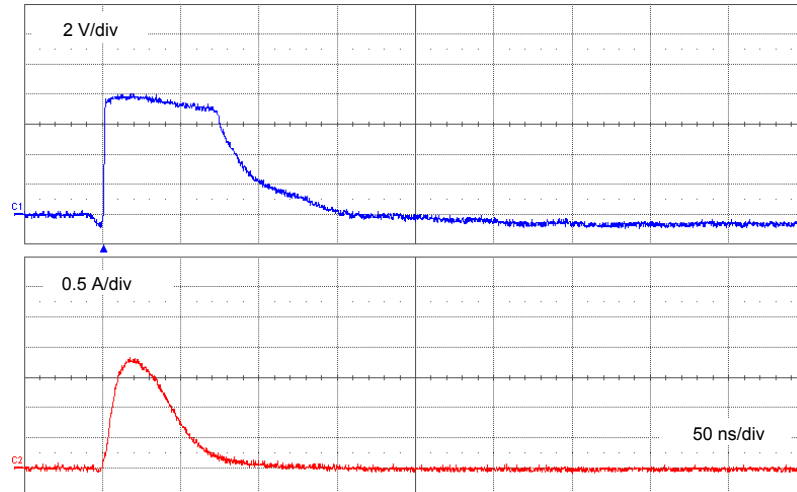

Figure 10. ISO7637-3 pulse 3b response (V_S = 100 V)





2 Application and design guidelines

Further information can be found in AN2689 titled: "Protection of automotive electronics from electrical hazards, guidelines for design and component selection".

3 Package information

In order to meet environmental requirements, ST offers these devices in different grades of **ECOPACK®** packages, depending on their level of environmental compliance. ECOPACK® specifications, grade definitions and product status are available at: www.st.com. ECOPACK® is an ST trademark.

3.1 SOT23-6L package information

- Epoxy meets UL 94,V0
- Lead-free package

Figure 11. SOT23-6L package outline

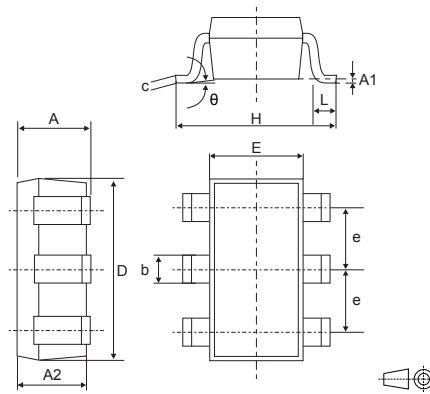

Table 3. SOT23-6L package mechanical data

Ref.	Dimensions					
	Millimeters			Inches		
	Min.	Typ.	Max.	Min.	Typ.	Max.
A	0.9		1.45	0.0354		0.0571
A1	0		0.15	0		0.0059
A2	0.9		1.3	0.0354		0.0512
b	0.30		0.5	0.0118		0.0197
c	0.09		0.2	0.0035		0.0079
D	2.8		3.05	0.1102		0.1201
E	1.5		1.75	0.0591		0.0689
e		0.95			0.0374	
H	2.6		3	0.1024		0.1181
L	0.3		0.6	0.0118		0.0236
θ	0		10	0		0.3937

Figure 12. Footprint recommendations, dimensions in mm (inches)

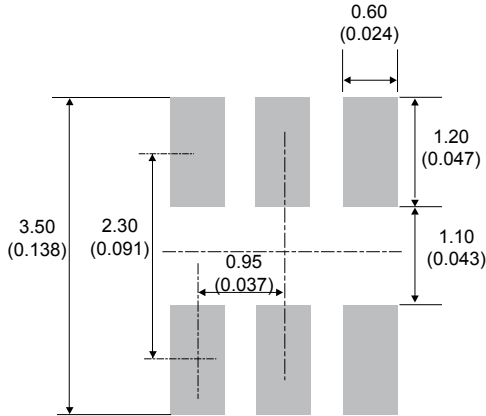

Figure 13. Marking layout (refer to ordering information table for marking)

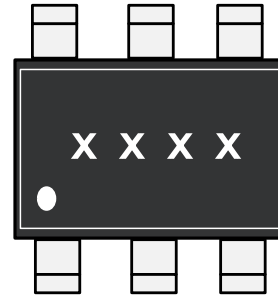
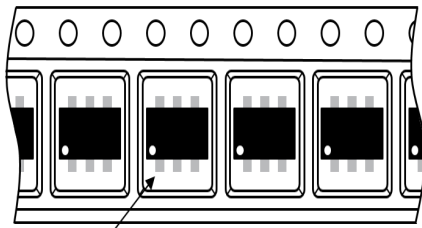

Figure 14. Package orientation in reel



Pin 1 located according to EIA-481

Note: Pocket dimensions are not on scale
Pocket shape may vary depending on package

Figure 15. Tape and reel orientation

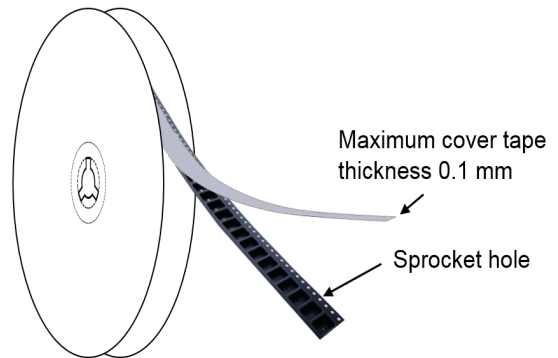

Figure 16. Reel dimensions (mm)

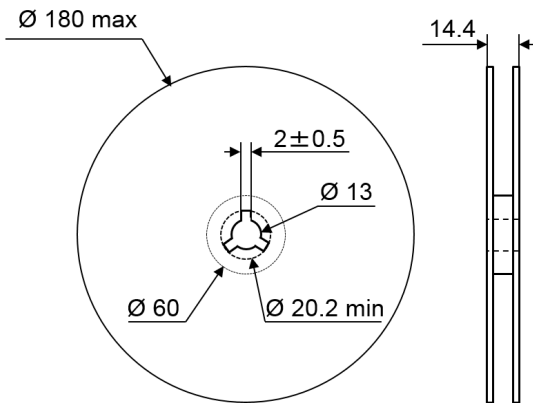

Figure 17. Inner box dimensions (mm)

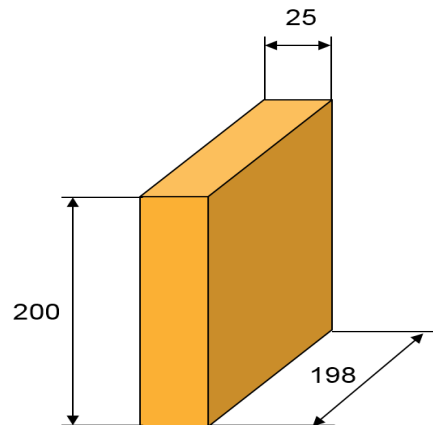
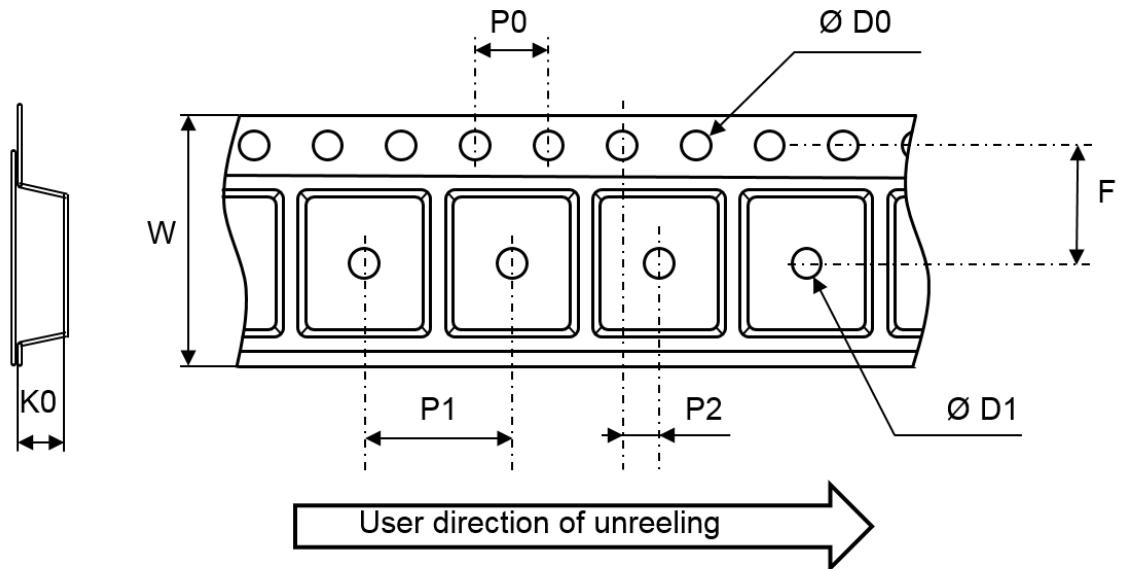

Figure 18. Tape and reel outline

Note: Pocket dimensions are not on scale
 Pocket shape may vary depending on package

Table 4. Tape and reel mechanical data

Ref.	Dimensions		
	Millimeters		
	Min.	Typ.	Max.
P1	3.9	4	4.1
P0	3.9	4	4.1
D0	1.45	1.5	1.6
D1	1		
F	3.45	3.5	3.55
K0	1.3	1.4	1.6
P2	1.95	2	2.05
W	7.9	8	8.3

4 Ordering information

Figure 19. Ordering information scheme

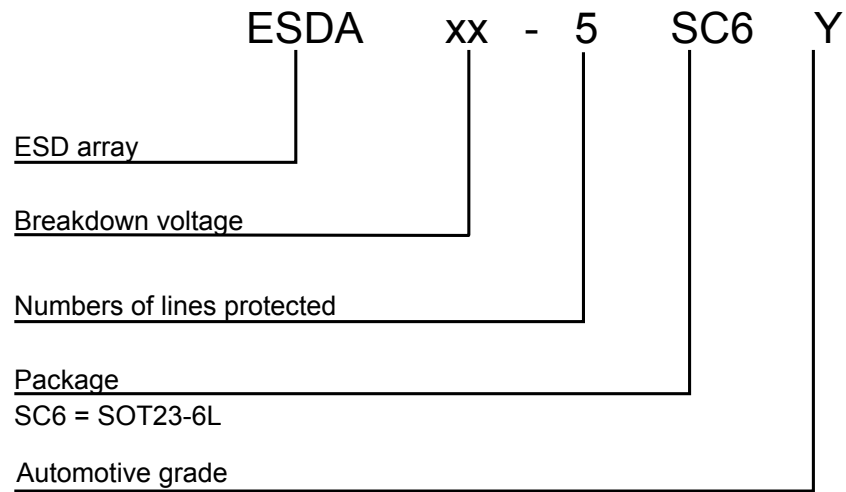

Table 5. Ordering information

Order code	Marking	Package	Weight	Base qty.	Delivery mode
ESDA6V1-5SC6Y	EC6Y	SOT23-6L	14 mg	3000	Tape and reel



Revision history

Table 6. Document revision history

Date	Revision	Changes
08-Nov-2016	1	Initial release.
15-Mar-2017	2	Updated title and description in cover page. Minor text changes to improve readability.
03-May-2017	3	Formatting improvement, no content changes.
08-Jan-2019	4	Updated Table 1 .

**IMPORTANT NOTICE – PLEASE READ CAREFULLY**

STMicroelectronics NV and its subsidiaries (“ST”) reserve the right to make changes, corrections, enhancements, modifications, and improvements to ST products and/or to this document at any time without notice. Purchasers should obtain the latest relevant information on ST products before placing orders. ST products are sold pursuant to ST’s terms and conditions of sale in place at the time of order acknowledgement.

Purchasers are solely responsible for the choice, selection, and use of ST products and ST assumes no liability for application assistance or the design of Purchasers’ products.

No license, express or implied, to any intellectual property right is granted by ST herein.

Resale of ST products with provisions different from the information set forth herein shall void any warranty granted by ST for such product.

ST and the ST logo are trademarks of ST. All other product or service names are the property of their respective owners.

Information in this document supersedes and replaces information previously supplied in any prior versions of this document.

© 2019 STMicroelectronics – All rights reserved

OUR CERTIFICATE

DiGi provide top-quality products and perfect service for customer worldwide through standardization, technological innovation and continuous improvement. DiGi through third-party certification, we stricly control the quality of products and services. Welcome your RFQ to

Email: Info@DiGi-Electronics.com



Tel: +00 852-30501935

RFQ Email: Info@DiGi-Electronics.com

DiGi is a global authorized distributor of electronic components.