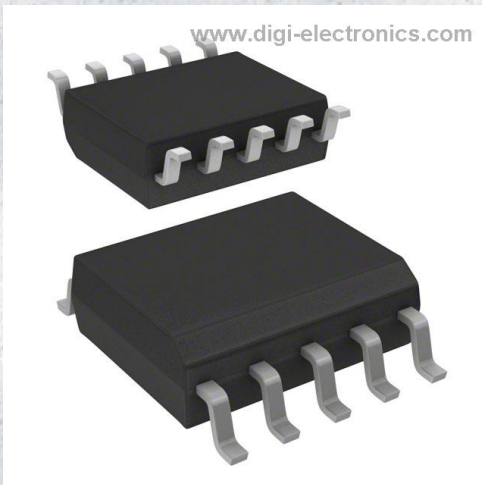


L6564DTR Datasheet



<https://www.DiGi-Electronics.com>

DiGi Electronics Part Number	L6564DTR-DG
Manufacturer	STMicroelectronics
Manufacturer Product Number	L6564DTR
Description	IC PFC CTRLR TRANSITION 10SSOP
Detailed Description	PFC IC Discontinuous (Transition) 10-SSOP

This model L6564DTR is available at DiGi Electronics.

DiGi Electronics offers a global database of semiconductor and electronic component datasheets.

We welcome your inquiries regarding pricing, lead time, or other product-related questions.

 [Request a Quote](#)

 [Datasheet Search](#)



Tel: +00 852-30501935

RFQ Email: Info@DiGi-Electronics.com

DiGi is a global authorized distributor of electronic components.

Purchase and inquiry

Manufacturer Product Number:

L6564DTR

Series:

-

Mode:

Discontinuous (Transition)

Current - Startup:

90 μ A

Operating Temperature:

-25°C ~ 125°C

Package / Case:

10-SOP (0.154", 3.90mm Width)

Base Product Number:

L6564

Manufacturer:

STMicroelectronics

Product Status:

Active

Frequency - Switching:

-

Voltage - Supply:

10.3V ~ 22.5V

Mounting Type:

Surface Mount

Supplier Device Package:

10-SSOP

Environmental & Export classification

RoHS Status:

ROHS3 Compliant

REACH Status:

REACH Unaffected

HTSUS:

8542.39.0001

Moisture Sensitivity Level (MSL):

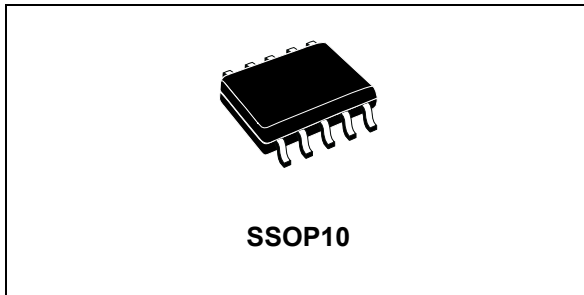
3 (168 Hours)

ECCN:

EAR99

10-pin transition mode PFC controller

Datasheet - production data



- Inductor saturation protection
- AC brownout detection
- Low ($\leq 100 \mu\text{A}$) start-up current
- 6 mA max. operating bias current
- 1% (at $T_J = 25^\circ\text{C}$) internal reference voltage
- -600/+800 mA totem pole gate driver with active pull-down during UVLO
- SSOP10 package

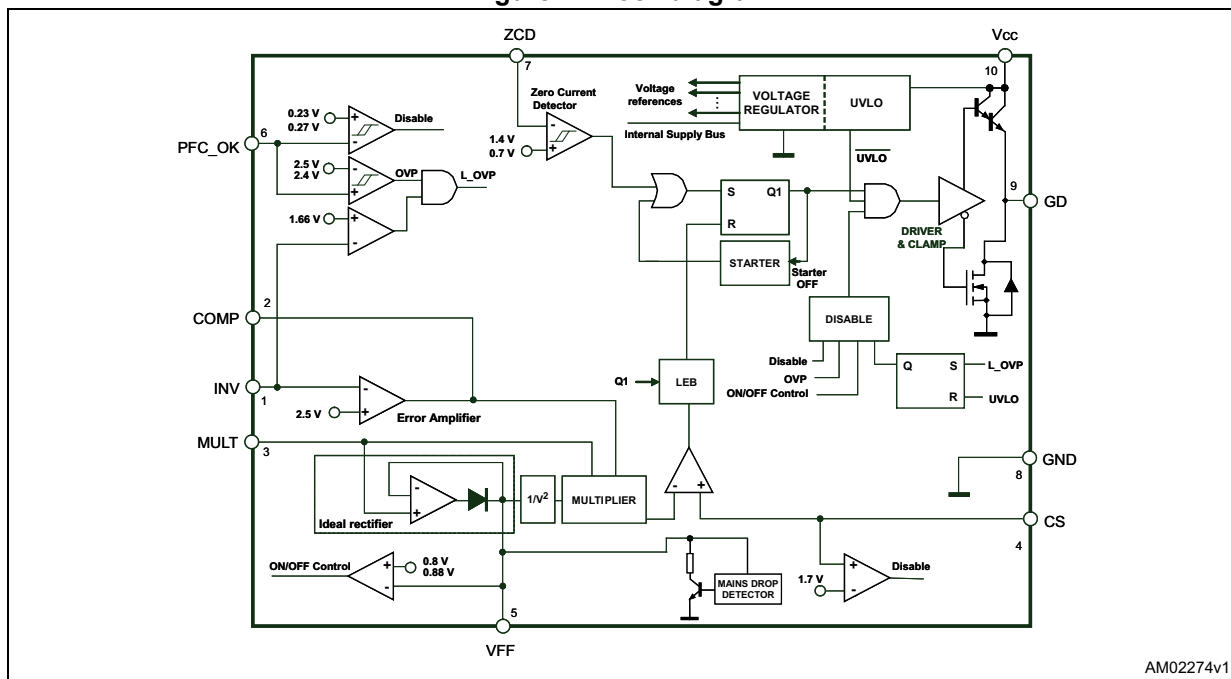
Features

- Fast “bidirectional” input voltage feed-forward ($1/V^2$ correction)
- Accurate adjustable output overvoltage protection
- Protection against feedback loop disconnection (latched shutdown)

Applications

- PFC preregulators for:
 - High-end AC-DC adapter/charger
 - Desktop PC, server, web server
 - IEC61000-3-2 or JEITA-MITI compliant SMPS
- SMPS for LED luminaires

Figure 1. Block diagram



Contents

1	Description	5
2	Maximum ratings	6
	2.1 Absolute maximum ratings	6
	2.2 Thermal data	6
3	Pin connection	7
4	Electrical characteristics	9
5	Typical electrical performance	12
6	Application information	18
	6.1 Overvoltage protection	18
	6.2 Feedback failure protection (FFP)	19
	6.3 Voltage feed-forward	19
	6.4 THD optimizer circuit	22
	6.5 Inductor saturation detection	23
	6.6 Power management/housekeeping functions	25
7	Application examples and ideas	27
8	Package mechanical data	29
9	Order codes	31
10	Revision history	32

List of tables

Table 1.	Absolute maximum ratings	6
Table 2.	Thermal data	6
Table 3.	Pin description	7
Table 4.	Electrical characteristics	9
Table 5.	Summary of L6564 idle states	26
Table 6.	SSOP10 package mechanical data	30
Table 7.	Ordering information	31
Table 8.	Document revision history	32

List of figures

Figure 1.	Block diagram	1
Figure 2.	Pin connection	7
Figure 3.	IC consumption vs. V_{CC}	12
Figure 4.	IC consumption vs. T_J	12
Figure 5.	V_{CC} Zener voltage vs. T_J	12
Figure 6.	Startup and UVLO vs. T_J	12
Figure 7.	Feedback reference vs. T_J	13
Figure 8.	E/A output clamp levels vs. T_J	13
Figure 9.	UVLO saturation vs. T_J	13
Figure 10.	OVP levels vs. T_J	13
Figure 11.	Inductor saturation threshold vs. T_J	14
Figure 12.	Vcs clamp vs. T_J	14
Figure 13.	ZCD sink/source capability vs. T_J	14
Figure 14.	ZCD clamp level vs. T_J	14
Figure 15.	R discharge vs. T_J	15
Figure 16.	Line drop detection threshold vs. T_J	15
Figure 17.	$V_{MULTpk} - V_{VFF}$ dropout vs. T_J	15
Figure 18.	PFC_OK threshold vs. T_J	15
Figure 19.	PFC_OK FFD threshold vs. T_J	15
Figure 20.	Multiplier characteristics at $V_{FF} = 1$ V	16
Figure 21.	Multiplier characteristics at $V_{FF} = 3$ V	16
Figure 22.	Multiplier gain vs. T_J	16
Figure 23.	Gate drive clamp vs. T_J	16
Figure 24.	Gate drive output saturation vs. T_J	17
Figure 25.	Delay to output vs. T_J	17
Figure 26.	Start-up timer period vs. T_J	17
Figure 27.	Output voltage setting, OVP and FFP functions: internal block diagram	18
Figure 28.	Voltage feed-forward: squarer-divider ($1/V^2$) block diagram and transfer characteristic	20
Figure 29.	$R_{FF} \cdot C_{FF}$ as a function of 3 rd harmonic distortion introduced in the input current	21
Figure 30.	THD optimizer circuit	22
Figure 31.	THD optimization: standard TM PFC controller (left side) and L6564 (right side)	23
Figure 32.	Effect of boost inductor saturation on the MOSFET current and detection method	24
Figure 33.	Interface circuits that let dc-dc converter's controller IC disable the L6564	25
Figure 34.	Demonstration board EVL6564-100W, wide-range mains: electrical schematic	27
Figure 35.	L6564 100W TM PFC: compliance to EN61000-3-2 standard	28
Figure 36.	L6564 100W TM PFC: compliance to JEITA-MITI standard	28
Figure 37.	L6564 100 W TM PFC: input current waveform at 230 - 50 Hz - 100 W load	28
Figure 38.	L6564 100W TM PFC: input current waveform at 100 V - 50 Hz - 100 W load	28
Figure 39.	SSOP10 package outline	29

1 Description

The L6564 device is a current mode PFC controller operating in transition mode (TM) and represents the compact version of the L6563S device as it embeds the same driver, reference and control stages in a very compact 10-pin SSOP10 package.

The highly linear multiplier, along with a special correction circuit that reduces crossover distortion of the mains current, allows wide range mains operation with an extremely low THD even over a large load range.

The output voltage is controlled by means of a voltage mode error amplifier and an accurate (1% at $T_J = 25\text{ }^\circ\text{C}$) internal voltage reference. The loop stability is optimized by the voltage feed-forward function ($1/V^2$ correction), which in this IC uses a proprietary technique that considerably improves line transient response as well in case of mains both drops and surges ("bidirectional").

In addition to overvoltage protection able to control the output voltage during transient conditions, the IC also provides protection against feedback loop failures or erroneous settings. Other on-board protection functions allow brownout conditions and boost inductor saturation to be safely handled.

The totem-pole output stage, capable of 600 mA source and 800 mA sink current, is suitable for the high power MOSFET or IGBT drive. This, combined with the other features and the possibility to operate with ST's proprietary fixed-off-time control, makes the device an excellent solution for SMPS up to 400 W that require compliance with the EN61000-3-2 and JEITA-MITI standards.

2 Maximum ratings

2.1 Absolute maximum ratings

Table 1. Absolute maximum ratings

Symbol	Pin	Parameter	Value	Unit
V_{CC}	10	IC supply voltage ($I_{CC} \leq 20$ mA)	Self-limited	V
---	1, 3, 6	Max. pin voltage ($I_{pin} \leq 1$ mA)	Self-limited	V
---	2, 4, 5	Analog inputs and outputs	-0.3 to 8	V
I_{ZCD}	7	Zero current detector max. current	-10 (source) 10 (sink)	mA
V_{FF} pin	5	Maximum withstanding voltage range test condition: CDF-AEC-Q100-002 "human body model" Acceptance criteria: "normal performance"	+/- 1750	V
Other pins	1 to 4 6 to 10		+/- 2000	V

2.2 Thermal data

Table 2. Thermal data

Symbol	Parameter	Value	Unit
R_{thJA}	Max. thermal resistance, junction-to-ambient	120	°C/W
P_{tot}	Power dissipation at $T_A = 50$ °C	0.75	W
T_J	Junction temperature operating range	-40 to 150	°C
T_{stg}	Storage temperature	-55 to 150	°C

3 Pin connection

Figure 2. Pin connection

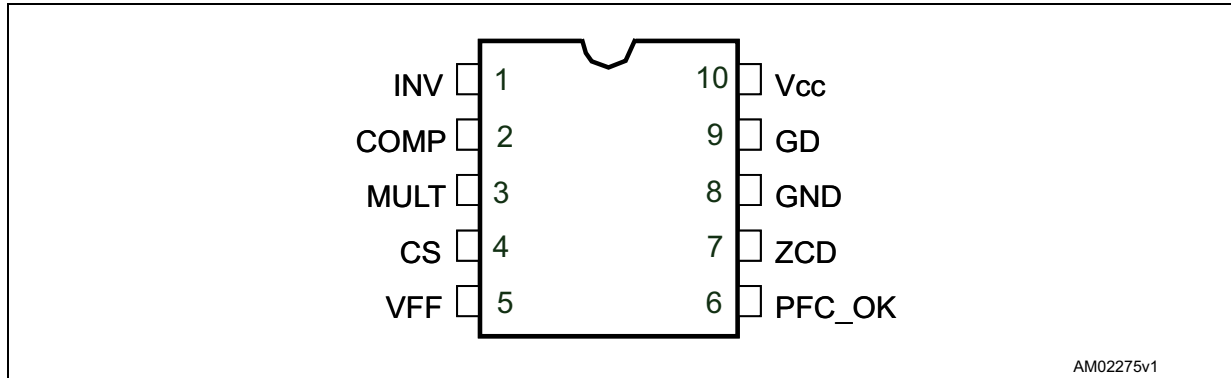


Table 3. Pin description

N°	Name	Function
1	INV	Inverting input of the error amplifier. The information on the output voltage of the PFC preregulator is fed into the pin through a resistor divider. The pin normally features high impedance.
2	COMP	Output of the error amplifier. A compensation network is placed between this pin and INV (pin 1) to achieve stability of the voltage control loop and ensure high power factor and low THD. To avoid uncontrolled rise of the output voltage at zero load, when the voltage on the pin falls below 2.4 V the gate driver output will be inhibited (burst-mode operation).
3	MULT	Main input to the multiplier. This pin is connected to the rectified mains voltage via a resistor divider and provides the sinusoidal reference to the current loop. The voltage on this pin is used also to derive the information on the RMS mains voltage.
4	CS	Input to the PWM comparator. The current flowing in the MOSFET is sensed through a resistor, the resulting voltage is applied to this pin and compared with an internal reference to determine MOSFET's turn-off. A second comparison level at 1.7 V detects abnormal currents (e.g. due to boost inductor saturation) and, on this occurrence, activates a safety procedure that temporarily stops the converter and limits the stress of the power components.
5	V _{FF}	Second input to the multiplier for $1/V^2$ function. A capacitor and a parallel resistor must be connected from the pin to GND. They complete the internal peak-holding circuit that derives the information on the RMS mains voltage. The voltage at this pin, a dc level equal to the peak voltage on pin MULT (3), compensates the control loop gain dependence on the mains voltage. Never connect the pin directly to GND but with a resistor ranging from 100 K Ω (minimum) to 2 M Ω (maximum). This pin is internally connected to a comparator in order to provide the brownout (AC mains undervoltage) protection. A voltage below 0.8 V shuts down (not latched) the IC and brings its consumption to a considerably lower level. The IC restarts as the voltage at the pin goes above 0.88 V.

Table 3. Pin description (continued)

N°	Name	Function
6	PFC_OK	<p>PFC preregulator output voltage monitoring/disable function. This pin senses the output voltage of the PFC preregulator through a resistor divider and is used for protection purposes.</p> <p>If the voltage on the pin exceeds 2.5 V the IC stops switching and restarts as the voltage on the pin falls below 2.4 V. However, if at the same time the voltage of the INV pin falls below 1.66 V, a feedback failure is assumed. In this case the device is latched off. Normal operation can be resumed only by cycling V_{CC}, bringing its value lower than 6 V before to move up to Turn-on threshold.</p> <p>If the voltage on this pin is brought below 0.23 V the IC is shut down. To restart the IC the voltage on the pin must go above 0.27 V. This can be used as a remote on/off control input.</p>
7	ZCD	Boost inductor's demagnetization sensing input for transition mode operation. A negative-going edge triggers MOSFET's turn-on.
8	GND	Ground. Current return for both the signal part of the IC and the gate driver.
9	GD	Gate driver output. The totem pole output stage is able to drive the Power MOSFET's and IGBT's with a peak current of 600 mA source and 800 mA sink. The high-level voltage of this pin is clamped at about 12 V to avoid excessive gate voltages.
10	V_{CC}	Supply Voltage of both the signal part of the IC and the gate driver. Sometimes a small bypass capacitor (0.1 μ F typ.) to GND might be useful to get a clean bias voltage for the signal part of the IC.

4 Electrical characteristics

$T_J = -25$ to 125 °C, $V_{CC} = 12$ V, $C_O = 1$ nF between the pin GD and GND, $C_{FF} = 1$ μ F and $R_{FF} = 1$ M Ω between the pin V_{FF} and GND; unless otherwise specified.

Table 4. Electrical characteristics

Symbol	Parameter	Test condition	Min.	Typ.	Max.	Unit
Supply voltage						
V_{CC}	Operating range	After turn-on	10.3		22.5	V
V_{CCOn}	Turn-on threshold	(1)	11	12	13	V
V_{CCOff}	Turn-off threshold	(1)	8.7	9.5	10.3	V
$V_{CCrestart}$	V_{CC} for resuming from latch	OVP latched	5	6	7	V
Hys	Hysteresis		2.3		2.7	V
V_Z	Zener voltage	$I_{CC} = 20$ mA	22.5	25	28	V
Supply current						
$I_{start-up}$	Start-up current	Before turn-on, $V_{CC} = 10$ V		90	150	μ A
I_q	Quiescent current	After turn-on, $V_{MULT} = 1$ V		4	5	mA
I_{CC}	Operating supply current	At 70 kHz		5	6.0	mA
I_{qdis}	Idle state quiescent current	$V_{PFC_OK} > V_{PFC_OK_S}$ AND $V_{INV} < V_{FFD}$		180	280	μ A
		$V_{PFC_OK} < V_{PFC_OK_D}$		1.5	2.2	mA
I_q	Quiescent current	$V_{PFC_OK} > V_{PFC_OK_S}$ OR $V_{COMP} < 2.3$ V		2.2	3	mA
Multiplier input						
I_{MULT}	Input bias current	$V_{MULT} = 0$ to 3 V		-0.2	-1	μ A
V_{MULT}	Linear operation range		0 to 3			V
V_{CLAMP}	Internal clamp level	$I_{MULT} = 1$ mA	9	9.5		V
ΔV_{CS} ΔV_{MULT}	Output max. slope	$V_{MULT} = 0$ to 0.4 V, $V_{VFF} = 1$ V $V_{COMP} =$ upper clamp	1.33	1.66		V/V
K_M	Gain ⁽²⁾	$V_{MULT} = 1$ V, $V_{COMP} = 4$ V	0.375	0.45	0.525	1/V
Error amplifier						
V_{INV}	Voltage feedback input threshold	$T_J = 25$ °C	2.475	2.5	2.525	V
		10.3 V $< V_{CC} < 22.5$ V ⁽³⁾	2.455		2.545	
	Line regulation	$V_{CC} = 10.3$ V to 22.5 V		2	5	mV
I_{INV}	Input bias current	$V_{INV} = 0$ to 4 V		-0.2	-1	μ A
$V_{INVCLAMP}$	Internal clamp level	$I_{INV} = 1$ mA	8	9		V
Gv	Voltage gain	Open loop	60	80		dB
GB	Gain-bandwidth product			1		MHz

Electrical characteristics

L6564

Table 4. Electrical characteristics (continued)

Symbol	Parameter	Test condition	Min.	Typ.	Max.	Unit
I_{COMP}	Source current	$V_{COMP} = 4\text{ V}$, $V_{INV} = 2.4\text{ V}$	2	4		mA
	Sink current	$V_{COMP} = 4\text{ V}$, $V_{INV} = 2.6\text{ V}$	2.5	4.5		mA
V_{COMP}	Upper clamp voltage	$I_{SOURCE} = 0.5\text{ mA}$	5.7	6.2	6.7	V
	Burst-mode voltage	(3)	2.3	2.4	2.5	
	Lower clamp voltage	$I_{SINK} = 0.5\text{ mA}^{(3)}$	2.1	2.25	2.4	
Boost inductor saturation detector						
V_{CS_th}	Threshold on current sense	(3)	1.6	1.7	1.8	V
I_{INV}	E/A input pull-up current	After $V_{CS} > V_{CS_th}$, before restarting	5	10	13	μA
Start-up timer						
t_{START_DEL}	Start-up delay	First cycle after wakeup	25	50	75	μs
t_{START}	Timer period		75	150	300	μs
		Restart after $V_{CS} > V_{CS_th}$	150	300	600	
Current sense comparator						
I_{CS}	Input bias current	$V_{CS} = 0$			1	μA
t_{LEB}	Leading edge blanking		100	150	250	ns
$t_{d(H-L)}$	Delay to output		100	200	300	ns
$V_{CSclamp}$	Current sense reference clamp	$V_{COMP} = \text{upper clamp}$, $V_{MULT} = 1\text{ V}$, $V_{VFF} = 1\text{ V}$	1.0	1.08	1.16	V
V_{CSofst}	Current sense offset	$V_{MULT} = 0$, $V_{VFF} = 3\text{ V}$		40	70	mV
		$V_{MULT} = 3\text{ V}$, $V_{VFF} = 3\text{ V}$		20		
PFC_OK functions						
I_{PFC_OK}	Input bias current	$V_{PFC_OK} = 0\text{ to }2.6\text{ V}$		-0.1	-1	μA
$V_{PFC_OK_C}$	Clamp voltage	$I_{PFC_OK} = 1\text{ mA}$	9	9.5		V
$V_{PFC_OK_S}$	OVP threshold	(1) voltage rising	2.435	2.5	2.565	V
$V_{PFC_OK_R}$	Restart threshold after OVP	(1) voltage falling	2.34	2.4	2.46	V
$V_{PFC_OK_D}$	Disable threshold	(1) voltage falling	0.12		0.35	V
$V_{PFC_OK_D}$	Disable threshold	(1) voltage falling $T_J = 25\text{ }^\circ\text{C}$	0.17	0.23	0.29	V
$V_{PFC_OK_E}$	Enable threshold	(1) voltage rising	0.15		0.38	V
$V_{PFC_OK_E}$	Enable threshold	(1) voltage rising $T_J = 25\text{ }^\circ\text{C}$	0.21	0.27	0.32	V
V_{FFD}	Feedback failure detection threshold (V_{INV} falling)	$V_{PFC_OK} = V_{PFC_OK_S}$	1.61	1.66	1.71	V

Table 4. Electrical characteristics (continued)

Symbol	Parameter	Test condition	Min.	Typ.	Max.	Unit
Voltage feed-forward						
V _{VFF}	Linear operation range		1		3	V
ΔV	Dropout V _{MULTpk} -V _{VFF}	V _{CC} < V _{CCOn}			800	mV
		V _{CC} > or = to V _{CCOn}			20	
ΔV _{VFF}	Line drop detection thresh.	Below peak value	40	70	100	mV
ΔV _{VFF}	Line drop detection thresh.	Below peak value T _J = 25 °C	50	70	90	mV
R _{DISCH}	Internal discharge resistor	T _J = 25 °C	7.5	10	12.5	kΩ
			5		20	
V _{DIS}	Disable threshold	(2) voltage falling	0.745	0.8	0.855	V
V _{EN}	Enable threshold	(2) voltage rising	0.845	0.88	0.915	V
Zero current detector						
V _{ZCDH}	Upper clamp voltage	I _{ZCD} = 2.5 mA	5.0	5.7		V
V _{ZCDL}	Lower clamp voltage	I _{ZCD} = - 2.5 mA	-0.3	0	0.3	V
V _{ZCDA}	Arming voltage (positive-going edge)		1.1	1.4	1.9	V
V _{ZCDT}	Triggering voltage (negative-going edge)		0.5	0.7	0.9	V
I _{ZCDB}	Input bias current	V _{ZCD} = 1 to 4.5 V			1	μA
I _{ZCDsrc}	Source current capability		-2.5	-4		mA
I _{ZCDsnk}	Sink current capability		2.5	5		mA
Gate driver						
V _{OL}	Output low voltage	I _{sink} = 100 mA		0.6	1.2	V
V _{OH}	Output high voltage	I _{source} = 5 mA	9.8	10.3		V
I _{srpk}	Peak source current		-0.6			A
I _{snkpk}	Peak sink current		0.8			A
t _f	Voltage fall time			30	60	ns
t _r	Voltage rise time			45	110	ns
V _{Oclamp}	Output clamp voltage	I _{source} = 5 mA; V _{CC} = 20 V	10	12	15	V
	UVLO saturation	V _{CC} = 0 to V _{CCOn} , I _{sink} = 2 mA			1.1	V

1. Parameters tracking each other

2. The multiplier output is given by: $V_{CS} = V_{CS_Ofst} + K_M \cdot \frac{V_{MULT} \cdot (V_{COMP} - 2.5)}{V_{VFF}^2}$

3. Parameters tracking each other

5 Typical electrical performance

Figure 3. IC consumption vs. V_{CC}

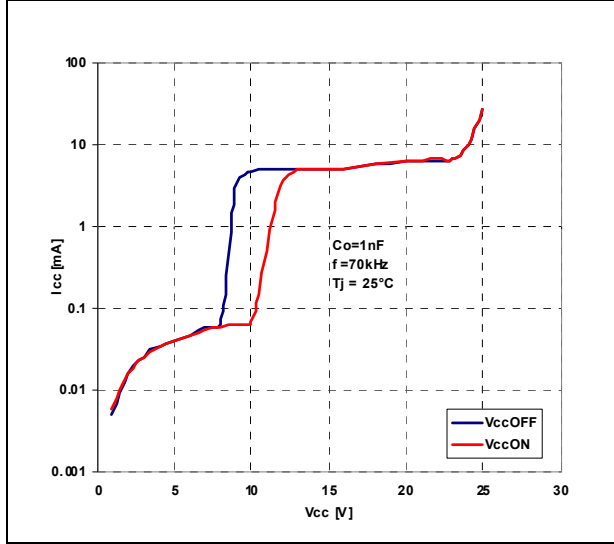


Figure 4. IC consumption vs. T_J

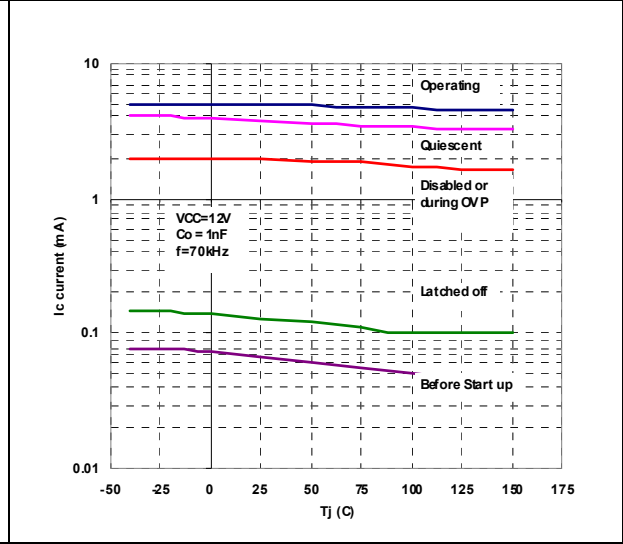


Figure 5. V_{CC} Zener voltage vs. T_J

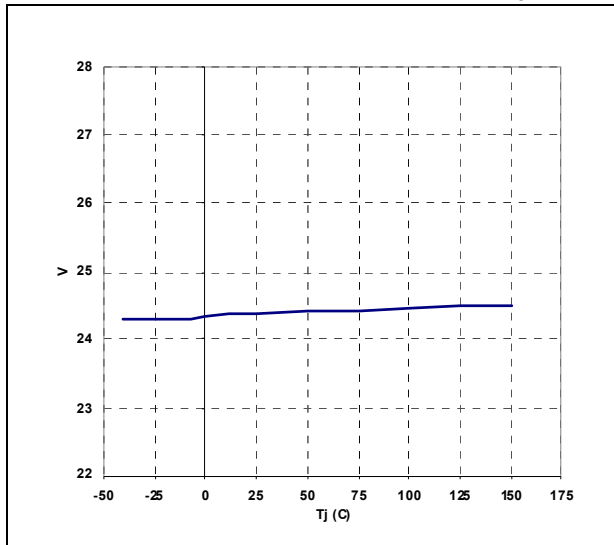


Figure 6. Startup and UVLO vs. T_J

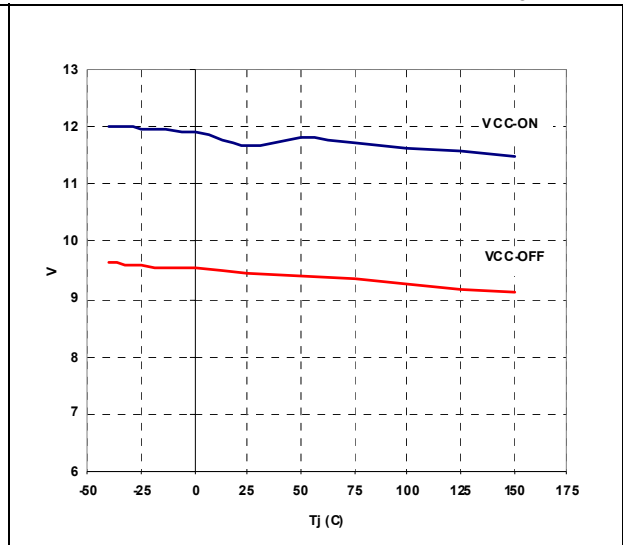


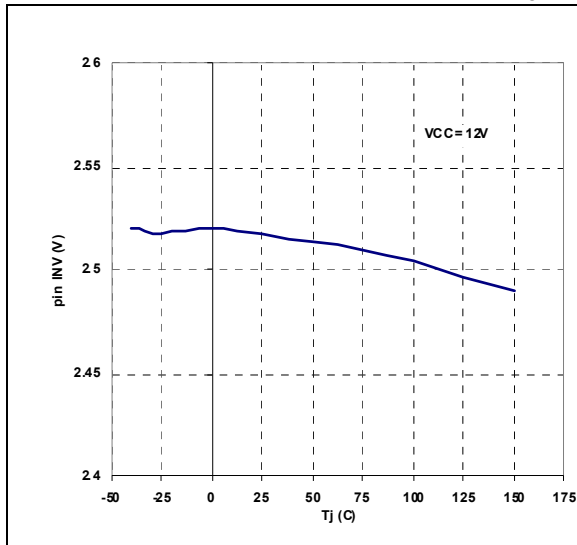
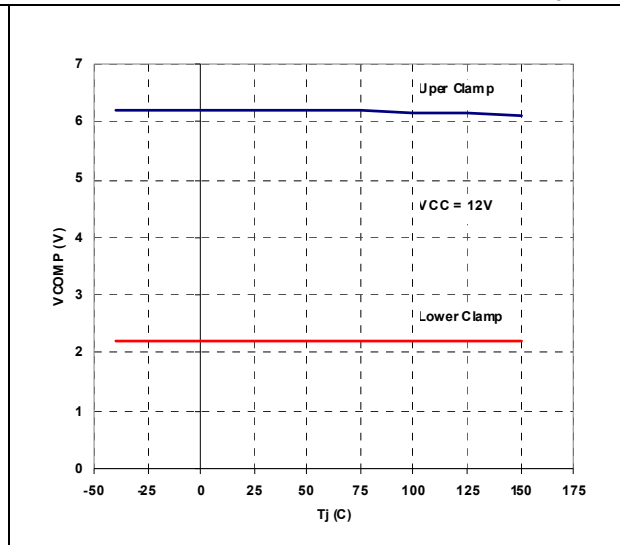
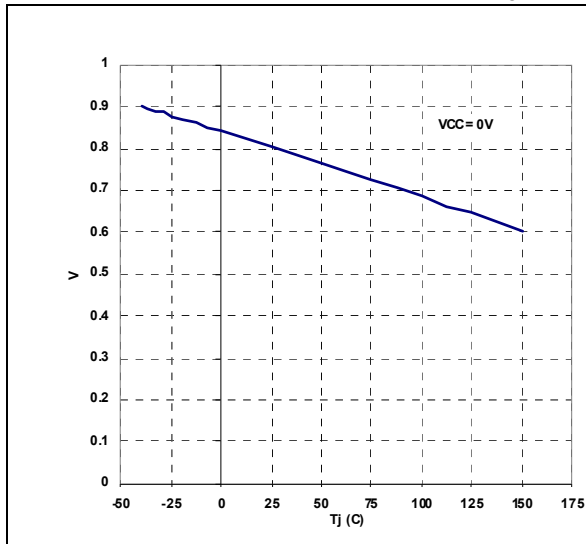
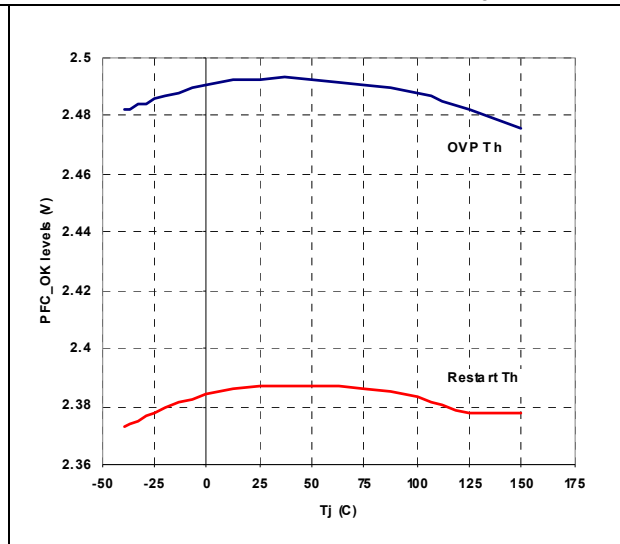
Figure 7. Feedback reference vs. T_J Figure 8. E/A output clamp levels vs. T_J Figure 9. UVLO saturation vs. T_J Figure 10. OVP levels vs. T_J 

Figure 11. Inductor saturation threshold vs. T_J

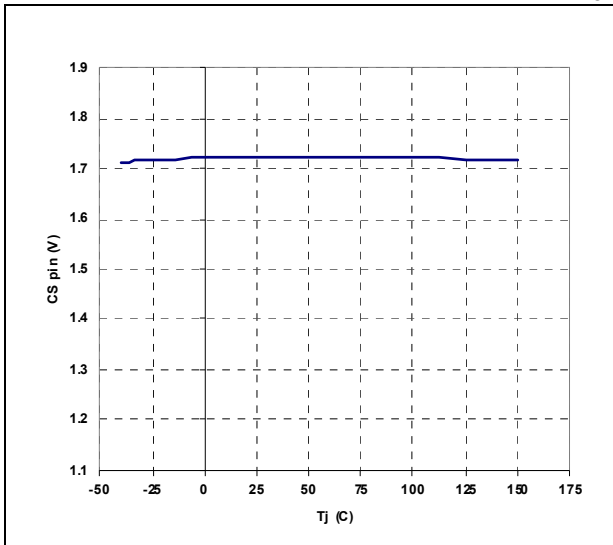


Figure 12. V_{CS} clamp vs. T_J

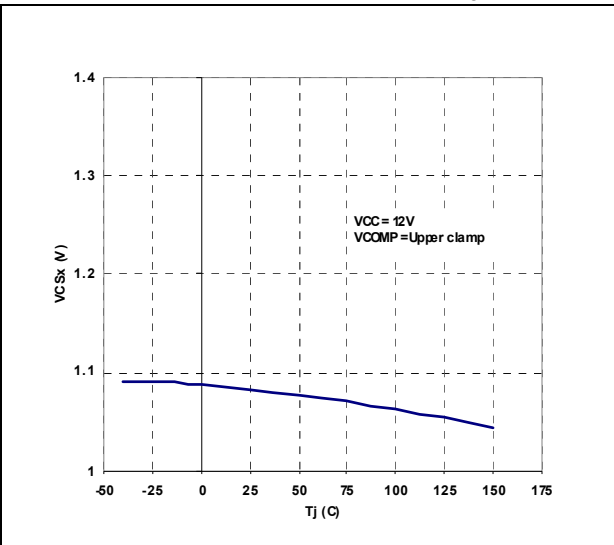


Figure 13. ZCD sink/source capability vs. T_J

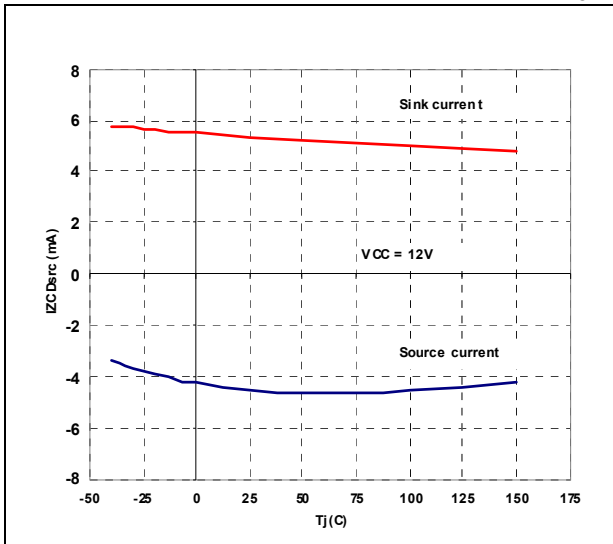


Figure 14. ZCD clamp level vs. T_J

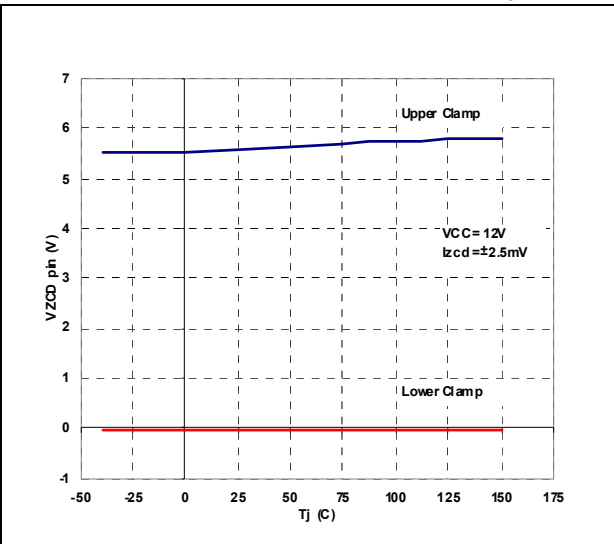


Figure 15. R discharge vs. T_J

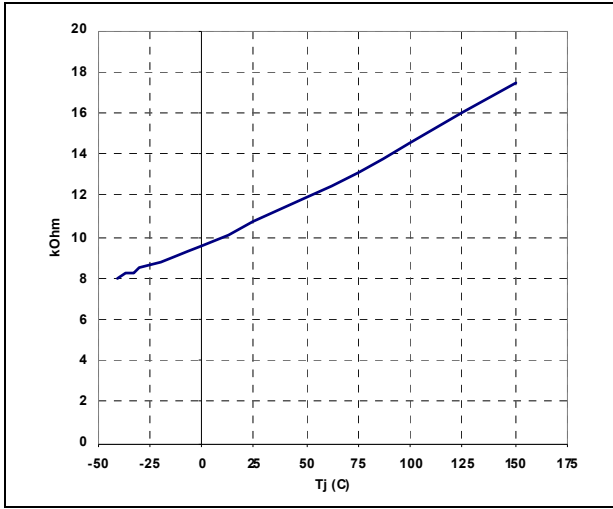


Figure 16. Line drop detection threshold vs. T_J

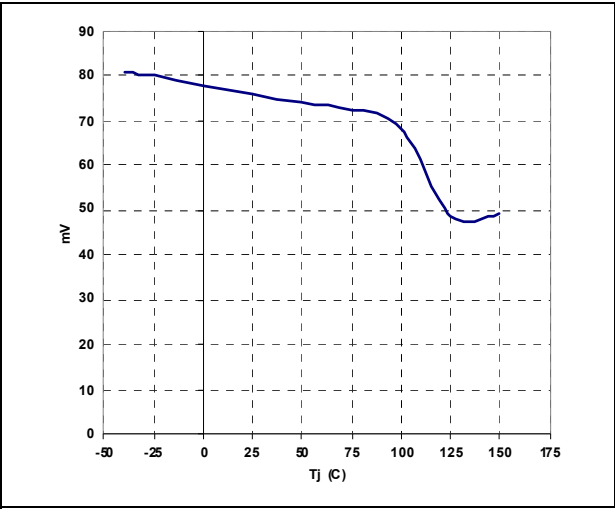


Figure 17. $V_{MULTpk} - V_{VFF}$ dropout vs. T_J

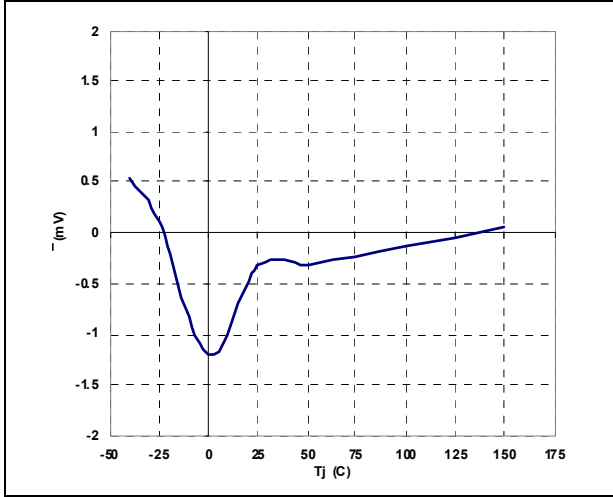


Figure 18. PFC_OK threshold vs. T_J

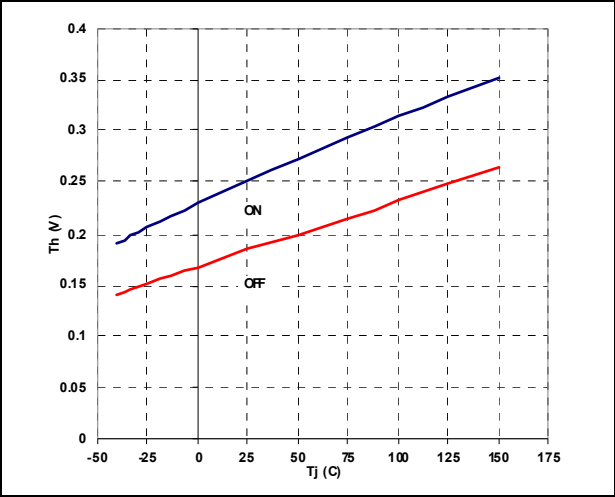


Figure 19. PFC_OK FFD threshold vs. T_J

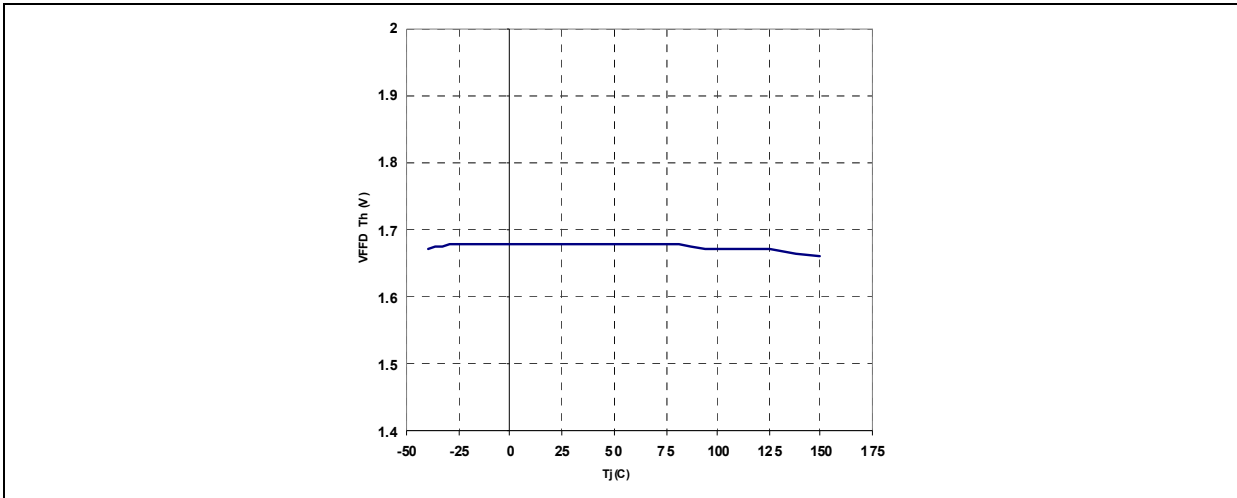


Figure 20. Multiplier characteristics at $V_{FF} = 1\text{ V}$ Figure 21. Multiplier characteristics at $V_{FF} = 3\text{ V}$

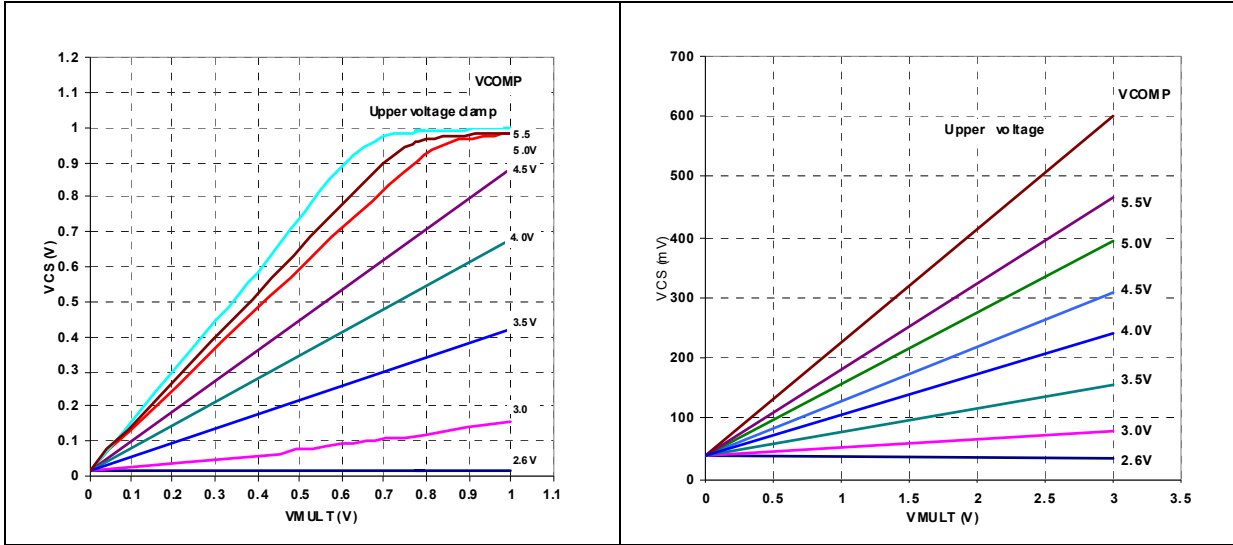


Figure 22. Multiplier gain vs. T_J

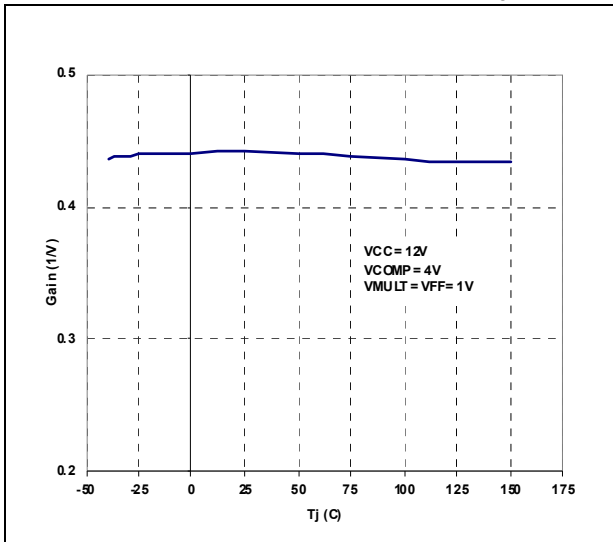


Figure 23. Gate drive clamp vs. T_J

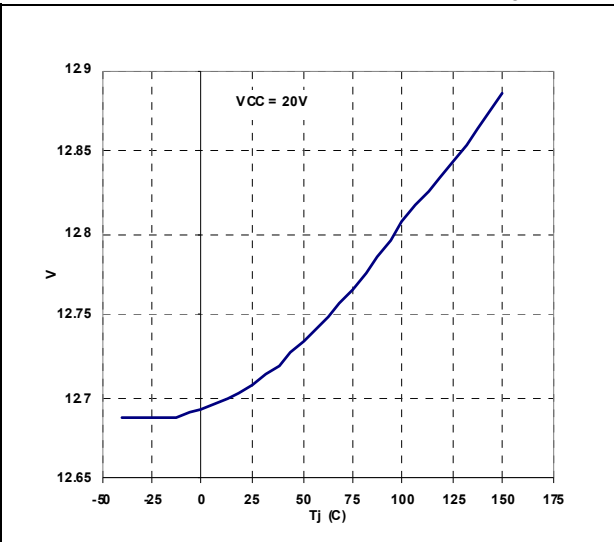
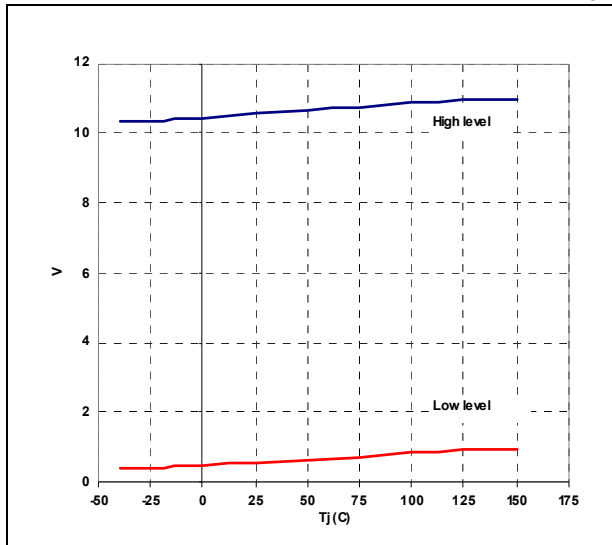
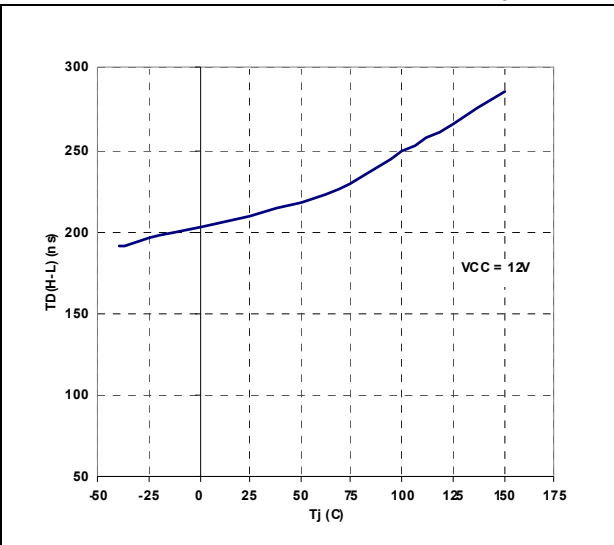
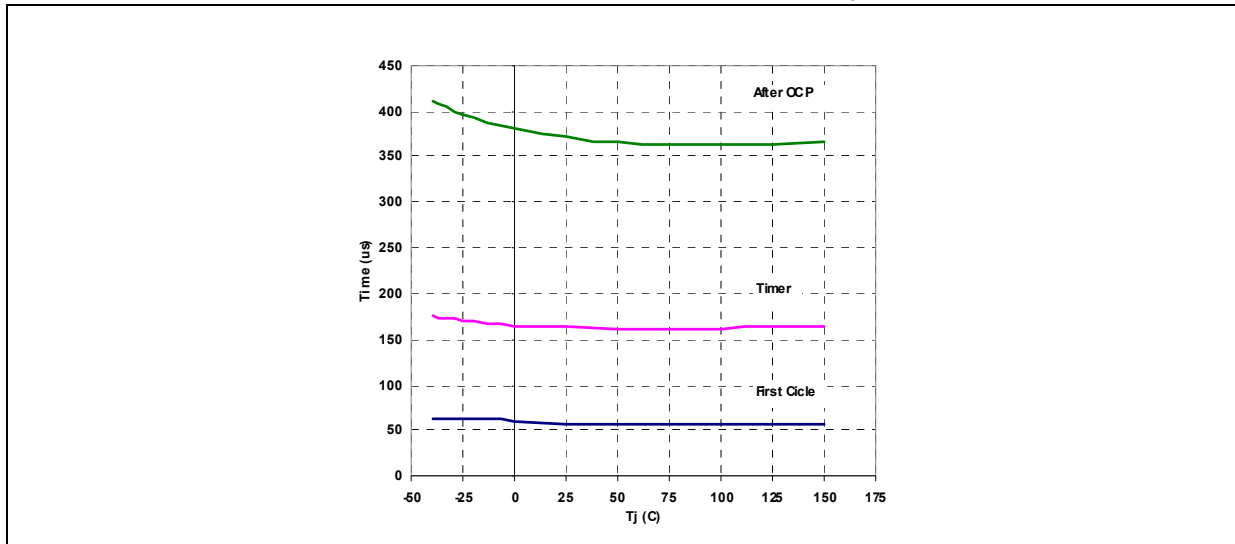


Figure 24. Gate drive output saturation vs. T_J Figure 25. Delay to output vs. T_J Figure 26. Start-up timer period vs. T_J 

6.2 Feedback failure protection (FFP)

The OVP function described above handles “normal” overvoltage conditions, i.e. those resulting from an abrupt load/line change or occurring at startup. In case the overvoltage is generated by a feedback disconnection, for instance when the upper resistor of the output divider (R1) fails open, the comparator detects the voltage at the INV pin. If the voltage is lower than 1.66 V and the OVP is active, the FFP is triggered, the gate drive activity is immediately stopped, the device is shut down, its quiescent consumption is reduced below 180 μ A and the condition is latched as long as the supply voltage of the IC is above the UVLO threshold. To restart the system it is necessary to recycle the input power, so that the V_{CC} voltage of the L6564 device goes below 6 V.

The PFC_OK pin doubles its function as a not-latched IC disable: a voltage below 0.23 V will shut down the IC, reducing its consumption below 2 mA. To restart the IC simply let the voltage at the pin go above 0.27 V.

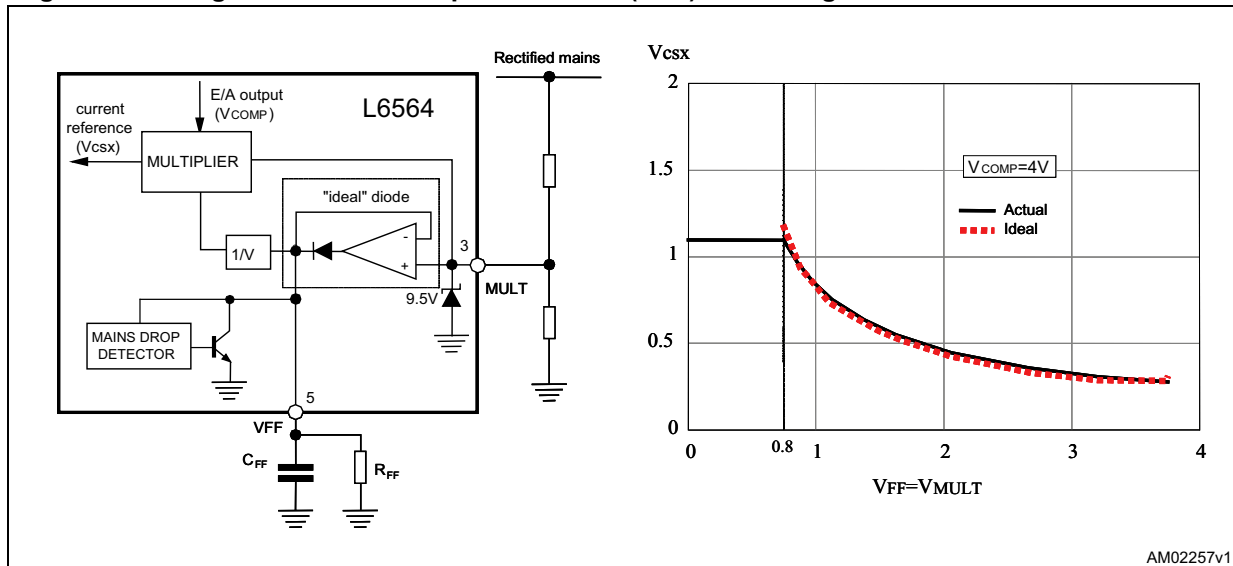
Note that these functions offer complete protection against not only feedback loop failures or erroneous settings, but also against a failure of the protection itself. Either the resistor of the PFC_OK divider failing short or open or a PFC_OK pin floating will result in shutting down the IC and stopping the preregulator.

6.3 Voltage feed-forward

The power stage gain of PFC preregulators varies with the square of the RMS input voltage. So does the crossover frequency f_c of the overall open-loop gain because the gain has a single pole characteristic. This leads to large trade-off in the design.

For example, setting the gain of the error amplifier to get $f_c = 20$ Hz at 264 Vac means having $f_c = 4$ Hz at 88 Vac, resulting in a sluggish control dynamics. Additionally, the slow control loop causes large transient current flow during rapid line or load changes that are limited by the dynamics of the multiplier output. This limit is considered when selecting the sense resistor to let the full load power pass under minimum line voltage conditions, with some margin. But a fixed current limit allows excessive power input at high line, whereas a fixed power limit requires the current limit to vary inversely with the line voltage.

Voltage feed-forward can compensate for the gain variation with the line voltage and allow minimizing all of the above-mentioned issues. It consists of deriving a voltage proportional to the input RMS voltage, feeding this voltage into a squarer/divider circuit ($1/V^2$ corrector) and providing the resulting signal to the multiplier that generates the current reference for the inner current control loop (see [Figure 28](#)).

Figure 28. Voltage feed-forward: squarer-divider ($1/V^2$) block diagram and transfer characteristic

In this way a change of the line voltage will cause an inversely proportional change of the half sine amplitude at the output of the multiplier (if the line voltage doubles the amplitude of the multiplier output will be halved and vice versa) so that the current reference is adapted to the new operating conditions with (ideally) no need for invoking the slow dynamics of the error amplifier. Additionally, the loop gain will be constant throughout the input voltage range, which improves significantly dynamic behavior at low line and simplifies loop design.

Actually, deriving a voltage proportional to the RMS line voltage implies a form of integration, which has its own time constant. If it is too small the voltage generated will be affected by a considerable amount of ripple at twice the mains frequency that will cause distortion of the current reference (resulting in high THD and poor PF); if it is too large there will be a considerable delay in setting the right amount of feed-forward, resulting in excessive overshoot and undershoot of the preregulator's output voltage in response to large line voltage changes. Clearly a trade-off was required.

The L6564 device realizes a NEW voltage feed forward that, with a technique that makes use of just two external parts, strongly minimizes this time constant trade-off issue whichever voltage change occurs on the mains, both surges and drops. A capacitor C_{FF} and a resistor R_{FF}, both connected from the pin V_{FF} (#5) to ground, complete an internal peak-holding circuit that provides a DC voltage equal to the peak of the rectified sine wave applied on pin MULT (#3). In this way, in case of sudden line voltage rise, C_{FF} will be rapidly charged through the low impedance of the internal diode; in case of line voltage drop, an internal "mains drop" detector enables a low impedance switch which suddenly discharges C_{FF} avoiding long settling time before reaching the new voltage level. The discharge of C_{FF} is stopped as its voltage equals the voltage on the pin MULT or if the voltage on the pin V_{FF} falls below 0.88 V, to prevent the "Brownout protection" function from being improperly activated (see [Section 6.6: Power management/housekeeping functions on page 25](#)).

As a result of the V_{FF} pin functionality, an acceptably low steady-state ripple and low current distortion can be achieved with a limited undershoot or overshoot on the preregulator's output.

The twice-mains-frequency ($2 \cdot f_L$) ripple appearing across C_{FF} is triangular with a peak-to-peak amplitude that, with good approximation, is given by:

Equation 1

$$\Delta V_{FF} = \frac{2V_{MULTpk}}{1 + 4f_L R_{FF} C_{FF}}$$

where f_L is the line frequency. The amount of 3rd harmonic distortion introduced by this ripple, related to the amplitude of its $2 \cdot f_L$ component, will be:

Equation 2

$$D_3 \% = \frac{100}{2\pi f_L R_{FF} C_{FF}}$$

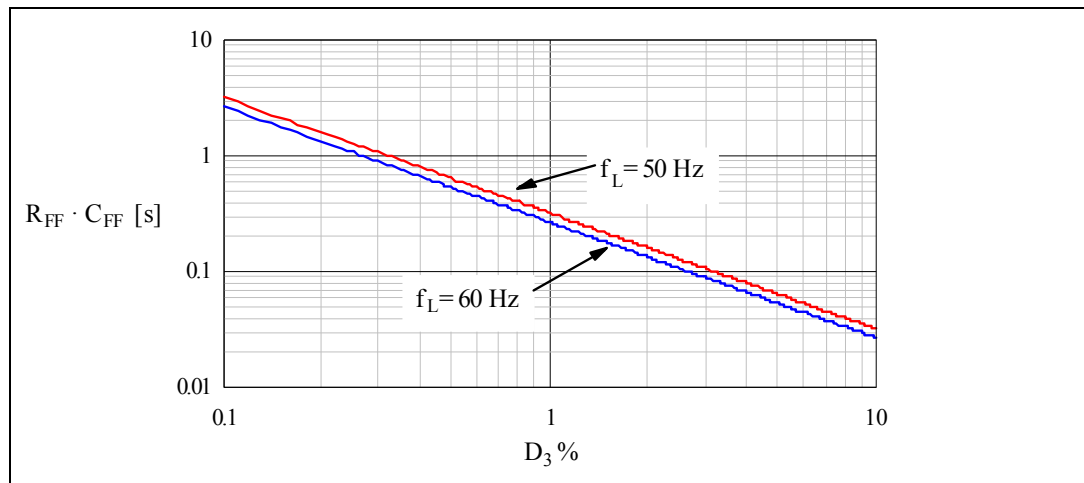
Figure 29 shows a diagram that helps choose the time constant $R_{FF} \cdot C_{FF}$ based on the amount of maximum desired 3rd harmonic distortion. Note that there is a minimum value for the time constant $R_{FF} \cdot C_{FF}$ below which improper activation of the V_{FF} fast discharge may occur. In fact, the twice-mains-frequency ripple across C_{FF} under steady state conditions must be lower than the minimum line drop detection threshold ($\Delta V_{FF_min} = 40$ mV). Therefore:

Equation 3

$$R_{FF} \cdot C_{FF} > \frac{2 \frac{V_{MULTpk_max}}{\Delta V_{FF_min}} - 1}{4 f_{L_min}}$$

Always connect RFF and CFF to the pin, the IC will not work properly if the pin is either left floating or connected directly to ground.

Figure 29. $R_{FF} \cdot C_{FF}$ as a function of 3rd harmonic distortion introduced in the input current



6.4 THD optimizer circuit

The L6564 device is provided with a special circuit that reduces the conduction dead-angle occurring to the AC input current near the zero-crossings of the line voltage (crossover distortion). In this way the THD (total harmonic distortion) of the current is considerably reduced.

A major cause of this distortion is the inability of the system to transfer energy effectively when the instantaneous line voltage is very low. This effect is magnified by the high-frequency filter capacitor placed after the bridge rectifier, which retains some residual voltage that causes the diodes of the bridge rectifier to be reverse-biased and the input current flow to temporarily stop.

To overcome this issue the device forces the PFC preregulator to process more energy near the line voltage zero-crossings as compared to that commanded by the control loop. This will result in both minimizing the time interval where energy transfer is lacking and fully discharging the high-frequency filter capacitor after the bridge.

Figure 30 shows the internal block diagram of the THD optimizer circuit.

Figure 30. THD optimizer circuit

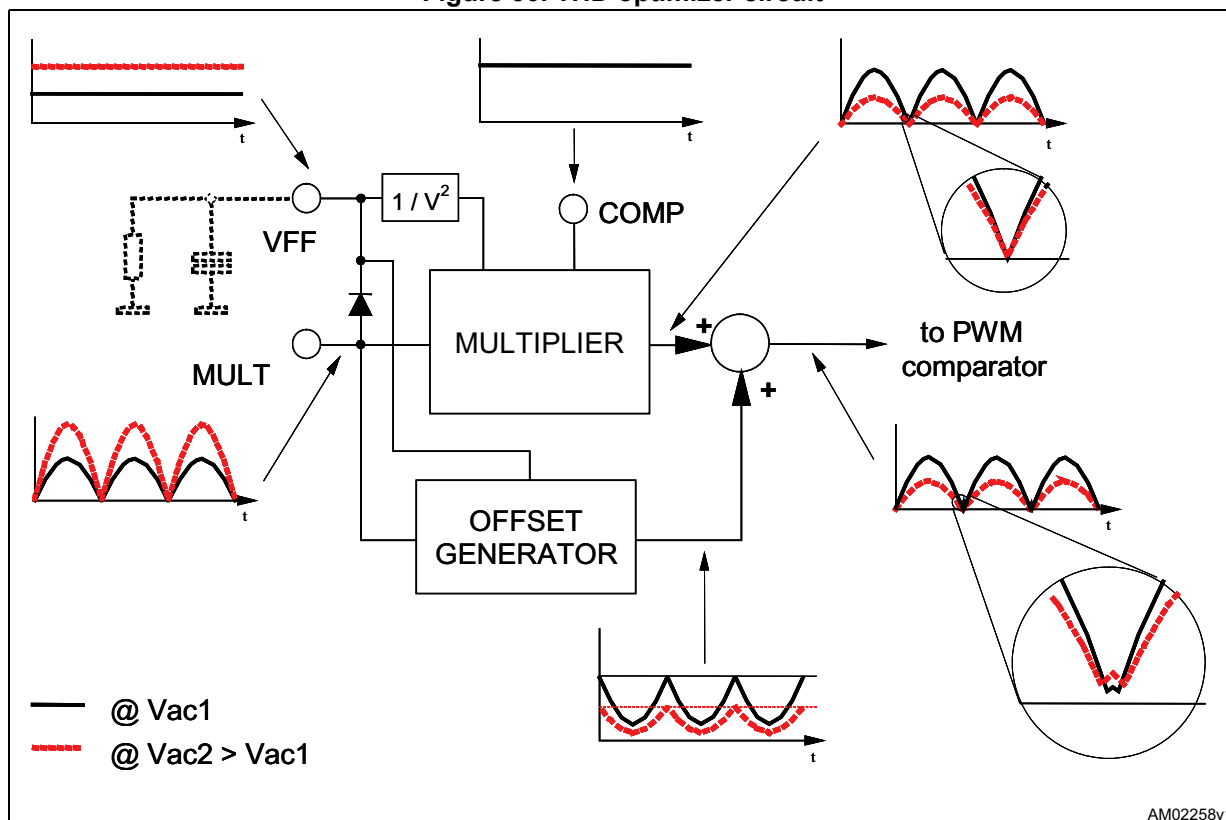
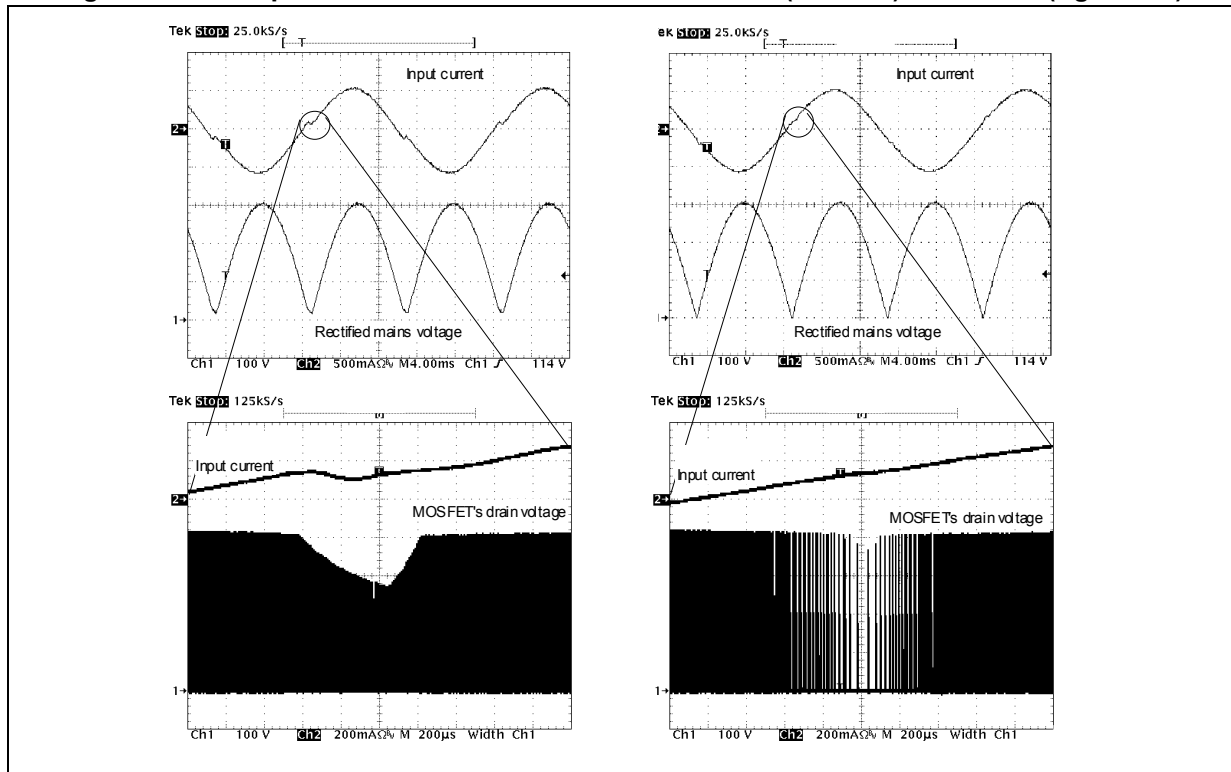


Figure 31. THD optimization: standard TM PFC controller (left side) and L6564 (right side)



Essentially, the circuit artificially increases the ON-time of the power switch with a positive offset added to the output of the multiplier in the proximity of the line voltage zero-crossings. This offset is reduced as the instantaneous line voltage increases, so that it becomes negligible as the line voltage moves toward the top of the sinusoid. Furthermore the offset is modulated by the voltage on the V_{FF} pin (see [Section 6.3: Voltage feed-forward](#)) so as to have little offset at low line, where energy transfer at zero crossings is typically quite good, and a larger offset at high line where the energy transfer gets worse.

The effect of the circuit is shown in [Figure 31](#), where the key waveforms of a standard TM PFC controller are compared to those of this chip.

To take maximum benefit from the THD optimizer circuit, the high-frequency filter capacitor after the bridge rectifier should be minimized, compatibly with EMI filtering needs. A large capacitance, in fact, introduces a conduction dead-angle of the AC input current in itself - even with an ideal energy transfer by the PFC preregulator - thus reducing the effectiveness of the optimizer circuit.

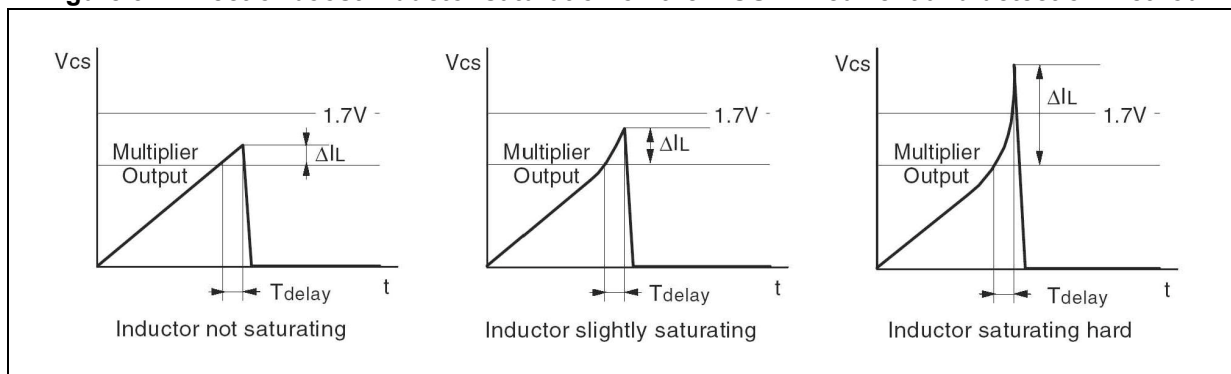
6.5 Inductor saturation detection

Boost inductor's hard saturation may be a fatal event for a PFC preregulator: the current up-slope becomes so large (50 - 100 times steeper, see [Figure 32](#)) that during the current sense propagation delay the current may reach abnormally high values. The voltage drop caused by this abnormal current on the sense resistor reduces the gate-to-source voltage, so that the MOSFET may work in the active region and dissipate a huge amount of power, which leads to a catastrophic failure after few switching cycles.

However, in some applications such as ac-dc adapters, where the PFC preregulator is turned off at light load for energy saving reasons, even a well-designed boost inductor may occasionally slightly saturate when the PFC stage is restarted because of a larger load demand. This happens when the restart occurs at an unfavorable line voltage phase, i.e. when the output voltage is significantly below the rectified peak voltage. As a result, in the boost inductor the inrush current coming from the bridge rectifier adds up to the switched current and, furthermore, there is little or no voltage available for demagnetization.

To cope with a saturated inductor, the L6564 device is provided with a second comparator on the current sense pin (CS, pin 4) that stops the IC if the voltage, normally limited within 1.1 V, exceeds 1.7 V. After that, the IC will be attempted to restart by the internal starter circuitry; the starter repetition time is twice the nominal value to guarantee lower stress for the inductor and boost diode. Hence, the system safety will be considerably increased.

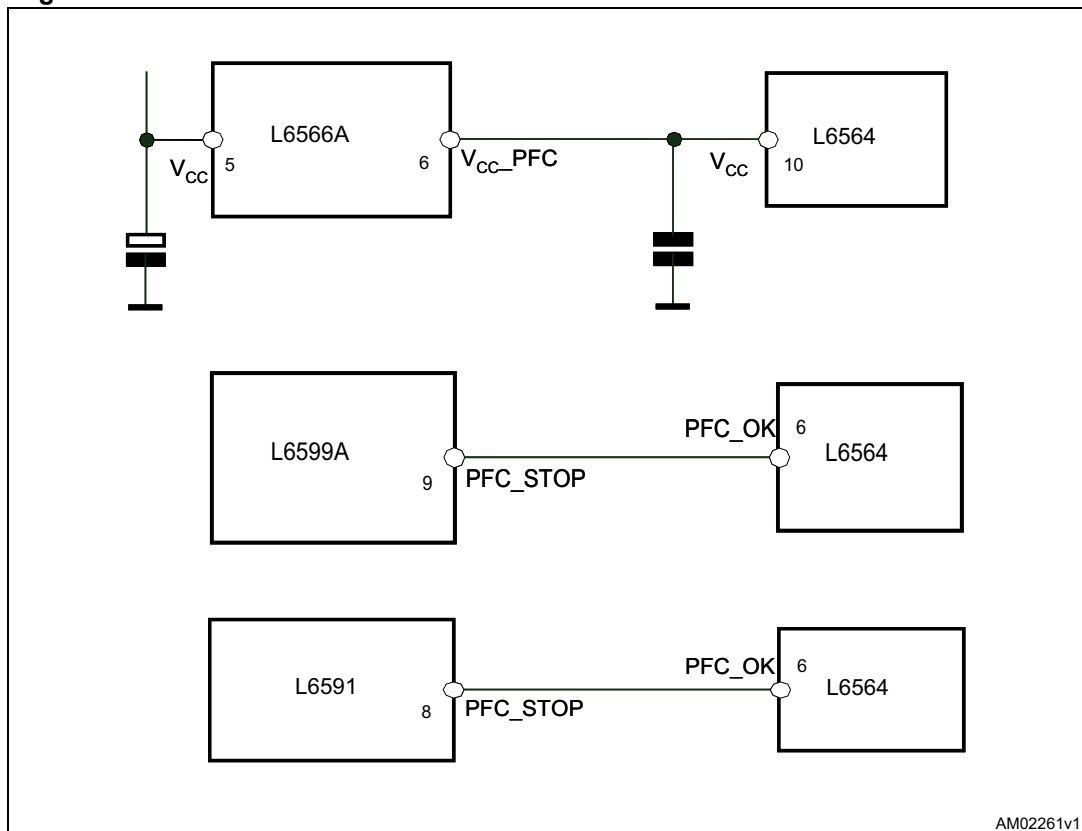
Figure 32. Effect of boost inductor saturation on the MOSFET current and detection method



6.6 Power management/housekeeping functions

A communication line with the control IC of the cascaded dc-dc converter can be established via the disable function included in the PFC_OK pin (see [Section 6.2: Feedback failure protection \(FFP\) on page 19](#) for more details). Typically this line is used to allow the PWM controller of the cascaded dc-dc converter to shut down the L6564 device in case of light load and to minimize the no-load input consumption. Should the residual consumption of the chip be an issue, it is also possible to cut down the supply voltage. Interface circuits like those are shown in [Figure 32](#). Needless to say, this operation assumes that the cascaded dc-dc converter stage works as the master and the PFC stage as the slave or, in other words, that the dc-dc stage starts first, it powers both controllers and enables/disables the operation of the PFC stage.

Figure 33. Interface circuits that let dc-dc converter's controller IC disable the L6564



Another function available is the brownout protection which is basically a not-latched shutdown function that is activated when a condition of mains under voltage is detected. This condition may cause overheating of the primary power section due to an excess of RMS current. Brownout can also cause the PFC preregulator to work open loop and this could be dangerous to the PFC stage itself and the downstream converter, should the input voltage return abruptly to its rated value. Another problem is the spurious restarts that may occur during converter power down and that cause the output voltage of the converter not to decay to zero monotonically. For these reasons it is usually preferable to shutdown the unit in case of brownout. Brownout threshold is internally fixed at 0.8 V and is sensed on pin V_{FF} (5) during the voltage falling and 80 mV threshold hysteresis prevents from rebounding at input voltage turn off. In [Table 5](#) it is possible to find a summary of all of the above mentioned working conditions that cause the device to stop operating.

Table 5. Summary of L6564 idle states

Condition	Caused or revealed by	IC behavior	Restart condition	Typical IC consumption
UVLO	$V_{CC} < V_{CCOff}$	Disabled	$V_{CC} > V_{CCOn}$	90 μ A
Feedback disconnected	PFC_OK > V _{PFC_OK_S} AND INV < 1.66 V	Latched	$V_{CC} < V_{CCrestart}$ then $V_{CC} > V_{CCOn}$	180 μ A
Standby	PFC_OK < V _{PFC_OK_D}	Stop switching	PFC_OK > V _{PFC_OK_E}	1.5 mA
AC brownout	$V_{FF} < V_{DIS}$	Stop switching	RUN > V _{EN}	1.5 mA
OVP	PFC_OK > V _{PFC_OK_S}	Stop switching	PFC_OK < V _{PFC_OK_R}	2.2 mA
Low consumption	COMP < 2.4 V	Burst mode	COMP > 2.4 V	2.2 mA
Saturated boost inductor	$V_{cs} > V_{CS_{th}}$	Doubled T _{start}	Auto restart	2.2 mA

Figure 35. L6564 100W TM PFC: compliance to EN61000-3-2 standard

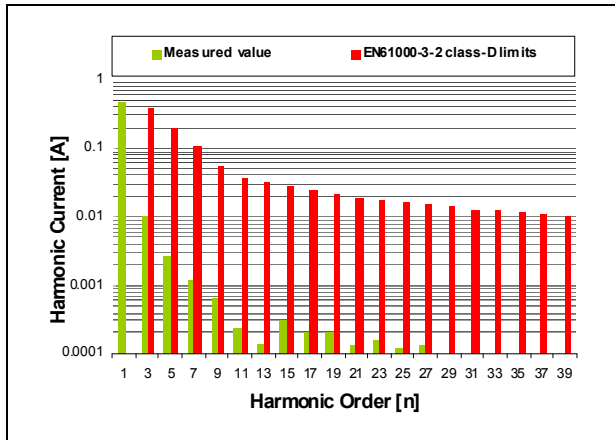


Figure 36. L6564 100W TM PFC: compliance to JEITA-MITI standard

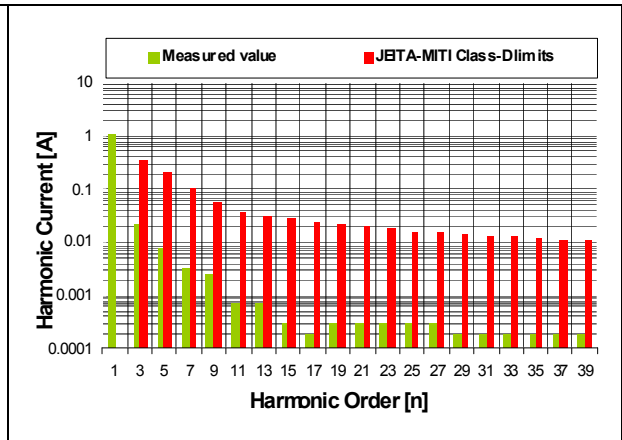


Figure 37. L6564 100 W TM PFC: input current waveform at 230 - 50 Hz - 100 W load

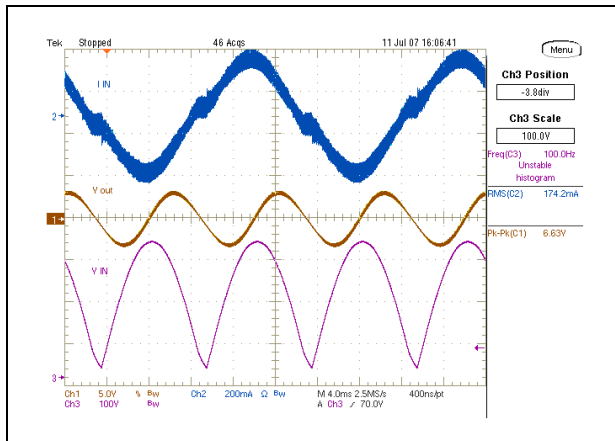
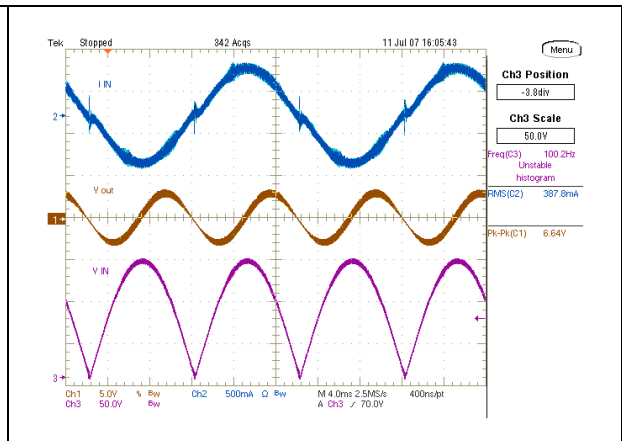


Figure 38. L6564 100W TM PFC: input current waveform at 100 V - 50 Hz - 100 W load



8 Package mechanical data

In order to meet environmental requirements, ST offers these devices in different grades of ECOPACK[®] packages, depending on their level of environmental compliance. ECOPACK specifications, grade definitions and product status are available at: www.st.com. ECOPACK is an ST trademark.

Figure 39. SSOP10 package outline

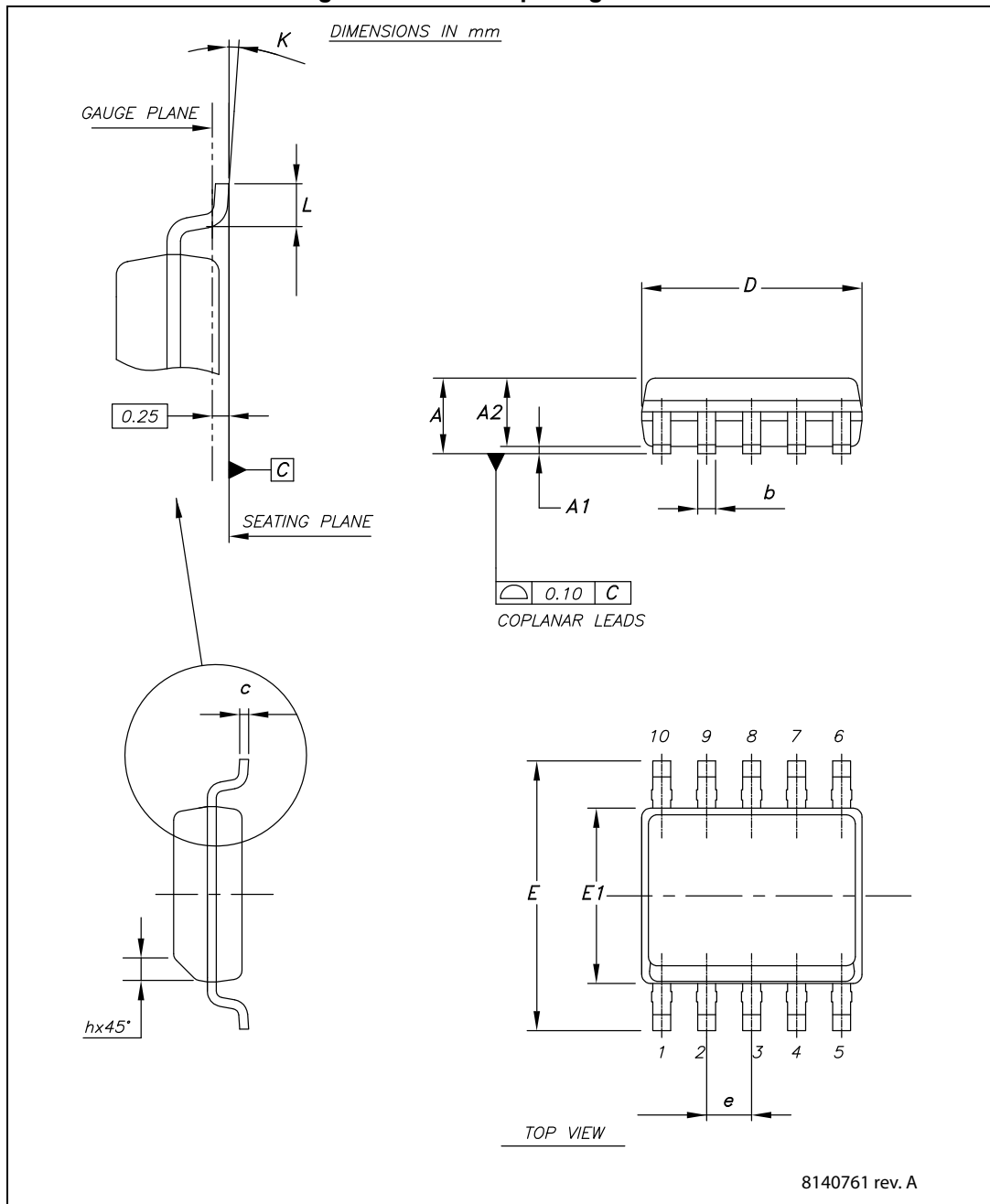


Table 6. SSOP10 package mechanical data

Symbol	Dimensions (mm)		
	Min.	Typ.	Max.
A			1.75
A1	0.10		0.25
A2	1.25		
b	0.31		0.51
c	0.17		0.25
D	4.80	4.90	5
E	5.80	6	6.20
E1	3.80	3.90	4
e		1	
h	0.25		0.50
L	0.40		0.90
K	0°		8°

9 Order codes

Table 7. Ordering information

Order codes	Package	Packing
L6564D	SSOP10	Tube
L6564DTR		Tape and reel

10 Revision history

Table 8. Document revision history

Date	Revision	Changes
08-Sep-2009	1	Initial release.
23-Dec-2010	2	Updated: Figure 1 , Figure 19 , Figure 27 , Figure 29 , Table 3 , Table 4 , Table 5 , Chapter 6.2 , Chapter 6.3 .
28-Sep-2011	3	Updated: Table 4 , Chapter 6.3 and Table 6
20-Oct-2011	4	Updated: Chapter 7
12-Sep-2013	5	Corrected package name in Section 1: Description on page 5 , titles of Figure 39 , Table 6 and Table 7 , reversed order of Figure 39 and Table 6 in Section 8: Package mechanical data on page 29 . Minor modifications throughout document.

L6564

Please Read Carefully:

Information in this document is provided solely in connection with ST products. STMicroelectronics NV and its subsidiaries ("ST") reserve the right to make changes, corrections, modifications or improvements, to this document, and the products and services described herein at any time, without notice.

All ST products are sold pursuant to ST's terms and conditions of sale.

Purchasers are solely responsible for the choice, selection and use of the ST products and services described herein, and ST assumes no liability whatsoever relating to the choice, selection or use of the ST products and services described herein.

No license, express or implied, by estoppel or otherwise, to any intellectual property rights is granted under this document. If any part of this document refers to any third party products or services it shall not be deemed a license grant by ST for the use of such third party products or services, or any intellectual property contained therein or considered as a warranty covering the use in any manner whatsoever of such third party products or services or any intellectual property contained therein.

UNLESS OTHERWISE SET FORTH IN ST'S TERMS AND CONDITIONS OF SALE ST DISCLAIMS ANY EXPRESS OR IMPLIED WARRANTY WITH RESPECT TO THE USE AND/OR SALE OF ST PRODUCTS INCLUDING WITHOUT LIMITATION IMPLIED WARRANTIES OF MERCHANTABILITY, FITNESS FOR A PARTICULAR PURPOSE (AND THEIR EQUIVALENTS UNDER THE LAWS OF ANY JURISDICTION), OR INFRINGEMENT OF ANY PATENT, COPYRIGHT OR OTHER INTELLECTUAL PROPERTY RIGHT.

ST PRODUCTS ARE NOT AUTHORIZED FOR USE IN WEAPONS. NOR ARE ST PRODUCTS DESIGNED OR AUTHORIZED FOR USE IN: (A) SAFETY CRITICAL APPLICATIONS SUCH AS LIFE SUPPORTING, ACTIVE IMPLANTED DEVICES OR SYSTEMS WITH PRODUCT FUNCTIONAL SAFETY REQUIREMENTS; (B) AERONAUTIC APPLICATIONS; (C) AUTOMOTIVE APPLICATIONS OR ENVIRONMENTS, AND/OR (D) AEROSPACE APPLICATIONS OR ENVIRONMENTS. WHERE ST PRODUCTS ARE NOT DESIGNED FOR SUCH USE, THE PURCHASER SHALL USE PRODUCTS AT PURCHASER'S SOLE RISK, EVEN IF ST HAS BEEN INFORMED IN WRITING OF SUCH USAGE, UNLESS A PRODUCT IS EXPRESSLY DESIGNATED BY ST AS BEING INTENDED FOR "AUTOMOTIVE, AUTOMOTIVE SAFETY OR MEDICAL" INDUSTRY DOMAINS ACCORDING TO ST PRODUCT DESIGN SPECIFICATIONS. PRODUCTS FORMALLY ESCC, QML OR JAN QUALIFIED ARE DEEMED SUITABLE FOR USE IN AEROSPACE BY THE CORRESPONDING GOVERNMENTAL AGENCY.

Resale of ST products with provisions different from the statements and/or technical features set forth in this document shall immediately void any warranty granted by ST for the ST product or service described herein and shall not create or extend in any manner whatsoever, any liability of ST.

ST and the ST logo are trademarks or registered trademarks of ST in various countries.

Information in this document supersedes and replaces all information previously supplied.

The ST logo is a registered trademark of STMicroelectronics. All other names are the property of their respective owners.

© 2013 STMicroelectronics - All rights reserved

STMicroelectronics group of companies

Australia - Belgium - Brazil - Canada - China - Czech Republic - Finland - France - Germany - Hong Kong - India - Israel - Italy - Japan - Malaysia - Malta - Morocco - Philippines - Singapore - Spain - Sweden - Switzerland - United Kingdom - United States of America

www.st.com



OUR CERTIFICATE

DiGi provide top-quality products and perfect service for customer worldwide through standardization, technological innovation and continuous improvement. DiGi through third-party certification, we stricly control the quality of products and services. Welcome your RFQ to

Email: Info@DiGi-Electronics.com



Tel: +00 852-30501935

RFQ Email: Info@DiGi-Electronics.com

DiGi is a global authorized distributor of electronic components.