

LD2980CM50TR Datasheet

www.digi-electronics.com

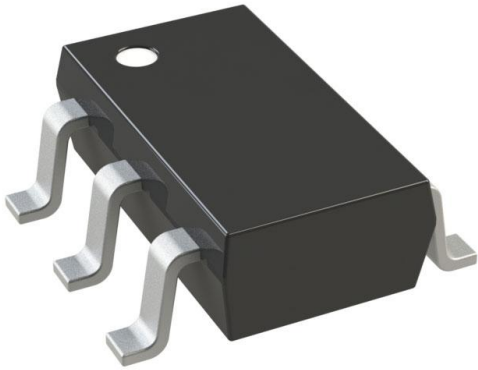

<https://www.DiGi-Electronics.com>

DiGi Electronics Part Number	LD2980CM50TR-DG
Manufacturer	STMicroelectronics
Manufacturer Product Number	LD2980CM50TR
Description	IC REG LINEAR 5V 50MA SOT23-5
Detailed Description	Linear Voltage Regulator IC Positive Fixed 1 Output 50mA SOT-23-5

This model LD2980CM50TR is available at DiGi Electronics.

DiGi Electronics offers a global database of semiconductor and electronic component datasheets.

We welcome your inquiries regarding pricing, lead time, or other product-related questions.

 [Request a Quote](#)

 [Datasheet Search](#)



Tel: +00 852-30501935

RFQ Email: Info@DiGi-Electronics.com

DiGi is a global authorized distributor of electronic components.

Purchase and inquiry

Manufacturer Product Number:

LD2980CM50TR

Series:

-

Output Configuration:

Positive

Number of Regulators:

1

Voltage - Output (Min/Fixed):

5V

Voltage Dropout (Max):

0.225V @ 50mA

Current - Quiescent (Iq):

150 μ A

PSRR:

63dB (1kHz)

Protection Features:

Over Current, Over Temperature

Mounting Type:

Surface Mount

Supplier Device Package:

SOT-23-5

Manufacturer:

STMicroelectronics

Product Status:

Active

Output Type:

Fixed

Voltage - Input (Max):

16V

Voltage - Output (Max):

-

Current - Output:

50mA

Current - Supply (Max):

1.2 mA

Control Features:

Enable

Operating Temperature:

-40°C ~ 125°C

Package / Case:

SC-74A, SOT-753

Base Product Number:

LD2980

Environmental & Export classification

RoHS Status:

ROHS3 Compliant

REACH Status:

REACH Unaffected

HTSUS:

8542.39.0001

Moisture Sensitivity Level (MSL):

1 (Unlimited)

ECCN:

EAR99

Ultra low drop voltage regulators compatible with low ESR output capacitors

Datasheet - production data

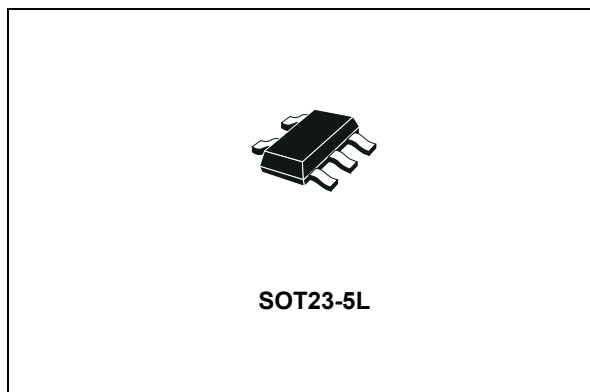

Description

The low drop voltage and the ultra low quiescent current make them suitable for low noise, low power applications and in battery powered systems. The quiescent current in sleep mode is less than 1 μA when the INHIBIT pin is pulled low. A shutdown logic control function is available on pin n° 3 (TTL compatible). This means that when the device is used as local regulator, it is possible to put a part of the board in standby, decreasing the total power consumption. The LD2980 is designed to work with low ESR ceramic capacitors. Typical applications are cellular phone, laptop computer, personal digital assistant (PDA), personal stereo, camcorder and camera.

Features

- Stable with low ESR ceramic capacitors
- Ultra low dropout voltage (0.12 V typ. at 50 mA load, 7 mV typ. at 1 mA load)
- Very low quiescent current (80 μA typ. at no load in on mode; max 1 μA in off mode)
- Guaranteed output current up to 50 mA
- Logic-controlled electronic shutdown
- Output voltage of 1.8; 3.0; 3.3; 5.0 V
- Internal current and thermal limit
- $\pm 0.5\%$ Tolerance output voltage available (A version)
- Output low noise voltage 160 μVRMS
- Temperature range: -40 to 125 °C
- Smallest package SOT23-5L
- Fast dynamic response to line and load changes

Table 1. Device summary

Part numbers		
AB version	C version	Output voltage
	LD2980CM18TR	1.8 V
LD2980ABM30TR		3.0 V
LD2980ABM33TR	LD2980CM33TR	3.3 V
LD2980ABM50TR	LD2980CM50TR	5.0 V

Contents

1	Diagram	3
2	Pin configuration	4
3	Maximum ratings	5
4	Typical application	6
5	Electrical characteristics	7
6	Typical performance characteristics	11
7	Application notes	15
	7.1 External capacitors	15
	7.2 Input capacitor	15
	7.3 Output capacitor	15
	7.4 Important	15
	7.5 Inhibit input operation	15
	7.6 Reverse current	16
8	Package mechanical data	17
9	Packaging mechanical data	19
10	Revision history	21

1 Diagram

Figure 1. Schematic diagram

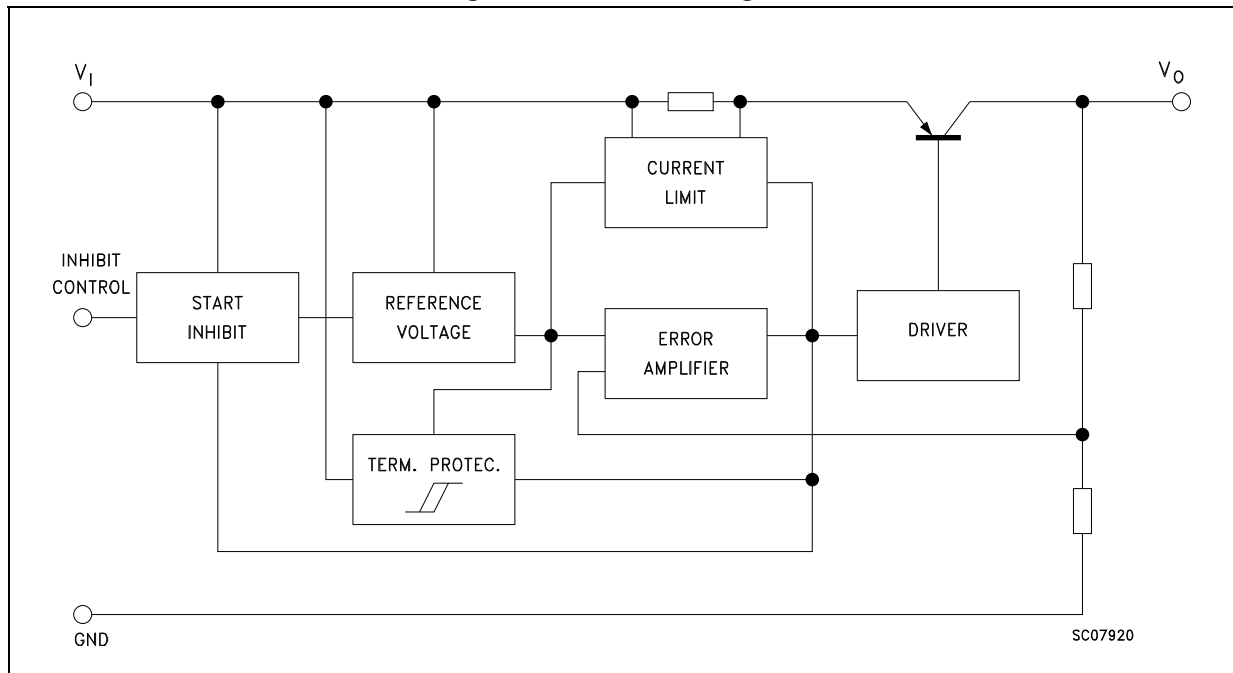

2 Pin configuration

Figure 2. Pin connections (top view)

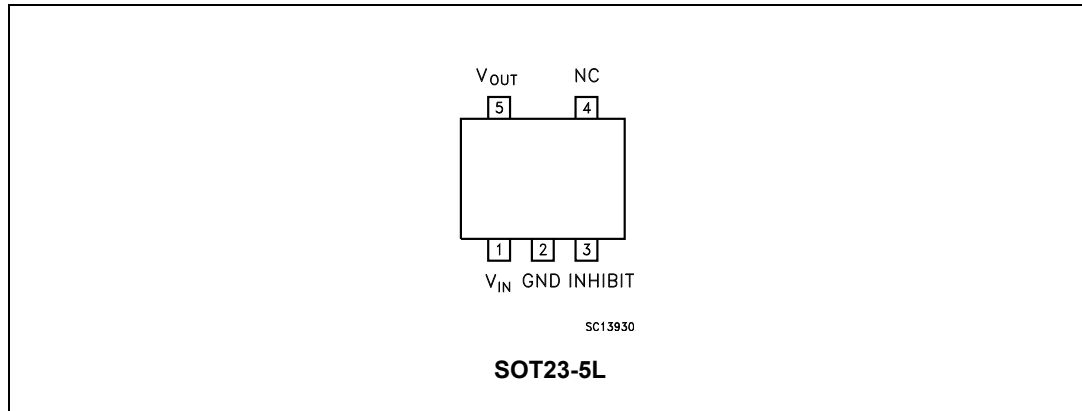

Table 2. Pin description

Pin n°	Symbol	Name and function
1	V_{IN}	Input port
2	GND	Ground pin
3	INHIBIT	Control switch ON/OFF. Inhibit is not internally pulled-up; it cannot be left floating. Disable the device when connected to GND or to a positive voltage less than 0.18 V
4	NC	Not connected
5	V_{OUT}	Output port

Table 3. Thermal data

Symbol	Parameter	Value	Unit
R_{thJC}	Thermal resistance junction-case	81	°C/W
R_{thJA}	Thermal resistance junction-ambient	255	°C/W

3 Maximum ratings

Table 4. Absolute maximum ratings

Symbol	Parameter	Value	Unit
V_I	DC input voltage	-0.3 to 16	V
V_{INH}	INHIBIT input voltage	-0.3 to 16	V
I_O	Output current	Internally limited	
P_D	Power dissipation	Internally limited	
T_{STG}	Storage temperature range	-55 to 150	°C
T_{OP}	Operating junction temperature range	-40 to 125	°C

Note: Absolute maximum ratings are those values beyond which damage to the device may occur. Functional operation under these condition is not implied.

4 Typical application

Figure 3. Application circuit

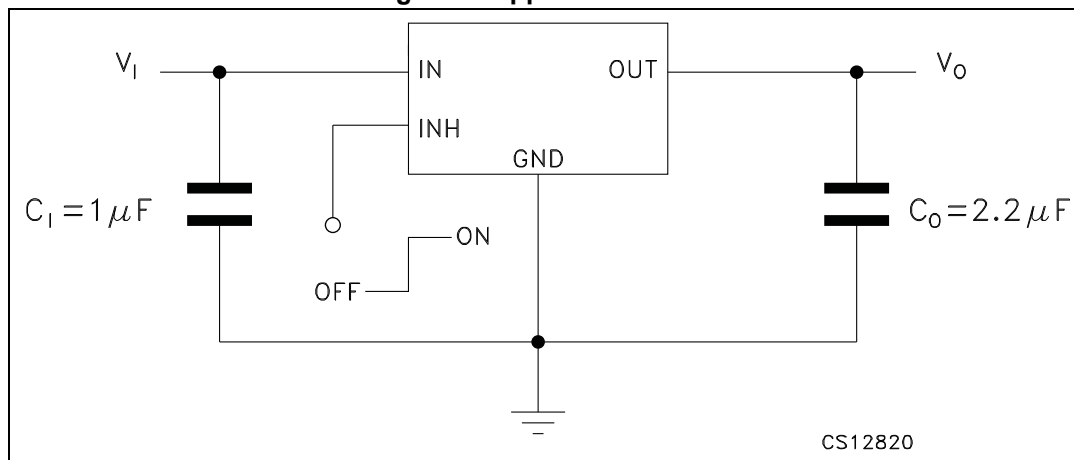

Note: Inhibit pin is not internally pulled-up then it must not be left floating. Disable the device when connected to GND or to a positive voltage less than 0.18 V.

5 Electrical characteristics

($T_J = 25\text{ °C}$, $V_I = V_{O(NOM)} + 1\text{ V}$, $C_I = 1\text{ }\mu\text{F}$, $C_O = 2.2\text{ }\mu\text{F}$, $I_O = 1\text{ mA}$, $V_{INH} = 2\text{ V}$, unless otherwise specified).

Table 5. Electrical characteristics for LD2980ABM

Symbol	Parameter	Test conditions	Min.	Typ.	Max.	Unit
V_{OP}	Operating input voltage		2.5		16	V
V_O	Output voltage	$I_O = 1\text{ mA}$	2.985	3	3.015	V
		$I_O = 1\text{ to }50\text{ mA}$	2.978		3.023	
		$I_O = 1\text{ to }50\text{ mA}$, $T_J = -40\text{ to }125\text{ °C}$	2.925		3.075	
V_O	Output voltage	$I_O = 1\text{ mA}$	3.284	3.3	3.317	V
		$I_O = 1\text{ to }50\text{ mA}$	3.275		3.325	
		$I_O = 1\text{ to }50\text{ mA}$, $T_J = -40\text{ to }125\text{ °C}$	3.217		3.383	
V_O	Output voltage	$I_O = 1\text{ mA}$	4.975	5	5.025	V
		$I_O = 1\text{ to }50\text{ mA}$	4.963		5.038	
		$I_O = 1\text{ to }50\text{ mA}$, $T_J = -40\text{ to }125\text{ °C}$	4.875		5.125	
ΔV_O	Line regulation	$V_{O(NOM)} + 1 < V_{IN} < 16\text{ V}$, $I_O = 1\text{ mA}$		0.003	0.014	%V
		$T_J = -40\text{ to }125\text{ °C}$			0.032	
I_Q	Quiescent current ON MODE	$I_O = 0$		80	100	μA
		$I_O = 0$, $T_J = -40\text{ to }125\text{ °C}$			150	
		$I_O = 1\text{ mA}$		100	150	
		$I_O = 1\text{ mA}$, $T_J = -40\text{ to }125\text{ °C}$			200	
		$I_O = 10\text{ mA}$		175	250	
		$I_O = 10\text{ mA}$, $T_J = -40\text{ to }125\text{ °C}$			450	
		$I_O = 50\text{ mA}$		500	700	
		$I_O = 50\text{ mA}$, $T_J = -40\text{ to }125\text{ °C}$			1200	
	OFF MODE	$V_{INH} < 0.18\text{ V}$		0		
		$V_{INH} < 0.18\text{ V}$, $T_J = -40\text{ to }125\text{ °C}$			1	
V_{DROP}	Dropout voltage ⁽¹⁾	$I_O = 0$		1	3	mV
		$I_O = 0$, $T_J = -40\text{ to }125\text{ °C}$			5	
		$I_O = 1\text{ mA}$		7	10	
		$I_O = 1\text{ mA}$, $T_J = -40\text{ to }125\text{ °C}$			15	
		$I_O = 10\text{ mA}$		40	60	
		$I_O = 10\text{ mA}$, $T_J = -40\text{ to }125\text{ °C}$			90	
		$I_O = 50\text{ mA}$		120	150	
		$I_O = 50\text{ mA}$, $T_J = -40\text{ to }125\text{ °C}$			225	

Table 5. Electrical characteristics for LD2980ABM (continued)

Symbol	Parameter	Test conditions	Min.	Typ.	Max.	Unit
I_{SC}	Short circuit current	$R_L = 0$		150		mA
SVR	Supply voltage rejection	$C_O = 10\mu\text{F}$, $f = 1\text{kHz}$		63		dB
V_{INH}	Inhibit input logic low	LOW = Output OFF, $T_J = -40$ to 125°C		0.8	0.18	V
V_{INL}	Inhibit input logic high	HIGH = Output ON, $T_J = -40$ to 125°C	1.6	1.3		V
I_{INH}	Inhibit input current	$V_{INH} = 0\text{V}$, $T_J = -40$ to 125°C		0	-1	μA
		$V_{INH} = 5\text{V}$, $T_J = -40$ to 125°C		5	15	
e_N	Output noise voltage	$B_W = 300\text{ Hz to } 50\text{ kHz}$, $C_O = 10\mu\text{F}$		160		μV_{RMS}
T_{SHDN}	Thermal shutdown			170		$^\circ\text{C}$

- For $V_O < 2.5\text{ V}$ dropout voltage can be calculated according to the minimum input voltage in full temperature range.

($T_J = 25\text{ }^\circ\text{C}$, $V_I = V_{O(NOM)} + 1\text{ V}$, $C_I = 1\text{ }\mu\text{F}$, $C_O = 2.2\text{ }\mu\text{F}$, $I_O = 1\text{ mA}$, $V_{INH} = 2\text{ V}$, unless otherwise specified).

Table 6. Electrical characteristics for LD2980CM

Symbol	Parameter	Test conditions	Min.	Typ.	Max.	Unit
V_{OP}	Operating input voltage		2.5		16	V
V_O	Output voltage	$I_O = 1\text{ mA}$	1.782	1.8	1.818	V
		$I_O = 1\text{ to }50\text{ mA}$	1.773		1.827	
		$I_O = 1\text{ to }50\text{ mA}$, $T_J = -40\text{ to }125\text{ }^\circ\text{C}$	1.737		1.863	
V_O	Output voltage	$I_O = 1\text{ mA}$	3.267	3.3	3.333	V
		$I_O = 1\text{ to }50\text{ mA}$	3.251		3.35	
		$I_O = 1\text{ to }50\text{ mA}$, $T_J = -40\text{ to }125\text{ }^\circ\text{C}$	3.184		3.415	
V_O	Output voltage	$I_O = 1\text{ mA}$	4.95	5	5.05	V
		$I_O = 1\text{ to }50\text{ mA}$	4.925		5.075	
		$I_O = 1\text{ to }50\text{ mA}$, $T_J = -40\text{ to }125\text{ }^\circ\text{C}$	4.825		5.175	
ΔV_O	Line regulation	$V_{O(NOM)} + 1 < V_{IN} < 16\text{ V}$, $I_O = 1\text{ mA}$		0.003	0.014	%V
		$T_J = -40\text{ to }125\text{ }^\circ\text{C}$			0.032	
I_Q	Quiescent current ON MODE	$I_O = 0$		80	100	μA
		$I_O = 0$, $T_J = -40\text{ to }125\text{ }^\circ\text{C}$			150	
		$I_O = 1\text{ mA}$		100	150	
		$I_O = 1\text{ mA}$, $T_J = -40\text{ to }125\text{ }^\circ\text{C}$			200	
		$I_O = 10\text{ mA}$		175	250	
		$I_O = 10\text{ mA}$, $T_J = -40\text{ to }125\text{ }^\circ\text{C}$			450	
		$I_O = 50\text{ mA}$		500	700	
		$I_O = 50\text{ mA}$, $T_J = -40\text{ to }125\text{ }^\circ\text{C}$			1200	
	OFF MODE	$V_{INH} < 0.18\text{ V}$		0		
		$V_{INH} < 0.18\text{ V}$, $T_J = -40\text{ to }125\text{ }^\circ\text{C}$			1	
V_{DROP}	Dropout voltage ⁽¹⁾	$I_O = 0$		1	3	mV
		$I_O = 0$, $T_J = -40\text{ to }125\text{ }^\circ\text{C}$			5	
		$I_O = 1\text{ mA}$		7	10	
		$I_O = 1\text{ mA}$, $T_J = -40\text{ to }125\text{ }^\circ\text{C}$			15	
		$I_O = 10\text{ mA}$		40	60	
		$I_O = 10\text{ mA}$, $T_J = -40\text{ to }125\text{ }^\circ\text{C}$			90	
		$I_O = 50\text{ mA}$		120	150	
		$I_O = 50\text{ mA}$, $T_J = -40\text{ to }125\text{ }^\circ\text{C}$			225	
I_{SC}	Short circuit current	$R_L = 0$		150		mA
SVR	Supply voltage rejection	$C_O = 10\text{ }\mu\text{F}$, $f = 1\text{ kHz}$		63		dB

Table 6. Electrical characteristics for LD2980CM (continued)

Symbol	Parameter	Test conditions	Min.	Typ.	Max.	Unit
V_{INH}	Inhibit input logic low	LOW = Output OFF, $T_J = -40$ to 125°C		0.8	0.18	V
V_{INL}	Inhibit input logic high	HIGH = Output ON, $T_J = -40$ to 125°C	1.6	1.3		V
I_{INH}	Inhibit input current	$V_{INH} = 0\text{V}$, $T_J = -40$ to 125°C		0	-1	μF
		$V_{INH} = 5\text{V}$, $T_J = -40$ to 125°C		5	15	
e_N	Output noise voltage	$B_W = 300$ Hz to 50 kHz, $C_O = 10\mu\text{F}$		160		μV_{RMS}
T_{SHDN}	Thermal shutdown			170		$^\circ\text{C}$

- For $V_O < 2.5$ V dropout voltage can be calculated according to the minimum input voltage in full temperature range.

6 Typical performance characteristics

($T_J = 25\text{ }^\circ\text{C}$, $V_I = V_{O(NOM)} + 1\text{ V}$, $C_I = 1\text{ }\mu\text{F}$, $C_O = 2.2\text{ }\mu\text{F}$, $V_{INH} = 2\text{ V}$, unless otherwise specified)

Figure 4. Output voltage vs temperature

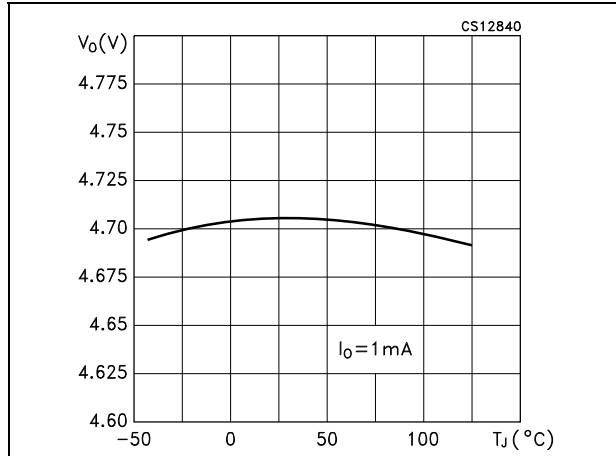

Figure 5. Output voltage vs temperature

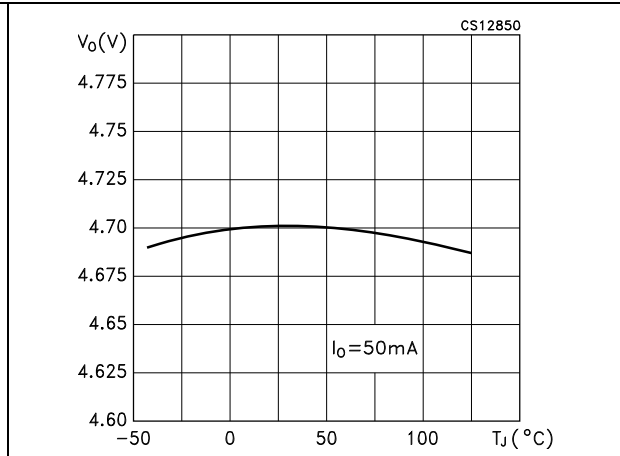

Figure 6. Line regulation vs temperature

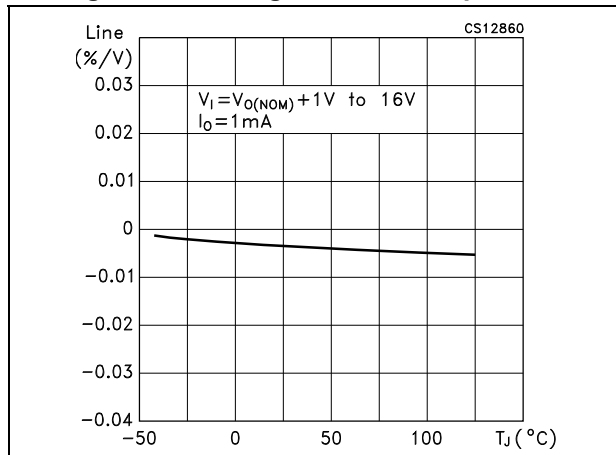

Figure 7. Load regulation vs temperature

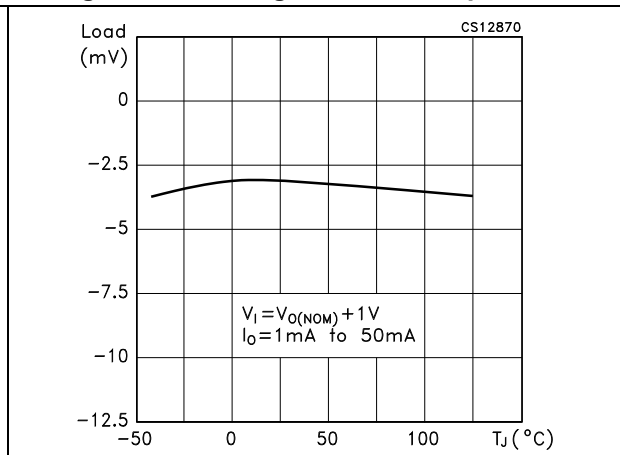

Figure 8. Dropout voltage vs temperature

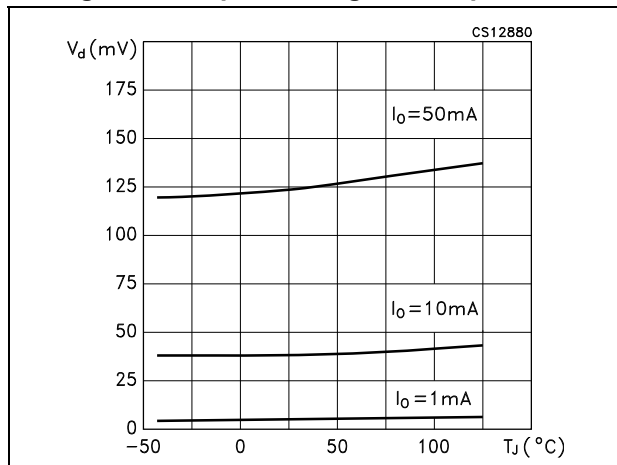

Figure 9. Quiescent current vs temperature

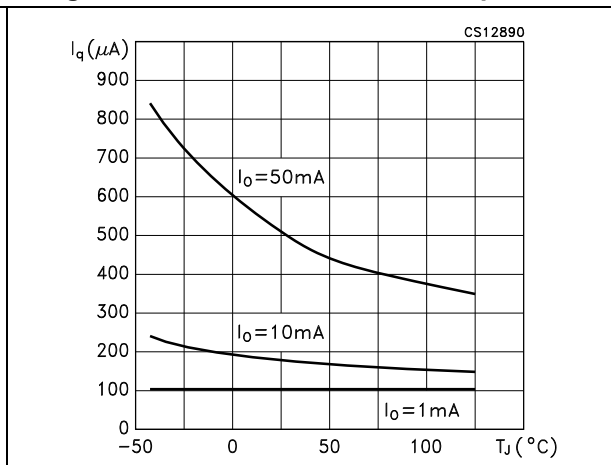

Figure 10. Quiescent current vs output current

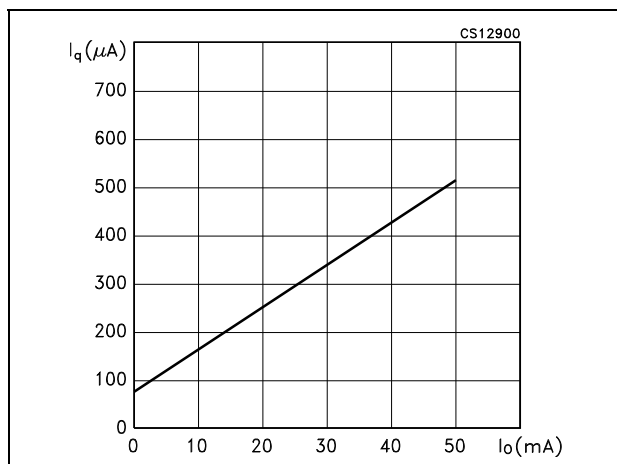

Figure 11. Off mode quiescent current vs temperature

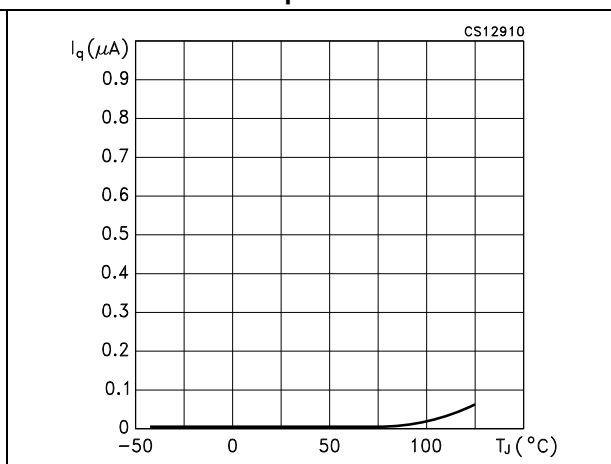

Figure 12. Quiescent current vs input voltage

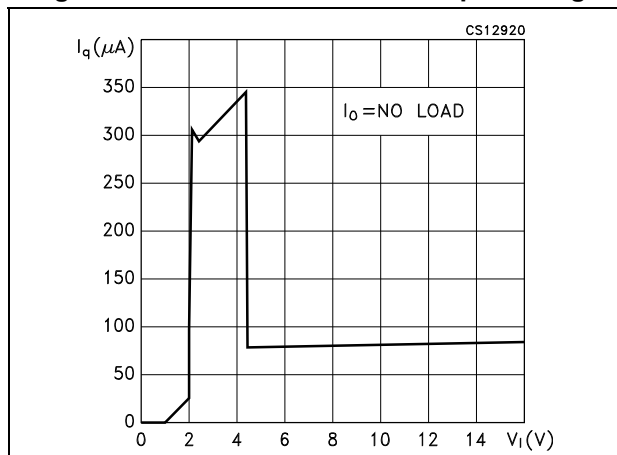

Figure 13. Dropout voltage vs output current

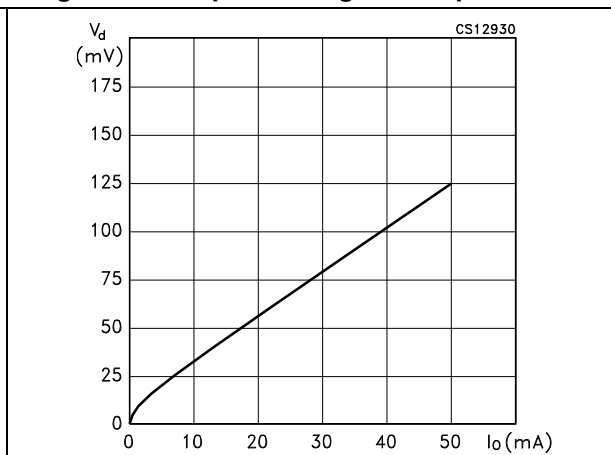

Figure 14. Inhibit input current vs temperature

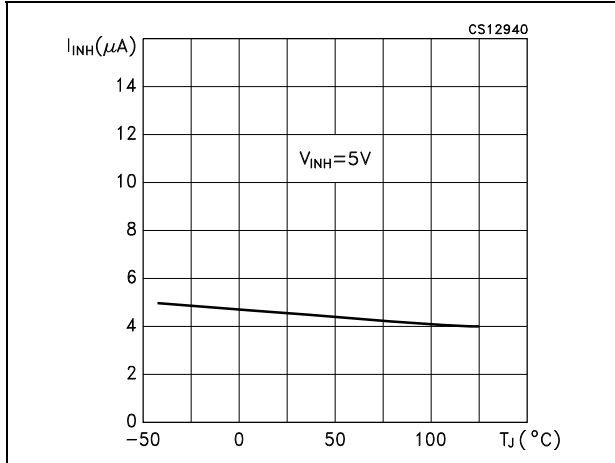

Figure 15. Inhibit voltage vs temperature

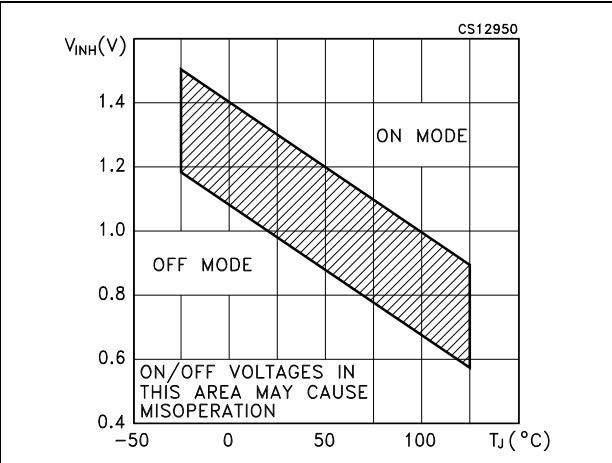

Figure 16. Supply voltage rejection vs frequency

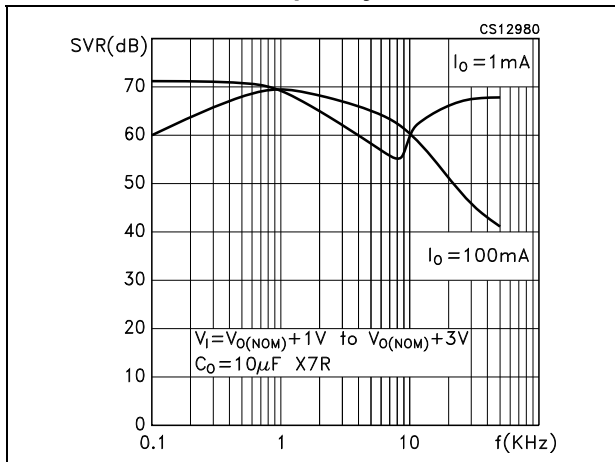

Figure 17. Noise voltage vs frequency

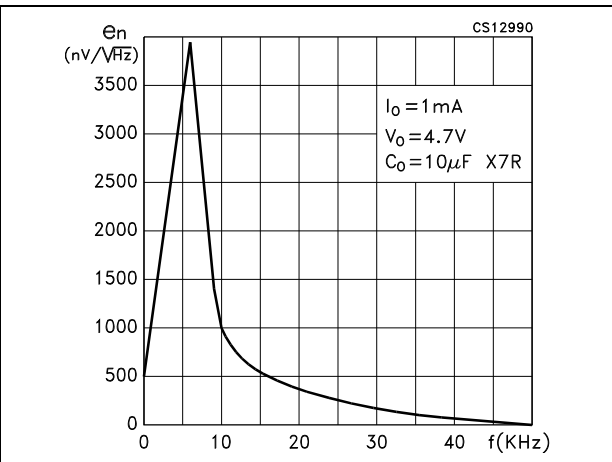

Figure 18. Best case: highest output version

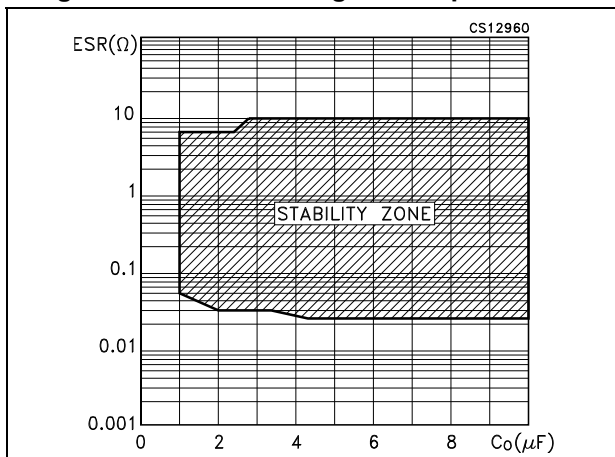

Figure 19. Worst case: lowest output version

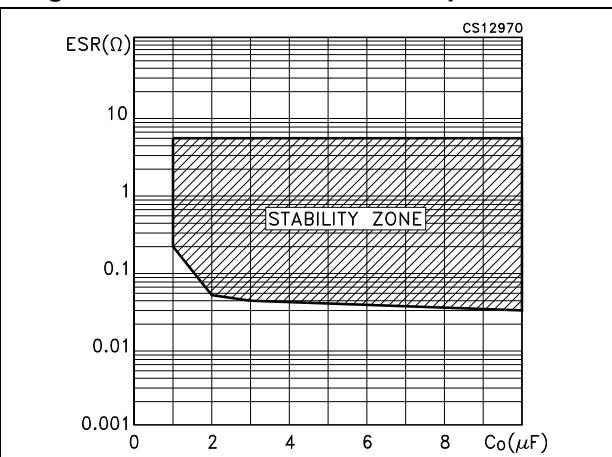

Figure 20. Load transient response

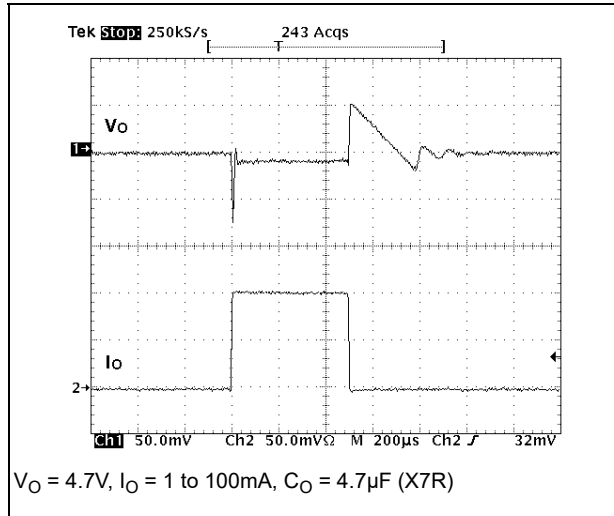
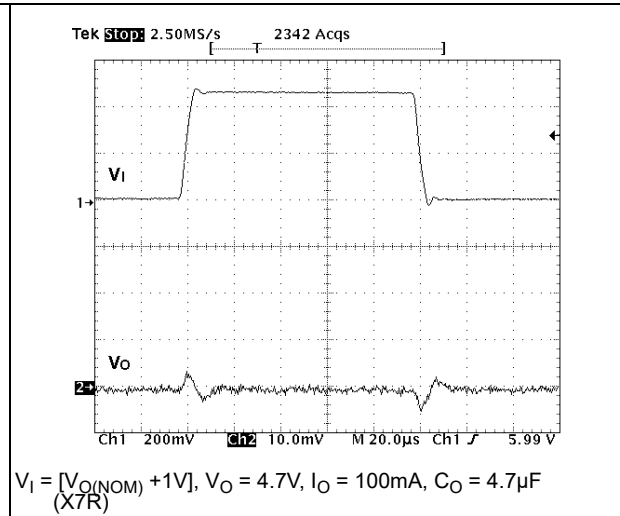

Figure 21. Line transient response



7 Application notes

7.1 External capacitors

Like any low-dropout regulator, the LD2980 requires external capacitors for regulator stability. This capacitor must be selected to meet the requirements of minimum capacitance and equivalent series resistance (please refer to [Figure 18](#) and [Figure 19](#)). We suggest to solder input and output capacitors as close as possible to the relative pins.

7.2 Input capacitor

An input capacitor whose value is 1 μF is required with the LD2980 (amount of capacitance can be increased without limit). This capacitor must be located a distance of not more than 0.5" from the input pin of the device and returned to a clean analog ground. Any good quality ceramic, tantalum or film capacitors can be used for this capacitor.

7.3 Output capacitor

The LD2980 is designed specifically to work with ceramic output capacitors. It may also be possible to use Tantalum capacitors, but these are not as attractive for reasons of size and cost. By the way, the output capacitor must meet both the requirement for minimum amount of capacitance and ESR (equivalent series resistance) value. The [Figure 18](#) and [Figure 19](#) show the allowable ESR range as a function of the output capacitance. These curves represent the stability region over the full temperature and I_O range. Due to the different loop gain, the stability improves for higher output versions and so the suggested minimum output capacitor value, if low ESR ceramic type is used, is 1 μF for output voltages equal or major than 3.8 V, 2.2 μF for output voltages from 2.85 to 3.3 V, and 3.3 μF for the other versions. However, if an output capacitor lower than the suggested one is used, it's possible to make stable the regulator adding a resistor in series to the capacitor (see [Figure 18](#) and [Figure 19](#) to choose the right value according to the used version and keeping in account that the ESR of ceramic capacitors has been measured @ 100 kHz).

7.4 Important

The output capacitor must maintain its ESR in the stable region over the full operating temperature to assure stability. Also, capacitor tolerance and variation with temperature must be considered to assure the minimum amount of capacitance is provided at all times. This capacitor should be located not more than 0.5" from the output pin of the device and returned to a clean analog ground.

7.5 Inhibit input operation

The inhibit pin can be used to turn OFF the regulator when pulled low, so drastically reducing the current consumption down to less than 1 μA . When the inhibit feature is not used, this pin must be tied to V_I to keep the regulator output ON at all times. To assure proper operation, the signal source used to drive the inhibit pin must be able to swing above

and below the specified thresholds listed in the electrical characteristics section under V_{IH} V_{IL} . Any slew rate can be used to drive the inhibit.

7.6 Reverse current

The power transistor used in the LD2980 has not an inherent diode connected between the regulator input and output. If the output is forced above the input, no current will flow from the output to the input across the series pass transistor. When a V_{REV} voltage is applied on the output, the reverse current measured, according to the test circuit in [Figure 22](#), flows to the GND across the two feedback resistors. This current typical value is $160 \mu\text{A}$. R_1 and R_2 resistors are implanted type; typical values are, respectively, $42.6 \text{ k}\Omega$ and $51.150 \text{ k}\Omega$.

Figure 22. Reverse current test circuit

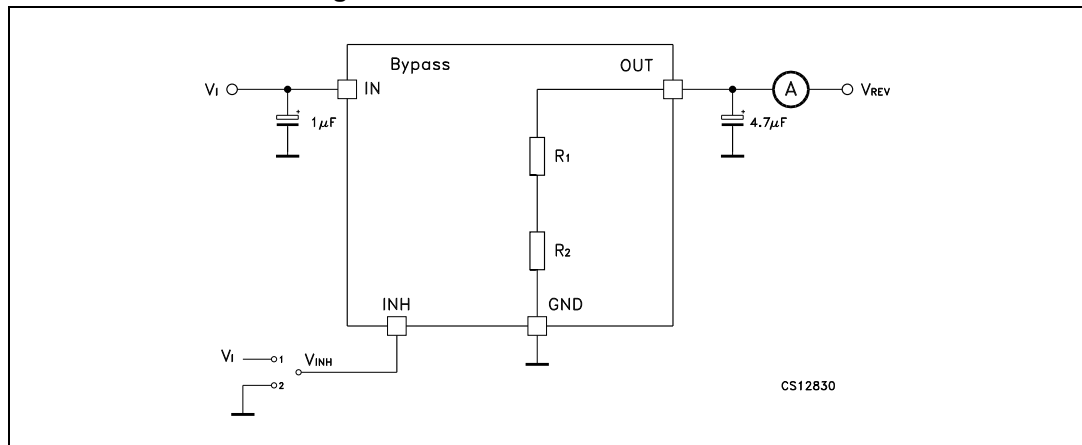

8 Package mechanical data

In order to meet environmental requirements, ST offers these devices in different grades of ECOPACK packages, depending on their level of environmental compliance. ECOPACK specifications, grade definitions and product status are available at: www.st.com. ECOPACK is an ST trademark.

Table 7. SOT23-5L mechanical data

Dim.	mm		
	Min.	Typ.	Max.
A	0.90		1.45
A1	0		0.15
A2	0.90		1.30
b	0.30		0.50
c	2.09		0.20
D		2.95	
E		1.60	
e		0.95	
H		2.80	
L	0.30		0.60
θ	0		8

Figure 23. SOT23-5L mechanical drawing

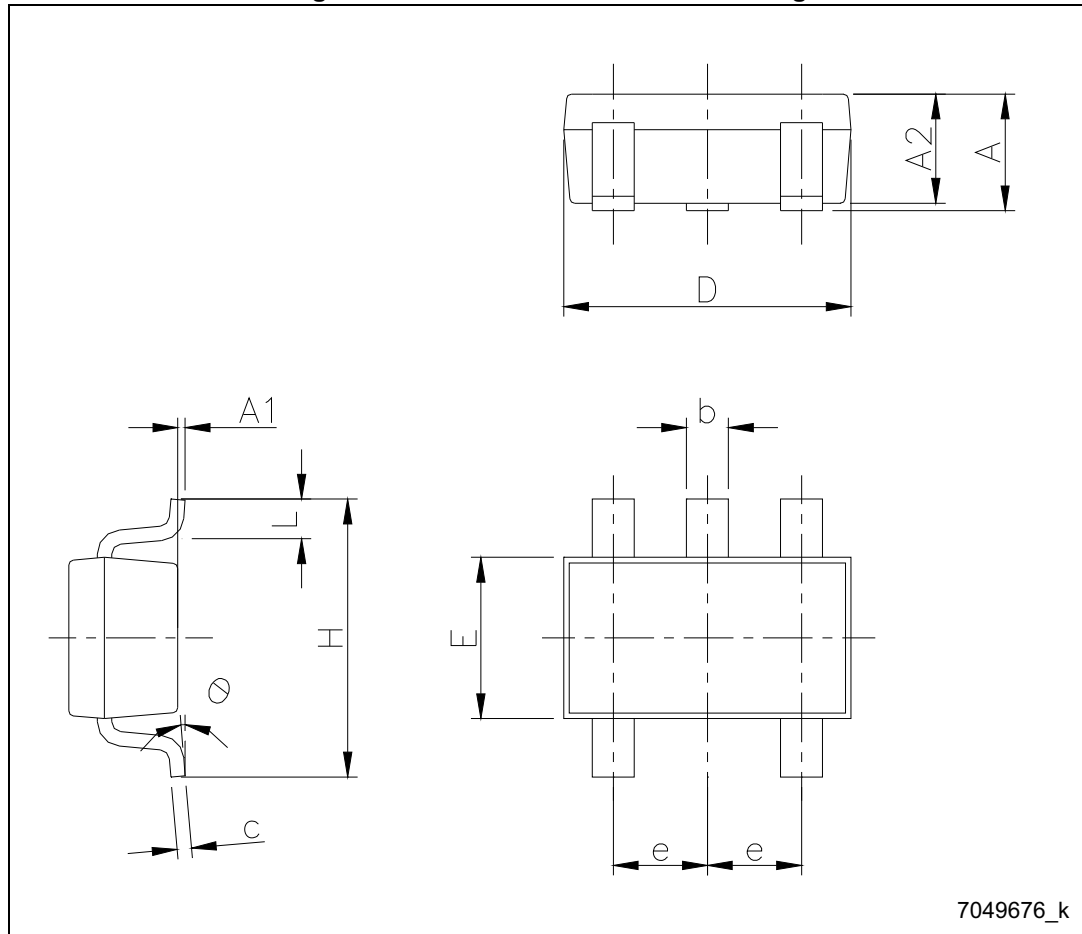

Figure 24. SOT23-5L recommended footprint (dimensions in mm)

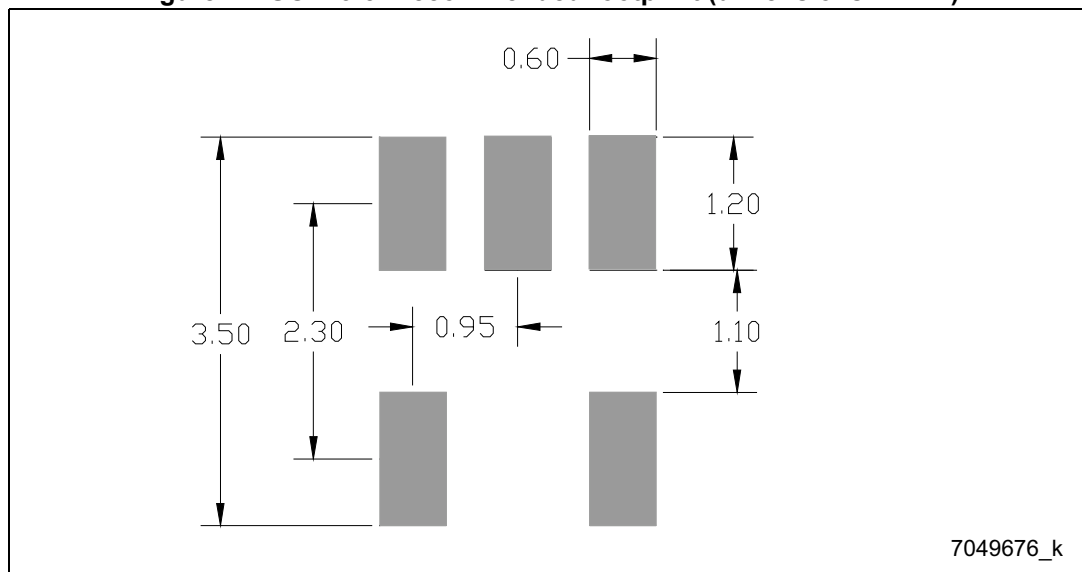

Figure 26. SOT23-5L oriented tape outline

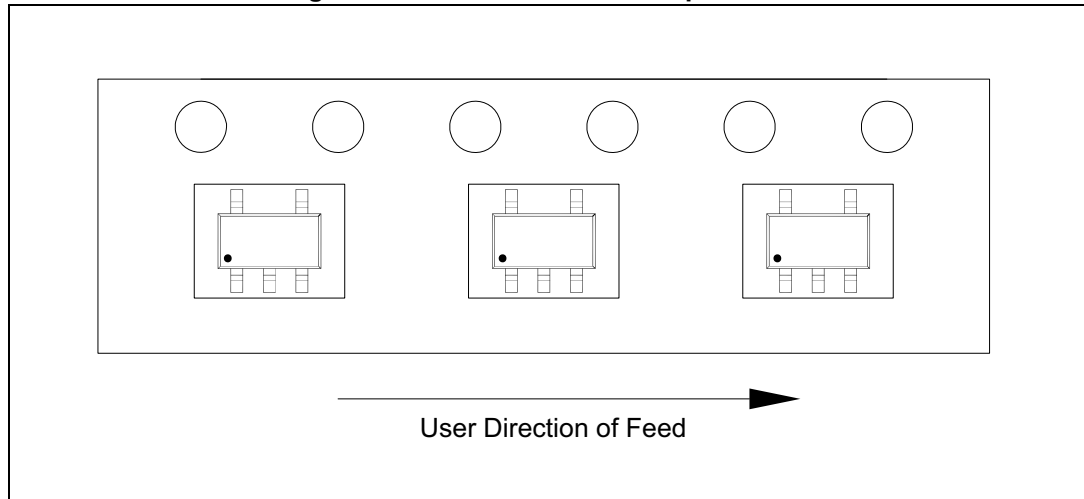

Figure 27. SOT23-5L reel outline

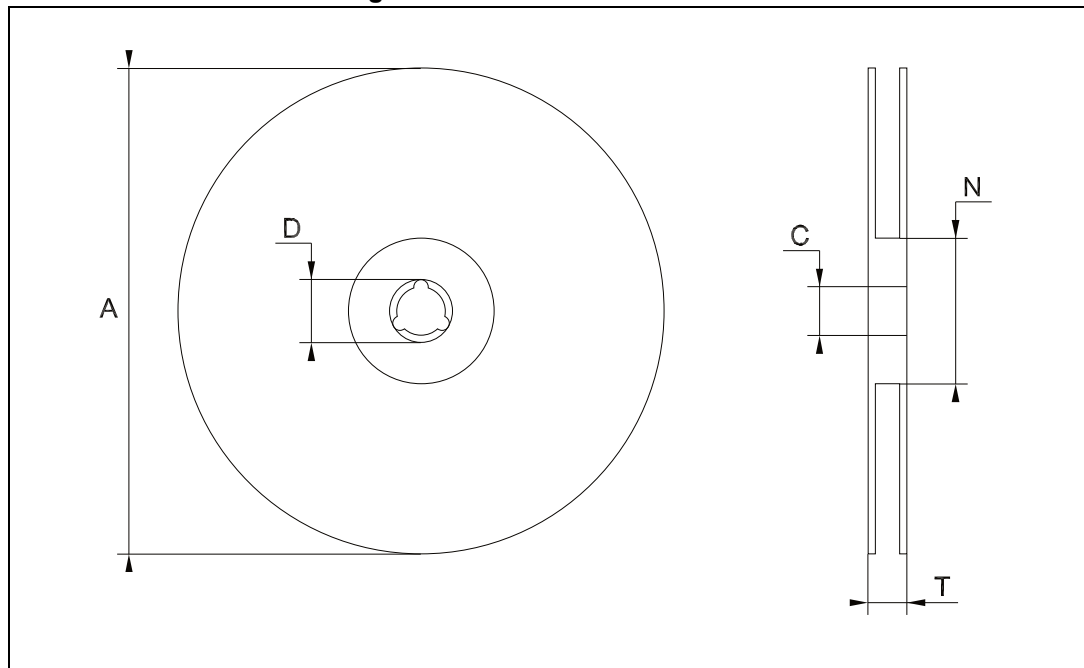

Table 8. SOT23-5L reel mechanical data

Symbol	Dimensions (mm)		
	Min.	Typ.	Max.
A	-	-	180
C	12.8	13.0	13.2
D	20.2	-	-
N	60	-	-
T	-	-	14.4

10 Revision history

Table 9. Document revision history

Date	Revision	Changes
03-Jul-2006	13	Order codes updated and new template.
13-Nov-2006	14	Add part number LD2980ABU18TR.
06-Sep-2007	15	Add Table 1 on page 1.
14-Feb-2008	16	Modified: Table 1 on page 1.
11-Jul-2008	17	Modified: Table 1 on page 1.
06-Nov-2013	18	Document name changed from LD2980ABxx and LD2980Cxx to LD2980. Updated Table 1: Device summary, Table 5: Electrical characteristics for LD2980ABM, Table 6: Electrical characteristics for LD2980CM and Section 8: Package information. Added Section 9: Packaging information. Minor text changes in title, in features and description in cover page.
30-Aug-2017	19	Removed 5.0 V versions of device (updated Features, Table 1: Device summary, Table 5: Electrical characteristics for LD2980ABM, and Table 6: Electrical characteristics for LD2980C. Minor textual updates.
07-Dec-2017	20	Updated Table 1: Device summary on the cover page.
11-Nov-2019	21	Updated Figure 25: SOT23-5L reel mechanical drawing added Figure 26: SOT23-5L oriented tape outline .

IMPORTANT NOTICE – PLEASE READ CAREFULLY

STMicroelectronics NV and its subsidiaries (“ST”) reserve the right to make changes, corrections, enhancements, modifications, and improvements to ST products and/or to this document at any time without notice. Purchasers should obtain the latest relevant information on ST products before placing orders. ST products are sold pursuant to ST’s terms and conditions of sale in place at the time of order acknowledgement.

Purchasers are solely responsible for the choice, selection, and use of ST products and ST assumes no liability for application assistance or the design of Purchasers’ products.

No license, express or implied, to any intellectual property right is granted by ST herein.

Resale of ST products with provisions different from the information set forth herein shall void any warranty granted by ST for such product.

ST and the ST logo are trademarks of ST. For additional information about ST trademarks, please refer to www.st.com/trademarks. All other product or service names are the property of their respective owners.

Information in this document supersedes and replaces information previously supplied in any prior versions of this document.

© 2019 STMicroelectronics – All rights reserved

OUR CERTIFICATE

DiGi provide top-quality products and perfect service for customer worldwide through standardization, technological innovation and continuous improvement. DiGi through third-party certification, we strictly control the quality of products and services. Welcome your RFQ to

Email: Info@DiGi-Electronics.com



Tel: +00 852-30501935

RFQ Email: Info@DiGi-Electronics.com

DiGi is a global authorized distributor of electronic components.