

STCF06TBR Datasheet



<https://www.DiGi-Electronics.com>

DiGi Electronics Part Number	STCF06TBR-DG
Manufacturer	STMicroelectronics
Manufacturer Product Number	STCF06TBR
Description	IC LED DRV RGLTR I2C 25TFBGA
Detailed Description	LED Driver IC 1 Output DC DC Regulator Step-Down (Buck), Step-Up (Boost) I2C Dimming 1.5A (Flash) 25-TFBGA (3x3)

This model STCF06TBR is available at DiGi Electronics.

DiGi Electronics offers a global database of semiconductor and electronic component datasheets.

We welcome your inquiries regarding pricing, lead time, or other product-related questions.

 [Request a Quote](#)

 [Datasheet Search](#)



Tel: +00 852-30501935

RFQ Email: Info@DiGi-Electronics.com

DiGi is a global authorized distributor of electronic components.

Purchase and inquiry

Manufacturer Product Number:

STCF06TBR

Series:

-

Type:

DC DC Regulator

Internal Switch(s):

Yes

Voltage - Supply (Min):

2.7V

Voltage - Output:

2.5V ~ 5V

Frequency:

1.8MHz

Applications:

Camera Flash

Mounting Type:

Surface Mount

Supplier Device Package:

25-TFBGA (3x3)

Manufacturer:

STMicroelectronics

Product Status:

Obsolete

Topology:

Step-Down (Buck), Step-Up (Boost)

Number of Outputs:

1

Voltage - Supply (Max):

5.5V

Current - Output / Channel:

1.5A (Flash)

Dimming:

I2C

Operating Temperature:

-40°C ~ 85°C (TA)

Package / Case:

25-TFBGA

Base Product Number:

STCF06

Environmental & Export classification

RoHS Status:

ROHS3 Compliant

REACH Status:

REACH Unaffected

HTSUS:

8542.39.0001

Moisture Sensitivity Level (MSL):

3 (168 Hours)

ECCN:

EAR99



STCF06

1.5 A white LED driver with I²C interface

Features

- Buck-boost DC-DC converter
- Drives one power LED up to:
 - 1.5 A between 3.5 V to 5.5 V
 - 1.3 A between 3.0 V to 5.5 V
 - 1 A between 2.7 V to 5.5 V
- Efficiency up to 80%
- Output current control
- 1.8 MHz fixed frequency PWM
- Full I²C control
- Operational modes:
 - Shutdown mode
 - Ready mode + auxiliary red LED
 - Ready mode + NTC
 - Flash mode: up to 1.5 A
 - Torch mode: up to 370 mA
- Soft and hard triggering of flash
- Flash and torch dimming with 16 exponential values
- Dimmable red LED indicator auxiliary output
- Internally or externally timed flash operation
- Digitally programmable safety time-out in flash mode
- LED over temperature detection and protection with external NTC resistor
- Open and shorted LED failure detection and protection
- Chip over temperature detection and protection
- < 1 μ A shutdown current
- Package 3 x 3 mm TFBGA25



Applications

- Cell phones and smart phones
- Camera flashes/strobe
- PDAs and digital still cameras

Description

The STCF06 is a high efficiency power supply solution to drive a single flash LED in camera phones, PDAs and other battery powered devices. It is a buck-boost converter able to guarantee a proper LED current control over all possible conditions of battery voltage and LED forward voltage. The output current control ensures a good current regulation over the forward voltage spread characteristics of the flash LED. All the functions of the device are controlled through the I²C bus which helps to reduce logic pins on the package and to save PCB tracks on the board. Hard and soft-triggering of flash are both supported. The device includes many functions to protect the chip and the power LED, such as: soft start control, chip over temperature, open and shorted LED detection and protection.

Table 1. Device summary

Order code	Package	Packaging
STCF06TBR	TFBGA25 (3 x 3 mm)	3500 parts per reel

Contents

1	Description (continued)	5
2	Diagram	6
3	Pin configuration	7
4	Maximum ratings	8
5	Application	9
6	Electrical characteristics	11
7	Detailed description	13
7.1	Introduction	13
7.2	Buck-boost converter	13
7.3	Logic pin description	13
7.3.1	SCL, SDA pins	13
7.3.2	TRIG pin	13
7.3.3	ATN pin	13
7.3.4	ADD pin	14
7.3.5	TMSK pin	14
7.4	Power-on reset	14
7.5	Shutdown, shutdown with NTC	14
7.6	Ready mode	15
7.7	Single or multiple flash using external (microprocessor) temporization ..	15
7.8	External (microprocessor) temporization using TRIG_EN bit	15
7.9	Single flash using internal temporization	15
7.10	Multiple flash using internal temporization	16
8	I²C bus interface	17
8.1	Data validity	17
8.2	Start and stop conditions	17
8.3	Byte format	18

8.4	Acknowledge	18
8.5	Writing to a single register	19
8.6	Interface protocol	20
8.7	Writing to multiple registers with incremental addressing	20
8.8	Reading from a single register	21
8.9	Reading from multiple registers with incremental addressing	21
9	Description of internal registers	23
9.1	PWR_ON	23
9.2	TRIG_EN	23
9.3	TCH_ON	23
9.4	NTC_ON	24
9.5	FTIM_0~3	24
9.6	TDIM_0~3	24
9.7	FDIM_0~3	24
9.8	AUXI_0~3	25
9.9	AUXT_0~3	25
9.10	F_RUN	26
9.11	LED_F	26
9.12	NTC_W	27
9.13	NTC_H	27
9.14	OT_F	27
9.15	VOUTOK_N	27
10	Typical performance characteristics	29
11	Package mechanical data	31
12	Revision history	34

List of tables

Table 1.	Device summary	1
Table 2.	Pin description	8
Table 3.	Absolute maximum ratings	9
Table 4.	Thermal data	9
Table 5.	List of external components	10
Table 6.	Electrical characteristics	11
Table 7.	Address table	14
Table 8.	Interface protocol	19
Table 9.	I ² C register mapping function	23
Table 10.	Command register	23
Table 11.	Dimming register	24
Table 12.	Auxiliary register	25
Table 13.	Auxiliary LED dimming table	26
Table 14.	Torch mode and flash mode dimming registers settings	26
Table 15.	Status register	26
Table 16.	Status register details	28
Table 17.	Document revision history	34

List of figures

Figure 1.	Block diagram	7
Figure 2.	Pin connections (top view)	8
Figure 3.	Application schematic	10
Figure 4.	Data validity on the I ² C bus	17
Figure 5.	Timing diagram on I ² C bus	18
Figure 6.	Bit transfer	18
Figure 7.	Acknowledge on I ² C bus	19
Figure 8.	Writing to a single register	20
Figure 9.	Writing to multiple register with incremental addressing	21
Figure 10.	Reading from a single register	21
Figure 11.	Reading from multiple registers	22
Figure 12.	Flash and torch current vs. dimming value	25
Figure 13.	VOUTOK_N behavior	27
Figure 14.	Efficiency vs. V _{BAT} flash mode	29
Figure 15.	Efficiency vs. V _{BAT} , torch mode	29
Figure 16.	Maximum output current vs. V _{BAT}	29
Figure 17.	Flash current vs. temperature	29
Figure 18.	Input current vs. V _{BAT} (V _{LED} = 3.75 V)	29
Figure 19.	Input current vs. V _{BAT} (I _{LED} = 1 A)	29
Figure 20.	I _{LED} flash vs. FDIM	30
Figure 21.	I _{LED} torch vs. TDIM	30
Figure 22.	Flash time dimming steps	30

1 Description (continued)

In addition, a digital programmable time-out function protects the LED in case of a wrong command from the microcontroller. An optional external NTC resistor is supported to protect the LED against over heating.

In mobile phone applications, it is possible to reduce immediately the flash LED current during the signal transmission using the TMSK pin. This saves battery life and gives more priority to supply RF transmission instead of flash function.

Dedicated I²C commands allow to separately program the current intensity in flash and torch mode using exponential steps. An auxiliary output controls an optional red LED to be used as a recording indicator.

The device is packaged in 3 x 3 mm TFBGA25 with 1 mm height.

Obsolete Product(s) - Obsolete Product(s)

3 Pin configuration

Figure 2. Pin connections (top view)

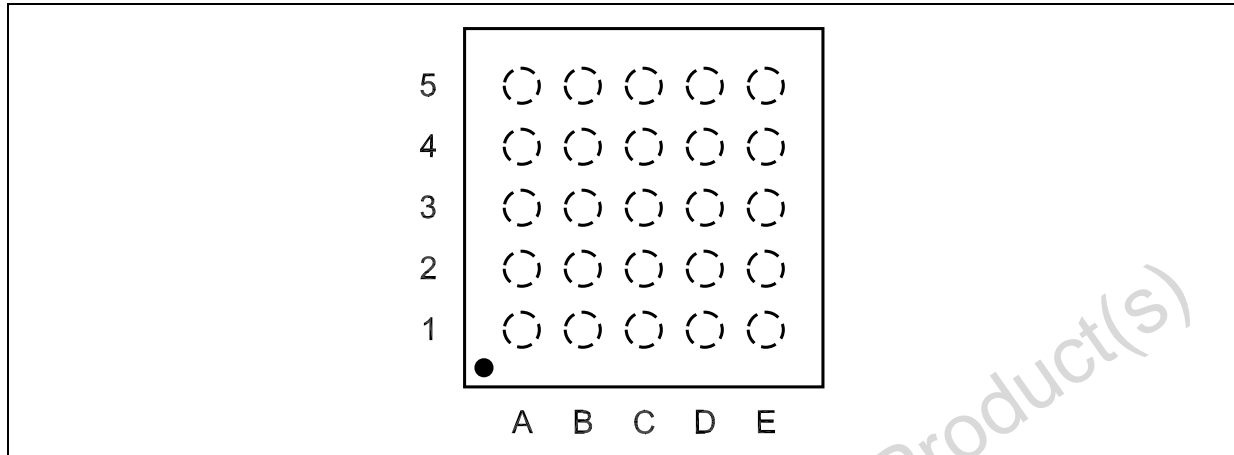

Table 2. Pin description

Pin n°	Symbol	Name and function
E1,D2	VLX2	Inductor connection
B3	RX	R_X resistor connection
D1,C2	VOUT	Output voltage
A4	NTC	NTC resistor connection
B5	FB1	Feedback pin [$I_{LED} * (R_{FL} + R_{TR})$]
A5	FB2	R_{TR} bypass
B4	FB2S	Feedback pin [$I_{LED} * R_{FL}$]
E2	GND	Signal ground
C5	TMSK	TX mask input
D5	AUXL	Auxiliary LED output
D4	ADD	I ² C address selection
A3	VBAT	Supply voltage
B1,C1	PVBAT	Power supply voltage
A2	VLX1A	Inductor connection
A1, B2	VLX1B	Inductor connection
E4	ATN	Attention (open drain output, active LOW)
E3	SDA	I ² C data
C3, D3	PGND	Power ground
E5	SCL	I ² C clock signal
C4	TRIG	Flash trigger input

4 Maximum ratings

Table 3. Absolute maximum ratings

Symbol	Parameter	Value	Unit
V _{BAT}	Signal supply voltage	-0.3 to 6	V
P _{V_{BAT}}	Power supply voltage	-0.3 to 6	V
VLX1A, VLX1B	Inductor connection 1	-0.3 to V _I +0.3	V
VLX2	Inductor connection 2	-0.3 to V _O +0.3	V
V _{OUT}	Output voltage	-0.3 to 6	V
AUXL	Auxiliary LED	-0.3 to V _{BAT} +0.3	V
FB1, FB2, FB2S	Feedback and sense voltage	-0.3 to 3	V
SCL, SDA, TRIG, ATN, ADD TMSK	Logic pin	-0.3 to V _{BAT} +0.3	V
R _X	Connection for reference resistor	-0.3 to 3	V
NTC	Connection for LED Temperature sensing	-0.3 to 3	V
ESD	Human body model	± 2	kV
P _{TOT}	Continuous power dissipation (at T _A = 70°C)	800	mW
T _{OP}	Operating junction temperature range	-40 to 85	°C
T _J	Junction temperature	-40 to 150	°C
T _{STG}	Storage temperature range	-65 to 150	°C

Note: Absolute maximum ratings are those values beyond which damage to the device may occur. Functional operation under these condition is not implied.

Table 4. Thermal data

Symbol	Parameter	Value	Unit
R _{thJA}	Thermal resistance junction-ambient	58	°C/W

5 Application

Figure 3. Application schematic

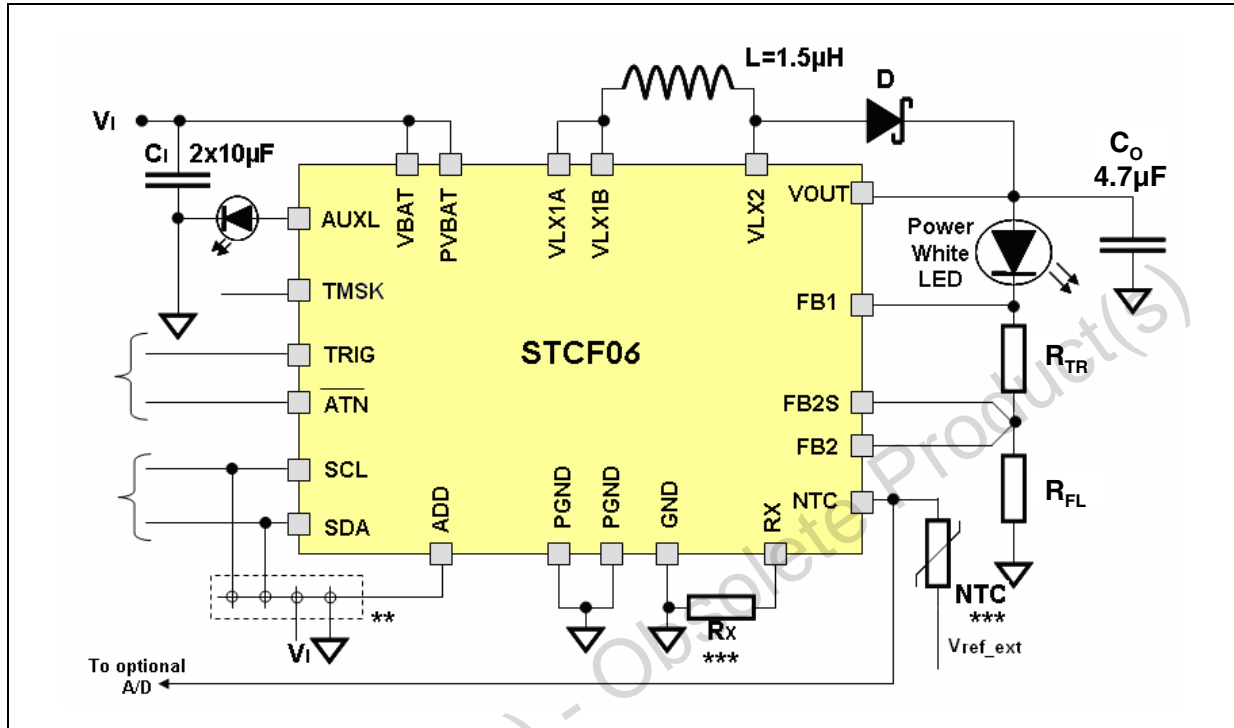

** : Connect to V_I , or GND or SDA or SCL to choose one of the 4 different I²C Slave Addresses.

*** : Optional components to support auxiliary functions. $V_{ref_ext} = 1.8\text{ V}$

Table 5. List of external components

Component	Manufacturer	Part number	Value	Size
C_I	TDK	C1608X5R0J106M	2 x 10 μF	0603
C_O	TDK	C1608X5R0J475M	4.7 μF	0603
L (max flash 1.5 A)	TDK	VLF4014A-1R51R8-1	1.5 μH	3.8x3.5x1.4 [mm]
NTC	Murata	NCP21WF104J03RA	100 k Ω	0805
R_{FL}	Tyco	RL73K1JR15JTD	0.15 Ω	0603
R_{TR}	Tyco	CRG0805F1R0	1 Ω	0805
R_X	Rohm	MCR01MZPJ15K	15 k Ω	0402
LED	Luxeon LED	LXCL-PWF1		
D	STMicroelectronics	STPS1L20MF (best performance)		3.8x1.9x0.85 [mm]
		BAT20J ⁽¹⁾ (smaller size)		2.7x1.35x1.13 [mm]

1. Due to the increased voltage drop, the output current performance is decreased.

Note: All of the above listed components refer to typical application. Operation of the STCF06 is not limited to the choice of these external components.

6 Electrical characteristics

$T_J = -40$ to 85 °C, $V_{BAT} = PV_{BAT} = 3.6$ V, $2 \times C_1 = 10$ μ F, $C_O = 4.7$ μ F, $L = 1.5$ μ H, $R_{FL} = 0.15$ Ω , $R_{TR} = 1$ Ω , $R_X = 15$ k Ω , typ. values are at $T_J = 25$ °C, unless otherwise specified.

Table 6. Electrical characteristics

Symbol	Parameter	Test condition	Min.	Typ.	Max.	Unit
V_I	Input operation supply voltage		2.7		5.5	V
V_{PW_ON} RESET	Power-ON reset threshold	V_I rising		2.3		V
I_O	Output current adjustment range I_{FLASH}	Flash mode for $V_I = 3.5$ V to 5.5 V	117		1500	mA
		Flash mode for $V_I = 3.0$ V to 3.3 V	117		1300	
		Flash mode for $V_I = 2.7$ V to 5.5 V	117		1000	
	Output current adjustment range I_{TORCH}	Torch mode $V_I = 2.7$ V to 5.5 V	29		370	
	Auxiliary LED output current adjustment range I_{AUXLED}	Ready mode, $V_I = 2.7$ V to 5.5 V	0	20		
V_O	Regulated voltage range		2.5		5.0	V
FB1	Feedback voltage	Torch mode	30		250	mV
FB2	Feedback voltage	Flash mode	30		250	mV
ΔI_O	Output current tolerance	Flash mode, $I_O = 160$ mV/ R_{FL}	-10		10	%
$R_{ON_}$	FB1-FB2 ON resistance	Torch mode, $I_O = 200$ mA		90		m Ω
I_Q	Quiescent current in SHUTDOWN mode			1		μ A
	Quiescent current in ready - mode			1.8		mA
f_s	Frequency	$V_I = 2.7$ V		1.8		MHz
η	Efficiency of the chip itself ⁽¹⁾	$V_I = 3.2$ to 4.2 V, Flash Mode, $I_O = 2200$ mA		80		%
	Efficiency of the whole application ⁽²⁾	$V_I = 3.2$ to 4.2 V, Flash Mode, $I_O = 2200$ mA, $V_O = V_{fLED_max} + V_{FB2} = 5.02$ V See the typical application schematic It is included losses of inductor and sensing resistor		70		
OVP	Output over voltage protection	$V_I = 5.5$ V, No Load	5.3			V
OV _{HYST}	Over voltage hysteresis	$V_I = 5.5$ V, No Load		0.2		V
OTP	Junction over temperature protection			140		°C
OT _{HYST}	Junction over temperature hysteresis			20		°C
V_{REF5}	NTC hot voltage threshold	Ready mode, $I_{NTC} = 2$ mA max		1.2		V

Electrical characteristics

STCF06

Table 6. Electrical characteristics (continued)

Symbol	Parameter	Test condition	Min.	Typ.	Max.	Unit
V_{REF4}	NTC warning voltage threshold	Ready mode, $I_{NTC} = 2\text{mA max}$		0.56		V
R_{ONT1}	RX-NTC switch ON resistance	Ready mode		25		Ω
NTC_{LEAK}	RX-NTC switch OFF leakage	Shutdown mode, $V_{NTC} = 2\text{ V}$ $V_{RX} = \text{GND}$			1	μA
V_{OL}	Output logic signal level low ATN	$I_{OL} = 10\text{ mA}$			0.2	V
I_{OZ}	Output logic leakage current ATN	$V_{OZ} = 3.3\text{ V}$			1	mA
V_{IL}	Input logic signal level SCL, SDA, TRIG, TMSK, ADD	$V_I = 2.7\text{ V to }5.5\text{ V}$	0		0.4	V
V_{IH}			1.4		3	
T_{ON}	LED current rise time $I_{LED} = 0\text{ to }I_{LED} = \text{max}$				2	ms

1. Calculated as $(V_O * I_{LED}) / (V_{IN} * I_{IN})$
2. Calculated as $(V_{LED} * I_{LED}) / (V_{IN} * I_{IN})$

7 Detailed description

7.1 Introduction

The STCF06 is a buck-boost converter, dedicated to power and control the current of a power white LED in a camera cell phone. The device operates at a typical constant switching frequency of 1.8 MHz. It regulates the LED current up to 1.5 A and supports LED with forward voltage ranging from 2.5 V to 5.0 V. The input voltage supply range from 2.7 V to 5.5 V allows operation from a single cell Lithium-Ion battery. The I²C bus is used to control the device operation and for diagnostic purposes. The current in torch mode is adjustable up to 370 mA. Flash mode current is adjustable up to 1500mA for an input voltage higher than 3.5 V, 1300 mA for an input voltage of 3.0 V at least and 1000 mA when the input voltage is 2.7 V. The Aux LED current can be adjusted from 0 to 20 mA. The device uses an external NTC resistor to sense the temperature of the white LED. These two last functions may not be needed in all applications, and in these cases the relevant external components can be omitted.

7.2 Buck-boost converter

The regulation of the PWM controller is done by sensing the current of the LED through external sensing resistors (R_{FL} and R_{TR} , see application schematic). Depending on the forward voltage of the flash LED, the device automatically can change the operation mode between buck (step down) and boost (step up) mode.

Three cases can occur: Boost region ($V_O > V_{BAT}$): this configuration is used in most of the cases, as the output voltage $V_O = V_{fLED} + I_{LED} \times R_{FL}$ is higher than V_{BAT} ; Buck region ($V_O < V_{BAT}$); Buck / Boost region ($V_O \sim V_{BAT}$).

7.3 Logic pin description

7.3.1 SCL, SDA pins

These are the standard clock and data pins as defined in the I²C bus specification. External pull-up is required according to I²C bus specifications. The recommended maximum voltage of these signals should be 3.0 V.

7.3.2 TRIG pin

This input pin is internally AND-ed with the TRIG_EN bit to generate the internal signal that activates the flash operation. This gives to the user the possibility to accurately control the flash duration using a dedicated pin, avoiding the I²C bus latencies (hard-triggering). No internal pull-up nor pull-down is provided.

7.3.3 ATN pin

This output pin (open-drain, active LOW) is provided to better manage the information transfer from the STCF06 to the microprocessor. Because of the limitations of a single master I²C bus configuration, the microprocessor should regularly poll the STCF06 to verify if certain operations have been completed, or to check diagnostic information. Alternatively,

the microprocessor can use the ATN pin to be advised that new data are available in the STAT_REG, thus avoiding continuous polling. Then the information can be read in the STAT_REG by a read operation via I²C that, besides, automatically resets the ATN pin. The STAT_REG bits affecting the ATN pin status are mapped in [Table 15](#). No internal pull-up is provided.

7.3.4 ADD pin

With this pin it is possible to select one of the 4 possible I²C slave addresses. No internal pull-up nor pull-down is provided. The pin has to be connected to either GND, V₁, SCL or SDA to select the desired I²C slave address (see [Table 7](#))

Table 7. Address table

ADD pin	A7	A6	A5	A4	A3	A2	A1	A0
GND	0	1	1	0	0	0	0	R/W
VBAT	0	1	1	0	0	0	1	R/W
SDA	0	1	1	0	0	1	0	R/W
SCL	0	1	1	0	0	1	1	R/W

7.3.5 TMSK pin

This pin can be used to implement the TX masking function. This function has effect only for flash current settings higher than 370 mA (bit FDIM=7hex). Under this condition, when this pin is pulled high by the microprocessor, the current flowing in the LED is forced at 370 mA typ. No internal pull-up or pull-down is provided; to be externally wired to GND if TX masking function is not used. The value corresponds to R_{FL} resistor 0.15 ohm.

7.4 Power-on reset

This mode is initiated by applying a supply voltage above the V_{PW_ON RESET} threshold value. An internal timing (~1 μs) defines the duration of this status. The logic blocks are powered, but the device doesn't respond to any input. The registers are reset to their default values, the ATN and SDA pins are in high-Z, and the I²C slave address is internally set by reading the ADD pin configuration. After the internally defined time has elapsed, the STCF06 automatically enters the Stand-by mode.

7.5 Shutdown, shutdown with NTC

In this mode only the I²C interface is alive, accepting I²C commands and register settings. The device enters this mode: automatically from power-on reset status; by resetting the PWR_ON bit from other operation modes. Power consumption is at the minimum (1 μA max) if NTC is not activated (NTC_ON=0). If PWR_ON and NTC_ON is set, the T1 is switched ON (see [Figure 1](#)), allowing the microprocessor to measure the LED temperature through its A/D converter.

7.6 Ready mode

In this mode all internal blocks are turned ON, but the DC-DC converter is disabled and the White LED is disconnected. The NTC circuit can be activated to monitor the temperature of the LED and I²C commands and register settings are allowed to be executed immediately. Only in this mode the auxiliary LED is operational and can be turned ON and set at the desired brightness using the AUX REGISTER. The device enters this mode: from Stand-by by setting the PWR_ON bit; from flash operation by resetting the TRIG pin or the TRIG_EN bit or automatically from flash operation when the time counter reaches zero; from torch operation by resetting the TCH_ON bit. The device automatically enters this mode also when an overload or an abnormal condition has been detected during flash or torch operation ([Table 16: Status register details](#)).

7.7 Single or multiple flash using external (microprocessor) temporization

To avoid the I²C bus time latency, it is recommended to use the dedicated TRIG pin to define the flash duration (hard-triggering). The TRIG_EN bit of CMD_REG should be set before starting each flash operation, because it could have been reset automatically in the previous flash operation. The flash duration is determined by the pulse length that drives the TRIG pin. As soon as the flash is activated, the system needs typically 1.2 ms to ramp up the output current on the Power LED. The internal time counter will time-out flash operation and keep the LED dissipated energy within safe limits in case of Software deadlock; FTIM register has to be set first, either in Stand-by or in ready mode. Multiple flashes are possible by strobing the TRIG pin. Time out counter will cumulate every flash on-time until the defined time out is reached unless it is reloaded by updating the CMD_REG. After a single or multiple flash operations are timed-out, the device automatically goes into Ready mode by resetting the TRIG_EN bit, and also resets the F_RUN bit. The ATN pin is pulled down to inform the microprocessor that the STAT_REG has been updated.

7.8 External (microprocessor) temporization using TRIG_EN bit

Even if it is possible, it is not recommended to use the TRIG_EN bit to start and stop the flash operation, because of I²C bus latencies: this would result in inaccurate flash timing. Nevertheless, if this operation mode is chosen, the TRIG pin has to be kept High (logic level or wired to V_{BAT}), leaving the whole flash control to the I²C bus. Also in this operation mode the Time Counter will Time-out flash operation and keep the energy dissipated by the LED within safe limits in case of SW deadlock.

7.9 Single flash using internal temporization

Flash triggering can be obtained either by TRIG pin (hard-triggering) or by I²C commands (soft-triggering). The first solution is recommended for an accurate start time, while the second is less accurate because of the I²C bus time latency. Stop time is defined by the STCF06 internal temporization and its accuracy is determined by the internal oscillator. For hard-triggering, it is necessary to set the TRIG_EN bit in advance. For soft-triggering, the TRIG pin has to be kept High (logic level or wired to V_{BAT}) and the flash can be started by setting the FTIM and the TRIG_EN through I²C (both are located in the CMD_REG). There is a delay time between the moment the flash is triggered and when it appears. This delay is

caused by the time necessary to charge up the output capacitor, which is around 1.2 ms depending on battery voltage and output current value. Once triggered, the flash operation will be stopped when the time counter reaches zero. As soon as the flash is finished, the F_RUN bit is reset, the ATN pin is pulled down for 11 μ s to inform the microprocessor that the STAT_REG has been updated and the device goes back to Ready mode. If it is necessary to make a flash longer than the internal timer allows or a continuous flash, then the FTIM must be reloaded through I²C bus every time, before the internal timer reaches zero. For example: To get a continuous flash, set FTIM to 1.5 s and every 1 s reload the CMD_REG.

7.10 Multiple flash using internal temporization

This operation has to be processed as a sequence of single flashes using internal temporization starting from hard or soft triggering. Since the TRIG_EN bit is reset at the end of each flash, it is necessary to reload the CMD_REG to start the next one.

8 I²C bus interface

Data transmission from the main microprocessor to STCF06 and vice versa takes place through the 2 I²C bus interface wires, consisting of the two lines SDA and SCL (pull-up resistors to a positive supply voltage must be externally connected). The recommended maximum voltage of these signals should be 3.0 V.

8.1 Data validity

As shown in [Figure 4](#), the data on the SDA line must be stable during the high period of the clock. The HIGH and LOW state of the data line can only change when the clock signal on the SCL line is LOW.

Figure 4. Data validity on the I²C bus

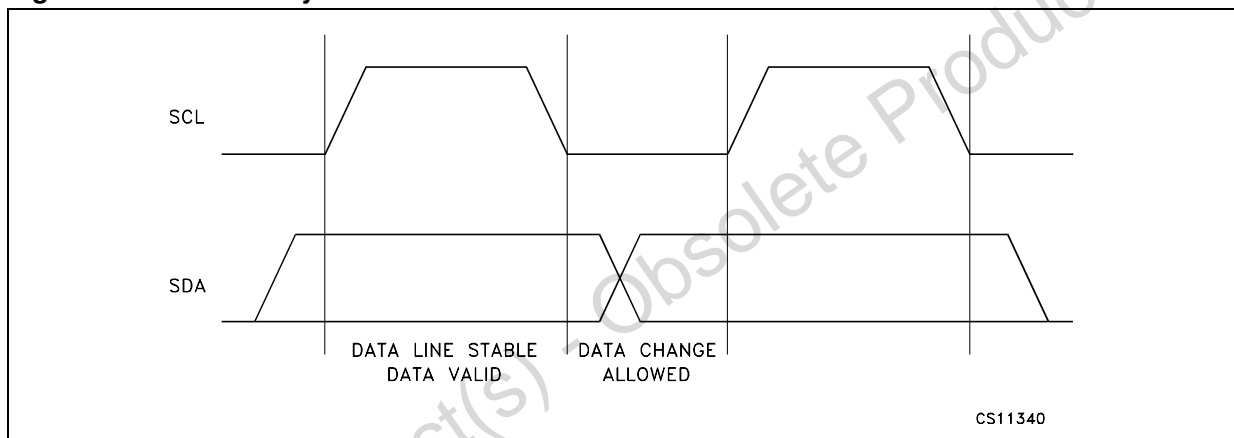

8.2 Start and stop conditions

Both DATA and CLOCK lines remain HIGH when the bus is not busy. As shown in [Figure 5](#) a start condition is a HIGH to LOW transition of the SDA line while SCL is HIGH. The stop condition is a LOW to HIGH transition of the SDA line while SCL is HIGH. A STOP condition must be sent before each START condition.

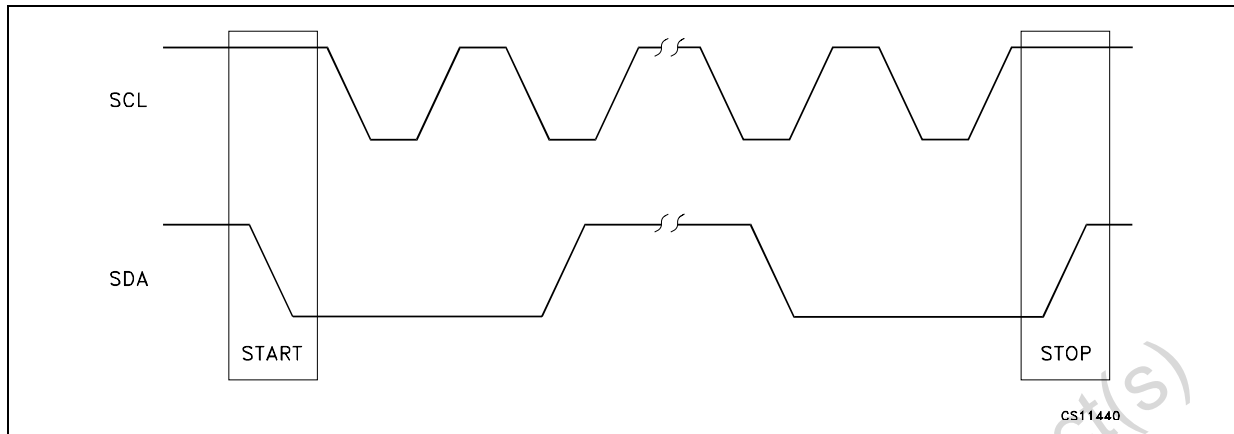
Figure 5. Timing diagram on I²C bus

8.3 Byte format

Every byte transferred to the SDA line must contain 8 bits. Each byte must be followed by an acknowledge bit. The MSB is transferred first. One data bit is transferred during each clock pulse. The data on the SDA line must remain stable during the HIGH period of the clock pulse. Any change in the SDA line at this time will be interpreted as a control signal.

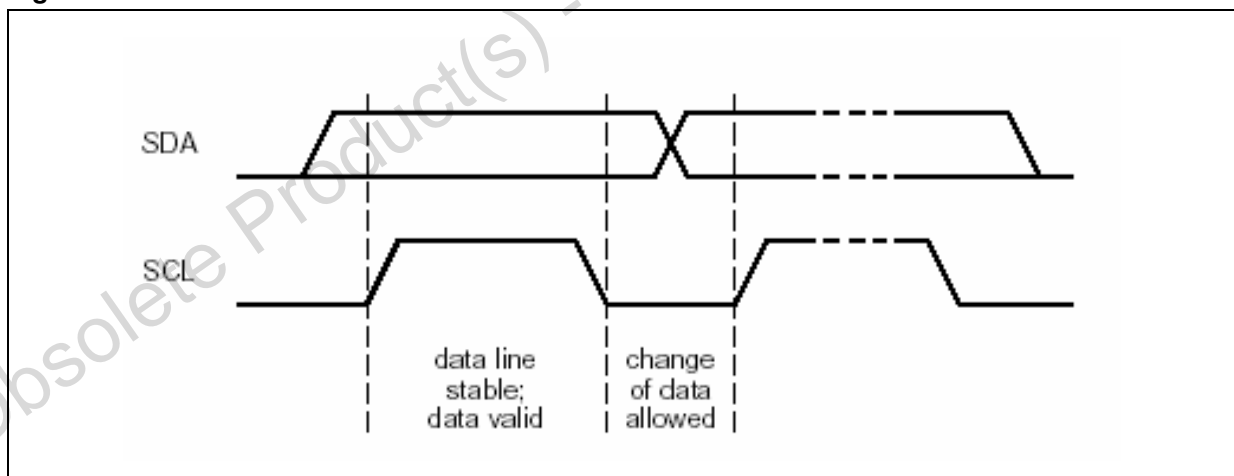
Figure 6. Bit transfer

8.4 Acknowledge

The master (microprocessor) puts a resistive HIGH level on the SDA line during the acknowledge clock pulse (see [Figure 7](#)). The peripheral (STCF06) that acknowledges has to pull-down (LOW) the SDA line during the acknowledge clock pulse, so that the SDA line is stable LOW during this clock pulse. The peripheral which has been addressed has to generate an acknowledge pulse after the reception of each byte, otherwise the SDA line remains at the HIGH level during the ninth clock pulse duration. In this case, the master transmitter can generate the STOP information in order to abort the transfer.

Figure 8. Writing to a single register

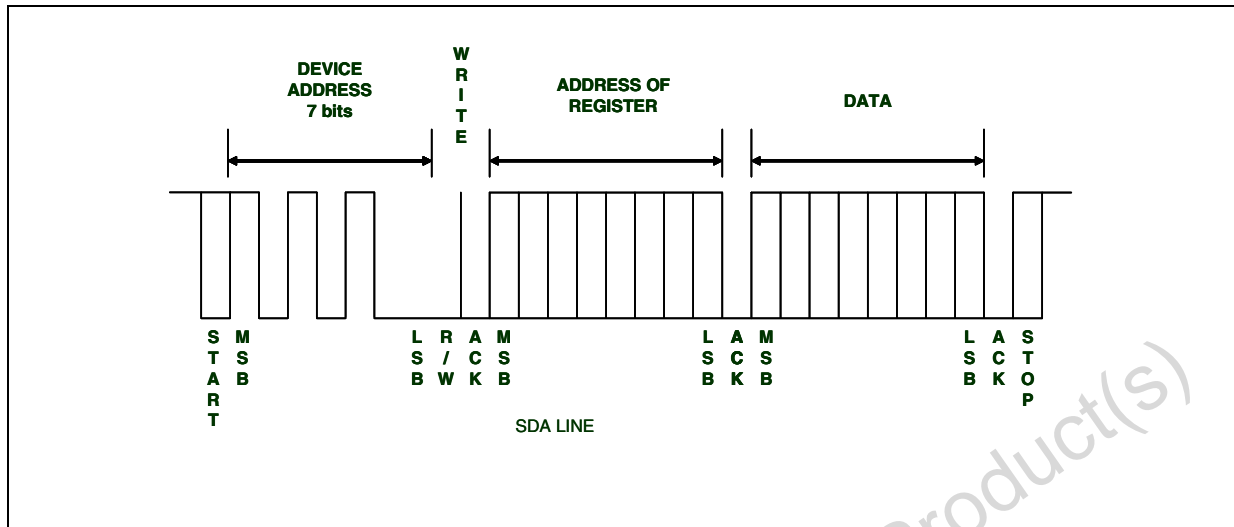

8.6 Interface protocol

The interface protocol is composed:

- A start condition (START)
- A Device address + R/W bit (read =1 / write =0)
- A Register address byte
- A sequence of data n^* (1 byte + acknowledge)
- A stop condition (STOP)

The Register address byte determines the first register in which the read or write operation takes place. When the read or write operation is finished, the register address is automatically increased.

8.7 Writing to multiple registers with incremental addressing

It would be unpractical to send several times the device address and the address of the register when writing to multiple registers. STCF06 supports writing to multiple registers with incremental addressing. When the data is written to a register, the address register is automatically increased, so the next data can be sent without sending the device address and the register address again. See [Figure 9](#) below.

Figure 9. Writing to multiple register with incremental addressing

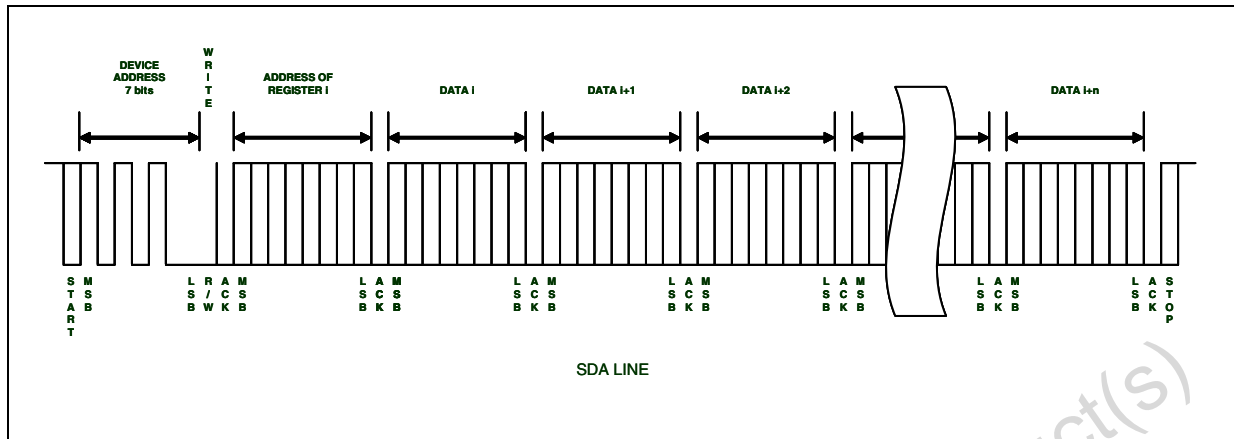

8.8 Reading from a single register

The reading operation starts with a START bit followed by the 7 bit device address of STCF06. The 8th bit is the R/W bit, which is 0 in this case. STCF06 confirms the receiving of the address + R/W bit by an acknowledge pulse. The address of the register which should be read is sent afterwards and confirmed again by an acknowledge pulse of STCF06 again. Then the master generates a START bit again and sends the device address followed by the R/W bit, which is 1 now. STCF06 confirms the receiving of the address + R/W bit by an acknowledge pulse and starts to send the data to the master. No acknowledge pulse from the master is required after receiving the data. Then the master generates a STOP bit to terminate the communication. See [Figure 10](#)

Figure 10. Reading from a single register

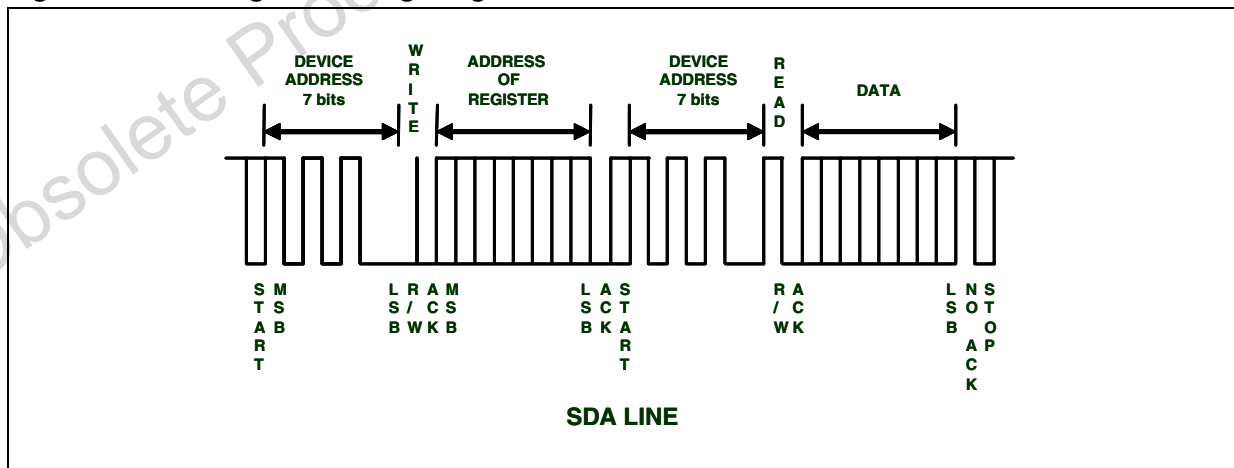

8.9 Reading from multiple registers with incremental addressing

Reading from multiple registers starts in the same way like reading from a single register. As soon as the first register is read, the register address is automatically increased. If the master generates an acknowledge pulse after receiving the data from the first register, then

reading of the next register can start immediately without sending the device address and the register address again. The last acknowledge pulse before the STOP bit is not required. See the [Figure 11](#).

Figure 11. Reading from multiple registers

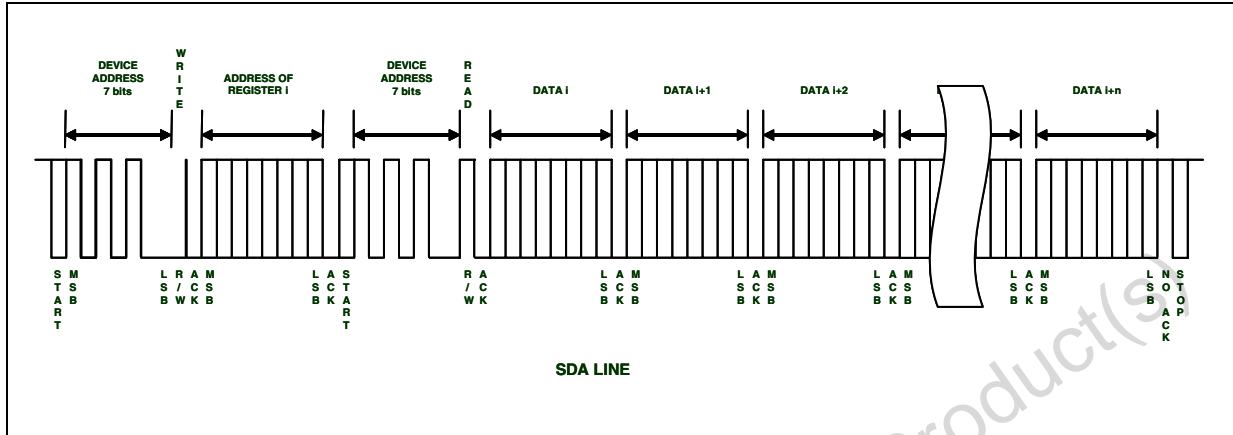

9 Description of internal registers

Table 9. I²C register mapping function

Register name	SUB ADDRESS (hex)	Operation
CMD_REG	00	R / W
DIM_REG	01	R / W
AUX_REG	02	R / W
STAT_REG	03	R only

Table 10. Command register

CMD_REG (write mode)	MSB							LSB
SUB ADD=00	PWR_ON	TRIG_EN	TCH_ON	NTC_ON	FTIM_3	FTIM_2	FTIM_1	FTIM_0
Power-ON RESET Value	0	0	0	0	0	0	0	0

9.1 PWR_ON

When set, it activates all analog and power internal blocks including the NTC supporting circuit, and the device is ready to operate (ready mode). As long as PWR_ON=0, only the I²C interface is active, minimizing Stand-by Mode power consumption.

9.2 TRIG_EN

This bit is AND-ed with the TRIG pin to generate the internal signal FL_ON that activates flash mode. By this way, both soft-triggering and hard-triggering of the flash are made possible. If soft-triggering (through I²C) is chosen, the TRIG pin is not used and must be kept HIGH (VI). If hard-triggering is chosen, then the TRIG pin has to be connected to a microprocessor I/O devoted to flash timing control, and the TRIG_EN bit must be set in advance. Both triggering modes can benefit of the internal flash time counter, that uses the TRIG_EN bit and can work either as a safety shut-down timer or as a flash duration timer. flash mode can start only if PWR_ON=1. LED current is controlled by the value set by the FDIM_0~3 of the DIM_REG.

9.3 TCH_ON

When set from Ready mode, the STCF06 enters the torch mode. The LED current is controlled by the value set by the TDIM_0~3 of the DIM_REG.

9.4 NTC_ON

In ready mode, the comparators that monitor the LED temperature are activated if NTC_ON bit is set. NTC-related blocks are always active regardless of this bit in torch mode and flash mode.

9.5 FTIM_0~3

This 4-bits register defines the maximum flash duration. It is intended to limit the energy dissipated by the LED to a maximum safe value or to leave to the STCF06 the control of the flash duration during normal operation. Values from 0~15 correspond to 0 ~ 1.5 s (100 ms steps). The timing accuracy is related to the internal oscillator frequency that clocks the flash time counter (+/- 20 %). Entering flash mode (either by soft or hard triggering) activates the flash time counter, which begins counting down from the value loaded in the F_TIM register. When the counter reaches zero, flash mode is stopped by resetting TRIG_EN bit, and simultaneously the ATN pin is set to true (LOW) to alert the microprocessor that the maximum time has been reached. FTIM value remains unaltered at the end of the count.

Table 11. Dimming register

DIM_REG (write mode)	MSB							LSB
SUB ADD=01	TDIM_3	TDIM_2	TDIM_1	TDIM_0	FDIM_3	FDIM_2	FDIM_1	FDIM_0
Power-ON, SHUTDOWN MODE RESET Value	0	0	0	0	0	0	0	0

9.6 TDIM_0~3

These 4 bits define the LED current in torch mode with 16 values fitting an exponential law. Max torch current value is 25% of max flash current. ([Figure 12](#))

9.7 FDIM_0~3

These 4 bits define the LED current in flash mode with 16 values fitting an exponential law. The Max value of the current is set by the external resistors R_{FL} and R_{TR} . ([Figure 12](#))

Figure 12. Flash and torch current vs. dimming value

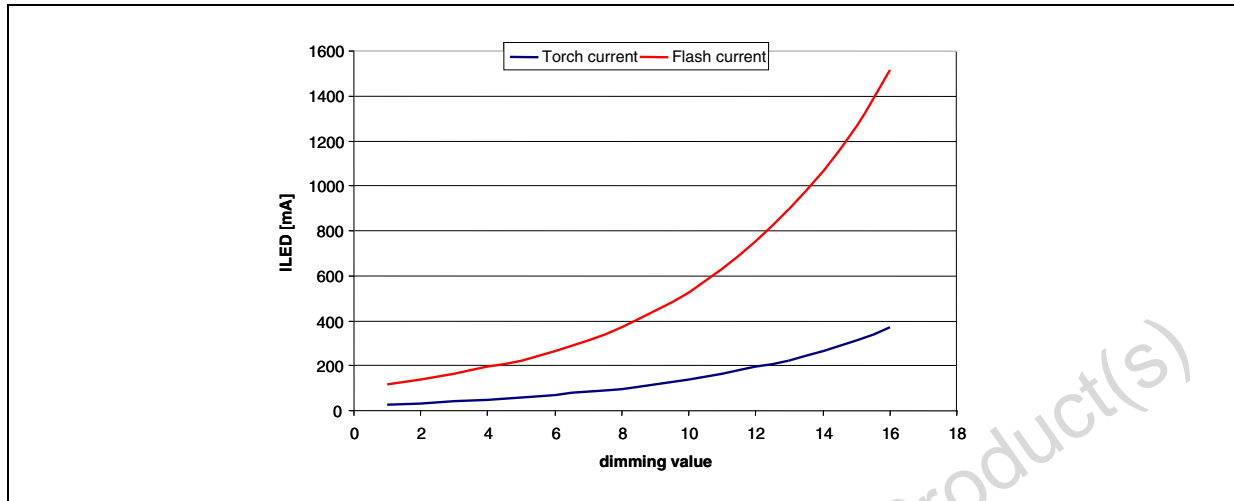

Note: LED current values refer to $R_{FL} = 0.15 \Omega$, $R_{TR} = 1.0 \Omega$

Table 12. Auxiliary register

AUX_REG (write mode)	MSB							LSB
SUB ADD=02	AUXI_3	AUXI_2	AUXI_1	AUXI_0	AUXT_3	AUXT_2	AUXT_1	AUXT_0
Power-ON, SHUTDOWN MODE RESET Value	0	0	0	0	0	0	0	0

9.8 AUXI_0~3

This 4 bits register defines the AUX LED current from 0 to 20 mA. See AUX LED Dimming Table for reference. Loading any value between 1 and 15 also starts the AUX LED current source timer, if enabled. The AUX LED current source is active only in Ready mode, and is deactivated in any other mode.

9.9 AUXT_0~3

This 4 bit register controls the timer that defines the ON-time of the AUX LED current source. ON-time starts when the AUXI register is loaded with any value other than zero, and stops after the time defined in the AUXT register. Values from 1 to 14 of the AUXT register correspond to an ON-time of the AUX LED ranging from 100 to 1400 ms in 100 ms steps. The value 15 puts the AUX LED to the continuous light mode. The activation/deactivation of the AUX LED current source is controlled using only the AUXI register.

9.12 NTC_W

This bit is set HIGH by the STCF06 and the ATN pin is pulled down, when the voltage seen on the pin R_X exceeds $V_{REF4} = 0.56$ V. This threshold corresponds to a warning temperature value at the LED measured by the NTC. The device is still operating, but a warning is sent to the microprocessor. This bit is reset by the STCF06 following a read operation of the STAT_REG.

9.13 NTC_H

This bit is set HIGH by the STCF06 and the ATN pin is pulled down, when the voltage seen on the pin R_X exceeds V_{REF5} . This threshold (1.2 V) corresponds to an excess temperature value at the LED measured by the NTC. The device is put in Ready mode to avoid damaging the LED. This bit is reset by the STCF06 following a read operation of the STAT_REG.

9.14 OT_F

This bit is set HIGH by the STCF06 and the ATN pin is pulled down, when the chip over-temperature protection (~ 140 °C) has put the device in Ready mode. This bit is reset by the STCF06 following a read operation of the STAT_REG.

9.15 VOUTOK_N

This bit is set by the STCF06. It is used to protect the device, if the output is shorted. The VOUTOK_N bit is set to HIGH at the start-up. Then a current generator of 20 mA charges the output capacitor for 360 μ s typ. and it detects when the output capacitor reaches 100 mV. If this threshold is reached the bit is set to LOW. If the output is shorted to ground or the LED is shorted, this threshold is never reached: the bit stays HIGH, ATN pin is pulled down and the device will not start. This bit is reset following a read operation of the STAT_REG.

Figure 13. VOUTOK_N behavior

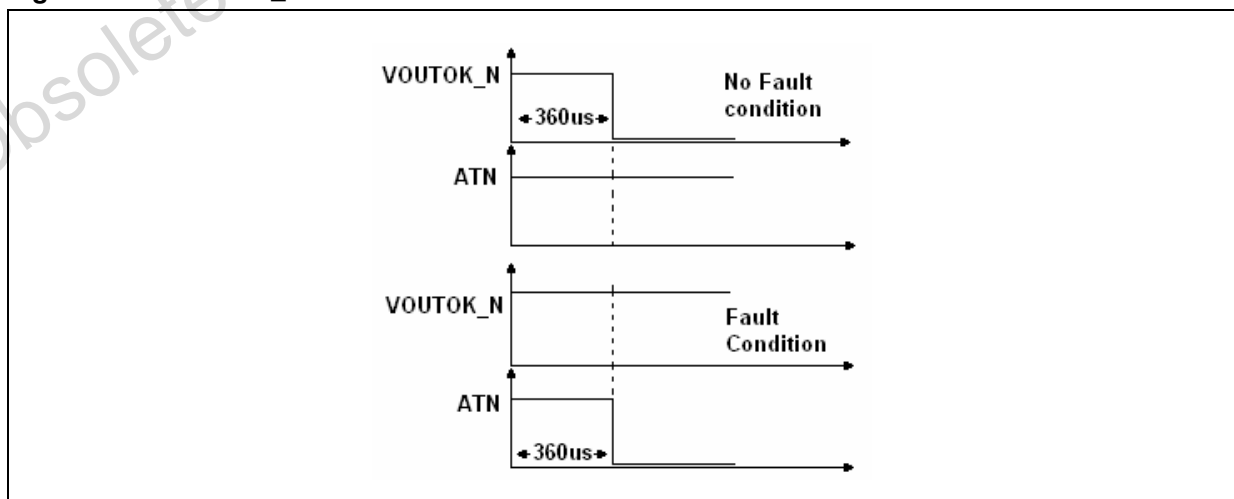

Table 16. Status register details

Bit Name	F_RUN (STAT_REG)	LED_F (STAT_REG)	NTC_W (STAT_REG)	NTC_H (STAT_REG)	OT_F (STAT_REG)	VOUTOK_N (STAT_REG)
Default value	0	0	0	0	0	0
Latched ⁽¹⁾	NO	YES	YES	YES	YES	YES
Forces Ready mode when set	NO	YES	NO	YES	YES	YES
Sets ATN LOW when set	NO	YES	YES	YES	YES	YES

1. YES means that the bit is set by internal signals and is reset to default by an I²C read operation of STAT_REG. NO means that the bit is set and reset by internal signals in real-time.

10 Typical performance characteristics

Figure 14. Efficiency vs. V_{BAT} flash mode

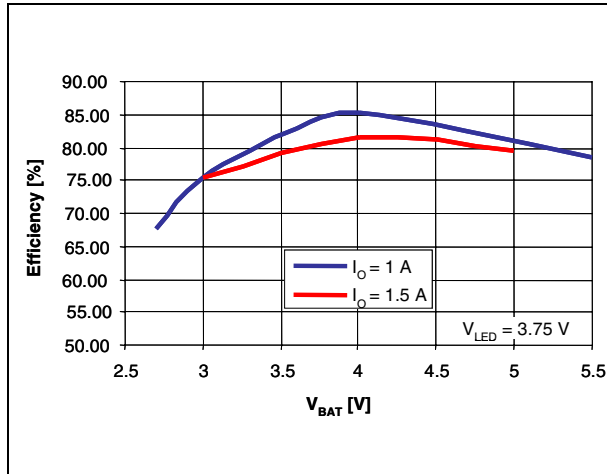

Figure 15. Efficiency vs. V_{BAT} , torch mode

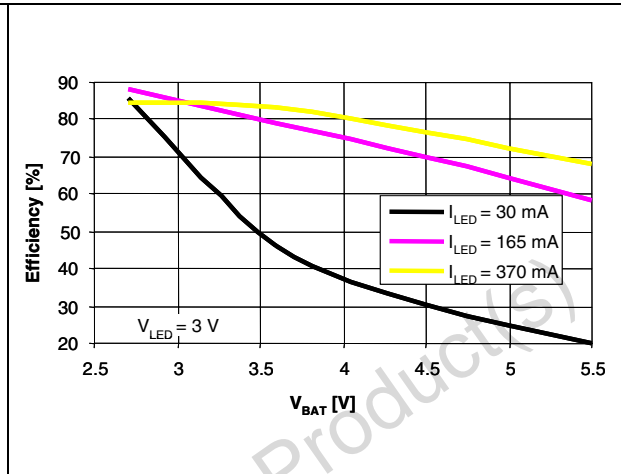

Figure 16. Maximum output current vs. V_{BAT}

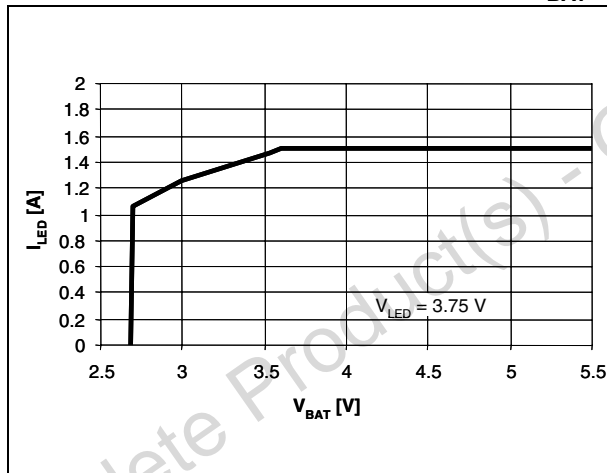

Figure 17. Flash current vs. temperature

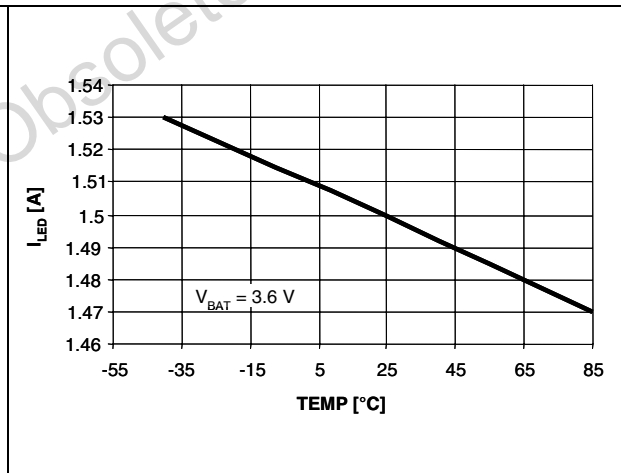

Figure 18. Input current vs. V_{BAT} ($V_{LED} = 3.75$ V)

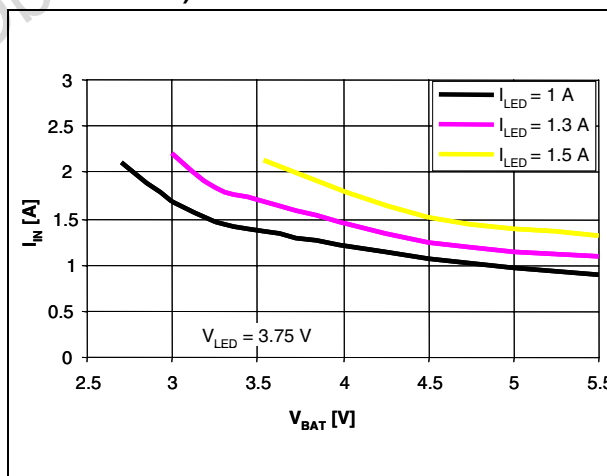

Figure 19. Input current vs. V_{BAT} ($I_{LED} = 1$ A)

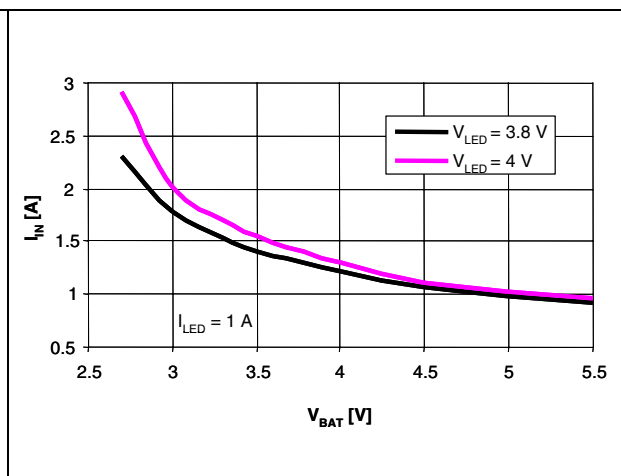

Figure 20. I_{LED} flash vs. FDIMFigure 21. I_{LED} torch vs. TDIM

Figure 22. Flash time dimming steps



11 Package mechanical data

In order to meet environmental requirements, ST offers these devices in different grades of ECOPACK[®] packages, depending on their level of environmental compliance. ECOPACK[®] specifications, grade definitions and product status are available at: www.st.com. ECOPACK[®] is an ST trademark.

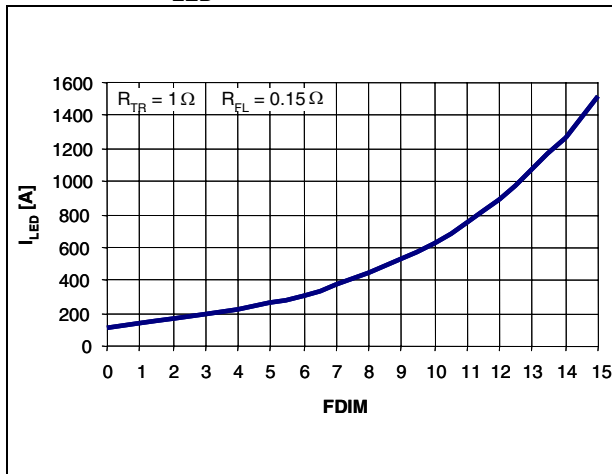
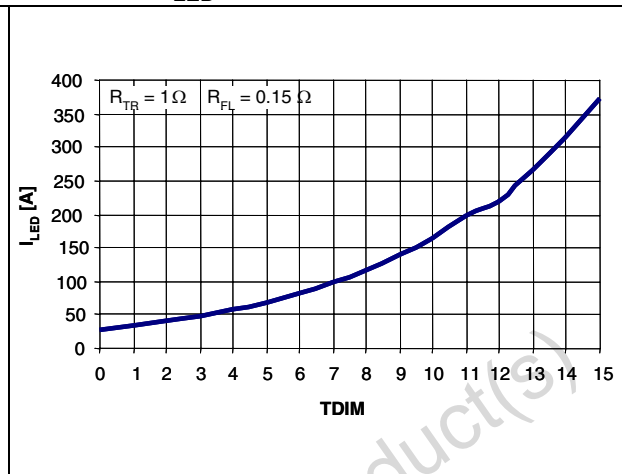
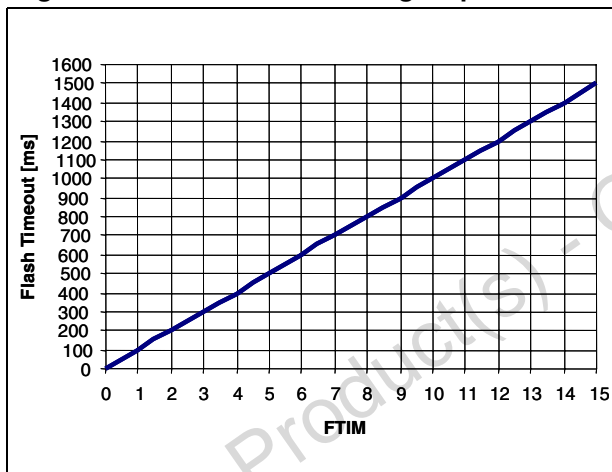
Obsolete Product(s) - Obsolete Product(s)

TFBGA25 mechanical data

Dim.	mm.			mils.		
	Min.	Typ.	Max.	Min.	Typ.	Max.
A	1.0	1.1	1.16	39.4	43.3	45.7
A1			0.25			9.8
A2	0.78		0.86	30.7		33.9
b	0.25	0.30	0.35	9.8	11.8	13.8
D	2.9	3.0	3.1	114.2	118.1	122.0
D1		2			78.8	
E	2.9	3.0	3.1	114.2	118.1	122.0
E1		2			78.8	
e		0.5			19.7	
SE		0.25			9.8	

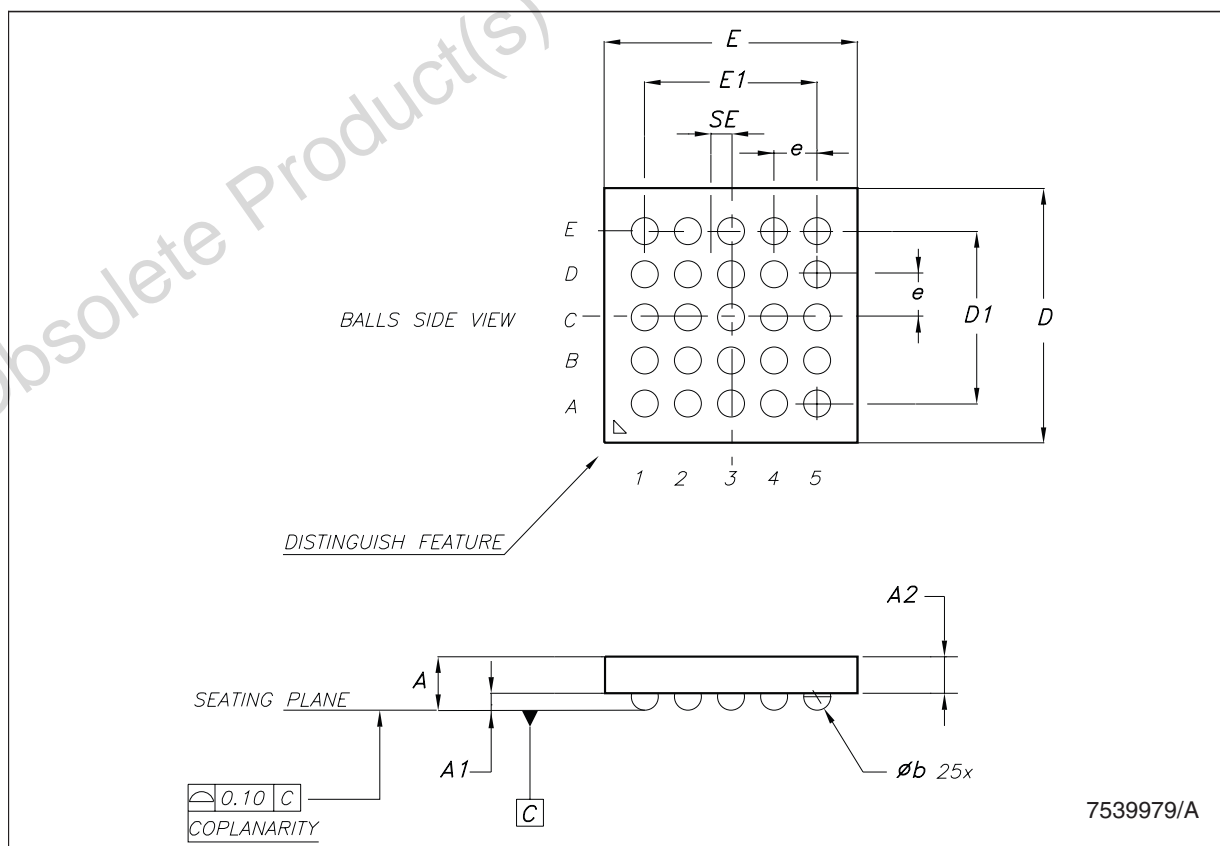

Tape & reel TFBGA25 mechanical data

Dim.	mm.			inch.		
	Min.	Typ.	Max.	Min.	Typ.	Max.
A			330			12.992
C	12.8		13.2	0.504		0.519
D	20.2			0.795		
N	60			2.362		
T			14.4			0.567
Ao		3.3			0.130	
Bo		3.3			0.130	
Ko		1.60			0.063	
Po	3.9		4.1	0.153		0.161
P	7.9		8.1	0.311		0.319

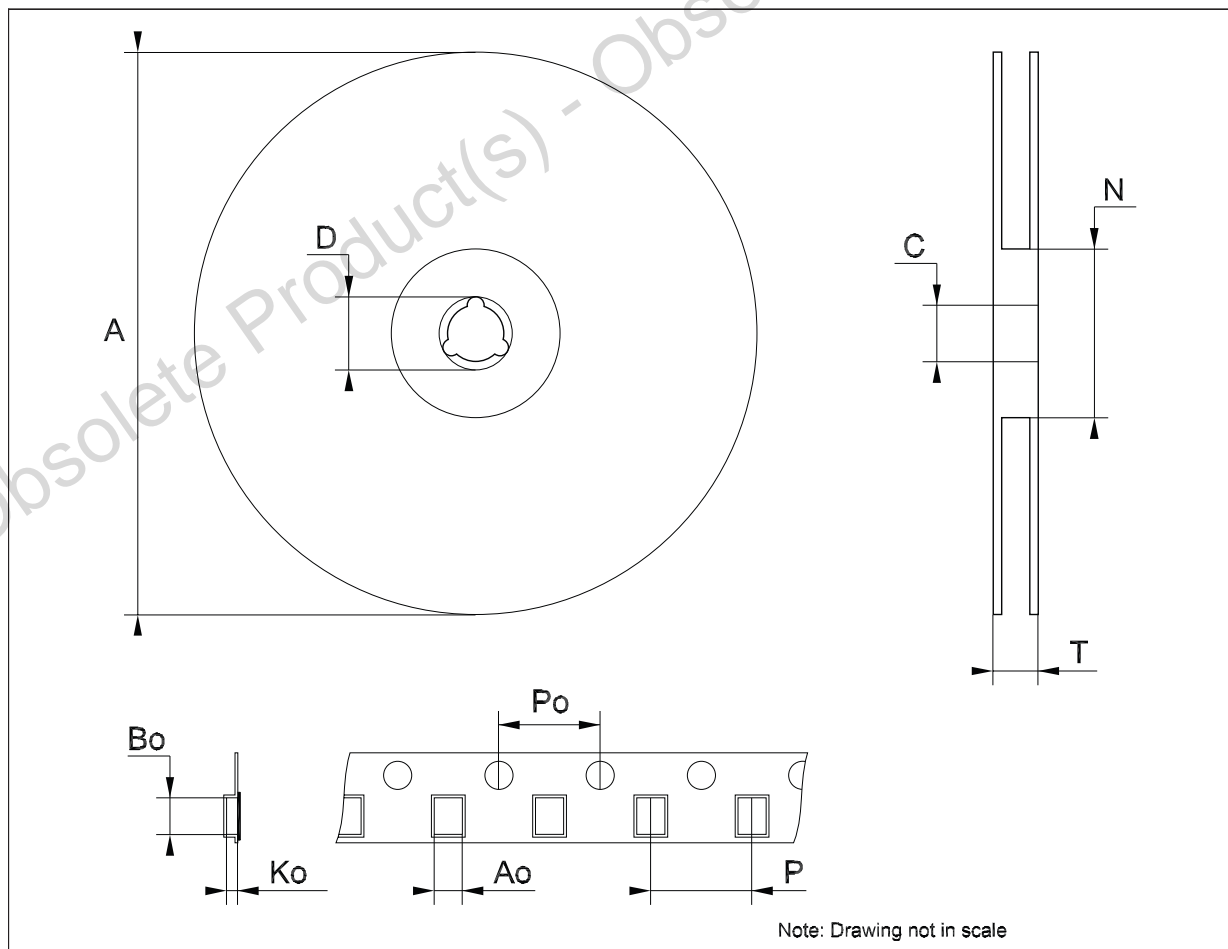

12 Revision history

Table 17. Document revision history

Date	Revision	Changes
18-Mar-2008	1	First release
09-May-2008	2	Modified: packaging, Table 1 on page 1
29-Jul-2010	3	Modified Figure 2 on page 8

Obsolete Product(s) - Obsolete Product(s)

STCF06

Please Read Carefully:

Information in this document is provided solely in connection with ST products. STMicroelectronics NV and its subsidiaries ("ST") reserve the right to make changes, corrections, modifications or improvements, to this document, and the products and services described herein at any time, without notice.

All ST products are sold pursuant to ST's terms and conditions of sale.

Purchasers are solely responsible for the choice, selection and use of the ST products and services described herein, and ST assumes no liability whatsoever relating to the choice, selection or use of the ST products and services described herein.

No license, express or implied, by estoppel or otherwise, to any intellectual property rights is granted under this document. If any part of this document refers to any third party products or services it shall not be deemed a license grant by ST for the use of such third party products or services, or any intellectual property contained therein or considered as a warranty covering the use in any manner whatsoever of such third party products or services or any intellectual property contained therein.

UNLESS OTHERWISE SET FORTH IN ST'S TERMS AND CONDITIONS OF SALE ST DISCLAIMS ANY EXPRESS OR IMPLIED WARRANTY WITH RESPECT TO THE USE AND/OR SALE OF ST PRODUCTS INCLUDING WITHOUT LIMITATION IMPLIED WARRANTIES OF MERCHANTABILITY, FITNESS FOR A PARTICULAR PURPOSE (AND THEIR EQUIVALENTS UNDER THE LAWS OF ANY JURISDICTION), OR INFRINGEMENT OF ANY PATENT, COPYRIGHT OR OTHER INTELLECTUAL PROPERTY RIGHT.

UNLESS EXPRESSLY APPROVED IN WRITING BY AN AUTHORIZED ST REPRESENTATIVE, ST PRODUCTS ARE NOT RECOMMENDED, AUTHORIZED OR WARRANTED FOR USE IN MILITARY, AIR CRAFT, SPACE, LIFE SAVING, OR LIFE SUSTAINING APPLICATIONS, NOR IN PRODUCTS OR SYSTEMS WHERE FAILURE OR MALFUNCTION MAY RESULT IN PERSONAL INJURY, DEATH, OR SEVERE PROPERTY OR ENVIRONMENTAL DAMAGE. ST PRODUCTS WHICH ARE NOT SPECIFIED AS "AUTOMOTIVE GRADE" MAY ONLY BE USED IN AUTOMOTIVE APPLICATIONS AT USER'S OWN RISK.

Resale of ST products with provisions different from the statements and/or technical features set forth in this document shall immediately void any warranty granted by ST for the ST product or service described herein and shall not create or extend in any manner whatsoever, any liability of ST.

ST and the ST logo are trademarks or registered trademarks of ST in various countries.

Information in this document supersedes and replaces all information previously supplied.

The ST logo is a registered trademark of STMicroelectronics. All other names are the property of their respective owners.

© 2010 STMicroelectronics - All rights reserved

STMicroelectronics group of companies

Australia - Belgium - Brazil - Canada - China - Czech Republic - Finland - France - Germany - Hong Kong - India - Israel - Italy - Japan - Malaysia - Malta - Morocco - Philippines - Singapore - Spain - Sweden - Switzerland - United Kingdom - United States of America

www.st.com



OUR CERTIFICATE

DiGi provide top-quality products and perfect service for customer worldwide through standardization, technological innovation and continuous improvement. DiGi through third-party certification, we stricly control the quality of products and services. Welcome your RFQ to

Email: Info@DiGi-Electronics.com



Tel: +00 852-30501935

RFQ Email: Info@DiGi-Electronics.com

DiGi is a global authorized distributor of electronic components.