

STPS50U100CT Datasheet

www.digi-electronics.com

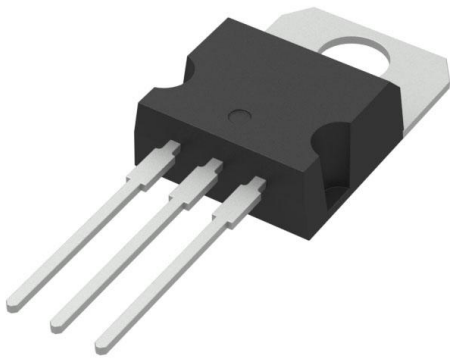

<https://www.DiGi-Electronics.com>

DiGi Electronics Part Number	STPS50U100CT-DG
Manufacturer	STMicroelectronics
Manufacturer Product Number	STPS50U100CT
Description	DIODE ARR SCHOTT 100V 25A TO220
Detailed Description	Diode Array 1 Pair Common Cathode 100 V 25A Through Hole TO-220-3

This model STPS50U100CT is available at DiGi Electronics.

DiGi Electronics offers a global database of semiconductor and electronic component datasheets.

We welcome your inquiries regarding pricing, lead time, or other product-related questions.

 [Request a Quote](#)

 [Datasheet Search](#)



Tel: +00 852-30501935

RFQ Email: Info@DiGi-Electronics.com

DiGi is a global authorized distributor of electronic components.

Purchase and inquiry

Manufacturer Product Number:

STPS50U100CT

Series:

-

Diode Configuration:

1 Pair Common Cathode

Voltage - DC Reverse (Vr) (Max):

100 V

Voltage - Forward (Vf) (Max) @ If:

730 mV @ 25 A

Current - Reverse Leakage @ Vr:

200 μ A @ 100 V

Mounting Type:

Through Hole

Supplier Device Package:

TO-220

Manufacturer:

STMicroelectronics

Product Status:

Obsolete

Technology:

Schottky

Current - Average Rectified (Io) (per Diode):

25A

Speed:

Fast Recovery \leq 500ns, > 200mA (Io)

Operating Temperature - Junction:

150°C (Max)

Package / Case:

TO-220-3

Base Product Number:

STPS50

Environmental & Export classification

RoHS Status:

ROHS3 Compliant

REACH Status:

REACH Unaffected

HTSUS:

8541.10.0080

Moisture Sensitivity Level (MSL):

1 (Unlimited)

ECCN:

EAR99



STPS50U100C

ULVF™ power Schottky rectifier

Features

- ultralow forward voltage drop
- high current capability
- high frequency operation

Description

The STPS50U100C is a dual power Schottky diode rectifier, suited for high frequency switch mode power supplies.

Featuring an ultralow forward voltage (ULVF) drop, this device, packaged in TO-220AB and I²PAK, is intended to be used in notebook, game station and desktop adaptors as well as server SMPS. It has been especially designed to help power supply manufacturers meet the recently introduced worldwide efficiency standards.

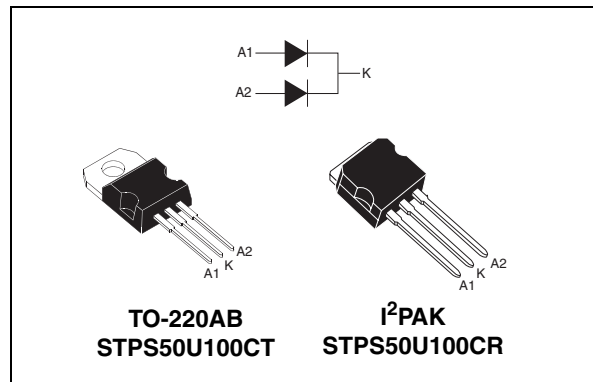

Table 1. Device summary

Symbol	Value
$I_{F(AV)}$	2 x 25 A
V_{RRM}	100 V
$V_F(\text{typ})$ (25 A @ 125 °C)	0.64 V
$T_j(\text{max})$	150 °C

TM: ULVF is a trademark of STMicroelectronics

1 Characteristics

Table 2. Absolute ratings (limiting values per diode at 25 °C, unless otherwise specified)

Symbol	Parameter		Value	Unit	
V _R RM	Repetitive peak reverse voltage		100	V	
I _F (RMS)	Forward rms current		50	A	
I _F (AV)	Average forward current, δ = 0.5	T _C = 120 °C	Per diode	25	A
		T _C = 105 °C	Per device	50	
I _F SM	Surge non repetitive forward current	t _p = 10 ms, half sine-wave	250	A	
T _{stg}	Storage temperature range		-65 to + 150	°C	
T _j	Maximum operating junction temperature ⁽¹⁾		150	°C	

1. $\frac{dP_{tot}}{dT_j} < \frac{1}{R_{th(j-a)}}$ condition to avoid thermal runaway for a diode on its own heatsink

Table 3. Thermal resistance

Symbol	Parameter		Value	Unit
R _{th(j-c)}	Junction to case	Per diode	1.3	°C/W
		Per device	0.9	
R _{th(c)}	Coupling		0.45	°C/W

When the diodes 1 and 2 are used simultaneously:

$$\Delta T_j(\text{diode 1}) = P(\text{diode1}) \times R_{th(j-c)}(\text{Per diode}) + P(\text{diode2}) \times R_{th(c)}$$

Table 4. Static electrical characteristics

Symbol	Parameter	Tests conditions	Min.	Typ.	Max.	Unit	
I _R	Reverse leakage current	T _j = 25 °C	V _R = 70 V	-	15	-	μA
		T _j = 125 °C		-	10	-	mA
		T _j = 25 °C	V _R = V _R RM	-	30	200	μA
		T _j = 125 °C		-	15	40	mA
V _F	Forward voltage drop	T _j = 25 °C	I _F = 5 A	-	0.48	-	V
		T _j = 125 °C		-	0.38	-	
		T _j = 25 °C	I _F = 15 A	-	0.58	-	
		T _j = 125 °C		-	0.54	-	
		T _j = 25 °C	I _F = 25 A	-	0.67	0.73	
		T _j = 125 °C		-	0.64	0.7	

To evaluate the conduction losses use the following equation: $P = 0.475 \times I_{F(AV)} + 0.009 I_{F(RMS)}^2$

Figure 1. Average forward power dissipation versus average forward current (per diode)

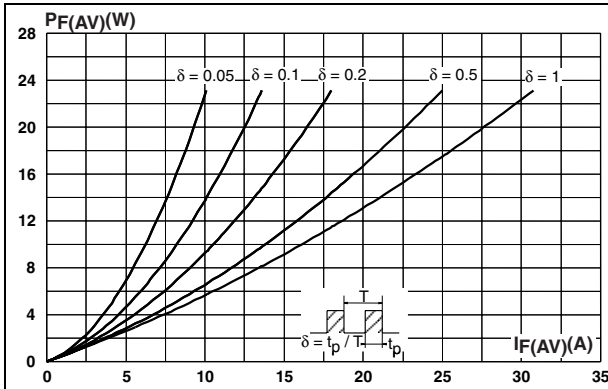

Figure 2. Non repetitive surge peak forward current versus overload duration (maximum values, per diode)

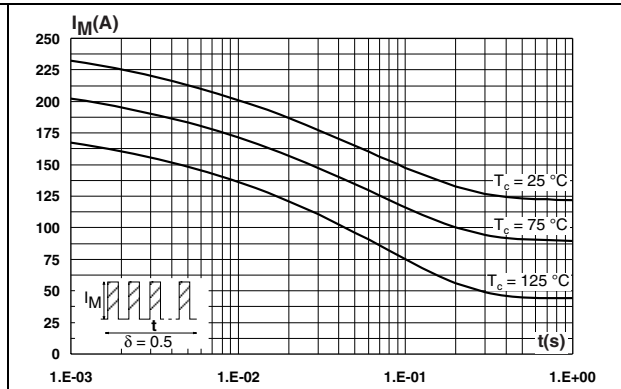

Figure 3. Reverse leakage current versus reverse voltage applied (typical values, per diode)

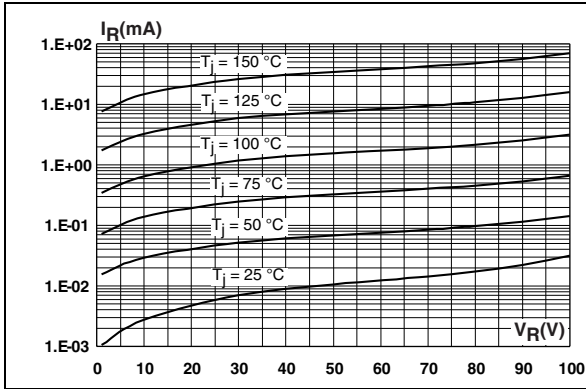

Figure 4. Average forward current versus ambient temperature (delta = 0.5, per diode)

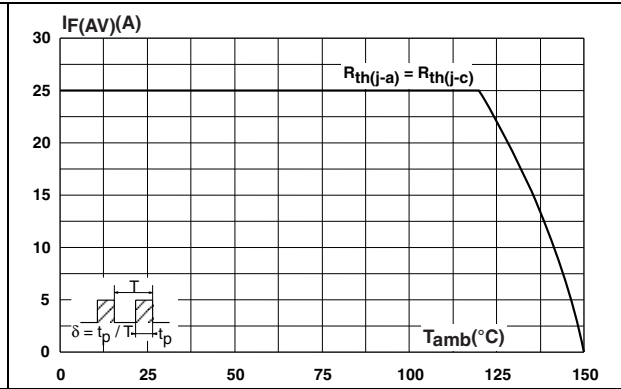

Figure 5. Relative variation of thermal impedance junction to case versus pulse duration

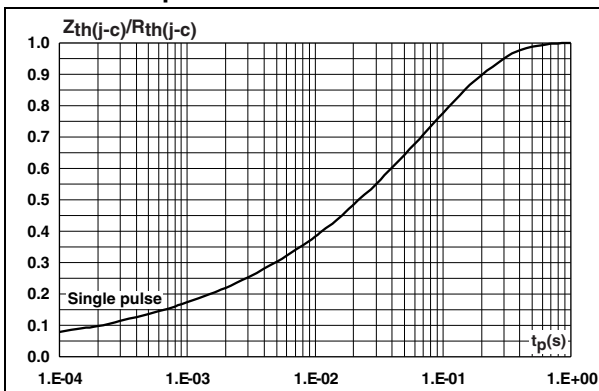

Figure 6. Junction capacitance versus reverse voltage applied (typical values, per diode)

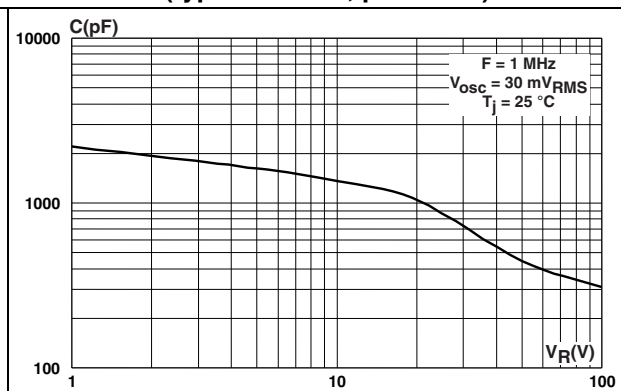
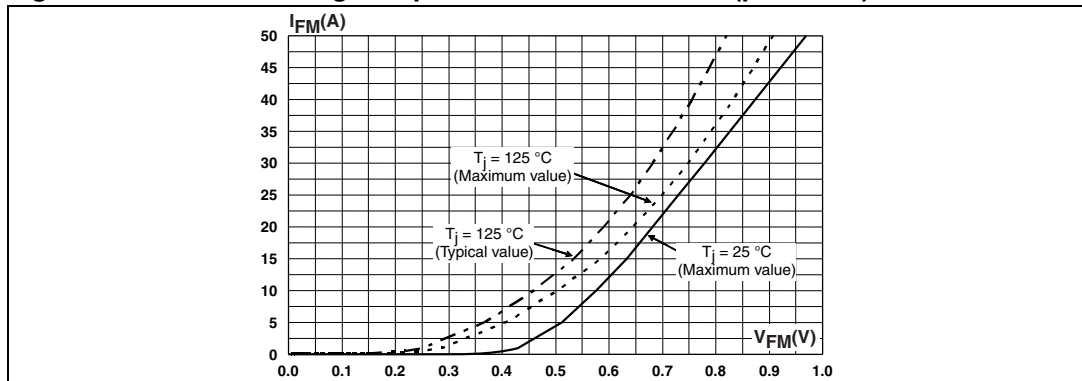

Figure 7. Forward voltage drop versus forward current (per diode)



2 Application information

It is mandatory to ensure a peak reverse voltage below the V_{RRM} absolute rating. ST recommends the use of an RC clamping snubber circuit in parallel with the STPS50U100C device.

Figure 8. Application schematic

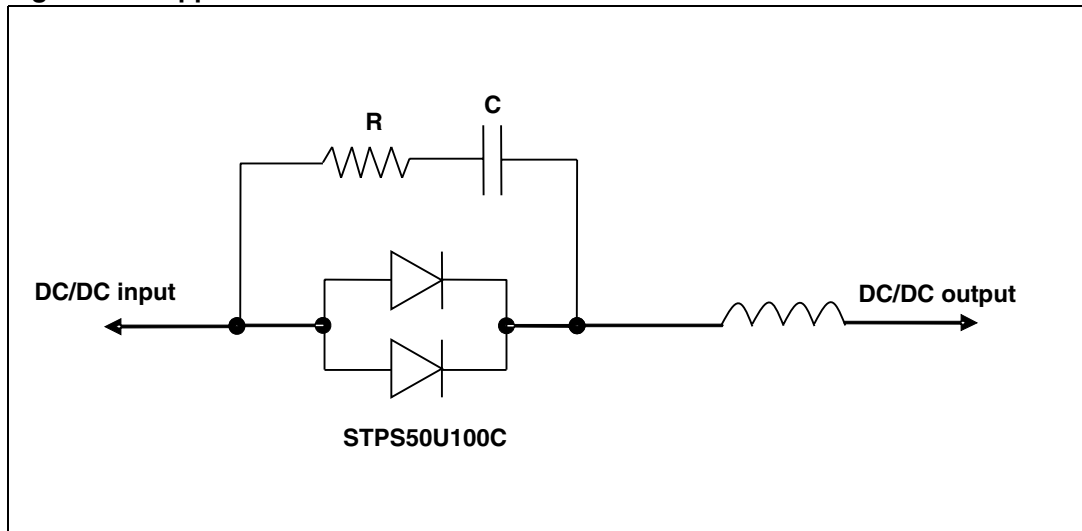

3 Package information

- Epoxy meets UL94,V0
- Cooling method: by conduction (C)
- Recommended torque value: 0.4 to 0.6 N·m

In order to meet environmental requirements, ST offers these devices in different grades of ECOPACK[®] packages, depending on their level of environmental compliance. ECOPACK[®] specifications, grade definitions and product status are available at: www.st.com. ECOPACK[®] is an ST trademark.

Table 5. TO-220AB dimensions

Ref.	Dimensions			
	Millimeters		Inches	
	Min.	Max.	Min.	Max.
A	4.40	4.60	0.173	0.181
C	1.23	1.32	0.048	0.051
D	2.40	2.72	0.094	0.107
E	0.49	0.70	0.019	0.027
F	0.61	0.88	0.024	0.034
F1	1.14	1.70	0.044	0.066
F2	1.14	1.70	0.044	0.066
G	4.95	5.15	0.194	0.202
G1	2.40	2.70	0.094	0.106
H2	10	10.40	0.393	0.409
L2	16.4 typ.		0.645 typ.	
L4	13	14	0.511	0.551
L5	2.65	2.95	0.104	0.116
L6	15.25	15.75	0.600	0.620
L7	6.20	6.60	0.244	0.259
L9	3.50	3.93	0.137	0.154
M	2.6 typ.		0.102 typ.	
Dia.	3.75	3.85	0.147	0.151

Mounting (soldering) the I²PAK metal slug (heatsink) with alloy, like a surface mount device, IS NOT PERMITTED. A standard through-hole mounting is mandatory.

Table 6. I²PAK dimensions

Ref.	Dimensions			
	Millimeters		Inches	
	Min.	Max.	Min.	Max.
A	4.40	4.60	0.173	0.181
A1	2.40	2.72	0.094	0.107
b	0.61	0.88	0.024	0.035
b1	1.14	1.70	0.044	0.067
c	0.49	0.70	0.019	0.028
c2	1.23	1.32	0.048	0.052
D	8.95	9.35	0.352	0.368
e	2.40	2.70	0.094	0.106
e1	4.95	5.15	0.195	0.203
E	10	10.40	0.394	0.409
L	13	14	0.512	0.551
L1	3.50	3.93	0.138	0.155
L2	1.27	1.40	0.050	0.055

4 Ordering information

Table 7. Ordering information

Order code	Marking	Package	Weight	Base qty	Delivery mode
STPS50U100CT	STPS50U100C	TO-220AB	2.23 g	50	Tube
STPS50U100CR	STPS50U100C	I ² PAK	1.49 g	50	Tube

For the latest information on available order codes see the product pages on www.st.com.

5 Revision history

Table 8. Document revision history

Date	Revision	Changes
17-Nov-2009	1	First release.
04-Nov-2010	2	Added trademark statement for UVLF.

Please Read Carefully:

Information in this document is provided solely in connection with ST products. STMicroelectronics NV and its subsidiaries ("ST") reserve the right to make changes, corrections, modifications or improvements, to this document, and the products and services described herein at any time, without notice.

All ST products are sold pursuant to ST's terms and conditions of sale.

Purchasers are solely responsible for the choice, selection and use of the ST products and services described herein, and ST assumes no liability whatsoever relating to the choice, selection or use of the ST products and services described herein.

No license, express or implied, by estoppel or otherwise, to any intellectual property rights is granted under this document. If any part of this document refers to any third party products or services it shall not be deemed a license grant by ST for the use of such third party products or services, or any intellectual property contained therein or considered as a warranty covering the use in any manner whatsoever of such third party products or services or any intellectual property contained therein.

UNLESS OTHERWISE SET FORTH IN ST'S TERMS AND CONDITIONS OF SALE ST DISCLAIMS ANY EXPRESS OR IMPLIED WARRANTY WITH RESPECT TO THE USE AND/OR SALE OF ST PRODUCTS INCLUDING WITHOUT LIMITATION IMPLIED WARRANTIES OF MERCHANTABILITY, FITNESS FOR A PARTICULAR PURPOSE (AND THEIR EQUIVALENTS UNDER THE LAWS OF ANY JURISDICTION), OR INFRINGEMENT OF ANY PATENT, COPYRIGHT OR OTHER INTELLECTUAL PROPERTY RIGHT.

UNLESS EXPRESSLY APPROVED IN WRITING BY AN AUTHORIZED ST REPRESENTATIVE, ST PRODUCTS ARE NOT RECOMMENDED, AUTHORIZED OR WARRANTED FOR USE IN MILITARY, AIR CRAFT, SPACE, LIFE SAVING, OR LIFE SUSTAINING APPLICATIONS, NOR IN PRODUCTS OR SYSTEMS WHERE FAILURE OR MALFUNCTION MAY RESULT IN PERSONAL INJURY, DEATH, OR SEVERE PROPERTY OR ENVIRONMENTAL DAMAGE. ST PRODUCTS WHICH ARE NOT SPECIFIED AS "AUTOMOTIVE GRADE" MAY ONLY BE USED IN AUTOMOTIVE APPLICATIONS AT USER'S OWN RISK.

Resale of ST products with provisions different from the statements and/or technical features set forth in this document shall immediately void any warranty granted by ST for the ST product or service described herein and shall not create or extend in any manner whatsoever, any liability of ST.

ST and the ST logo are trademarks or registered trademarks of ST in various countries.

Information in this document supersedes and replaces all information previously supplied.

The ST logo is a registered trademark of STMicroelectronics. All other names are the property of their respective owners.

© 2010 STMicroelectronics - All rights reserved

STMicroelectronics group of companies

Australia - Belgium - Brazil - Canada - China - Czech Republic - Finland - France - Germany - Hong Kong - India - Israel - Italy - Japan - Malaysia - Malta - Morocco - Philippines - Singapore - Spain - Sweden - Switzerland - United Kingdom - United States of America

www.st.com

OUR CERTIFICATE

DiGi provide top-quality products and perfect service for customer worldwide through standardization, technological innovation and continuous improvement. DiGi through third-party certification, we stricly control the quality of products and services. Welcome your RFQ to

Email: Info@DiGi-Electronics.com



Tel: +00 852-30501935

RFQ Email: Info@DiGi-Electronics.com

DiGi is a global authorized distributor of electronic components.