

USBLC6-4SC6Y Datasheet

www.digi-electronics.com

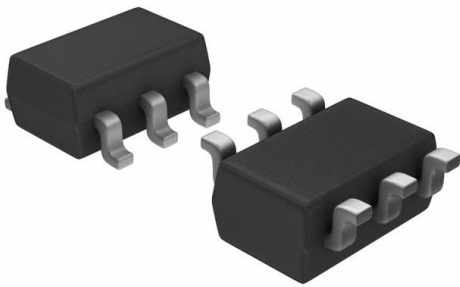

<https://www.DiGi-Electronics.com>

DiGi Electronics Part Number	USBLC6-4SC6Y-DG
Manufacturer	STMicroelectronics
Manufacturer Product Number	USBLC6-4SC6Y
Description	TVS DIODE 5.25VWM 17VC SOT23-6
Detailed Description	17V Clamp 5A (8/20µs) Ipp Tvs Diode Surface Mount SOT-23-6

This model USBLC6-4SC6Y is available at DiGi Electronics.

DiGi Electronics offers a global database of semiconductor and electronic component datasheets.

We welcome your inquiries regarding pricing, lead time, or other product-related questions.

 [Request a Quote](#)

 [Datasheet Search](#)



Tel: +00 852-30501935

RFQ Email: Info@DiGi-Electronics.com

DiGi is a global authorized distributor of electronic components.

Purchase and inquiry

Manufacturer Product Number:

USBLC6-4SC6Y

Series:

USBY

Type:

Steering (Rail to Rail)

Voltage - Reverse Standoff (Typ):

5.25V

Voltage - Clamping (Max) @ Ipp:

17V

Power - Peak Pulse:

-

Applications:

Ethernet

Operating Temperature:

-40°C ~ 125°C (TJ)

Qualification:

AEC-Q101

Package / Case:

SOT-23-6

Base Product Number:

USBLC6

Manufacturer:

STMicroelectronics

Product Status:

Active

Unidirectional Channels:

4

Voltage - Breakdown (Min):

6V

Current - Peak Pulse (10/1000µs):

5A (8/20µs)

Power Line Protection:

Yes

Capacitance @ Frequency:

-

Grade:

Automotive

Mounting Type:

Surface Mount

Supplier Device Package:

SOT-23-6

Environmental & Export classification

RoHS Status:

ROHS3 Compliant

REACH Status:

REACH Unaffected

HTSUS:

8541.10.0080

Moisture Sensitivity Level (MSL):

1 (Unlimited)

ECCN:

EAR99



USBLC6-4SC6Y

Automotive very low capacitance ESD protection

Datasheet – production data

Features

- 4 data-line protection
- Protects V_{BUS}
- Very low capacitance: 3 pF
- Very low leakage current: 10 nA
- SOT23-6L package
- RoHS compliant
- AEC Q101 qualified

Benefits

- Very low capacitance between lines to GND for optimized data integrity and speed
- Low PCB space consumption, 9 mm² maximum foot print
- Enhanced ESD protection: ISO10605 up to 25 kV guaranteed at device level
- ESD protection of V_{BUS}
- High reliability offered by monolithic integration
- Fast response time
- Consistent D+ / D- signal balance:
 - Very low capacitance matching tolerance
 - I/O to GND = 0.015 pF
 - Compliant with USB 2.0 requirements

Complies with the following standards

- ISO10605, C = 150 pF, R = 330 Ω
 - 25 kV (air discharge)
 - 15 kV (contact discharge)
- ISO10605, C = 330 pF, R = 330 Ω
 - 15 kV (air discharge)
 - 15 kV (contact discharge)
- ISO 7637-3
 - Pulse 3a: $V_s = -150$ V
 - Pulse 3b: $V_s = +100$ V

TM: Transil is a trademark of STMicroelectronics

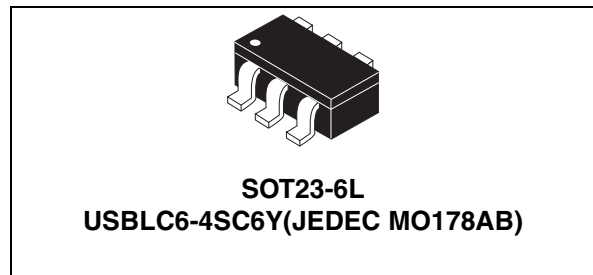
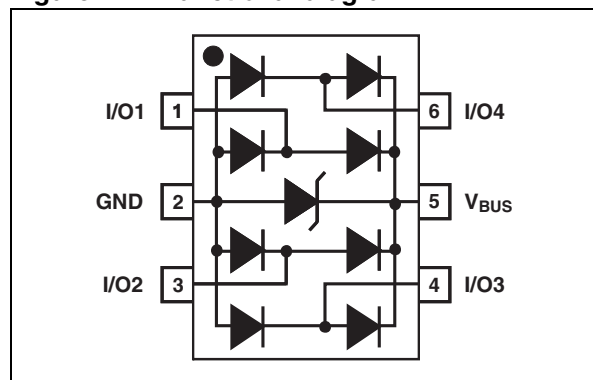

Figure 1. Functional diagram



Applications

- USB 2.0 ports up to 480 Mb/s (high speed)
- Compatible with USB 1.1 low and full speed
- High-speed data lines in smart junction boxes
- Ethernet port: 10/100 Mb/s
- Video line protection

Description

The USBLC6-4SC6Y is a monolithic device dedicated to ESD protection of high speed interfaces, such as USB 2.0, Ethernet links and video lines.

Its very low line capacitance secures a high level of signal integrity without compromising in protecting sensitive chips against the most stringent characterized ESD strikes.

1 Characteristics

Table 1. Absolute maximum ratings ($t_{amb} = 25\text{ }^{\circ}\text{C}$) - Generic parameters

Symbol	Parameter		Value	Unit
V_{PP}	Peak pulse voltage	ISO10605 (C = 330 pF, R = 330 Ω):		
		air discharge	15	kV
		contact discharge	15	
		ISO10605 (C = 150 pF, R = 330 Ω):		
air discharge	25			
contact discharge	15			
T_{stg}	Storage temperature range		-55 to +150	$^{\circ}\text{C}$
T_j	Operating junction temperature range		-40 to +150	$^{\circ}\text{C}$
T_L	Lead solder temperature (10 seconds duration)		260	$^{\circ}\text{C}$

Note: 1 For a surge greater than the maximum values, the diode will fail in short-circuit.

Figure 2. Electrical characteristics (definitions)

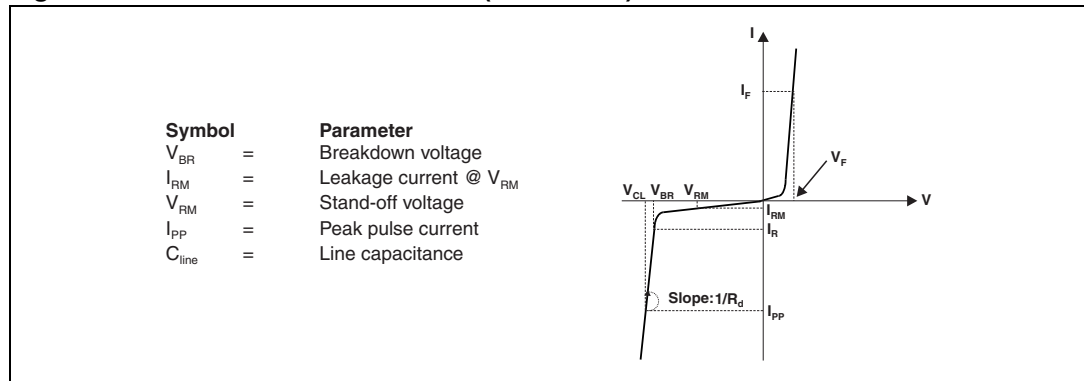

Table 2. Electrical characteristics ($T_{amb} = 25\text{ }^{\circ}\text{C}$)

Symbol	Parameter	Test Conditions	Value			Unit
			Min.	Typ.	Max.	
I_{RM}	Leakage current	$V_{RM} = 5.25\text{ V}$		10	150	nA
V_{BR}	Breakdown voltage between V_{BUS} and GND	$I_R = 1\text{ mA}$	6			V
V_F	Forward voltage	$I_F = 10\text{ mA}$			0.86	V
V_{CL}	Clamping voltage	$I_{PP} = 1\text{ A}, 8/20\text{ }\mu\text{s}$ Any I/O pin to GND			12	V
		$I_{PP} = 5\text{ A}, 8/20\text{ }\mu\text{s}$ Any I/O pin to GND			17	V
$C_{i/o-GND}$	Capacitance between I/O and GND	$V_R = 1.65\text{ V}$		3	4	pF
$\Delta C_{i/o-GND}$				0.015		
$C_{i/o-i/o}$	Capacitance between I/O	$V_R = 1.65\text{ V}$		1.85	2.7	pF
$\Delta C_{i/o-i/o}$				0.04		

Figure 3. Capacitance versus voltage (typical values)

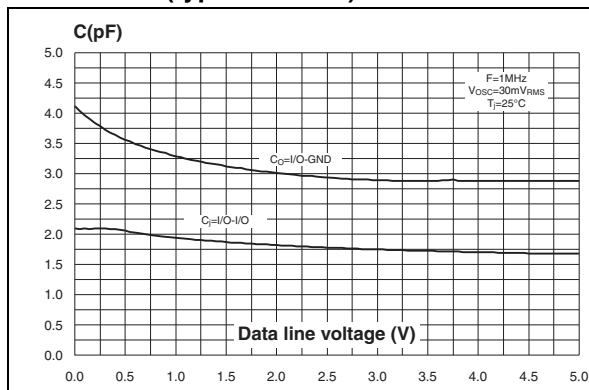

Figure 4. Line capacitance versus frequency (typical values)

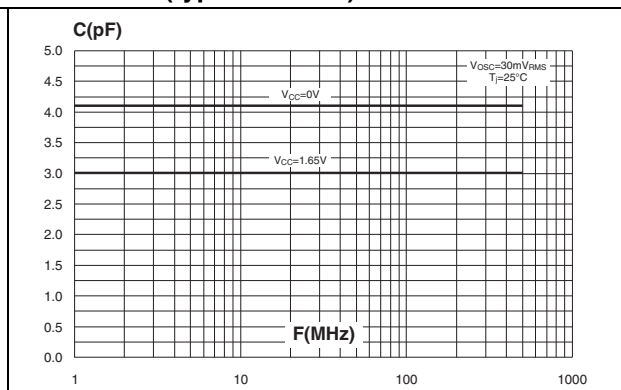

Figure 5. Relative variation of leakage current versus junction temperature (typical values)

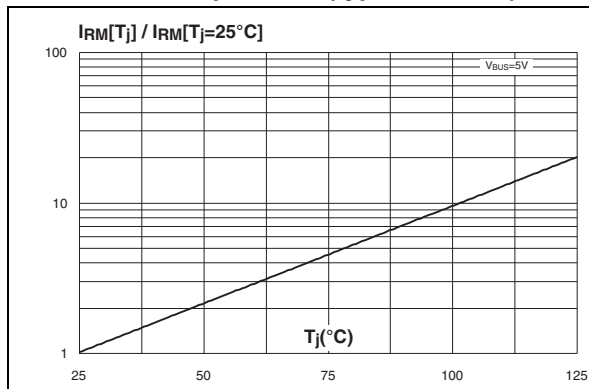

Figure 6. Frequency response

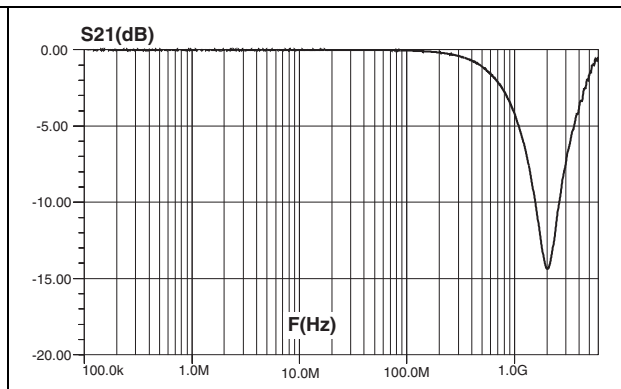

Figure 7. ESD response to ISO10605, C = 150 pF, R = 330 Ω (+15 kV air discharge)

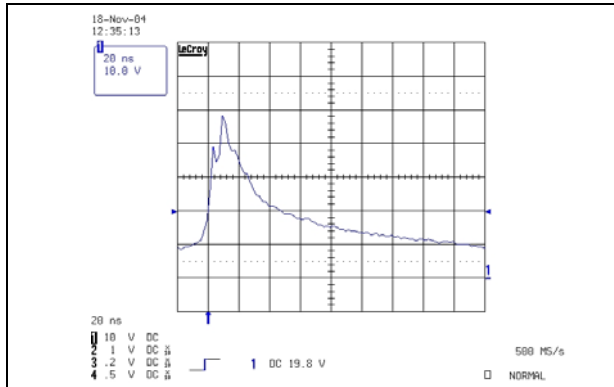

Figure 8. ESD response to ISO10605, C = 150 pF, R = 330 Ω (-15 kV air discharge)

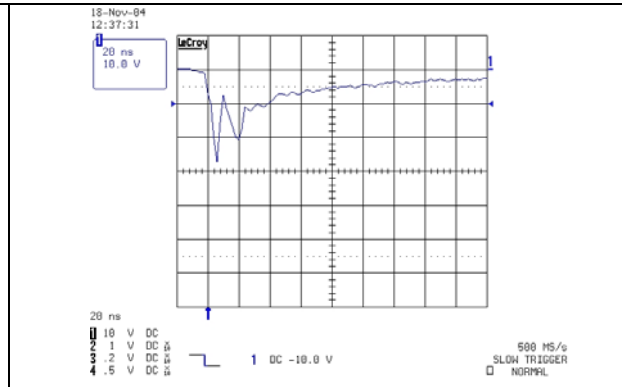
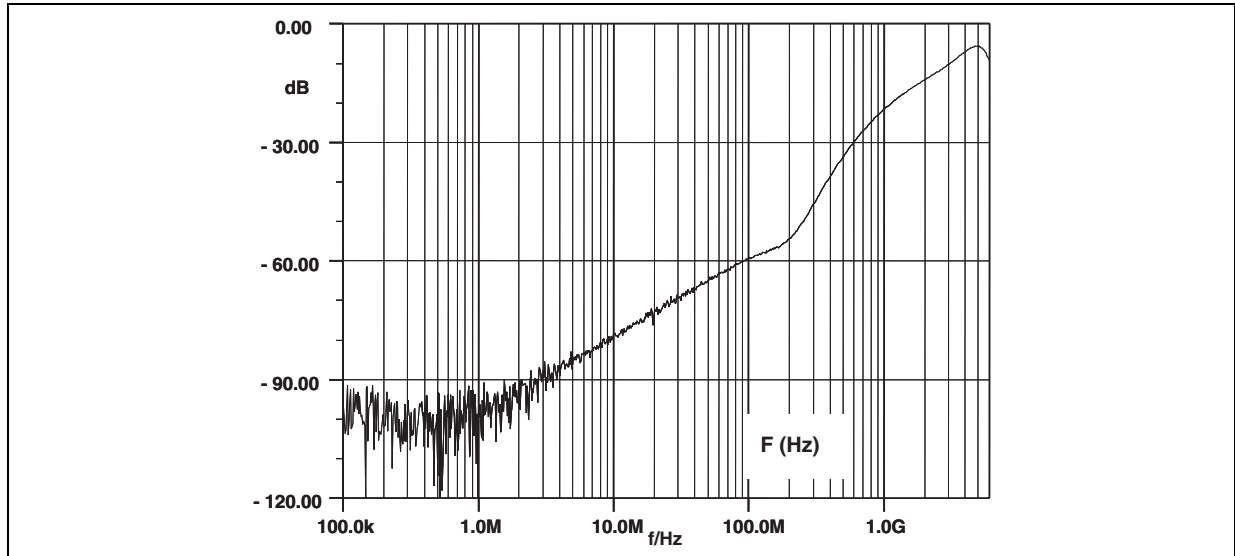

Figure 9. Analog crosstalk results



2 Application and design guidelines

More information is available in the STMicroelectronics Application note AN2689, “Protection of automotive electronics from electrical hazards, guidelines for design and component selection”.

3 Ordering information scheme

Figure 10. Ordering information scheme

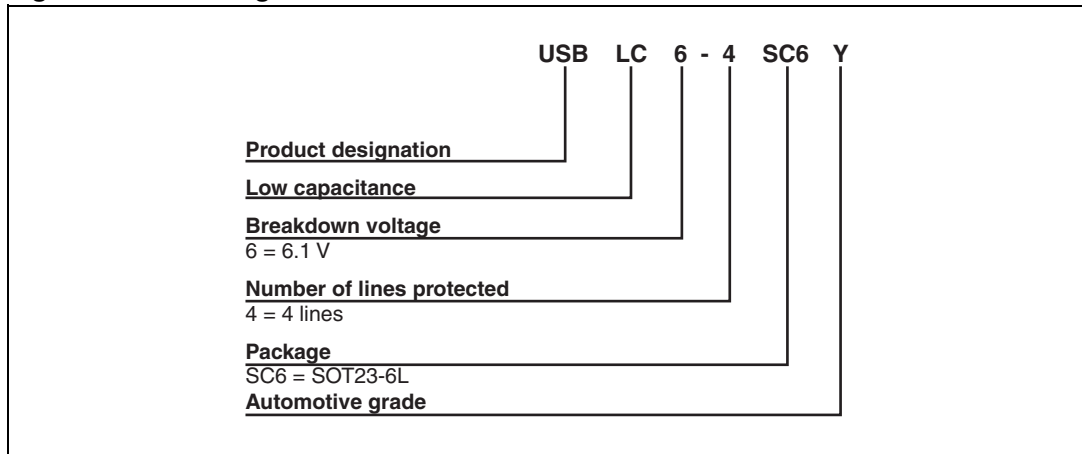

4 Package information

- Epoxy meets UL94, V0
- Lead-free package

In order to meet environmental requirements, ST offers these devices in different grades of ECOPACK® packages, depending on their level of environmental compliance. ECOPACK® specifications, grade definitions and product status are available at: www.st.com. ECOPACK® is an ST trademark.

Table 3. SOT23-6L dimensions

Ref.	Dimensions					
	Millimeters			Inches		
	Min.	Typ.	Max.	Min.	Typ.	Max.
A	0.90		1.45	0.035		0.057
A1	0		0.15	0		0.006
A2	0.90		1.30	0.035		0.051
b	0.30		0.50	0.012		0.02
C	0.09		0.20	0.004		0.008
D	2.80		3.05	0.110		0.120
E	1.50		1.75	0.059		0.069
e		0.95			0.037	
H	2.60		3.00	0.102		0.118
L	0.30		0.60	0.012		0.024
θ	0°		10°	0°		10°

Figure 11. SOT23-6L footprint (mm)

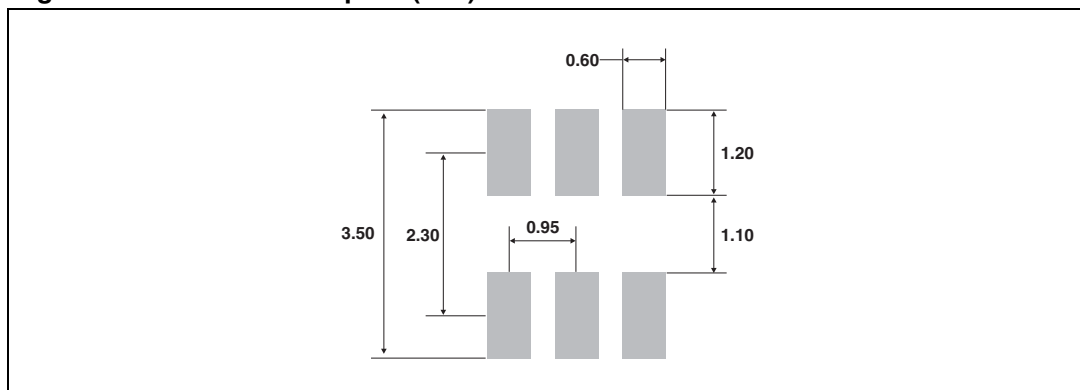

5 Recommendation on PCB assembly

5.1 Solder paste

1. Use halide-free flux, qualification ROL0 according to ANSI/J-STD-004.
2. "No clean" solder paste recommended.
3. Offers a high tack force to resist component displacement during PCB movement.
4. Use solder paste with fine particles: powder particle size 20-45 μm .

5.2 Placement

1. Manual positioning is not recommended.
2. It is recommended to use the lead recognition capabilities of the placement system, not the outline centering.
3. Standard tolerance of ± 0.05 mm is recommended.
4. 3.5 N placement force is recommended. Too much placement force can lead to squeezed out solder paste and cause solder joints to short. Too low placement force can lead to insufficient contact between package and solder paste that could cause open solder joints or badly centered packages.
5. To improve the package placement accuracy, a bottom side optical control should be performed with a high resolution tool.
6. For assembly, a perfect supporting of the PCB (all the more on flexible PCB) is recommended during solder paste printing, pick and place and reflow soldering by using optimized tools.

5.3 PCB design preference

1. To control the solder paste amount, the closed via is recommended instead of open vias.
2. The position of tracks and open vias in the solder area should be well balanced. The symmetrical layout is recommended, in case any tilt phenomena caused by asymmetrical solder paste amount due to the solder flow away.

5.4 Reflow profile

Figure 12. ST ECOPACK[®] recommended soldering reflow profile for PCB mounting

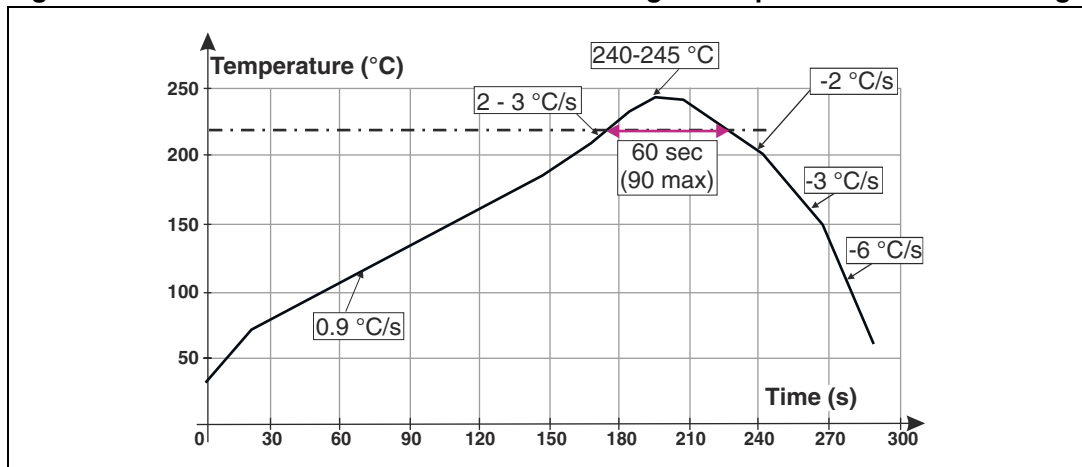

Note: Minimize air convection currents in the reflow oven to avoid component movement.

6 Ordering information

Table 4. Ordering information

Order code	Marking	Package	Weight	Base qty	Delivery mode
USBLC6-4SC6Y	UL4Y	SOT23-6L	16.7 mg	3000	Tape and reel

7 Revision history

Table 5. Document revision history

Date	Revision	Changes
14-May-2012	1	First issue.
06-Sep-2012	2	Updated dimensions A1 max, b min., and L min. in Table 3 .

Please Read Carefully:

Information in this document is provided solely in connection with ST products. STMicroelectronics NV and its subsidiaries ("ST") reserve the right to make changes, corrections, modifications or improvements, to this document, and the products and services described herein at any time, without notice.

All ST products are sold pursuant to ST's terms and conditions of sale.

Purchasers are solely responsible for the choice, selection and use of the ST products and services described herein, and ST assumes no liability whatsoever relating to the choice, selection or use of the ST products and services described herein.

No license, express or implied, by estoppel or otherwise, to any intellectual property rights is granted under this document. If any part of this document refers to any third party products or services it shall not be deemed a license grant by ST for the use of such third party products or services, or any intellectual property contained therein or considered as a warranty covering the use in any manner whatsoever of such third party products or services or any intellectual property contained therein.

UNLESS OTHERWISE SET FORTH IN ST'S TERMS AND CONDITIONS OF SALE ST DISCLAIMS ANY EXPRESS OR IMPLIED WARRANTY WITH RESPECT TO THE USE AND/OR SALE OF ST PRODUCTS INCLUDING WITHOUT LIMITATION IMPLIED WARRANTIES OF MERCHANTABILITY, FITNESS FOR A PARTICULAR PURPOSE (AND THEIR EQUIVALENTS UNDER THE LAWS OF ANY JURISDICTION), OR INFRINGEMENT OF ANY PATENT, COPYRIGHT OR OTHER INTELLECTUAL PROPERTY RIGHT.

UNLESS EXPRESSLY APPROVED IN WRITING BY TWO AUTHORIZED ST REPRESENTATIVES, ST PRODUCTS ARE NOT RECOMMENDED, AUTHORIZED OR WARRANTED FOR USE IN MILITARY, AIR CRAFT, SPACE, LIFE SAVING, OR LIFE SUSTAINING APPLICATIONS, NOR IN PRODUCTS OR SYSTEMS WHERE FAILURE OR MALFUNCTION MAY RESULT IN PERSONAL INJURY, DEATH, OR SEVERE PROPERTY OR ENVIRONMENTAL DAMAGE. ST PRODUCTS WHICH ARE NOT SPECIFIED AS "AUTOMOTIVE GRADE" MAY ONLY BE USED IN AUTOMOTIVE APPLICATIONS AT USER'S OWN RISK.

Resale of ST products with provisions different from the statements and/or technical features set forth in this document shall immediately void any warranty granted by ST for the ST product or service described herein and shall not create or extend in any manner whatsoever, any liability of ST.

ST and the ST logo are trademarks or registered trademarks of ST in various countries.

Information in this document supersedes and replaces all information previously supplied.

The ST logo is a registered trademark of STMicroelectronics. All other names are the property of their respective owners.

© 2012 STMicroelectronics - All rights reserved

STMicroelectronics group of companies

Australia - Belgium - Brazil - Canada - China - Czech Republic - Finland - France - Germany - Hong Kong - India - Israel - Italy - Japan - Malaysia - Malta - Morocco - Philippines - Singapore - Spain - Sweden - Switzerland - United Kingdom - United States of America

www.st.com

OUR CERTIFICATE

DiGi provide top-quality products and perfect service for customer worldwide through standardization, technological innovation and continuous improvement. DiGi through third-party certification, we stricly control the quality of products and services. Welcome your RFQ to

Email: Info@DiGi-Electronics.com



Tel: +00 852-30501935

RFQ Email: Info@DiGi-Electronics.com

DiGi is a global authorized distributor of electronic components.