

# C1608X7R1H101M Datasheet

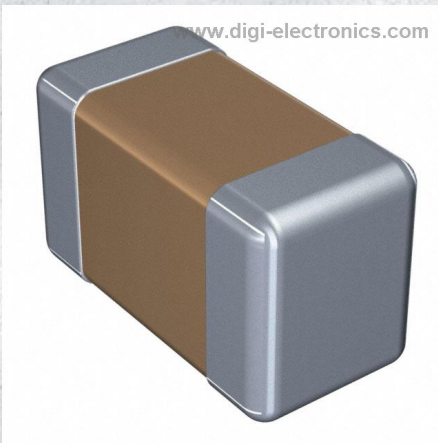

<https://www.DiGi-Electronics.com>

DiGi Electronics Part Number	C1608X7R1H101M-DG
Manufacturer	<a href="#">TDK Corporation</a>
Manufacturer Product Number	C1608X7R1H101M
Description	CAP CER 100PF 50V X7R 0603
Detailed Description	100 pF ±20% 50V Ceramic Capacitor X7R 0603 (1608 Metric)

This model C1608X7R1H101M is available at DiGi Electronics.

DiGi Electronics offers a global database of semiconductor and electronic component datasheets.

We welcome your inquiries regarding pricing, lead time, or other product-related questions.

 [Request a Quote](#)

 [Datasheet Search](#)



Tel: +00 852-30501935

RFQ Email: [Info@DiGi-Electronics.com](mailto:Info@DiGi-Electronics.com)

DiGi is a global authorized distributor of electronic components.

## Purchase and inquiry

Manufacturer Product Number:

C1608X7R1H101M

Series:

C

Capacitance:

100 pF

Voltage - Rated:

50V

Operating Temperature:

-55°C ~ 125°C

Ratings:

-

Failure Rate:

-

Package / Case:

0603 (1608 Metric)

Height - Seated (Max):

-

Lead Spacing:

-

Manufacturer:

TDK Corporation

Product Status:

Obsolete

Tolerance:

±20%

Temperature Coefficient:

X7R

Features:

-

Applications:

General Purpose

Mounting Type:

Surface Mount, MLCC

Size / Dimension:

0.063" L x 0.031" W (1.60mm x 0.80mm)

Thickness (Max):

0.035" (0.90mm)

Lead Style:

-

## Environmental & Export classification

Moisture Sensitivity Level (MSL):

1 (Unlimited)

ECCN:

EAR99

REACH Status:

REACH Unaffected

HTSUS:

8532.24.0020



# MULTILAYER CERAMIC CHIP CAPACITORS



## C Series General Application

Type: C0402 [EIA CC01005]  
C0603 [EIA CC0201]  
C1005 [EIA CC0402]  
C1608 [EIA CC0603]  
C2012 [EIA CC0805]  
C3216 [EIA CC1206]  
C3225 [EIA CC1210]  
C4532 [EIA CC1812]  
C5750 [EIA CC2220]

Issue date: April 2011



**TDK MLCC  
US Catalog**

Version B11

## REMINDERS

Please read before using this product

### SAFETY REMINDERS



### REMINDERS

1. If you intend to use a product listed in this catalog for a purpose that may cause loss of life or other damage, you must contact our company's sales window.
2. We may modify products or discontinue production of a product listed in this catalog without prior notification.
3. We provide "Delivery Specification" that explain precautions for the specifications and safety of each product listed in this catalog. We strongly recommend that you exchange these delivery specifications with customers that use one of these products.
4. If you plan to export a product listed in this catalog, keep in mind that it may be a restricted item according to the "Foreign Exchange and Foreign Trade Control Law". In such cases, it is necessary to acquire export permission in harmony with this law.
5. Any reproduction or transferring of the contents of this catalog is prohibited without prior permission from our company.
6. We are not responsible for problems that occur related to the intellectual property rights or other rights of our company or a third party when you use a product listed in this catalog. We do not grant license of these rights.
7. This catalog only applies to products purchased through our company or one of our company's official agencies. This catalog does not apply to products that are purchased through other third parties.



# C Series General Application

Type: C0402, C0603, C1005, C1608,  
C2012, C3216, C3225, C4532, C5750

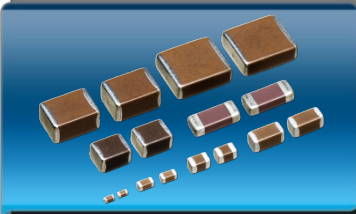

## Features



- High capacitance has been achieved through precision technologies that enable the use of multiple thinner ceramic dielectric layers.
- A monolithic structure ensures superior mechanical strength and reliability.
- High-accuracy automatic mounting is facilitated through the maintenance of very precise dimensional tolerances.
- Composed of only ceramics and metals, these capacitors provide extremely dependable performance, exhibiting virtually no degradation even when subjected to temperature extremes.
- Low stray capacitance ensures high conformity with nominal values, thereby simplifying the circuit design process.
- Low residual inductance assures superior frequency characteristics.
- Because electrostatic capacity has been obtained up to the electrolytic capacitor range, these capacitors offer long service life and are optimally suited for power supply designs that require high levels of reliability.
- Owing to their low ESR and excellent frequency characteristics, these products are optimally suited for high frequency and high-density type power supplies.

## Applications



- Electronics equipment
- Mobile communications equipment
- Office automation equipment
- Automotive electronics
- Test and measurement equipment
- Hybrid ICs, etc.
- Decoupling
- Smoothing
- Charge pump

## Shape & Dimensions

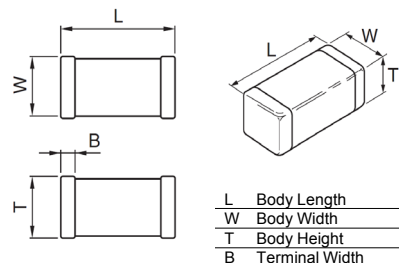

Dimensions in mm

L	Body Length
W	Body Width
T	Body Height
B	Terminal Width

## Part Number Construction

Series Name **C 2012 X7R 1E 105 K T XXXX**

### Dimensions L x W (mm)

Case Code	Length	Width
C0402	0.40 ± 0.02	0.20 ± 0.02
C0603	0.60 ± 0.03	0.30 ± 0.03
C1005	1.00 ± 0.05	0.50 ± 0.05
C1608	1.60 ± 0.10	0.80 ± 0.10
C2012	2.00 ± 0.20	1.25 ± 0.20
C3216	3.20 ± 0.20	1.60 ± 0.20
C3225	3.20 ± 0.40	2.50 ± 0.30
C4532	4.50 ± 0.40	3.20 ± 0.40
C5750	5.70 ± 0.40	5.00 ± 0.40

### Temperature Characteristic

Temperature Characteristics	Capacitance Change	Temperature Range
C0G	0±30 ppm/°C	-55 to +125°C
SL	+350/-1000 ppm/°C	-25 to +85°C
X5R	±15%	-55 to +85°C
X6S	+22%	-55 to +105°C
X7R	±15%	-55 to +125°C
X7S	+22%	-55 to +125°C
Y5V	+22/-82%	-33 to +85°C

### Rated Voltage (DC)

Voltage Code	Voltage (DC)	Voltage Code	Voltage (DC)	Voltage Code	Voltage (DC)
0G	4V	1C	16V	1H	50V
0J	6.3V	1E	25V		
1A	10V	1V	35V		

### Internal Codes

#### Packaging Style

Packaging Code	Style
T	Tape & Reel

#### Capacitance Tolerance

Tolerance Code	Tolerance
W	± 0.05 pF
B	± 0.10 pF
C	± 0.25 pF
D	± 0.50 pF
E	± 0.20 pF
G	± 2%
J	± 5%
K	± 10%
M	± 20%
Z	+80-20%

#### Nominal Capacitance (pF)

The capacitance is expressed in three digit codes and in units of pico Farads (pF). The first and second digits identify the first and second significant figures of the capacitance. The third digit identifies the multiplier. R designates a decimal point.

Capacitance Code	Capacitance
0R5	0.5pF
010	1pF
102	1,000pF (1nF)
105	1,000,000pF (1µF)



## Capacitance Range Chart

## C0402 [EIA CC01005]

### Capacitance Range Chart

Temperature Characteristics: C0G ( $0 \pm 30\text{ppm}/^\circ\text{C}$ )  
 Rated Voltage: 16V (1C)

Capacitance (pF)	Cap Code	Tolerance	C0G
			1C (16V)
0.1	0R1	W: $\pm 0.05\text{pF}$	
0.2	0R2	B: $\pm 0.10\text{pF}$	
0.3	0R3	C: $\pm 0.25\text{pF}$	
0.4	0R4	D: $\pm 0.50\text{pF}$	
0.5	0R5		
0.6	0R6		
0.7	0R7		
0.8	0R8		
0.9	0R9		
1	010		
1.1	1R1		
1.2	1R2		
1.3	1R3		
1.5	1R5		
1.6	1R6		
1.8	1R8		
2	020		
2.2	2R2		
2.4	2R4		
2.7	2R7		
3	030		
3.3	3R3		
3.6	3R6		
3.9	3R9		
4.3	4R3		
4.7	4R7		
5.1	5R1		
5.6	5R6		
6.2	6R2		

Capacitance (pF)	Cap Code	Tolerance	C0G
			1C (16V)
6.8	6R8	B: $\pm 0.10\text{pF}$	
7.5	7R5	E: $\pm 0.20\text{pF}$	
8.2	8R2	C: $\pm 0.25\text{pF}$	
9.1	9R1	D: $\pm 0.50\text{pF}$	
10	100	G: $\pm 2\%$	
11	110	J: $\pm 5\%$	
12	120		
13	130		
15	150		
16	160		
18	180		
20	200		
22	220		
24	240		
27	270		
30	300		
33	330		
36	360		
39	390		
43	430		
47	470		
51	510		
56	560		
62	620		
68	680		
75	750		
82	820		
91	910		
100	101		

• Standard capacitance is shown. Please refer to Capacitance Range Table for additional capacitance values.

### Capacitance Range Chart

Temperature Characteristics: X7R ( $\pm 15\%$ ), X5R ( $\pm 15\%$ )  
 Rated Voltage: 16V (1C), 10V (1A), 6.3V (0J)

Capacitance (pF)	Cap Code	Tolerance	X7R		X5R	
			1A (10V)	1C (16V)	1A (10V)	0J (6.3V)
100	101	K: $\pm 10\%$				
150	151					
220	221					
330	331					
470	471					
680	681					
1,000	102					
1,500	152					
2,200	222					
3,300	332					
4,700	472					
6,800	682					
10,000	103					

Standard Thickness

0.20 mm



## Capacitance Range Table

# C0402 [EIA CC01005]

### Class 1 (Temperature Compensating)

Temperature Characteristics: C0G (-55 to 125°C, 0±30 ppm/°C)

TDK Part Number (Ordering Code)	Temperature Characteristics	Rated Voltage	Capacitance (pF)	Capacitance Tolerance	Thickness (mm)
C0402C0G1C0R2W	C0G	16V	0.2	± 0.05pF	0.20 ± 0.02
C0402C0G1C0R2B	C0G	16V	0.2	± 0.10pF	0.20 ± 0.02
C0402C0G1C0R3W	C0G	16V	0.3	± 0.05pF	0.20 ± 0.02
C0402C0G1C0R3B	C0G	16V	0.3	± 0.10pF	0.20 ± 0.02
C0402C0G1C0R4W	C0G	16V	0.4	± 0.05pF	0.20 ± 0.02
C0402C0G1C0R4B	C0G	16V	0.4	± 0.10pF	0.20 ± 0.02
C0402C0G1C0R5W	C0G	16V	0.5	± 0.05pF	0.20 ± 0.02
C0402C0G1C0R5C	C0G	16V	0.5	± 0.25pF	0.20 ± 0.02
C0402C0G1C0R5B	C0G	16V	0.5	± 0.10pF	0.20 ± 0.02
C0402C0G1C0R6W	C0G	16V	0.6	± 0.05pF	0.20 ± 0.02
C0402C0G1C0R6B	C0G	16V	0.6	± 0.10pF	0.20 ± 0.02
C0402C0G1C0R7W	C0G	16V	0.7	± 0.05pF	0.20 ± 0.02
C0402C0G1C0R7B	C0G	16V	0.7	± 0.10pF	0.20 ± 0.02
C0402C0G1C0R8W	C0G	16V	0.8	± 0.05pF	0.20 ± 0.02
C0402C0G1C0R8B	C0G	16V	0.8	± 0.10pF	0.20 ± 0.02
C0402C0G1C0R9W	C0G	16V	0.9	± 0.05pF	0.20 ± 0.02
C0402C0G1C0R9B	C0G	16V	0.9	± 0.10pF	0.20 ± 0.02
C0402C0G1C010B	C0G	16V	1.0	± 0.10pF	0.20 ± 0.02
C0402C0G1C010C	C0G	16V	1.0	± 0.25pF	0.20 ± 0.02
C0402C0G1C1R1B	C0G	16V	1.1	± 0.10pF	0.20 ± 0.02
C0402C0G1C1R1C	C0G	16V	1.1	± 0.25pF	0.20 ± 0.02
C0402C0G1C1R2B	C0G	16V	1.2	± 0.10pF	0.20 ± 0.02
C0402C0G1C1R2C	C0G	16V	1.2	± 0.25pF	0.20 ± 0.02
C0402C0G1C1R3B	C0G	16V	1.3	± 0.10pF	0.20 ± 0.02
C0402C0G1C1R3C	C0G	16V	1.3	± 0.25pF	0.20 ± 0.02
C0402C0G1C1R5B	C0G	16V	1.5	± 0.10pF	0.20 ± 0.02
C0402C0G1C1R5C	C0G	16V	1.5	± 0.25pF	0.20 ± 0.02
C0402C0G1C1R6B	C0G	16V	1.6	± 0.10pF	0.20 ± 0.02
C0402C0G1C1R6C	C0G	16V	1.6	± 0.25pF	0.20 ± 0.02
C0402C0G1C1R8B	C0G	16V	1.8	± 0.10pF	0.20 ± 0.02
C0402C0G1C1R8C	C0G	16V	1.8	± 0.25pF	0.20 ± 0.02
C0402C0G1C020B	C0G	16V	2.0	± 0.10pF	0.20 ± 0.02
C0402C0G1C020C	C0G	16V	2.0	± 0.25pF	0.20 ± 0.02
C0402C0G1C2R2B	C0G	16V	2.2	± 0.10pF	0.20 ± 0.02
C0402C0G1C2R2C	C0G	16V	2.2	± 0.25pF	0.20 ± 0.02
C0402C0G1C2R4B	C0G	16V	2.4	± 0.10pF	0.20 ± 0.02
C0402C0G1C2R4C	C0G	16V	2.4	± 0.25pF	0.20 ± 0.02
C0402C0G1C2R7B	C0G	16V	2.7	± 0.10pF	0.20 ± 0.02
C0402C0G1C2R7C	C0G	16V	2.7	± 0.25pF	0.20 ± 0.02
C0402C0G1C030B	C0G	16V	3.0	± 0.10pF	0.20 ± 0.02
C0402C0G1C030C	C0G	16V	3.0	± 0.25pF	0.20 ± 0.02
C0402C0G1C3R3B	C0G	16V	3.3	± 0.10pF	0.20 ± 0.02
C0402C0G1C3R3C	C0G	16V	3.3	± 0.25pF	0.20 ± 0.02
C0402C0G1C3R6B	C0G	16V	3.6	± 0.10pF	0.20 ± 0.02



## Capacitance Range Table

# C0402 [EIA CC01005]

### Class 1 (Temperature Compensating)

Temperature Characteristics: C0G (-55 to 125°C, 0±30 ppm/°C)

TDK Part Number (Ordering Code)	Temperature Characteristics	Rated Voltage	Capacitance (pF)	Capacitance Tolerance	Thickness (mm)
C0402C0G1C3R6C	C0G	16V	3.6	± 0.25pF	0.20 ± 0.02
C0402C0G1C3R9B	C0G	16V	3.9	± 0.10pF	0.20 ± 0.02
C0402C0G1C3R9C	C0G	16V	3.9	± 0.25pF	0.20 ± 0.02
C0402C0G1C040B	C0G	16V	4.0	± 0.10pF	0.20 ± 0.02
C0402C0G1C040C	C0G	16V	4.0	± 0.25pF	0.20 ± 0.02
C0402C0G1C4R3B	C0G	16V	4.3	± 0.10pF	0.20 ± 0.02
C0402C0G1C4R3C	C0G	16V	4.3	± 0.25pF	0.20 ± 0.02
C0402C0G1C4R7B	C0G	16V	4.7	± 0.10pF	0.20 ± 0.02
C0402C0G1C4R7C	C0G	16V	4.7	± 0.25pF	0.20 ± 0.02
C0402C0G1C050B	C0G	16V	5.0	± 0.10pF	0.20 ± 0.02
C0402C0G1C050C	C0G	16V	5.0	± 0.25pF	0.20 ± 0.02
C0402C0G1C5R1B	C0G	16V	5.1	± 0.10pF	0.20 ± 0.02
C0402C0G1C5R1C	C0G	16V	5.1	± 0.25pF	0.20 ± 0.02
C0402C0G1C5R1D	C0G	16V	5.1	± 0.50pF	0.20 ± 0.02
C0402C0G1C5R6B	C0G	16V	5.6	± 0.10pF	0.20 ± 0.02
C0402C0G1C5R6C	C0G	16V	5.6	± 0.25pF	0.20 ± 0.02
C0402C0G1C5R6D	C0G	16V	5.6	± 0.50pF	0.20 ± 0.02
C0402C0G1C060B	C0G	16V	6.0	± 0.10pF	0.20 ± 0.02
C0402C0G1C060C	C0G	16V	6.0	± 0.25pF	0.20 ± 0.02
C0402C0G1C060D	C0G	16V	6.0	± 0.50pF	0.20 ± 0.02
C0402C0G1C6R2B	C0G	16V	6.2	± 0.10pF	0.20 ± 0.02
C0402C0G1C6R2C	C0G	16V	6.2	± 0.25pF	0.20 ± 0.02
C0402C0G1C6R2D	C0G	16V	6.2	± 0.50pF	0.20 ± 0.02
C0402C0G1C6R8B	C0G	16V	6.8	± 0.10pF	0.20 ± 0.02
C0402C0G1C6R8C	C0G	16V	6.8	± 0.25pF	0.20 ± 0.02
C0402C0G1C6R8D	C0G	16V	6.8	± 0.50pF	0.20 ± 0.02
C0402C0G1C070B	C0G	16V	7.0	± 0.10pF	0.20 ± 0.02
C0402C0G1C070C	C0G	16V	7.0	± 0.25pF	0.20 ± 0.02
C0402C0G1C070D	C0G	16V	7.0	± 0.50pF	0.20 ± 0.02
C0402C0G1C7R5B	C0G	16V	7.5	± 0.10pF	0.20 ± 0.02
C0402C0G1C7R5C	C0G	16V	7.5	± 0.25pF	0.20 ± 0.02
C0402C0G1C7R5D	C0G	16V	7.5	± 0.50pF	0.20 ± 0.02
C0402C0G1C080B	C0G	16V	8.0	± 0.10pF	0.20 ± 0.02
C0402C0G1C080C	C0G	16V	8.0	± 0.25pF	0.20 ± 0.02
C0402C0G1C080D	C0G	16V	8.0	± 0.50pF	0.20 ± 0.02
C0402C0G1C8R2B	C0G	16V	8.2	± 0.10pF	0.20 ± 0.02
C0402C0G1C8R2C	C0G	16V	8.2	± 0.25pF	0.20 ± 0.02
C0402C0G1C8R2D	C0G	16V	8.2	± 0.50pF	0.20 ± 0.02
C0402C0G1C090B	C0G	16V	9.0	± 0.10pF	0.20 ± 0.02
C0402C0G1C090C	C0G	16V	9.0	± 0.25pF	0.20 ± 0.02
C0402C0G1C090D	C0G	16V	9.0	± 0.50pF	0.20 ± 0.02
C0402C0G1C9R1B	C0G	16V	9.1	± 0.10pF	0.20 ± 0.02
C0402C0G1C9R1C	C0G	16V	9.1	± 0.25pF	0.20 ± 0.02
C0402C0G1C9R1D	C0G	16V	9.1	± 0.50pF	0.20 ± 0.02



## Capacitance Range Table

## C0402 [EIA CC01005]

### Class 1 (Temperature Compensating)

Temperature Characteristics: C0G (-55 to 125°C, 0±30 ppm/°C)

TDK Part Number (Ordering Code)	Temperature Characteristics	Rated Voltage	Capacitance (pF)	Capacitance Tolerance	Thickness (mm)
C0402C0G1C100E	C0G	16V	10	± 0.20pF	0.20 ± 0.02
C0402C0G1C100D	C0G	16V	10	± 0.50pF	0.20 ± 0.02
C0402C0G1C110G	C0G	16V	11	± 2%	0.20 ± 0.02
C0402C0G1C110J	C0G	16V	11	± 5%	0.20 ± 0.02
C0402C0G1C120G	C0G	16V	12	± 2%	0.20 ± 0.02
C0402C0G1C120J	C0G	16V	12	± 5%	0.20 ± 0.02
C0402C0G1C130G	C0G	16V	13	± 2%	0.20 ± 0.02
C0402C0G1C130J	C0G	16V	13	± 5%	0.20 ± 0.02
C0402C0G1C150G	C0G	16V	15	± 2%	0.20 ± 0.02
C0402C0G1C150J	C0G	16V	15	± 5%	0.20 ± 0.02
C0402C0G1C160G	C0G	16V	16	± 2%	0.20 ± 0.02
C0402C0G1C160J	C0G	16V	16	± 5%	0.20 ± 0.02
C0402C0G1C180G	C0G	16V	18	± 2%	0.20 ± 0.02
C0402C0G1C180J	C0G	16V	18	± 5%	0.20 ± 0.02
C0402C0G1C200G	C0G	16V	20	± 2%	0.20 ± 0.02
C0402C0G1C200J	C0G	16V	20	± 5%	0.20 ± 0.02
C0402C0G1C220G	C0G	16V	22	± 2%	0.20 ± 0.02
C0402C0G1C220J	C0G	16V	22	± 5%	0.20 ± 0.02
C0402C0G1C240G	C0G	16V	24	± 2%	0.20 ± 0.02
C0402C0G1C240J	C0G	16V	24	± 5%	0.20 ± 0.02
C0402C0G1C270G	C0G	16V	27	± 2%	0.20 ± 0.02
C0402C0G1C270J	C0G	16V	27	± 5%	0.20 ± 0.02
C0402C0G1C300G	C0G	16V	30	± 2%	0.20 ± 0.02
C0402C0G1C300J	C0G	16V	30	± 5%	0.20 ± 0.02
C0402C0G1C330G	C0G	16V	33	± 2%	0.20 ± 0.02
C0402C0G1C330J	C0G	16V	33	± 5%	0.20 ± 0.02
C0402C0G1C360G	C0G	16V	36	± 2%	0.20 ± 0.02
C0402C0G1C360J	C0G	16V	36	± 5%	0.20 ± 0.02
C0402C0G1C390G	C0G	16V	39	± 2%	0.20 ± 0.02
C0402C0G1C390J	C0G	16V	39	± 5%	0.20 ± 0.02
C0402C0G1C430G	C0G	16V	43	± 2%	0.20 ± 0.02
C0402C0G1C430J	C0G	16V	43	± 5%	0.20 ± 0.02
C0402C0G1C470G	C0G	16V	47	± 2%	0.20 ± 0.02
C0402C0G1C470J	C0G	16V	47	± 5%	0.20 ± 0.02
C0402C0G1C510G	C0G	16V	51	± 2%	0.20 ± 0.02
C0402C0G1C510J	C0G	16V	51	± 5%	0.20 ± 0.02
C0402C0G1C560G	C0G	16V	56	± 2%	0.20 ± 0.02
C0402C0G1C560J	C0G	16V	56	± 5%	0.20 ± 0.02
C0402C0G1C620G	C0G	16V	62	± 2%	0.20 ± 0.02
C0402C0G1C620J	C0G	16V	62	± 5%	0.20 ± 0.02
C0402C0G1C680G	C0G	16V	68	± 2%	0.20 ± 0.02
C0402C0G1C680J	C0G	16V	68	± 5%	0.20 ± 0.02
C0402C0G1C750G	C0G	16V	75	± 2%	0.20 ± 0.02
C0402C0G1C750J	C0G	16V	75	± 5%	0.20 ± 0.02



## Capacitance Range Table

# C0402 [EIA CC01005]

### Class 1 (Temperature Compensating)

Temperature Characteristics: C0G (-55 to 125°C, 0±30 ppm/°C)

TDK Part Number (Ordering Code)	Temperature Characteristics	Rated Voltage	Capacitance (pF)	Capacitance Tolerance	Thickness (mm)
C0402C0G1C820G	C0G	16V	82	± 2%	0.20 ± 0.02
C0402C0G1C820J	C0G	16V	82	± 5%	0.20 ± 0.02
C0402C0G1C910G	C0G	16V	91	± 2%	0.20 ± 0.02
C0402C0G1C910J	C0G	16V	91	± 5%	0.20 ± 0.02
C0402C0G1C101G	C0G	16V	100	± 2%	0.20 ± 0.02
C0402C0G1C101J	C0G	16V	100	± 5%	0.20 ± 0.02

### Class 2 (Temperature Stable)

Temperature Characteristics: X7R (-55 to +125°C, ±15%), X5R (-55 to +85°C, ±15%)

TDK Part Number (Ordering Code)	Temperature Characteristics	Rated Voltage	Capacitance (pF)	Capacitance Tolerance	Thickness (mm)
C0402X7R1A101K	X7R	10V	100	± 10%	0.20 ± 0.02
C0402X7R1A151K	X7R	10V	150	± 10%	0.20 ± 0.02
C0402X7R1A221K	X7R	10V	220	± 10%	0.20 ± 0.02
C0402X7R1A331K	X7R	10V	330	± 10%	0.20 ± 0.02
C0402X7R1A471K	X7R	10V	470	± 10%	0.20 ± 0.02
C0402X7R1A681K	X7R	10V	680	± 10%	0.20 ± 0.02
C0402X5R1C101K	X5R	16V	100	± 10%	0.20 ± 0.02
C0402X5R1C151K	X5R	16V	150	± 10%	0.20 ± 0.02
C0402X5R1C221K	X5R	16V	220	± 10%	0.20 ± 0.02
C0402X5R1C331K	X5R	16V	330	± 10%	0.20 ± 0.02
C0402X5R1C471K	X5R	16V	470	± 10%	0.20 ± 0.02
C0402X5R1C681K	X5R	16V	680	± 10%	0.20 ± 0.02
C0402X5R1A101K	X5R	10V	100	± 10%	0.20 ± 0.02
C0402X5R1A221K	X5R	10V	220	± 10%	0.20 ± 0.02
C0402X5R1A471K	X5R	10V	470	± 10%	0.20 ± 0.02
C0402X5R1A102K	X5R	10V	1,000	± 10%	0.20 ± 0.02
C0402X5R1A152K	X5R	10V	1,500	± 10%	0.20 ± 0.02
C0402X5R1A222K	X5R	10V	2,200	± 10%	0.20 ± 0.02
C0402X5R0J681K	X5R	6.3V	680	± 10%	0.20 ± 0.02
C0402X5R0J102K	X5R	6.3V	1,000	± 10%	0.20 ± 0.02
C0402X5R0J152K	X5R	6.3V	1,500	± 10%	0.20 ± 0.02
C0402X5R0J222K	X5R	6.3V	2,200	± 10%	0.20 ± 0.02
C0402X5R0J332K	X5R	6.3V	3,300	± 10%	0.20 ± 0.02
C0402X5R0J472K	X5R	6.3V	4,700	± 10%	0.20 ± 0.02
C0402X5R0J682K	X5R	6.3V	6,800	± 10%	0.20 ± 0.02
C0402X5R0J103K	X5R	6.3V	10,000	± 10%	0.20 ± 0.02



# Capacitance Range Chart

# C0603 [EIA CC0201]

## Capacitance Range Chart

 Temperature Characteristics: C0G ( $0 \pm 30\text{ppm}/^\circ\text{C}$ )

Rated Voltage: 50V (1H), 25V (1E)

Capacitance (pF)	Cap Code	Tolerance	C0G		Capacitance (pF)	Cap Code	Tolerance	C0G	
			1H (50V)	1E (25V)				1H (50V)	1E (25V)
0.2	0R2	W: $\pm 0.05\text{pF}$			6.8	6R8	B: $\pm 0.10\text{pF}$		
0.3	0R3	B: $\pm 0.10\text{pF}$			7.5	7R5	E: $\pm 0.20\text{pF}$		
0.4	0R4	C: $\pm 0.25\text{pF}$			8.2	8R2	C: $\pm 0.25\text{pF}$		
0.5	0R5	D: $\pm 0.50\text{pF}$			9.1	9R1	D: $\pm 0.50\text{pF}$		
0.6	0R6				10	100	G: $\pm 2\%$		
0.7	0R7				11	110	J: $\pm 5\%$		
0.75	R75				12	120			
0.8	0R8				13	130			
0.9	0R9				15	150			
1	010				16	160			
1.1	1R1				18	180			
1.2	1R2				20	200			
1.3	1R3				22	220			
1.5	1R5				24	240			
1.6	1R6				27	270			
1.8	1R8				30	300			
2	020				33	330			
2.2	2R2				36	360			
2.4	2R4				39	390			
2.7	2R7				43	430			
3	030				47	470			
3.3	3R3				51	510			
3.6	3R6				56	560			
3.9	3R9				62	620			
4.3	4R3				68	680			
4.7	4R7				75	750			
5.1	5R1				82	820			
5.6	5R6				91	910			
6.2	6R2				100	101			

Standard Thickness  
 0.30 mm

• Standard capacitance is shown. Please refer to Capacitance Range Table for additional capacitance values.



## Capacitance Range Chart

## C0603 [EIA CC0201]

### Capacitance Range Chart

Temperature Characteristics: X7R ( $\pm 15\%$ ), X5R ( $\pm 15\%$ )  
 Rated Voltage: 50V (1H), 25V (1E), 16V (1C), 10V (1A), 6.3V (0J)

Capacitance (pF)	Cap Code	Tolerance	X7R					X5R				
			1H (50V)	1E (25V)	1C (16V)	1A (10V)	0J (6.3V)	1H (50V)	1E (25V)	1C (16V)	1A (10V)	0J (6.3V)
100	101	K: $\pm 10\%$ M: $\pm 20\%$	█	█	█			█	█			
150	151											
220	221											
330	331											
470	471		█					█				
680	681			█	█				█			
1,000	102											
1,500	152											
2,200	222			█	█					█		
3,300	332											
4,700	472				█					█		
6,800	682											
10,000	103						█			█		
15,000	153											
22,000	223											
33,000	333											
47,000	473											
68,000	683											
100,000	104									█	█	
150,000	154											█
220,000	224											█

• Standard capacitance is shown. Please refer to Capacitance Range Table for additional capacitance values.

Standard Thickness  
 0.30 mm



## Capacitance Range Table

# C0603 [EIA CC0201]

### Class 1 (Temperature Compensating)

Temperature Characteristics: C0G (-55 to 125°C, 0±30 ppm/°C)

TDK Part Number (Ordering Code)	Temperature Characteristics	Rated Voltage	Capacitance (pF)	Capacitance Tolerance	Thickness (mm)
C0603C0G1H0R5B	C0G	50V	0.5	± 0.10pF	0.30 ± 0.03
C0603C0G1H0R5C	C0G	50V	0.5	± 0.25pF	0.30 ± 0.03
C0603C0G1H010B	C0G	50V	1.0	± 0.10pF	0.30 ± 0.03
C0603C0G1H010C	C0G	50V	1.0	± 0.25pF	0.30 ± 0.03
C0603C0G1H1R2C	C0G	50V	1.2	± 0.25pF	0.30 ± 0.03
C0603C0G1H1R5B	C0G	50V	1.5	± 0.10pF	0.30 ± 0.03
C0603C0G1H1R5C	C0G	50V	1.5	± 0.25pF	0.30 ± 0.03
C0603C0G1H1R8C	C0G	50V	1.8	± 0.25pF	0.30 ± 0.03
C0603C0G1H020B	C0G	50V	2.0	± 0.10pF	0.30 ± 0.03
C0603C0G1H020C	C0G	50V	2.0	± 0.25pF	0.30 ± 0.03
C0603C0G1H2R2B	C0G	50V	2.2	± 0.10pF	0.30 ± 0.03
C0603C0G1H2R2C	C0G	50V	2.2	± 0.25pF	0.30 ± 0.03
C0603C0G1H2R7C	C0G	50V	2.7	± 0.25pF	0.30 ± 0.03
C0603C0G1H030B	C0G	50V	3.0	± 0.10pF	0.30 ± 0.03
C0603C0G1H030C	C0G	50V	3.0	± 0.25pF	0.30 ± 0.03
C0603C0G1H3R3B	C0G	50V	3.3	± 0.10pF	0.30 ± 0.03
C0603C0G1H3R3C	C0G	50V	3.3	± 0.25pF	0.30 ± 0.03
C0603C0G1H3R9C	C0G	50V	3.9	± 0.25pF	0.30 ± 0.03
C0603C0G1H040B	C0G	50V	4.0	± 0.10pF	0.30 ± 0.03
C0603C0G1H040C	C0G	50V	4.0	± 0.25pF	0.30 ± 0.03
C0603C0G1H4R7B	C0G	50V	4.7	± 0.10pF	0.30 ± 0.03
C0603C0G1H4R7C	C0G	50V	4.7	± 0.25pF	0.30 ± 0.03
C0603C0G1H050B	C0G	50V	5.0	± 0.10pF	0.30 ± 0.03
C0603C0G1H050C	C0G	50V	5.0	± 0.25pF	0.30 ± 0.03
C0603C0G1H5R6C	C0G	50V	5.6	± 0.25pF	0.30 ± 0.03
C0603C0G1H060C	C0G	50V	6.0	± 0.25pF	0.30 ± 0.03
C0603C0G1H060D	C0G	50V	6.0	± 0.50pF	0.30 ± 0.03
C0603C0G1H6R8C	C0G	50V	6.8	± 0.25pF	0.30 ± 0.03
C0603C0G1H6R8D	C0G	50V	6.8	± 0.50pF	0.30 ± 0.03
C0603C0G1H070C	C0G	50V	7.0	± 0.25pF	0.30 ± 0.03
C0603C0G1H070D	C0G	50V	7.0	± 0.50pF	0.30 ± 0.03
C0603C0G1H080C	C0G	50V	8.0	± 0.25pF	0.30 ± 0.03
C0603C0G1H080D	C0G	50V	8.0	± 0.50pF	0.30 ± 0.03
C0603C0G1H8R2C	C0G	50V	8.2	± 0.25pF	0.30 ± 0.03
C0603C0G1H090C	C0G	50V	9.0	± 0.25pF	0.30 ± 0.03
C0603C0G1H090D	C0G	50V	9.0	± 0.50pF	0.30 ± 0.03
C0603C0G1H100C	C0G	50V	10	± 0.25pF	0.30 ± 0.03
C0603C0G1H100D	C0G	50V	10	± 0.50pF	0.30 ± 0.03
C0603C0G1H110J	C0G	50V	11	± 5%	0.30 ± 0.03
C0603C0G1H120J	C0G	50V	12	± 5%	0.30 ± 0.03
C0603C0G1H130J	C0G	50V	13	± 5%	0.30 ± 0.03
C0603C0G1H150J	C0G	50V	15	± 5%	0.30 ± 0.03
C0603C0G1H160J	C0G	50V	16	± 5%	0.30 ± 0.03
C0603C0G1H180J	C0G	50V	18	± 5%	0.30 ± 0.03



## Capacitance Range Table

# C0603 [EIA CC0201]

### Class 1 (Temperature Compensating)

Temperature Characteristics: C0G (-55 to 125°C, 0±30 ppm/°C)

TDK Part Number (Ordering Code)	Temperature Characteristics	Rated Voltage	Capacitance (pF)	Capacitance Tolerance	Thickness (mm)
C0603C0G1H200J	C0G	50V	20	± 5%	0.30 ± 0.03
C0603C0G1H220J	C0G	50V	22	± 5%	0.30 ± 0.03
C0603C0G1H240J	C0G	50V	24	± 5%	0.30 ± 0.03
C0603C0G1H270J	C0G	50V	27	± 5%	0.30 ± 0.03
C0603C0G1H300J	C0G	50V	30	± 5%	0.30 ± 0.03
C0603C0G1H330J	C0G	50V	33	± 5%	0.30 ± 0.03
C0603C0G1H360J	C0G	50V	36	± 5%	0.30 ± 0.03
C0603C0G1H390J	C0G	50V	39	± 5%	0.30 ± 0.03
C0603C0G1H430J	C0G	50V	43	± 5%	0.30 ± 0.03
C0603C0G1H470J	C0G	50V	47	± 5%	0.30 ± 0.03
C0603C0G1H510J	C0G	50V	51	± 5%	0.30 ± 0.03
C0603C0G1H560J	C0G	50V	56	± 5%	0.30 ± 0.03
C0603C0G1H620J	C0G	50V	62	± 5%	0.30 ± 0.03
C0603C0G1H680J	C0G	50V	68	± 5%	0.30 ± 0.03
C0603C0G1H750J	C0G	50V	75	± 5%	0.30 ± 0.03
C0603C0G1H820J	C0G	50V	82	± 5%	0.30 ± 0.03
C0603C0G1H910J	C0G	50V	91	± 5%	0.30 ± 0.03
C0603C0G1H101J	C0G	50V	100	± 5%	0.30 ± 0.03
C0603C0G1E0R2W	C0G	25V	0.2	± 0.05pF	0.30 ± 0.03
C0603C0G1E0R2B	C0G	25V	0.2	± 0.10pF	0.30 ± 0.03
C0603C0G1E0R3W	C0G	25V	0.3	± 0.05pF	0.30 ± 0.03
C0603C0G1E0R3B	C0G	25V	0.3	± 0.10pF	0.30 ± 0.03
C0603C0G1E0R4W	C0G	25V	0.4	± 0.05pF	0.30 ± 0.03
C0603C0G1E0R4B	C0G	25V	0.4	± 0.10pF	0.30 ± 0.03
C0603C0G1E0R5W	C0G	25V	0.5	± 0.05pF	0.30 ± 0.03
C0603C0G1E0R5C	C0G	25V	0.5	± 0.25pF	0.30 ± 0.03
C0603C0G1E0R5B	C0G	25V	0.5	± 0.10pF	0.30 ± 0.03
C0603C0G1E0R6W	C0G	25V	0.6	± 0.05pF	0.30 ± 0.03
C0603C0G1E0R6B	C0G	25V	0.6	± 0.10pF	0.30 ± 0.03
C0603C0G1E0R7W	C0G	25V	0.7	± 0.05pF	0.30 ± 0.03
C0603C0G1E0R7B	C0G	25V	0.7	± 0.10pF	0.30 ± 0.03
C0603C0G1ER75B	C0G	25V	0.75	± 0.10pF	0.30 ± 0.03
C0603C0G1ER75C	C0G	25V	0.75	± 0.25pF	0.30 ± 0.03
C0603C0G1E0R8W	C0G	25V	0.8	± 0.05pF	0.30 ± 0.03
C0603C0G1E0R8B	C0G	25V	0.8	± 0.10pF	0.30 ± 0.03
C0603C0G1E0R9W	C0G	25V	0.9	± 0.05pF	0.30 ± 0.03
C0603C0G1E0R9B	C0G	25V	0.9	± 0.10pF	0.30 ± 0.03
C0603C0G1E010B	C0G	25V	1.0	± 0.10pF	0.30 ± 0.03
C0603C0G1E010C	C0G	25V	1.0	± 0.25pF	0.30 ± 0.03
C0603C0G1E1R1B	C0G	25V	1.1	± 0.10pF	0.30 ± 0.03
C0603C0G1E1R1C	C0G	25V	1.1	± 0.25pF	0.30 ± 0.03
C0603C0G1E1R2B	C0G	25V	1.2	± 0.10pF	0.30 ± 0.03
C0603C0G1E1R2C	C0G	25V	1.2	± 0.25pF	0.30 ± 0.03
C0603C0G1E1R3B	C0G	25V	1.3	± 0.10pF	0.30 ± 0.03



## Capacitance Range Table

# C0603 [EIA CC0201]

### Class 1 (Temperature Compensating)

Temperature Characteristics: C0G (-55 to 125°C, 0±30 ppm/°C)

TDK Part Number (Ordering Code)	Temperature Characteristics	Rated Voltage	Capacitance (pF)	Capacitance Tolerance	Thickness (mm)
C0603C0G1E1R3C	C0G	25V	1.3	± 0.25pF	0.30 ± 0.03
C0603C0G1E1R5B	C0G	25V	1.5	± 0.10pF	0.30 ± 0.03
C0603C0G1E1R5C	C0G	25V	1.5	± 0.25pF	0.30 ± 0.03
C0603C0G1E1R6B	C0G	25V	1.6	± 0.10pF	0.30 ± 0.03
C0603C0G1E1R6C	C0G	25V	1.6	± 0.25pF	0.30 ± 0.03
C0603C0G1E1R8B	C0G	25V	1.8	± 0.10pF	0.30 ± 0.03
C0603C0G1E1R8C	C0G	25V	1.8	± 0.25pF	0.30 ± 0.03
C0603C0G1E020B	C0G	25V	2.0	± 0.10pF	0.30 ± 0.03
C0603C0G1E020C	C0G	25V	2.0	± 0.25pF	0.30 ± 0.03
C0603C0G1E2R2B	C0G	25V	2.2	± 0.10pF	0.30 ± 0.03
C0603C0G1E2R2C	C0G	25V	2.2	± 0.25pF	0.30 ± 0.03
C0603C0G1E2R4B	C0G	25V	2.4	± 0.10pF	0.30 ± 0.03
C0603C0G1E2R4C	C0G	25V	2.4	± 0.25pF	0.30 ± 0.03
C0603C0G1E2R7B	C0G	25V	2.7	± 0.10pF	0.30 ± 0.03
C0603C0G1E2R7C	C0G	25V	2.7	± 0.25pF	0.30 ± 0.03
C0603C0G1E030B	C0G	25V	3.0	± 0.10pF	0.30 ± 0.03
C0603C0G1E030C	C0G	25V	3.0	± 0.25pF	0.30 ± 0.03
C0603C0G1E3R3B	C0G	25V	3.3	± 0.10pF	0.30 ± 0.03
C0603C0G1E3R3C	C0G	25V	3.3	± 0.25pF	0.30 ± 0.03
C0603C0G1E3R6B	C0G	25V	3.6	± 0.10pF	0.30 ± 0.03
C0603C0G1E3R6C	C0G	25V	3.6	± 0.25pF	0.30 ± 0.03
C0603C0G1E3R9B	C0G	25V	3.9	± 0.10pF	0.30 ± 0.03
C0603C0G1E3R9C	C0G	25V	3.9	± 0.25pF	0.30 ± 0.03
C0603C0G1E040B	C0G	25V	4.0	± 0.10pF	0.30 ± 0.03
C0603C0G1E040C	C0G	25V	4.0	± 0.25pF	0.30 ± 0.03
C0603C0G1E4R3B	C0G	25V	4.3	± 0.10pF	0.30 ± 0.03
C0603C0G1E4R3C	C0G	25V	4.3	± 0.25pF	0.30 ± 0.03
C0603C0G1E4R7B	C0G	25V	4.7	± 0.10pF	0.30 ± 0.03
C0603C0G1E4R7C	C0G	25V	4.7	± 0.25pF	0.30 ± 0.03
C0603C0G1E050B	C0G	25V	5.0	± 0.10pF	0.30 ± 0.03
C0603C0G1E050C	C0G	25V	5.0	± 0.25pF	0.30 ± 0.03
C0603C0G1E5R1B	C0G	25V	5.1	± 0.10pF	0.30 ± 0.03
C0603C0G1E5R1C	C0G	25V	5.1	± 0.25pF	0.30 ± 0.03
C0603C0G1E5R1D	C0G	25V	5.1	± 0.50pF	0.30 ± 0.03
C0603C0G1E5R6B	C0G	25V	5.6	± 0.10pF	0.30 ± 0.03
C0603C0G1E5R6C	C0G	25V	5.6	± 0.25pF	0.30 ± 0.03
C0603C0G1E5R6D	C0G	25V	5.6	± 0.50pF	0.30 ± 0.03
C0603C0G1E060B	C0G	25V	6.0	± 0.10pF	0.30 ± 0.03
C0603C0G1E060C	C0G	25V	6.0	± 0.25pF	0.30 ± 0.03
C0603C0G1E060D	C0G	25V	6.0	± 0.50pF	0.30 ± 0.03
C0603C0G1E6R2B	C0G	25V	6.2	± 0.10pF	0.30 ± 0.03
C0603C0G1E6R2C	C0G	25V	6.2	± 0.25pF	0.30 ± 0.03
C0603C0G1E6R2D	C0G	25V	6.2	± 0.50pF	0.30 ± 0.03
C0603C0G1E6R8B	C0G	25V	6.8	± 0.10pF	0.30 ± 0.03

# C0603 [EIA CC0201]



## Capacitance Range Table

### Class 1 (Temperature Compensating)

Temperature Characteristics: C0G (-55 to 125°C, 0±30 ppm/°C)

TDK Part Number (Ordering Code)	Temperature Characteristics	Rated Voltage	Capacitance (pF)	Capacitance Tolerance	Thickness (mm)
C0603C0G1E6R8C	C0G	25V	6.8	± 0.25pF	0.30 ± 0.03
C0603C0G1E6R8D	C0G	25V	6.8	± 0.50pF	0.30 ± 0.03
C0603C0G1E070B	C0G	25V	7.0	± 0.10pF	0.30 ± 0.03
C0603C0G1E070C	C0G	25V	7.0	± 0.25pF	0.30 ± 0.03
C0603C0G1E070D	C0G	25V	7.0	± 0.50pF	0.30 ± 0.03
C0603C0G1E7R5B	C0G	25V	7.5	± 0.10pF	0.30 ± 0.03
C0603C0G1E7R5C	C0G	25V	7.5	± 0.25pF	0.30 ± 0.03
C0603C0G1E7R5D	C0G	25V	7.5	± 0.50pF	0.30 ± 0.03
C0603C0G1E080B	C0G	25V	8.0	± 0.10pF	0.30 ± 0.03
C0603C0G1E080C	C0G	25V	8.0	± 0.25pF	0.30 ± 0.03
C0603C0G1E080D	C0G	25V	8.0	± 0.50pF	0.30 ± 0.03
C0603C0G1E8R2B	C0G	25V	8.2	± 0.10pF	0.30 ± 0.03
C0603C0G1E8R2C	C0G	25V	8.2	± 0.25pF	0.30 ± 0.03
C0603C0G1E8R2D	C0G	25V	8.2	± 0.50pF	0.30 ± 0.03
C0603C0G1E090B	C0G	25V	9.0	± 0.10pF	0.30 ± 0.03
C0603C0G1E090C	C0G	25V	9.0	± 0.25pF	0.30 ± 0.03
C0603C0G1E090D	C0G	25V	9.0	± 0.50pF	0.30 ± 0.03
C0603C0G1E9R1B	C0G	25V	9.1	± 0.10pF	0.30 ± 0.03
C0603C0G1E9R1C	C0G	25V	9.1	± 0.25pF	0.30 ± 0.03
C0603C0G1E9R1D	C0G	25V	9.1	± 0.50pF	0.30 ± 0.03
C0603C0G1E100E	C0G	25V	10	± 0.20pF	0.30 ± 0.03
C0603C0G1E100C	C0G	25V	10	± 0.25pF	0.30 ± 0.03
C0603C0G1E100D	C0G	25V	10	± 0.50pF	0.30 ± 0.03
C0603C0G1E110G	C0G	25V	11	± 2%	0.30 ± 0.03
C0603C0G1E110J	C0G	25V	11	± 5%	0.30 ± 0.03
C0603C0G1E120G	C0G	25V	12	± 2%	0.30 ± 0.03
C0603C0G1E120J	C0G	25V	12	± 5%	0.30 ± 0.03
C0603C0G1E130G	C0G	25V	13	± 2%	0.30 ± 0.03
C0603C0G1E130J	C0G	25V	13	± 5%	0.30 ± 0.03
C0603C0G1E150G	C0G	25V	15	± 2%	0.30 ± 0.03
C0603C0G1E150J	C0G	25V	15	± 5%	0.30 ± 0.03
C0603C0G1E160G	C0G	25V	16	± 2%	0.30 ± 0.03
C0603C0G1E160J	C0G	25V	16	± 5%	0.30 ± 0.03
C0603C0G1E180G	C0G	25V	18	± 2%	0.30 ± 0.03
C0603C0G1E180J	C0G	25V	18	± 5%	0.30 ± 0.03
C0603C0G1E200G	C0G	25V	20	± 2%	0.30 ± 0.03
C0603C0G1E200J	C0G	25V	20	± 5%	0.30 ± 0.03
C0603C0G1E220G	C0G	25V	22	± 2%	0.30 ± 0.03
C0603C0G1E220J	C0G	25V	22	± 5%	0.30 ± 0.03
C0603C0G1E240G	C0G	25V	24	± 2%	0.30 ± 0.03
C0603C0G1E240J	C0G	25V	24	± 5%	0.30 ± 0.03
C0603C0G1E270G	C0G	25V	27	± 2%	0.30 ± 0.03
C0603C0G1E270J	C0G	25V	27	± 5%	0.30 ± 0.03
C0603C0G1E300G	C0G	25V	30	± 2%	0.30 ± 0.03



## Capacitance Range Table

# C0603 [EIA CC0201]

### Class 1 (Temperature Compensating)

Temperature Characteristics: C0G (-55 to 125°C, 0±30 ppm/°C)

TDK Part Number (Ordering Code)	Temperature Characteristics	Rated Voltage	Capacitance (pF)	Capacitance Tolerance	Thickness (mm)
C0603C0G1E300J	C0G	25V	30	± 5%	0.30 ± 0.03
C0603C0G1E330G	C0G	25V	33	± 2%	0.30 ± 0.03
C0603C0G1E330J	C0G	25V	33	± 5%	0.30 ± 0.03
C0603C0G1E360G	C0G	25V	36	± 2%	0.30 ± 0.03
C0603C0G1E360J	C0G	25V	36	± 5%	0.30 ± 0.03
C0603C0G1E390G	C0G	25V	39	± 2%	0.30 ± 0.03
C0603C0G1E390J	C0G	25V	39	± 5%	0.30 ± 0.03
C0603C0G1E430G	C0G	25V	43	± 2%	0.30 ± 0.03
C0603C0G1E430J	C0G	25V	43	± 5%	0.30 ± 0.03
C0603C0G1E470G	C0G	25V	47	± 2%	0.30 ± 0.03
C0603C0G1E470J	C0G	25V	47	± 5%	0.30 ± 0.03
C0603C0G1E510G	C0G	25V	51	± 2%	0.30 ± 0.03
C0603C0G1E510J	C0G	25V	51	± 5%	0.30 ± 0.03
C0603C0G1E560G	C0G	25V	56	± 2%	0.30 ± 0.03
C0603C0G1E560J	C0G	25V	56	± 5%	0.30 ± 0.03
C0603C0G1E620G	C0G	25V	62	± 2%	0.30 ± 0.03
C0603C0G1E620J	C0G	25V	62	± 5%	0.30 ± 0.03
C0603C0G1E680G	C0G	25V	68	± 2%	0.30 ± 0.03
C0603C0G1E680J	C0G	25V	68	± 5%	0.30 ± 0.03
C0603C0G1E750G	C0G	25V	75	± 2%	0.30 ± 0.03
C0603C0G1E750J	C0G	25V	75	± 5%	0.30 ± 0.03
C0603C0G1E820G	C0G	25V	82	± 2%	0.30 ± 0.03
C0603C0G1E820J	C0G	25V	82	± 5%	0.30 ± 0.03
C0603C0G1E910G	C0G	25V	91	± 2%	0.30 ± 0.03
C0603C0G1E910J	C0G	25V	91	± 5%	0.30 ± 0.03
C0603C0G1E101G	C0G	25V	100	± 2%	0.30 ± 0.03
C0603C0G1E101J	C0G	25V	100	± 5%	0.30 ± 0.03

### Class 2 (Temperature Stable)

Temperature Characteristics: X7R (-55 to +125°C, ±15%)

TDK Part Number (Ordering Code)	Temperature Characteristics	Rated Voltage	Capacitance (pF)	Capacitance Tolerance	Thickness (mm)
C0603X7R1H101K	X7R	50V	100	± 10%	0.30 ± 0.03
C0603X7R1H101M	X7R	50V	100	± 20%	0.30 ± 0.03
C0603X7R1H151K	X7R	50V	150	± 10%	0.30 ± 0.03
C0603X7R1H151M	X7R	50V	150	± 20%	0.30 ± 0.03
C0603X7R1H221K	X7R	50V	220	± 10%	0.30 ± 0.03
C0603X7R1H221M	X7R	50V	220	± 20%	0.30 ± 0.03
C0603X7R1H331K	X7R	50V	330	± 10%	0.30 ± 0.03
C0603X7R1H331M	X7R	50V	330	± 20%	0.30 ± 0.03
C0603X7R1H471K	X7R	50V	470	± 10%	0.30 ± 0.03
C0603X7R1H471M	X7R	50V	470	± 20%	0.30 ± 0.03
C0603X7R1E101K	X7R	25V	100	± 10%	0.30 ± 0.03
C0603X7R1E101M	X7R	25V	100	± 20%	0.30 ± 0.03



## Capacitance Range Table

# C0603 [EIA CC0201]

### Class 2 (Temperature Stable)

Temperature Characteristics: X7R (-55 to +125°C, ±15%)

TDK Part Number (Ordering Code)	Temperature Characteristics	Rated Voltage	Capacitance (pF)	Capacitance Tolerance	Thickness (mm)
C0603X7R1E151K	X7R	25V	150	± 10%	0.30 ± 0.03
C0603X7R1E151M	X7R	25V	150	± 20%	0.30 ± 0.03
C0603X7R1E221K	X7R	25V	220	± 10%	0.30 ± 0.03
C0603X7R1E221M	X7R	25V	220	± 20%	0.30 ± 0.03
C0603X7R1E331K	X7R	25V	330	± 10%	0.30 ± 0.03
C0603X7R1E331M	X7R	25V	330	± 20%	0.30 ± 0.03
C0603X7R1E471K	X7R	25V	470	± 10%	0.30 ± 0.03
C0603X7R1E471M	X7R	25V	470	± 20%	0.30 ± 0.03
C0603X7R1E681K	X7R	25V	680	± 10%	0.30 ± 0.03
C0603X7R1E681M	X7R	25V	680	± 20%	0.30 ± 0.03
C0603X7R1E102K	X7R	25V	1,000	± 10%	0.30 ± 0.03
C0603X7R1E102M	X7R	25V	1,000	± 20%	0.30 ± 0.03
C0603X7R1E152K	X7R	25V	1,500	± 10%	0.30 ± 0.03
C0603X7R1E152M	X7R	25V	1,500	± 20%	0.30 ± 0.03
C0603X7R1E222K	X7R	25V	2,200	± 10%	0.30 ± 0.03
C0603X7R1E222M	X7R	25V	2,200	± 20%	0.30 ± 0.03
C0603X7R1E332K	X7R	25V	3,300	± 10%	0.30 ± 0.03
C0603X7R1E332M	X7R	25V	3,300	± 20%	0.30 ± 0.03
C0603X7R1C101K	X7R	16V	100	± 10%	0.30 ± 0.03
C0603X7R1C101M	X7R	16V	100	± 20%	0.30 ± 0.03
C0603X7R1C151K	X7R	16V	150	± 10%	0.30 ± 0.03
C0603X7R1C151M	X7R	16V	150	± 20%	0.30 ± 0.03
C0603X7R1C221K	X7R	16V	220	± 10%	0.30 ± 0.03
C0603X7R1C221M	X7R	16V	220	± 20%	0.30 ± 0.03
C0603X7R1C331K	X7R	16V	330	± 10%	0.30 ± 0.03
C0603X7R1C331M	X7R	16V	330	± 20%	0.30 ± 0.03
C0603X7R1C471K	X7R	16V	470	± 10%	0.30 ± 0.03
C0603X7R1C471M	X7R	16V	470	± 20%	0.30 ± 0.03
C0603X7R1C681K	X7R	16V	680	± 10%	0.30 ± 0.03
C0603X7R1C681M	X7R	16V	680	± 20%	0.30 ± 0.03
C0603X7R1C102K	X7R	16V	1,000	± 10%	0.30 ± 0.03
C0603X7R1C102M	X7R	16V	1,000	± 20%	0.30 ± 0.03
C0603X7R1C152K	X7R	16V	1,500	± 10%	0.30 ± 0.03
C0603X7R1C152M	X7R	16V	1,500	± 20%	0.30 ± 0.03
C0603X7R1C222K	X7R	16V	2,200	± 10%	0.30 ± 0.03
C0603X7R1C222M	X7R	16V	2,200	± 20%	0.30 ± 0.03
C0603X7R1C332K	X7R	16V	3,300	± 10%	0.30 ± 0.03
C0603X7R1C332M	X7R	16V	3,300	± 20%	0.30 ± 0.03
C0603X7R1C472K	X7R	16V	4,700	± 10%	0.30 ± 0.03
C0603X7R1C472M	X7R	16V	4,700	± 20%	0.30 ± 0.03
C0603X7R1A682K	X7R	10V	6,800	± 10%	0.30 ± 0.03
C0603X7R1A682M	X7R	10V	6,800	± 20%	0.30 ± 0.03
C0603X7R1A103K	X7R	10V	10,000	± 10%	0.30 ± 0.03
C0603X7R1A103M	X7R	10V	10,000	± 20%	0.30 ± 0.03



## Capacitance Range Table

# C0603 [EIA CC0201]

### Class 2 (Temperature Stable)

Temperature Characteristics: X7R (-55 to +125°C, ±15%), X6S(-55 to 105°C, ±22%), X5R (-55 to +85°C, ±15%)

TDK Part Number (Ordering Code)	Temperature Characteristics	Rated Voltage	Capacitance (pF)	Capacitance Tolerance	Thickness (mm)
C0603X7R0J103K	X7R	6.3V	10,000	± 10%	0.30 ± 0.03
C0603X7R0J103M	X7R	6.3V	10,000	± 20%	0.30 ± 0.03
C0603X6S0G104K	X6S	4V	100,000	± 10%	0.30 ± 0.03
C0603X6S0G104M	X6S	4V	100,000	± 20%	0.30 ± 0.03
C0603X5R1H101K	X5R	50V	100	± 10%	0.30 ± 0.03
C0603X5R1H101M	X5R	50V	100	± 20%	0.30 ± 0.03
C0603X5R1H151K	X5R	50V	150	± 10%	0.30 ± 0.03
C0603X5R1H151M	X5R	50V	150	± 20%	0.30 ± 0.03
C0603X5R1H221K	X5R	50V	220	± 10%	0.30 ± 0.03
C0603X5R1H221M	X5R	50V	220	± 20%	0.30 ± 0.03
C0603X5R1H331K	X5R	50V	330	± 10%	0.30 ± 0.03
C0603X5R1H331M	X5R	50V	330	± 20%	0.30 ± 0.03
C0603X5R1H471K	X5R	50V	470	± 10%	0.30 ± 0.03
C0603X5R1H471M	X5R	50V	470	± 20%	0.30 ± 0.03
C0603X5R1E101K	X5R	25V	100	± 10%	0.30 ± 0.03
C0603X5R1E101M	X5R	25V	100	± 20%	0.30 ± 0.03
C0603X5R1E151K	X5R	25V	150	± 10%	0.30 ± 0.03
C0603X5R1E151M	X5R	25V	150	± 20%	0.30 ± 0.03
C0603X5R1E221K	X5R	25V	220	± 10%	0.30 ± 0.03
C0603X5R1E221M	X5R	25V	220	± 20%	0.30 ± 0.03
C0603X5R1E331K	X5R	25V	330	± 10%	0.30 ± 0.03
C0603X5R1E331M	X5R	25V	330	± 20%	0.30 ± 0.03
C0603X5R1E471K	X5R	25V	470	± 10%	0.30 ± 0.03
C0603X5R1E471M	X5R	25V	470	± 20%	0.30 ± 0.03
C0603X5R1E681K	X5R	25V	680	± 10%	0.30 ± 0.03
C0603X5R1E681M	X5R	25V	680	± 20%	0.30 ± 0.03
C0603X5R1E102K	X5R	25V	1,000	± 10%	0.30 ± 0.03
C0603X5R1E102M	X5R	25V	1,000	± 20%	0.30 ± 0.03
C0603X5R1E152K	X5R	25V	1,500	± 10%	0.30 ± 0.03
C0603X5R1E152M	X5R	25V	1,500	± 20%	0.30 ± 0.03
C0603X5R1E222K	X5R	25V	2,200	± 10%	0.30 ± 0.03
C0603X5R1E222M	X5R	25V	2,200	± 20%	0.30 ± 0.03
C0603X5R1E332K	X5R	25V	3,300	± 10%	0.30 ± 0.03
C0603X5R1E332M	X5R	25V	3,300	± 20%	0.30 ± 0.03
C0603X5R1C222K	X5R	16V	2,200	± 10%	0.30 ± 0.03
C0603X5R1C222M	X5R	16V	2,200	± 20%	0.30 ± 0.03
C0603X5R1C332K	X5R	16V	3,300	± 10%	0.30 ± 0.03
C0603X5R1C332M	X5R	16V	3,300	± 20%	0.30 ± 0.03
C0603X5R1C472K	X5R	16V	4,700	± 10%	0.30 ± 0.03
C0603X5R1C472M	X5R	16V	4,700	± 20%	0.30 ± 0.03
C0603X5R1C104K	X5R	16V	100,000	± 10%	0.30 ± 0.03
C0603X5R1C154K	X5R	16V	150,000	± 10%	0.30 ± 0.03
C0603X5R1C224K	X5R	16V	220,000	± 10%	0.30 ± 0.03
C0603X5R1C224M	X5R	16V	220,000	± 20%	0.30 ± 0.03



## Capacitance Range Table

# C0603 [EIA CC0201]

### Class 2 (Temperature Stable)

Temperature Characteristics: X5R (-55 to +85°C, ±15%), Y5V(-30 to +85°C, +22/-82%)

TDK Part Number (Ordering Code)	Temperature Characteristics	Rated Voltage	Capacitance (pF)	Capacitance Tolerance	Thickness (mm)
C0603X5R1A682K	X5R	10V	6,800	± 10%	0.30 ± 0.03
C0603X5R1A682M	X5R	10V	6,800	± 20%	0.30 ± 0.03
C0603X5R1A103K	X5R	10V	10,000	± 10%	0.30 ± 0.03
C0603X5R1A103M	X5R	10V	10,000	± 20%	0.30 ± 0.03
C0603X5R1A104K	X5R	10V	100,000	± 10%	0.30 ± 0.03
C0603X5R1A154K	X5R	10V	150,000	± 10%	0.30 ± 0.03
C0603X5R1A224K	X5R	10V	220,000	± 10%	0.30 ± 0.03
C0603X5R1A224M	X5R	10V	220,000	± 20%	0.30 ± 0.03
C0603X5R0J103K	X5R	6.3V	10,000	± 10%	0.30 ± 0.03
C0603X5R0J103M	X5R	6.3V	10,000	± 20%	0.30 ± 0.03
C0603X5R0J153K	X5R	6.3V	15,000	± 10%	0.30 ± 0.03
C0603X5R0J153M	X5R	6.3V	15,000	± 20%	0.30 ± 0.03
C0603X5R0J223K	X5R	6.3V	22,000	± 10%	0.30 ± 0.03
C0603X5R0J223M	X5R	6.3V	22,000	± 20%	0.30 ± 0.03
C0603X5R0J333K	X5R	6.3V	33,000	± 10%	0.30 ± 0.03
C0603X5R0J333M	X5R	6.3V	33,000	± 20%	0.30 ± 0.03
C0603X5R0J473K	X5R	6.3V	47,000	± 10%	0.30 ± 0.03
C0603X5R0J473M	X5R	6.3V	47,000	± 20%	0.30 ± 0.03
C0603X5R0J683K	X5R	6.3V	68,000	± 10%	0.30 ± 0.03
C0603X5R0J683M	X5R	6.3V	68,000	± 20%	0.30 ± 0.03
C0603X5R0J104K	X5R	6.3V	100,000	± 10%	0.30 ± 0.03
C0603X5R0J104M	X5R	6.3V	100,000	± 20%	0.30 ± 0.03
C0603X5R0J154K	X5R	6.3V	150,000	± 10%	0.30 ± 0.03
C0603X5R0J154M	X5R	6.3V	150,000	± 20%	0.30 ± 0.03
C0603X5R0J224K	X5R	6.3V	220,000	± 10%	0.30 ± 0.03
C0603X5R0J224M	X5R	6.3V	220,000	± 20%	0.30 ± 0.03
C0603Y5V1C103Z	Y5V	16V	10,000	+80/-20%	0.30 ± 0.03



## Capacitance Range Chart

## C1005 [EIA CC0402]

### Capacitance Range Chart

Temperature Characteristics: C0G ( $0 \pm 30\text{ppm}/^\circ\text{C}$ )  
 Rated Voltage: 50V (1H), 25V (1E)

Capacitance (pF)	Cap Code	Tolerance	C0G		Capacitance (pF)	Cap Code	Tolerance	C0G	
			1H (50V)	1E (25V)				1H (50V)	1E (25V)
0.1	0R1	B: $\pm 0.10\text{pF}$ C: $\pm 0.25\text{pF}$ D: $\pm 0.50\text{pF}$			30	300	J: $\pm 5\%$		
0.5	0R5				33	330			
0.75	R75				36	360			
1	010				39	390			
1.2	1R2				43	430			
1.5	1R5				47	470			
1.8	1R8				51	510			
2.2	2R2				56	560			
2.7	2R7				62	620			
3.3	3R3				68	680			
3.9	3R9	C: $\pm 0.25\text{pF}$ D: $\pm 0.50\text{pF}$			75	750			
4.7	4R7				82	820			
5.6	5R6				91	910			
6.8	6R8				100	101			
8.2	8R2				120	121			
10	100				150	151			
11	110			J: $\pm 5\%$			180	181	
12	120						220	221	
13	130						270	271	
15	150						330	331	
16	160		390			391			
18	180		470			471			
20	200		560			561			
22	220		680			681			
24	240		820			821			
27	270		1,000			102			

• Standard capacitance is shown. Please refer to Capacitance Range Table for additional capacitance values.

### Capacitance Range Chart

Temperature Characteristics: X7R ( $\pm 15\%$ )  
 Rated Voltage: 50V (1H), 35V (1V), 25V (1E), 16V(1C), 10V (1A)

Capacitance (pF)	Cap Code	Tolerance	X7R					
			1H (50V)	1V (35V)	1E (25V)	1C (16V)	1A (10V)	
220	221	K: $\pm 10\%$ M: $\pm 20\%$						
330	331							
470	471							
680	681							
1,000	102							
1,500	152							
2,200	222							
3,300	332							
4,700	472							
6,800	682							
10,000	103							
15,000	153							
22,000	223							
33,000	333							
47,000	473							
68,000	683							
100,000	104							
150,000	154							
220,000	224							

Standard Thickness

0.50 mm



# Capacitance Range Chart

## C1005 [EIA CC0402]

### Capacitance Range Chart

Temperature Characteristics: X5R ( $\pm 15\%$ ), X6S ( $\pm 22\%$ ), Y5V (+22/-82%)

Rated Voltage: 50V (1H), 35V (1V), 25V (1E), 16V (1C), 10V (1A), 6.3V (0J), 4V (0G)

Capacitance (pF)	Cap Code	Tolerance	X6S							
			1H (50V)	1V (35V)	1E (25V)	1C (16V)	1A (10V)	0J (6.3V)	0G (4V)	
10,000	103	K: $\pm 10\%$ M: $\pm 20\%$	█							
22,000	223									
47,000	473		█							
100,000	104		█	█						
220,000	224				█	█				
470,000	474						█	█		
1,000,000	105								█	
2,200,000	225									█

Capacitance (pF)	Cap Code	Tolerance	X5R							
			1H (50V)	1V (35V)	1E (25V)	1C (16V)	1A (10V)	0J (6.3V)	0G (4V)	
220	221	K: $\pm 10\%$ M: $\pm 20\%$	█							
330	331									
470	471		█							
680	681		█							
1,000	102		█							
1,500	152		█							
2,200	222		█							
3,300	332		█							
4,700	472		█							
6,800	682		█							
10,000	103				█					
15,000	153				█					
22,000	223				█					
33,000	333				█					
47,000	473		█		█	█				
68,000	683		█		█	█				
100,000	104		█	█	█	█		█		
220,000	224				█	█		█		
330,000	334					█		█		
470,000	474							█		
1,000,000	105								█	
1,500,000	155									█
2,200,000	225									█
3,300,000	335									█
4,700,000	475									█

Capacitance (pF)	Cap Code	Tolerance	Y5V				
			1H (50V)	1E (25V)	1C (16V)	1A (10V)	0J (6.3V)
10,000	103	Z: +80/-20%	█				
100,000	104			█	█		
220,000	224				█	█	
470,000	474					█	
1,000,000	105					█	

Standard Thickness

0.50 mm



## Capacitance Range Table

## C1005 [EIA CC0402]

### Class 1 (Temperature Compensating)

Temperature Characteristics: C0G (-55 to 125°C, 0±30 ppm/°C)

TDK Part Number (Ordering Code)	Temperature Characteristics	Rated Voltage	Capacitance (pF)	Capacitance Tolerance	Thickness (mm)
C1005C0G1H0R5B	C0G	50V	0.5	± 0.10pF	0.50 ± 0.05
C1005C0G1H0R5C	C0G	50V	0.5	± 0.25pF	0.50 ± 0.05
C1005C0G1HR75C	C0G	50V	0.75	± 0.25pF	0.50 ± 0.05
C1005C0G1H010B	C0G	50V	1.0	± 0.10pF	0.50 ± 0.05
C1005C0G1H010C	C0G	50V	1.0	± 0.25pF	0.50 ± 0.05
C1005C0G1H1R2B	C0G	50V	1.2	± 0.10pF	0.50 ± 0.05
C1005C0G1H1R2C	C0G	50V	1.2	± 0.25pF	0.50 ± 0.05
C1005C0G1H1R5B	C0G	50V	1.5	± 0.10pF	0.50 ± 0.05
C1005C0G1H1R5C	C0G	50V	1.5	± 0.25pF	0.50 ± 0.05
C1005C0G1H1R8B	C0G	50V	1.8	± 0.10pF	0.50 ± 0.05
C1005C0G1H1R8C	C0G	50V	1.8	± 0.25pF	0.50 ± 0.05
C1005C0G1H020B	C0G	50V	2.0	± 0.10pF	0.50 ± 0.05
C1005C0G1H020C	C0G	50V	2.0	± 0.25pF	0.50 ± 0.05
C1005C0G1H2R2B	C0G	50V	2.2	± 0.10pF	0.50 ± 0.05
C1005C0G1H2R2C	C0G	50V	2.2	± 0.25pF	0.50 ± 0.05
C1005C0G1H2R5C	C0G	50V	2.5	± 0.25pF	0.50 ± 0.05
C1005C0G1H2R7B	C0G	50V	2.7	± 0.10pF	0.50 ± 0.05
C1005C0G1H2R7C	C0G	50V	2.7	± 0.25pF	0.50 ± 0.05
C1005C0G1H030B	C0G	50V	3.0	± 0.10pF	0.50 ± 0.05
C1005C0G1H030C	C0G	50V	3.0	± 0.25pF	0.50 ± 0.05
C1005C0G1H3R3B	C0G	50V	3.3	± 0.10pF	0.50 ± 0.05
C1005C0G1H3R3C	C0G	50V	3.3	± 0.25pF	0.50 ± 0.05
C1005C0G1H3R5C	C0G	50V	3.5	± 0.25pF	0.50 ± 0.05
C1005C0G1H3R9B	C0G	50V	3.9	± 0.10pF	0.50 ± 0.05
C1005C0G1H3R9C	C0G	50V	3.9	± 0.25pF	0.50 ± 0.05
C1005C0G1H040B	C0G	50V	4.0	± 0.10pF	0.50 ± 0.05
C1005C0G1H040C	C0G	50V	4.0	± 0.25pF	0.50 ± 0.05
C1005C0G1H4R7B	C0G	50V	4.7	± 0.10pF	0.50 ± 0.05
C1005C0G1H4R7C	C0G	50V	4.7	± 0.25pF	0.50 ± 0.05
C1005C0G1H050B	C0G	50V	5.0	± 0.10pF	0.50 ± 0.05
C1005C0G1H050C	C0G	50V	5.0	± 0.25pF	0.50 ± 0.05
C1005C0G1H5R6C	C0G	50V	5.6	± 0.25pF	0.50 ± 0.05
C1005C0G1H5R6D	C0G	50V	5.6	± 0.50pF	0.50 ± 0.05
C1005C0G1H060C	C0G	50V	6.0	± 0.25pF	0.50 ± 0.05
C1005C0G1H060D	C0G	50V	6.0	± 0.50pF	0.50 ± 0.05
C1005C0G1H6R8C	C0G	50V	6.8	± 0.25pF	0.50 ± 0.05
C1005C0G1H6R8D	C0G	50V	6.8	± 0.50pF	0.50 ± 0.05
C1005C0G1H070C	C0G	50V	7.0	± 0.25pF	0.50 ± 0.05
C1005C0G1H070D	C0G	50V	7.0	± 0.50pF	0.50 ± 0.05
C1005C0G1H080C	C0G	50V	8.0	± 0.25pF	0.50 ± 0.05
C1005C0G1H080D	C0G	50V	8.0	± 0.50pF	0.50 ± 0.05
C1005C0G1H8R2C	C0G	50V	8.2	± 0.25pF	0.50 ± 0.05
C1005C0G1H8R2D	C0G	50V	8.2	± 0.50pF	0.50 ± 0.05
C1005C0G1H090C	C0G	50V	9.0	± 0.25pF	0.50 ± 0.05



## Capacitance Range Table

# C1005 [EIA CC0402]

### Class 1 (Temperature Compensating)

Temperature Characteristics: C0G (-55 to 125°C, 0±30 ppm/°C)

TDK Part Number (Ordering Code)	Temperature Characteristics	Rated Voltage	Capacitance (pF)	Capacitance Tolerance	Thickness (mm)
C1005C0G1H090D	C0G	50V	9.0	± 0.50pF	0.50 ± 0.05
C1005C0G1H100C	C0G	50V	10	± 0.25pF	0.50 ± 0.05
C1005C0G1H100D	C0G	50V	10	± 0.50pF	0.50 ± 0.05
C1005C0G1H110J	C0G	50V	11	± 5%	0.50 ± 0.05
C1005C0G1H120J	C0G	50V	12	± 5%	0.50 ± 0.05
C1005C0G1H130J	C0G	50V	13	± 5%	0.50 ± 0.05
C1005C0G1H150J	C0G	50V	15	± 5%	0.50 ± 0.05
C1005C0G1H160J	C0G	50V	16	± 5%	0.50 ± 0.05
C1005C0G1H180J	C0G	50V	18	± 5%	0.50 ± 0.05
C1005C0G1H200J	C0G	50V	20	± 5%	0.50 ± 0.05
C1005C0G1H220J	C0G	50V	22	± 5%	0.50 ± 0.05
C1005C0G1H240J	C0G	50V	24	± 5%	0.50 ± 0.05
C1005C0G1H270J	C0G	50V	27	± 5%	0.50 ± 0.05
C1005C0G1H300J	C0G	50V	30	± 5%	0.50 ± 0.05
C1005C0G1H330J	C0G	50V	33	± 5%	0.50 ± 0.05
C1005C0G1H360J	C0G	50V	36	± 5%	0.50 ± 0.05
C1005C0G1H390J	C0G	50V	39	± 5%	0.50 ± 0.05
C1005C0G1H430J	C0G	50V	43	± 5%	0.50 ± 0.05
C1005C0G1H470J	C0G	50V	47	± 5%	0.50 ± 0.05
C1005C0G1H510J	C0G	50V	51	± 5%	0.50 ± 0.05
C1005C0G1H560J	C0G	50V	56	± 5%	0.50 ± 0.05
C1005C0G1H620J	C0G	50V	62	± 5%	0.50 ± 0.05
C1005C0G1H680J	C0G	50V	68	± 5%	0.50 ± 0.05
C1005C0G1H750J	C0G	50V	75	± 5%	0.50 ± 0.05
C1005C0G1H820J	C0G	50V	82	± 5%	0.50 ± 0.05
C1005C0G1H910J	C0G	50V	91	± 5%	0.50 ± 0.05
C1005C0G1H101J	C0G	50V	100	± 5%	0.50 ± 0.05
C1005C0G1H121J	C0G	50V	120	± 5%	0.50 ± 0.05
C1005C0G1H151J	C0G	50V	150	± 5%	0.50 ± 0.05
C1005C0G1H181J	C0G	50V	180	± 5%	0.50 ± 0.05
C1005C0G1H221J	C0G	50V	220	± 5%	0.50 ± 0.05
C1005C0G1H271J	C0G	50V	270	± 5%	0.50 ± 0.05
C1005C0G1H331J	C0G	50V	330	± 5%	0.50 ± 0.05
C1005C0G1H391J	C0G	50V	390	± 5%	0.50 ± 0.05
C1005C0G1H471J	C0G	50V	470	± 5%	0.50 ± 0.05
C1005C0G1H561J	C0G	50V	560	± 5%	0.50 ± 0.05
C1005C0G1H681J	C0G	50V	680	± 5%	0.50 ± 0.05
C1005C0G1H821J	C0G	50V	820	± 5%	0.50 ± 0.05
C1005C0G1H102J	C0G	50V	1,000	± 5%	0.50 ± 0.05
C1005C0G1E561J	C0G	25V	560	± 5%	0.50 ± 0.05
C1005C0G1E681J	C0G	25V	680	± 5%	0.50 ± 0.05
C1005C0G1E821J	C0G	25V	820	± 5%	0.50 ± 0.05
C1005C0G1E102J	C0G	25V	1,000	± 5%	0.50 ± 0.05



## Capacitance Range Table

# C1005 [EIA CC0402]

### Class 2 (Temperature Stable)

Temperature Characteristics: X7R (-55 to +125°C, ±15%)

TDK Part Number (Ordering Code)	Temperature Characteristics	Rated Voltage	Capacitance (pF)	Capacitance Tolerance	Thickness (mm)
C1005X7R1H221K	X7R	50V	220	± 10%	0.50 ± 0.05
C1005X7R1H221M	X7R	50V	220	± 20%	0.50 ± 0.05
C1005X7R1H331K	X7R	50V	330	± 10%	0.50 ± 0.05
C1005X7R1H331M	X7R	50V	330	± 20%	0.50 ± 0.05
C1005X7R1H471K	X7R	50V	470	± 10%	0.50 ± 0.05
C1005X7R1H471M	X7R	50V	470	± 20%	0.50 ± 0.05
C1005X7R1H681K	X7R	50V	680	± 10%	0.50 ± 0.05
C1005X7R1H681M	X7R	50V	680	± 20%	0.50 ± 0.05
C1005X7R1H102K	X7R	50V	1,000	± 10%	0.50 ± 0.05
C1005X7R1H102M	X7R	50V	1,000	± 20%	0.50 ± 0.05
C1005X7R1H152K	X7R	50V	1,500	± 10%	0.50 ± 0.05
C1005X7R1H152M	X7R	50V	1,500	± 20%	0.50 ± 0.05
C1005X7R1H222K	X7R	50V	2,200	± 10%	0.50 ± 0.05
C1005X7R1H222M	X7R	50V	2,200	± 20%	0.50 ± 0.05
C1005X7R1H332K	X7R	50V	3,300	± 10%	0.50 ± 0.05
C1005X7R1H332M	X7R	50V	3,300	± 20%	0.50 ± 0.05
C1005X7R1H472K	X7R	50V	4,700	± 10%	0.50 ± 0.05
C1005X7R1H472M	X7R	50V	4,700	± 20%	0.50 ± 0.05
C1005X7R1H682K	X7R	50V	6,800	± 10%	0.50 ± 0.05
C1005X7R1H682M	X7R	50V	6,800	± 20%	0.50 ± 0.05
C1005X7R1H103K	X7R	50V	10,000	± 10%	0.50 ± 0.05
C1005X7R1H103M	X7R	50V	10,000	± 20%	0.50 ± 0.05
C1005X7R1H153K	X7R	50V	15,000	± 10%	0.50 ± 0.05
C1005X7R1H153M	X7R	50V	15,000	± 20%	0.50 ± 0.05
C1005X7R1H223K	X7R	50V	22,000	± 10%	0.50 ± 0.05
C1005X7R1H223M	X7R	50V	22,000	± 20%	0.50 ± 0.05
C1005X7R1H333K	X7R	50V	33,000	± 10%	0.50 ± 0.05
C1005X7R1H333M	X7R	50V	33,000	± 20%	0.50 ± 0.05
C1005X7R1H473K	X7R	50V	47,000	± 10%	0.50 ± 0.05
C1005X7R1H473M	X7R	50V	47,000	± 20%	0.50 ± 0.05
C1005X7R1H683K	X7R	50V	68,000	± 10%	0.50 ± 0.05
C1005X7R1H683M	X7R	50V	68,000	± 20%	0.50 ± 0.05
C1005X7R1H104K	X7R	50V	100,000	± 10%	0.50 ± 0.05
C1005X7R1H104M	X7R	50V	100,000	± 20%	0.50 ± 0.05
C1005X7R1V103K	X7R	35V	10,000	± 10%	0.50 ± 0.05
C1005X7R1V103M	X7R	35V	10,000	± 20%	0.50 ± 0.05
C1005X7R1V223K	X7R	35V	22,000	± 10%	0.50 ± 0.05
C1005X7R1V223M	X7R	35V	22,000	± 20%	0.50 ± 0.05
C1005X7R1V473K	X7R	35V	47,000	± 10%	0.50 ± 0.05
C1005X7R1V473M	X7R	35V	47,000	± 20%	0.50 ± 0.05
C1005X7R1V104K	X7R	35V	100,000	± 10%	0.50 ± 0.05
C1005X7R1V104M	X7R	35V	100,000	± 20%	0.50 ± 0.05
C1005X7R1E102K	X7R	25V	1,000	± 10%	0.50 ± 0.05
C1005X7R1E102M	X7R	25V	1,000	± 20%	0.50 ± 0.05



## Capacitance Range Table

## C1005 [EIA CC0402]

### Class 2 (Temperature Stable)

Temperature Characteristics: X7R (-55 to +125°C, ±15%)

TDK Part Number (Ordering Code)	Temperature Characteristics	Rated Voltage	Capacitance (pF)	Capacitance Tolerance	Thickness (mm)
C1005X7R1E152K	X7R	25V	1,500	± 10%	0.50 ± 0.05
C1005X7R1E152M	X7R	25V	1,500	± 20%	0.50 ± 0.05
C1005X7R1E222K	X7R	25V	2,200	± 10%	0.50 ± 0.05
C1005X7R1E222M	X7R	25V	2,200	± 20%	0.50 ± 0.05
C1005X7R1E332K	X7R	25V	3,300	± 10%	0.50 ± 0.05
C1005X7R1E332M	X7R	25V	3,300	± 20%	0.50 ± 0.05
C1005X7R1E472K	X7R	25V	4,700	± 10%	0.50 ± 0.05
C1005X7R1E472M	X7R	25V	4,700	± 20%	0.50 ± 0.05
C1005X7R1E682K	X7R	25V	6,800	± 10%	0.50 ± 0.05
C1005X7R1E682M	X7R	25V	6,800	± 20%	0.50 ± 0.05
C1005X7R1E103J	X7R	25V	10,000	± 5%	0.50 ± 0.05
C1005X7R1E103K	X7R	25V	10,000	± 10%	0.50 ± 0.05
C1005X7R1E103M	X7R	25V	10,000	± 20%	0.50 ± 0.05
C1005X7R1E153K	X7R	25V	15,000	± 10%	0.50 ± 0.05
C1005X7R1E153M	X7R	25V	15,000	± 20%	0.50 ± 0.05
C1005X7R1E223K	X7R	25V	22,000	± 10%	0.50 ± 0.05
C1005X7R1E223M	X7R	25V	22,000	± 20%	0.50 ± 0.05
C1005X7R1E333K	X7R	25V	33,000	± 10%	0.50 ± 0.05
C1005X7R1E333M	X7R	25V	33,000	± 20%	0.50 ± 0.05
C1005X7R1E473K	X7R	25V	47,000	± 10%	0.50 ± 0.05
C1005X7R1E473M	X7R	25V	47,000	± 20%	0.50 ± 0.05
C1005X7R1E683K	X7R	25V	68,000	± 10%	0.50 ± 0.05
C1005X7R1E683M	X7R	25V	68,000	± 20%	0.50 ± 0.05
C1005X7R1E104K	X7R	25V	100,000	± 10%	0.50 ± 0.05
C1005X7R1E104M	X7R	25V	100,000	± 20%	0.50 ± 0.05
C1005X7R1C103K	X7R	16V	10,000	± 10%	0.50 ± 0.05
C1005X7R1C103M	X7R	16V	10,000	± 20%	0.50 ± 0.05
C1005X7R1C153K	X7R	16V	15,000	± 10%	0.50 ± 0.05
C1005X7R1C153M	X7R	16V	15,000	± 20%	0.50 ± 0.05
C1005X7R1C223K	X7R	16V	22,000	± 10%	0.50 ± 0.05
C1005X7R1C223M	X7R	16V	22,000	± 20%	0.50 ± 0.05
C1005X7R1C333K	X7R	16V	33,000	± 10%	0.50 ± 0.05
C1005X7R1C333M	X7R	16V	33,000	± 20%	0.50 ± 0.05
C1005X7R1C473K	X7R	16V	47,000	± 10%	0.50 ± 0.05
C1005X7R1C473M	X7R	16V	47,000	± 20%	0.50 ± 0.05
C1005X7R1C683K	X7R	16V	68,000	± 10%	0.50 ± 0.05
C1005X7R1C683M	X7R	16V	68,000	± 20%	0.50 ± 0.05
C1005X7R1C104K	X7R	16V	100,000	± 10%	0.50 ± 0.05
C1005X7R1C104M	X7R	16V	100,000	± 20%	0.50 ± 0.05
C1005X7R1C154K	X7R	16V	150,000	± 10%	0.50 ± 0.05
C1005X7R1C154M	X7R	16V	150,000	± 20%	0.50 ± 0.05
C1005X7R1C224K	X7R	16V	220,000	± 10%	0.50 ± 0.05
C1005X7R1C224M	X7R	16V	220,000	± 20%	0.50 ± 0.05
C1005X7R1A473K	X7R	10V	47,000	± 10%	0.50 ± 0.05



## Capacitance Range Table

# C1005 [EIA CC0402]

### Class 2 (Temperature Stable)

Temperature Characteristics: X7R (-55 to +125°C, ±15%), X6S(-55 to 105°C, ±22%), X5R (-55 to +85°C, ±15%)

TDK Part Number (Ordering Code)	Temperature Characteristics	Rated Voltage	Capacitance (pF)	Capacitance Tolerance	Thickness (mm)
C1005X7R1A473M	X7R	10V	47,000	± 20%	0.50 ± 0.05
C1005X7R1A683K	X7R	10V	68,000	± 10%	0.50 ± 0.05
C1005X7R1A683M	X7R	10V	68,000	± 20%	0.50 ± 0.05
C1005X7R1A104K	X7R	10V	100,000	± 10%	0.50 ± 0.05
C1005X7R1A104M	X7R	10V	100,000	± 20%	0.50 ± 0.05
C1005X7R1A224K	X7R	10V	220,000	± 10%	0.50 ± 0.05
C1005X7R1A224M	X7R	10V	220,000	± 20%	0.50 ± 0.05
C1005X6S1H103K	X6S	50V	10,000	± 10%	0.50 ± 0.05
C1005X6S1H103M	X6S	50V	10,000	± 20%	0.50 ± 0.05
C1005X6S1H223K	X6S	50V	22,000	± 10%	0.50 ± 0.05
C1005X6S1H223M	X6S	50V	22,000	± 20%	0.50 ± 0.05
C1005X6S1H473K	X6S	50V	47,000	± 10%	0.50 ± 0.05
C1005X6S1H473M	X6S	50V	47,000	± 20%	0.50 ± 0.05
C1005X6S1H104K	X6S	50V	100,000	± 10%	0.50 ± 0.05
C1005X6S1H104M	X6S	50V	100,000	± 20%	0.50 ± 0.05
C1005X6S1V104K	X6S	35V	100,000	± 10%	0.50 ± 0.05
C1005X6S1V104M	X6S	35V	100,000	± 20%	0.50 ± 0.05
C1005X6S1E104K	X6S	25V	100,000	± 10%	0.50 ± 0.05
C1005X6S1E104M	X6S	25V	100,000	± 20%	0.50 ± 0.05
C1005X6S1E224K	X6S	25V	220,000	± 10%	0.50 ± 0.05
C1005X6S1E224M	X6S	25V	220,000	± 20%	0.50 ± 0.05
C1005X6S1C224K	X6S	16V	220,000	± 10%	0.50 ± 0.05
C1005X6S1C224M	X6S	16V	220,000	± 20%	0.50 ± 0.05
C1005X6S1A474K	X6S	10V	470,000	± 10%	0.50 ± 0.05
C1005X6S1A474M	X6S	10V	470,000	± 20%	0.50 ± 0.05
C1005X6S1A105K	X6S	10V	1,000,000	± 10%	0.50 ± 0.05
C1005X6S1A105M	X6S	10V	1,000,000	± 20%	0.50 ± 0.05
C1005X6S0J474K	X6S	6.3V	470,000	± 10%	0.50 ± 0.05
C1005X6S0J474M	X6S	6.3V	470,000	± 20%	0.50 ± 0.05
C1005X6S0J105K	X6S	6.3V	1,000,000	± 10%	0.50 ± 0.05
C1005X6S0J105M	X6S	6.3V	1,000,000	± 20%	0.50 ± 0.05
C1005X6S0G105K	X6S	4V	1,000,000	± 10%	0.50 ± 0.05
C1005X6S0G105M	X6S	4V	1,000,000	± 20%	0.50 ± 0.05
C1005X6S0G225M	X6S	4V	2,200,000	± 20%	0.50 ± 0.05
C1005X5R1H221K	X5R	50V	220	± 10%	0.50 ± 0.05
C1005X5R1H331K	X5R	50V	330	± 10%	0.50 ± 0.05
C1005X5R1H471K	X5R	50V	470	± 10%	0.50 ± 0.05
C1005X5R1H681K	X5R	50V	680	± 10%	0.50 ± 0.05
C1005X5R1H102K	X5R	50V	1,000	± 10%	0.50 ± 0.05
C1005X5R1H152K	X5R	50V	1,500	± 10%	0.50 ± 0.05
C1005X5R1H222K	X5R	50V	2,200	± 10%	0.50 ± 0.05
C1005X5R1H332K	X5R	50V	3,300	± 10%	0.50 ± 0.05
C1005X5R1H472K	X5R	50V	4,700	± 10%	0.50 ± 0.05
C1005X5R1H682K	X5R	50V	6,800	± 10%	0.50 ± 0.05



## Capacitance Range Table

## C1005 [EIA CC0402]

### Class 2 (Temperature Stable)

Temperature Characteristics: X5R (-55 to +85°C, ±15%)

TDK Part Number (Ordering Code)	Temperature Characteristics	Rated Voltage	Capacitance (pF)	Capacitance Tolerance	Thickness (mm)
C1005X5R1H473K	X5R	50V	47,000	± 10%	0.50 ± 0.05
C1005X5R1H473M	X5R	50V	47,000	± 20%	0.50 ± 0.05
C1005X5R1H683K	X5R	50V	68,000	± 10%	0.50 ± 0.05
C1005X5R1H683M	X5R	50V	68,000	± 20%	0.50 ± 0.05
C1005X5R1H104K	X5R	50V	100,000	± 10%	0.50 ± 0.05
C1005X5R1H104M	X5R	50V	100,000	± 20%	0.50 ± 0.05
C1005X5R1V104K	X5R	35V	100,000	± 10%	0.50 ± 0.05
C1005X5R1V104M	X5R	35V	100,000	± 20%	0.50 ± 0.05
C1005X5R1E103K	X5R	25V	10,000	± 10%	0.50 ± 0.05
C1005X5R1E153K	X5R	25V	15,000	± 10%	0.50 ± 0.05
C1005X5R1E223K	X5R	25V	22,000	± 10%	0.50 ± 0.05
C1005X5R1E333K	X5R	25V	33,000	± 10%	0.50 ± 0.05
C1005X5R1E473K	X5R	25V	47,000	± 10%	0.50 ± 0.05
C1005X5R1E473M	X5R	25V	47,000	± 20%	0.50 ± 0.05
C1005X5R1E683K	X5R	25V	68,000	± 10%	0.50 ± 0.05
C1005X5R1E683M	X5R	25V	68,000	± 20%	0.50 ± 0.05
C1005X5R1E104K	X5R	25V	100,000	± 10%	0.50 ± 0.05
C1005X5R1E104M	X5R	25V	100,000	± 20%	0.50 ± 0.05
C1005X5R1E224K	X5R	25V	220,000	± 10%	0.50 ± 0.05
C1005X5R1E224M	X5R	25V	220,000	± 20%	0.50 ± 0.05
C1005X5R1C473K	X5R	16V	47,000	± 10%	0.50 ± 0.05
C1005X5R1C473M	X5R	16V	47,000	± 20%	0.50 ± 0.05
C1005X5R1C683K	X5R	16V	68,000	± 10%	0.50 ± 0.05
C1005X5R1C683M	X5R	16V	68,000	± 20%	0.50 ± 0.05
C1005X5R1C104K	X5R	16V	100,000	± 10%	0.50 ± 0.05
C1005X5R1C104M	X5R	16V	100,000	± 20%	0.50 ± 0.05
C1005X5R1C224K	X5R	16V	220,000	± 10%	0.50 ± 0.05
C1005X5R1C224M	X5R	16V	220,000	± 20%	0.50 ± 0.05
C1005X5R1C334K	X5R	16V	330,000	± 10%	0.50 ± 0.05
C1005X5R1C334M	X5R	16V	330,000	± 20%	0.50 ± 0.05
C1005X5R1C474K	X5R	16V	470,000	± 10%	0.50 ± 0.05
C1005X5R1C474M	X5R	16V	470,000	± 20%	0.50 ± 0.05
C1005X5R1C105K	X5R	16V	1,000,000	± 10%	0.50 ± 0.05
C1005X5R1C105M	X5R	16V	1,000,000	± 20%	0.50 ± 0.05
C1005X5R1A473K	X5R	10V	47,000	± 10%	0.50 ± 0.05
C1005X5R1A473M	X5R	10V	47,000	± 20%	0.50 ± 0.05
C1005X5R1A683K	X5R	10V	68,000	± 10%	0.50 ± 0.05
C1005X5R1A683M	X5R	10V	68,000	± 20%	0.50 ± 0.05
C1005X5R1A104K	X5R	10V	100,000	± 10%	0.50 ± 0.05
C1005X5R1A104M	X5R	10V	100,000	± 20%	0.50 ± 0.05
C1005X5R1A224K	X5R	10V	220,000	± 10%	0.50 ± 0.05
C1005X5R1A224M	X5R	10V	220,000	± 20%	0.50 ± 0.05
C1005X5R1A334K	X5R	10V	330,000	± 10%	0.50 ± 0.05
C1005X5R1A334M	X5R	10V	330,000	± 20%	0.50 ± 0.05



Capacitance Range Table

C1005 [EIA CC0402]

**Class 2 (Temperature Stable)**

Temperature Characteristics: X5R (-55 to +85°C, ±15%), Y5V(-30 to +85°C, +22/-82%)

TDK Part Number (Ordering Code)	Temperature Characteristics	Rated Voltage	Capacitance (pF)	Capacitance Tolerance	Thickness (mm)
C1005X5R1A474K	X5R	10V	470,000	± 10%	0.50 ± 0.05
C1005X5R1A474M	X5R	10V	470,000	± 20%	0.50 ± 0.05
C1005X5R1A105K	X5R	10V	1,000,000	± 10%	0.50 ± 0.05
C1005X5R1A105M	X5R	10V	1,000,000	± 20%	0.50 ± 0.05
C1005X5R1A155K	X5R	10V	1,500,000	± 10%	0.50 ± 0.05
C1005X5R1A155M	X5R	10V	1,500,000	± 20%	0.50 ± 0.05
C1005X5R1A225K	X5R	10V	2,200,000	± 10%	0.50 ± 0.05
C1005X5R1A225M	X5R	10V	2,200,000	± 20%	0.50 ± 0.05
C1005X5R0J104K	X5R	6.3V	100,000	± 10%	0.50 ± 0.05
C1005X5R0J104M	X5R	6.3V	100,000	± 20%	0.50 ± 0.05
C1005X5R0J224K	X5R	6.3V	220,000	± 10%	0.50 ± 0.05
C1005X5R0J224M	X5R	6.3V	220,000	± 20%	0.50 ± 0.05
C1005X5R0J334K	X5R	6.3V	330,000	± 10%	0.50 ± 0.05
C1005X5R0J334M	X5R	6.3V	330,000	± 20%	0.50 ± 0.05
C1005X5R0J474K	X5R	6.3V	470,000	± 10%	0.50 ± 0.05
C1005X5R0J474M	X5R	6.3V	470,000	± 20%	0.50 ± 0.05
C1005X5R0J105K	X5R	6.3V	1,000,000	± 10%	0.50 ± 0.05
C1005X5R0J105M	X5R	6.3V	1,000,000	± 20%	0.50 ± 0.05
C1005X5R0J225K	X5R	6.3V	2,200,000	± 10%	0.50 ± 0.05
C1005X5R0J225M	X5R	6.3V	2,200,000	± 20%	0.50 ± 0.05
C1005X5R0J335K	X5R	6.3V	3,300,000	± 10%	0.50 ± 0.15
C1005X5R0J335M	X5R	6.3V	3,300,000	± 20%	0.50 ± 0.15
C1005X5R0J475K	X5R	6.3V	4,700,000	± 10%	0.50 ± 0.15
C1005X5R0J475M	X5R	6.3V	4,700,000	± 20%	0.50 ± 0.15
C1005X5R0G225K	X5R	4V	2,200,000	± 10%	0.50 ± 0.05
C1005X5R0G225M	X5R	4V	2,200,000	± 20%	0.50 ± 0.05
C1005X5R0G335K	X5R	4V	3,300,000	± 10%	0.50 ± 0.15
C1005X5R0G335M	X5R	4V	3,300,000	± 20%	0.50 ± 0.15
C1005X5R0G475K	X5R	4V	4,700,000	± 10%	0.50 ± 0.15
C1005X5R0G475M	X5R	4V	4,700,000	± 20%	0.50 ± 0.15
C1005Y5V1H103Z	Y5V	50V	10,000	+80/-20%	0.50 ± 0.05
C1005Y5V1E104Z	Y5V	25V	100,000	+80/-20%	0.50 ± 0.05
C1005Y5V1E224Z	Y5V	25V	220,000	+80/-20%	0.50 ± 0.05
C1005Y5V1C104Z	Y5V	16V	100,000	+80/-20%	0.50 ± 0.05
C1005Y5V1C224Z	Y5V	16V	220,000	+80/-20%	0.50 ± 0.05
C1005Y5V1A224Z	Y5V	10V	220,000	+80/-20%	0.50 ± 0.05
C1005Y5V1A474Z	Y5V	10V	470,000	+80/-20%	0.50 ± 0.05
C1005Y5V0J105Z	Y5V	6.3V	1,000,000	+80/-20%	0.50 ± 0.05



## Capacitance Range Chart

## C1608 [EIA CC0603]

### Capacitance Range Chart

Temperature Characteristics: C0G (0 ± 30ppm/°C)  
 Rated Voltage: 50V (1H), 25V (1E)

Capacitance (pF)	Cap Code	Tolerance	C0G	
			1H (50V)	1E (25V)
0.1	0R1	B: ± 0.10pF C: ± 0.25pF		
0.5	0R5			
0.75	R75			
1	010			
1.2	1R2			
1.5	1R5			
1.8	1R8			
2.2	2R2			
2.7	2R7			
3.3	3R3			
3.9	3R9			
4.7	4R7			
5.6	5R6		C: ± 0.25pF D: ± 0.50pF	
6.8	6R8			
8.2	8R2			
10	100	J: ± 5%		
11	110			
12	120			
13	130			
15	150			
16	160			
18	180			
20	200			
22	220			
24	240			
27	270			
30	300			
33	330			
36	360			
39	390			
43	430			
47	470			
51	510			
56	560			
62	620			
68	680			
75	750			
82	820			

Capacitance (pF)	Cap Code	Tolerance	C0G	
			1H (50V)	1E (25V)
91	910	J: ± 5%		
100	101			
110	111			
120	121			
130	131			
150	151			
160	161			
180	181			
200	201			
220	221			
240	241			
270	271			
300	301			
330	331			
360	361			
390	391			
430	431			
470	471			
510	511			
560	561			
620	621			
680	681			
750	751			
820	821			
910	911			
1,000	102			
1,200	122			
1,500	152			
1,800	182			
2,200	222			
2,700	272			
3,300	332			
3,900	392			
4,700	472			
5,600	562			
6,800	682			
8,200	822			
10,000	103			

• Standard capacitance is shown. Please refer to Capacitance Range Table for additional capacitance values.

### Capacitance Range Chart

Temperature Characteristics: X6S (± 22%)  
 Rated Voltage: 50V (1H), 35V (1V), 25V (1E), 16V (1C), 10V (1A), 6.3V (0J), 4V (0G)

Capacitance (pF)	Cap Code	Tolerance	X6S						
			1H (50V)	1V (35V)	1E (25V)	1C (16V)	1A (10V)	0J (6.3V)	0G (4V)
220,000	224	K: ± 10% M: ± 20%							
470,000	474								
1,000,000	105								
2,200,000	225								
4,700,000	475								
10,000,000	106								

Standard Thickness  
 0.80 mm  
 0.50 mm



# Capacitance Range Chart

# C1608 [EIA CC0603]

## Capacitance Range Chart

Temperature Characteristics: X7R ( $\pm 15\%$ ), X5R ( $\pm 15\%$ ), Y5V (+22/-82%)

Rated Voltage: 50V (1H), 35V (1V), 25V (1E), 16V (1C), 10V (1A), 6.3V (0J), 4V (0G)

Capacitance (pF)	Cap Code	Tolerance	X5R								
			1H (50V)	1V (35V)	1E (25V)	1C (16V)	1A (10V)	0J (6.3V)	0G (4V)		
100,000	104	K: $\pm 10\%$ M: $\pm 20\%$	█								
150,000	154										
220,000	224										
330,000	334										
470,000	474										
680,000	684										
1,000,000	105			█	█						
1,500,000	155										
2,200,000	225										
3,300,000	335										
4,700,000	475										
6,800,000	685										
10,000,000	106										█

Capacitance (pF)	Cap Code	Tolerance	X7R								
			1H (50V)	1V (35V)	1E (25V)	1C (16V)	1A (10V)	0J (6.3V)			
100	101	K: $\pm 10\%$ M: $\pm 20\%$	█								
220	221										
330	331										
470	471										
680	681										
1,000	102										
1,500	152										
2,200	222										
3,300	332										
4,700	472										
6,800	682										
10,000	103										
15,000	153										
22,000	223										
33,000	333										
47,000	473										
68,000	683										
100,000	104			█							
150,000	154										
220,000	224										
330,000	334			█							
470,000	474										
680,000	684										
1,000,000	105			█							
2,200,000	225									█	

Capacitance (pF)	Cap Code	Tolerance	Y5V				
			1H (50V)	1E (25V)	1C (16V)	1A (10V)	0J (6.3V)
100,000	104	Z: +80/-20%	█				
220,000	224						
470,000	474						
1,000,000	105						
2,200,000	225						
4,700,000	475						
10,000,000	106						█

Standard Thickness

0.80 mm



Capacitance Range Table

C1608 [EIA CC0603]

**Class 1 (Temperature Compensating)**

Temperature Characteristics: C0G (-55 to 125°C, 0±30 ppm/°C)

TDK Part Number (Ordering Code)	Temperature Characteristics	Rated Voltage	Capacitance (pF)	Capacitance Tolerance	Thickness (mm)
C1608C0G1H0R5B	C0G	50V	0.5	± 0.10pF	0.80 ± 0.10
C1608C0G1H0R5C	C0G	50V	0.5	± 0.25pF	0.80 ± 0.10
C1608C0G1HR75C	C0G	50V	0.75	± 0.25pF	0.80 ± 0.10
C1608C0G1H010B	C0G	50V	1.0	± 0.10pF	0.80 ± 0.10
C1608C0G1H010C	C0G	50V	1.0	± 0.25pF	0.80 ± 0.10
C1608C0G1H1R2B	C0G	50V	1.2	± 0.10pF	0.80 ± 0.10
C1608C0G1H1R2C	C0G	50V	1.2	± 0.25pF	0.80 ± 0.10
C1608C0G1H1R5B	C0G	50V	1.5	± 0.10pF	0.80 ± 0.10
C1608C0G1H1R5C	C0G	50V	1.5	± 0.25pF	0.80 ± 0.10
C1608C0G1H1R8B	C0G	50V	1.8	± 0.10pF	0.80 ± 0.10
C1608C0G1H1R8C	C0G	50V	1.8	± 0.25pF	0.80 ± 0.10
C1608C0G1H020B	C0G	50V	2.0	± 0.10pF	0.80 ± 0.10
C1608C0G1H020C	C0G	50V	2.0	± 0.25pF	0.80 ± 0.10
C1608C0G1H2R2B	C0G	50V	2.2	± 0.10pF	0.80 ± 0.10
C1608C0G1H2R2C	C0G	50V	2.2	± 0.25pF	0.80 ± 0.10
C1608C0G1H2R7B	C0G	50V	2.7	± 0.10pF	0.80 ± 0.10
C1608C0G1H2R7C	C0G	50V	2.7	± 0.25pF	0.80 ± 0.10
C1608C0G1H030B	C0G	50V	3.0	± 0.10pF	0.80 ± 0.10
C1608C0G1H030C	C0G	50V	3.0	± 0.25pF	0.80 ± 0.10
C1608C0G1H3R3B	C0G	50V	3.3	± 0.10pF	0.80 ± 0.10
C1608C0G1H3R3C	C0G	50V	3.3	± 0.25pF	0.80 ± 0.10
C1608C0G1H3R9B	C0G	50V	3.9	± 0.10pF	0.80 ± 0.10
C1608C0G1H3R9C	C0G	50V	3.9	± 0.25pF	0.80 ± 0.10
C1608C0G1H040B	C0G	50V	4.0	± 0.10pF	0.80 ± 0.10
C1608C0G1H040C	C0G	50V	4.0	± 0.25pF	0.80 ± 0.10
C1608C0G1H4R7B	C0G	50V	4.7	± 0.10pF	0.80 ± 0.10
C1608C0G1H4R7C	C0G	50V	4.7	± 0.25pF	0.80 ± 0.10
C1608C0G1H050B	C0G	50V	5.0	± 0.10pF	0.80 ± 0.10
C1608C0G1H050C	C0G	50V	5.0	± 0.25pF	0.80 ± 0.10
C1608C0G1H5R6C	C0G	50V	5.6	± 0.25pF	0.80 ± 0.10
C1608C0G1H5R6D	C0G	50V	5.6	± 0.50pF	0.80 ± 0.10
C1608C0G1H060C	C0G	50V	6.0	± 0.25pF	0.80 ± 0.10
C1608C0G1H060D	C0G	50V	6.0	± 0.50pF	0.80 ± 0.10
C1608C0G1H6R8C	C0G	50V	6.8	± 0.25pF	0.80 ± 0.10
C1608C0G1H6R8D	C0G	50V	6.8	± 0.50pF	0.80 ± 0.10
C1608C0G1H070C	C0G	50V	7.0	± 0.25pF	0.80 ± 0.10
C1608C0G1H070D	C0G	50V	7.0	± 0.50pF	0.80 ± 0.10
C1608C0G1H080C	C0G	50V	8.0	± 0.25pF	0.80 ± 0.10
C1608C0G1H080D	C0G	50V	8.0	± 0.50pF	0.80 ± 0.10
C1608C0G1H8R2C	C0G	50V	8.2	± 0.25pF	0.80 ± 0.10
C1608C0G1H8R2D	C0G	50V	8.2	± 0.50pF	0.80 ± 0.10
C1608C0G1H090C	C0G	50V	9.0	± 0.25pF	0.80 ± 0.10
C1608C0G1H090D	C0G	50V	9.0	± 0.50pF	0.80 ± 0.10
C1608C0G1H100C	C0G	50V	10	± 0.25pF	0.80 ± 0.10



## Capacitance Range Table

## C1608 [EIA CC0603]

### Class 1 (Temperature Compensating)

Temperature Characteristics: C0G (-55 to 125°C, 0±30 ppm/°C)

TDK Part Number (Ordering Code)	Temperature Characteristics	Rated Voltage	Capacitance (pF)	Capacitance Tolerance	Thickness (mm)
C1608C0G1H100D	C0G	50V	10	± 0.50pF	0.80 ± 0.10
C1608C0G1H110J	C0G	50V	11	± 5%	0.80 ± 0.10
C1608C0G1H120J	C0G	50V	12	± 5%	0.80 ± 0.10
C1608C0G1H130J	C0G	50V	13	± 5%	0.80 ± 0.10
C1608C0G1H150J	C0G	50V	15	± 5%	0.80 ± 0.10
C1608C0G1H160J	C0G	50V	16	± 5%	0.80 ± 0.10
C1608C0G1H180J	C0G	50V	18	± 5%	0.80 ± 0.10
C1608C0G1H200J	C0G	50V	20	± 5%	0.80 ± 0.10
C1608C0G1H220J	C0G	50V	22	± 5%	0.80 ± 0.10
C1608C0G1H240J	C0G	50V	24	± 5%	0.80 ± 0.10
C1608C0G1H270J	C0G	50V	27	± 5%	0.80 ± 0.10
C1608C0G1H300J	C0G	50V	30	± 5%	0.80 ± 0.10
C1608C0G1H330J	C0G	50V	33	± 5%	0.80 ± 0.10
C1608C0G1H360J	C0G	50V	36	± 5%	0.80 ± 0.10
C1608C0G1H390J	C0G	50V	39	± 5%	0.80 ± 0.10
C1608C0G1H430J	C0G	50V	43	± 5%	0.80 ± 0.10
C1608C0G1H470J	C0G	50V	47	± 5%	0.80 ± 0.10
C1608C0G1H510J	C0G	50V	51	± 5%	0.80 ± 0.10
C1608C0G1H560J	C0G	50V	56	± 5%	0.80 ± 0.10
C1608C0G1H620J	C0G	50V	62	± 5%	0.80 ± 0.10
C1608C0G1H680J	C0G	50V	68	± 5%	0.80 ± 0.10
C1608C0G1H750J	C0G	50V	75	± 5%	0.80 ± 0.10
C1608C0G1H820J	C0G	50V	82	± 5%	0.80 ± 0.10
C1608C0G1H910J	C0G	50V	91	± 5%	0.80 ± 0.10
C1608C0G1H101J	C0G	50V	100	± 5%	0.80 ± 0.10
C1608C0G1H111J	C0G	50V	110	± 5%	0.80 ± 0.10
C1608C0G1H121J	C0G	50V	120	± 5%	0.80 ± 0.10
C1608C0G1H131J	C0G	50V	130	± 5%	0.80 ± 0.10
C1608C0G1H151J	C0G	50V	150	± 5%	0.80 ± 0.10
C1608C0G1H161J	C0G	50V	160	± 5%	0.80 ± 0.10
C1608C0G1H181J	C0G	50V	180	± 5%	0.80 ± 0.10
C1608C0G1H201J	C0G	50V	200	± 5%	0.80 ± 0.10
C1608C0G1H221J	C0G	50V	220	± 5%	0.80 ± 0.10
C1608C0G1H241J	C0G	50V	240	± 5%	0.80 ± 0.10
C1608C0G1H271J	C0G	50V	270	± 5%	0.80 ± 0.10
C1608C0G1H301J	C0G	50V	300	± 5%	0.80 ± 0.10
C1608C0G1H331J	C0G	50V	330	± 5%	0.80 ± 0.10
C1608C0G1H361J	C0G	50V	360	± 5%	0.80 ± 0.10
C1608C0G1H391J	C0G	50V	390	± 5%	0.80 ± 0.10
C1608C0G1H431J	C0G	50V	430	± 5%	0.80 ± 0.10
C1608C0G1H471J	C0G	50V	470	± 5%	0.80 ± 0.10
C1608C0G1H511J	C0G	50V	510	± 5%	0.80 ± 0.10
C1608C0G1H561J	C0G	50V	560	± 5%	0.80 ± 0.10
C1608C0G1H621J	C0G	50V	620	± 5%	0.80 ± 0.10



## Capacitance Range Table

# C1608 [EIA CC0603]

### Class 1 (Temperature Compensating)

Temperature Characteristics: C0G (-55 to 125°C, 0±30 ppm/°C)

TDK Part Number (Ordering Code)	Temperature Characteristics	Rated Voltage	Capacitance (pF)	Capacitance Tolerance	Thickness (mm)
C1608C0G1H681J	C0G	50V	680	± 5%	0.80 ± 0.10
C1608C0G1H751J	C0G	50V	750	± 5%	0.80 ± 0.10
C1608C0G1H821J	C0G	50V	820	± 5%	0.80 ± 0.10
C1608C0G1H911J	C0G	50V	910	± 5%	0.80 ± 0.10
C1608C0G1H102J	C0G	50V	1,000	± 5%	0.80 ± 0.10
C1608C0G1H122J	C0G	50V	1,200	± 5%	0.80 ± 0.10
C1608C0G1H152J	C0G	50V	1,500	± 5%	0.80 ± 0.10
C1608C0G1H182J	C0G	50V	1,800	± 5%	0.80 ± 0.10
C1608C0G1H222J	C0G	50V	2,200	± 5%	0.80 ± 0.10
C1608C0G1H272J	C0G	50V	2,700	± 5%	0.80 ± 0.10
C1608C0G1H332J	C0G	50V	3,300	± 5%	0.80 ± 0.10
C1608C0G1H392J	C0G	50V	3,900	± 5%	0.80 ± 0.10
C1608C0G1H472J	C0G	50V	4,700	± 5%	0.80 ± 0.10
C1608C0G1H562J	C0G	50V	5,600	± 5%	0.80 ± 0.10
C1608C0G1H682J	C0G	50V	6,800	± 5%	0.80 ± 0.10
C1608C0G1H822J	C0G	50V	8,200	± 5%	0.80 ± 0.10
C1608C0G1H103J	C0G	50V	10,000	± 5%	0.80 ± 0.10
C1608C0G1E392J	C0G	25V	3,900	± 5%	0.80 ± 0.10
C1608C0G1E472J	C0G	25V	4,700	± 5%	0.80 ± 0.10
C1608C0G1E562J	C0G	25V	5,600	± 5%	0.80 ± 0.10
C1608C0G1E682J	C0G	25V	6,800	± 5%	0.80 ± 0.10
C1608C0G1E822J	C0G	25V	8,200	± 5%	0.80 ± 0.10
C1608C0G1E103J	C0G	25V	10,000	± 5%	0.80 ± 0.10

### Class 2 (Temperature Stable)

Temperature Characteristics: X7R (-55 to +125°C, ±15%)

TDK Part Number (Ordering Code)	Temperature Characteristics	Rated Voltage	Capacitance (pF)	Capacitance Tolerance	Thickness (mm)
C1608X7R1H101K	X7R	50V	100	± 10%	0.80 ± 0.10
C1608X7R1H101M	X7R	50V	100	± 20%	0.80 ± 0.10
C1608X7R1H221K	X7R	50V	220	± 10%	0.80 ± 0.10
C1608X7R1H221M	X7R	50V	220	± 20%	0.80 ± 0.10
C1608X7R1H331K	X7R	50V	330	± 10%	0.80 ± 0.10
C1608X7R1H331M	X7R	50V	330	± 20%	0.80 ± 0.10
C1608X7R1H471K	X7R	50V	470	± 10%	0.80 ± 0.10
C1608X7R1H471M	X7R	50V	470	± 20%	0.80 ± 0.10
C1608X7R1H681K	X7R	50V	680	± 10%	0.80 ± 0.10
C1608X7R1H681M	X7R	50V	680	± 20%	0.80 ± 0.10
C1608X7R1H102J	X7R	50V	1,000	± 5%	0.80 ± 0.10
C1608X7R1H102K	X7R	50V	1,000	± 10%	0.80 ± 0.10
C1608X7R1H102M	X7R	50V	1,000	± 20%	0.80 ± 0.10
C1608X7R1H152K	X7R	50V	1,500	± 10%	0.80 ± 0.10
C1608X7R1H152M	X7R	50V	1,500	± 20%	0.80 ± 0.10
C1608X7R1H222K	X7R	50V	2,200	± 10%	0.80 ± 0.10
C1608X7R1H222M	X7R	50V	2,200	± 20%	0.80 ± 0.10



## Capacitance Range Table

## C1608 [EIA CC0603]

### Class 2 (Temperature Stable)

Temperature Characteristics: X7R (-55 to +125°C, ±15%)

TDK Part Number (Ordering Code)	Temperature Characteristics	Rated Voltage	Capacitance (pF)	Capacitance Tolerance	Thickness (mm)
C1608X7R1H332K	X7R	50V	3,300	± 10%	0.80 ± 0.10
C1608X7R1H332M	X7R	50V	3,300	± 20%	0.80 ± 0.10
C1608X7R1H472K	X7R	50V	4,700	± 10%	0.80 ± 0.10
C1608X7R1H472M	X7R	50V	4,700	± 20%	0.80 ± 0.10
C1608X7R1H682K	X7R	50V	6,800	± 10%	0.80 ± 0.10
C1608X7R1H682M	X7R	50V	6,800	± 20%	0.80 ± 0.10
C1608X7R1H103J	X7R	50V	10,000	± 5%	0.80 ± 0.10
C1608X7R1H103K	X7R	50V	10,000	± 10%	0.80 ± 0.10
C1608X7R1H103M	X7R	50V	10,000	± 20%	0.80 ± 0.10
C1608X7R1H153K	X7R	50V	15,000	± 10%	0.80 ± 0.10
C1608X7R1H153M	X7R	50V	15,000	± 20%	0.80 ± 0.10
C1608X7R1H223K	X7R	50V	22,000	± 10%	0.80 ± 0.10
C1608X7R1H223M	X7R	50V	22,000	± 20%	0.80 ± 0.10
C1608X7R1H333K	X7R	50V	33,000	± 10%	0.80 ± 0.10
C1608X7R1H333M	X7R	50V	33,000	± 20%	0.80 ± 0.10
C1608X7R1H473K	X7R	50V	47,000	± 10%	0.80 ± 0.10
C1608X7R1H473M	X7R	50V	47,000	± 20%	0.80 ± 0.10
C1608X7R1H683K	X7R	50V	68,000	± 10%	0.80 ± 0.10
C1608X7R1H683M	X7R	50V	68,000	± 20%	0.80 ± 0.10
C1608X7R1H104K	X7R	50V	100,000	± 10%	0.80 ± 0.10
C1608X7R1H104M	X7R	50V	100,000	± 20%	0.80 ± 0.10
C1608X7R1H154K	X7R	50V	150,000	± 10%	0.80 ± 0.10
C1608X7R1H154M	X7R	50V	150,000	± 20%	0.80 ± 0.10
C1608X7R1H224K	X7R	50V	220,000	± 10%	0.80 ± 0.10
C1608X7R1H224M	X7R	50V	220,000	± 20%	0.80 ± 0.10
C1608X7R1H334K	X7R	50V	330,000	± 10%	0.80 ± 0.10
C1608X7R1H334M	X7R	50V	330,000	± 20%	0.80 ± 0.10
C1608X7R1H474K	X7R	50V	470,000	± 10%	0.80 ± 0.10
C1608X7R1H474M	X7R	50V	470,000	± 20%	0.80 ± 0.10
C1608X7R1V334K	X7R	35V	330,000	± 10%	0.80 ± 0.10
C1608X7R1V334M	X7R	35V	330,000	± 20%	0.80 ± 0.10
C1608X7R1V474K	X7R	35V	470,000	± 10%	0.80 ± 0.10
C1608X7R1V474M	X7R	35V	470,000	± 20%	0.80 ± 0.10
C1608X7R1V105K	X7R	35V	1,000,000	± 10%	0.80 ± 0.10
C1608X7R1V105M	X7R	35V	1,000,000	± 20%	0.80 ± 0.10
C1608X7R1E103J	X7R	25V	10,000	± 5%	0.80 ± 0.10
C1608X7R1E103K	X7R	25V	10,000	± 10%	0.80 ± 0.10
C1608X7R1E103M	X7R	25V	10,000	± 20%	0.80 ± 0.10
C1608X7R1E153K	X7R	25V	15,000	± 10%	0.80 ± 0.10
C1608X7R1E153M	X7R	25V	15,000	± 20%	0.80 ± 0.10
C1608X7R1E223K	X7R	25V	22,000	± 10%	0.80 ± 0.10
C1608X7R1E223M	X7R	25V	22,000	± 20%	0.80 ± 0.10
C1608X7R1E333K	X7R	25V	33,000	± 10%	0.80 ± 0.10
C1608X7R1E333M	X7R	25V	33,000	± 20%	0.80 ± 0.10



Capacitance Range Table

C1608 [EIA CC0603]

**Class 2 (Temperature Stable)**

Temperature Characteristics: X7R (-55 to +125°C, ±15%)

TDK Part Number (Ordering Code)	Temperature Characteristics	Rated Voltage	Capacitance (pF)	Capacitance Tolerance	Thickness (mm)
C1608X7R1E473K	X7R	25V	47,000	± 10%	0.80 ± 0.10
C1608X7R1E473M	X7R	25V	47,000	± 20%	0.80 ± 0.10
C1608X7R1E683K	X7R	25V	68,000	± 10%	0.80 ± 0.10
C1608X7R1E683M	X7R	25V	68,000	± 20%	0.80 ± 0.10
C1608X7R1E104K	X7R	25V	100,000	± 10%	0.80 ± 0.10
C1608X7R1E104M	X7R	25V	100,000	± 20%	0.80 ± 0.10
C1608X7R1E154K	X7R	25V	150,000	± 10%	0.80 ± 0.10
C1608X7R1E154M	X7R	25V	150,000	± 20%	0.80 ± 0.10
C1608X7R1E224K	X7R	25V	220,000	± 10%	0.80 ± 0.10
C1608X7R1E224M	X7R	25V	220,000	± 20%	0.80 ± 0.10
C1608X7R1E334K	X7R	25V	330,000	± 10%	0.80 ± 0.10
C1608X7R1E334M	X7R	25V	330,000	± 20%	0.80 ± 0.10
C1608X7R1E474K	X7R	25V	470,000	± 10%	0.80 ± 0.10
C1608X7R1E474M	X7R	25V	470,000	± 20%	0.80 ± 0.10
C1608X7R1E684K	X7R	25V	680,000	± 10%	0.80 ± 0.10
C1608X7R1E684M	X7R	25V	680,000	± 20%	0.80 ± 0.10
C1608X7R1E105K	X7R	25V	1,000,000	± 10%	0.80 ± 0.10
C1608X7R1E105M	X7R	25V	1,000,000	± 20%	0.80 ± 0.10
C1608X7R1C223K	X7R	16V	22,000	± 10%	0.80 ± 0.10
C1608X7R1C223M	X7R	16V	22,000	± 20%	0.80 ± 0.10
C1608X7R1C333K	X7R	16V	33,000	± 10%	0.80 ± 0.10
C1608X7R1C333M	X7R	16V	33,000	± 20%	0.80 ± 0.10
C1608X7R1C473K	X7R	16V	47,000	± 10%	0.80 ± 0.10
C1608X7R1C473M	X7R	16V	47,000	± 20%	0.80 ± 0.10
C1608X7R1C683K	X7R	16V	68,000	± 10%	0.80 ± 0.10
C1608X7R1C683M	X7R	16V	68,000	± 20%	0.80 ± 0.10
C1608X7R1C104K	X7R	16V	100,000	± 10%	0.80 ± 0.10
C1608X7R1C104M	X7R	16V	100,000	± 20%	0.80 ± 0.10
C1608X7R1C154K	X7R	16V	150,000	± 10%	0.80 ± 0.10
C1608X7R1C154M	X7R	16V	150,000	± 20%	0.80 ± 0.10
C1608X7R1C224K	X7R	16V	220,000	± 10%	0.80 ± 0.10
C1608X7R1C224M	X7R	16V	220,000	± 20%	0.80 ± 0.10
C1608X7R1C334K	X7R	16V	330,000	± 10%	0.80 ± 0.10
C1608X7R1C334M	X7R	16V	330,000	± 20%	0.80 ± 0.10
C1608X7R1C474K	X7R	16V	470,000	± 10%	0.80 ± 0.10
C1608X7R1C474M	X7R	16V	470,000	± 20%	0.80 ± 0.10
C1608X7R1C684K	X7R	16V	680,000	± 10%	0.80 ± 0.10
C1608X7R1C684M	X7R	16V	680,000	± 20%	0.80 ± 0.10
C1608X7R1C105K	X7R	16V	1,000,000	± 10%	0.80 ± 0.10
C1608X7R1C105M	X7R	16V	1,000,000	± 20%	0.80 ± 0.10
C1608X7R1A224K	X7R	10V	220,000	± 10%	0.80 ± 0.10
C1608X7R1A224M	X7R	10V	220,000	± 20%	0.80 ± 0.10
C1608X7R1A334K	X7R	10V	330,000	± 10%	0.80 ± 0.10
C1608X7R1A334M	X7R	10V	330,000	± 20%	0.80 ± 0.10



## Capacitance Range Table

# C1608 [EIA CC0603]

### Class 2 (Temperature Stable)

Temperature Characteristics: X7R (-55 to +125°C, ±15%), X6S (-55 to +105°C, ±22%)

TDK Part Number (Ordering Code)	Temperature Characteristics	Rated Voltage	Capacitance (pF)	Capacitance Tolerance	Thickness (mm)
C1608X7R1A474K	X7R	10V	470,000	± 10%	0.80 ± 0.10
C1608X7R1A474M	X7R	10V	470,000	± 20%	0.80 ± 0.10
C1608X7R1A105K	X7R	10V	1,000,000	± 10%	0.80 ± 0.10
C1608X7R1A105M	X7R	10V	1,000,000	± 20%	0.80 ± 0.10
C1608X7R1A225K	X7R	10V	2,200,000	± 10%	0.80 ± 0.10
C1608X7R1A225M	X7R	10V	2,200,000	± 20%	0.80 ± 0.10
C1608X7R0J225K	X7R	6.3V	2,200,000	± 10%	0.80 ± 0.10
C1608X7R0J225M	X7R	6.3V	2,200,000	± 20%	0.80 ± 0.10
C1608X6S1H224K	X6S	50V	220,000	± 10%	0.80 ± 0.10
C1608X6S1H224M	X6S	50V	220,000	± 20%	0.80 ± 0.10
C1608X6S1H474K	X6S	50V	470,000	± 10%	0.80 ± 0.10
C1608X6S1H474M	X6S	50V	470,000	± 20%	0.80 ± 0.10
C1608X6S1H105K	X6S	50V	1,000,000	± 10%	0.80 ± 0.10
C1608X6S1H105M	X6S	50V	1,000,000	± 20%	0.80 ± 0.10
C1608X6S1V224K	X6S	35V	220,000	± 10%	0.80 ± 0.10
C1608X6S1V224M	X6S	35V	220,000	± 20%	0.80 ± 0.10
C1608X6S1V474K	X6S	35V	470,000	± 10%	0.80 ± 0.10
C1608X6S1V474M	X6S	35V	470,000	± 20%	0.80 ± 0.10
C1608X6S1V105K	X6S	35V	1,000,000	± 10%	0.80 ± 0.10
C1608X6S1V105M	X6S	35V	1,000,000	± 20%	0.80 ± 0.10
C1608X6S1E474K	X6S	25V	470,000	± 10%	0.80 ± 0.10
C1608X6S1E474M	X6S	25V	470,000	± 20%	0.80 ± 0.10
C1608X6S1E105K	X6S	25V	1,000,000	± 10%	0.80 ± 0.10
C1608X6S1E105M	X6S	25V	1,000,000	± 20%	0.80 ± 0.10
C1608X6S1C105K	X6S	16V	1,000,000	± 10%	0.80 ± 0.10
C1608X6S1C105M	X6S	16V	1,000,000	± 20%	0.80 ± 0.10
C1608X6S1C225K	X6S	16V	2,200,000	± 10%	0.80 ± 0.10
C1608X6S1C225M	X6S	16V	2,200,000	± 20%	0.80 ± 0.10
C1608X6S1A225K/0.50	X6S	10V	2,200,000	± 10%	0.50 ± 0.05
C1608X6S1A225M/0.50	X6S	10V	2,200,000	± 20%	0.50 ± 0.05
C1608X6S1A475K	X6S	10V	4,700,000	± 10%	0.80 ± 0.10
C1608X6S1A475M	X6S	10V	4,700,000	± 20%	0.80 ± 0.10
C1608X6S0J225K	X6S	6.3V	2,200,000	± 10%	0.80 ± 0.10
C1608X6S0J225M	X6S	6.3V	2,200,000	± 20%	0.80 ± 0.10
C1608X6S0J475K	X6S	6.3V	4,700,000	± 10%	0.80 ± 0.10
C1608X6S0J475M	X6S	6.3V	4,700,000	± 20%	0.80 ± 0.10
C1608X6S0G225K/0.50	X6S	4V	2,200,000	± 10%	0.50 ± 0.05
C1608X6S0G225M/0.50	X6S	4V	2,200,000	± 20%	0.50 ± 0.05
C1608X6S0G475K/0.50	X6S	4V	4,700,000	± 10%	0.50 ± 0.05
C1608X6S0G475M/0.50	X6S	4V	4,700,000	± 20%	0.50 ± 0.05
C1608X6S0G475K/0.80	X6S	4V	4,700,000	± 10%	0.80 ± 0.10
C1608X6S0G475M/0.80	X6S	4V	4,700,000	± 20%	0.80 ± 0.10
C1608X6S0G106K	X6S	4V	10,000,000	± 10%	0.80 ± 0.10
C1608X6S0G106M	X6S	4V	10,000,000	± 20%	0.80 ± 0.10



## Capacitance Range Table

## C1608 [EIA CC0603]

### Class 2 (Temperature Stable)

Temperature Characteristics: X5R (-55 to +85°C, ±15%)

TDK Part Number (Ordering Code)	Temperature Characteristics	Rated Voltage	Capacitance (pF)	Capacitance Tolerance	Thickness (mm)
C1608X5R1H104K	X5R	50V	100,000	± 10%	0.80 ± 0.10
C1608X5R1H104M	X5R	50V	100,000	± 20%	0.80 ± 0.10
C1608X5R1H154K	X5R	50V	150,000	± 10%	0.80 ± 0.10
C1608X5R1H154M	X5R	50V	150,000	± 20%	0.80 ± 0.10
C1608X5R1H224K	X5R	50V	220,000	± 10%	0.80 ± 0.10
C1608X5R1H224M	X5R	50V	220,000	± 20%	0.80 ± 0.10
C1608X5R1H334K	X5R	50V	330,000	± 10%	0.80 ± 0.10
C1608X5R1H334M	X5R	50V	330,000	± 20%	0.80 ± 0.10
C1608X5R1H474K	X5R	50V	470,000	± 10%	0.80 ± 0.10
C1608X5R1H474M	X5R	50V	470,000	± 20%	0.80 ± 0.10
C1608X5R1H684K	X5R	50V	680,000	± 10%	0.80 ± 0.10
C1608X5R1H684M	X5R	50V	680,000	± 20%	0.80 ± 0.10
C1608X5R1H105K	X5R	50V	1,000,000	± 10%	0.80 ± 0.10
C1608X5R1H105M	X5R	50V	1,000,000	± 20%	0.80 ± 0.10
C1608X5R1V105K	X5R	35V	1,000,000	± 10%	0.80 ± 0.10
C1608X5R1V105M	X5R	35V	1,000,000	± 20%	0.80 ± 0.10
C1608X5R1E154K	X5R	25V	150,000	± 10%	0.80 ± 0.10
C1608X5R1E154M	X5R	25V	150,000	± 20%	0.80 ± 0.10
C1608X5R1E224K	X5R	25V	220,000	± 10%	0.80 ± 0.10
C1608X5R1E224M	X5R	25V	220,000	± 20%	0.80 ± 0.10
C1608X5R1E334K	X5R	25V	330,000	± 10%	0.80 ± 0.10
C1608X5R1E334M	X5R	25V	330,000	± 20%	0.80 ± 0.10
C1608X5R1E474K	X5R	25V	470,000	± 10%	0.80 ± 0.10
C1608X5R1E474M	X5R	25V	470,000	± 20%	0.80 ± 0.10
C1608X5R1E105K	X5R	25V	1,000,000	± 10%	0.80 ± 0.10
C1608X5R1E105M	X5R	25V	1,000,000	± 20%	0.80 ± 0.10
C1608X5R1E155K	X5R	25V	1,500,000	± 10%	0.80 ± 0.10
C1608X5R1E155M	X5R	25V	1,500,000	± 20%	0.80 ± 0.10
C1608X5R1E225K	X5R	25V	2,200,000	± 10%	0.80 ± 0.10
C1608X5R1E225M	X5R	25V	2,200,000	± 20%	0.80 ± 0.10
C1608X5R1C224K	X5R	16V	220,000	± 10%	0.80 ± 0.10
C1608X5R1C224M	X5R	16V	220,000	± 20%	0.80 ± 0.10
C1608X5R1C334K	X5R	16V	330,000	± 10%	0.80 ± 0.10
C1608X5R1C334M	X5R	16V	330,000	± 20%	0.80 ± 0.10
C1608X5R1C474K	X5R	16V	470,000	± 10%	0.80 ± 0.10
C1608X5R1C474M	X5R	16V	470,000	± 20%	0.80 ± 0.10
C1608X5R1C684K	X5R	16V	680,000	± 10%	0.80 ± 0.10
C1608X5R1C684M	X5R	16V	680,000	± 20%	0.80 ± 0.10
C1608X5R1C105K	X5R	16V	1,000,000	± 10%	0.80 ± 0.10
C1608X5R1C105M	X5R	16V	1,000,000	± 20%	0.80 ± 0.10
C1608X5R1C225K/0.50	X5R	16V	2,200,000	± 10%	0.50 ± 0.05
C1608X5R1C225M/0.50	X5R	16V	2,200,000	± 20%	0.50 ± 0.05
C1608X5R1C225K/0.80	X5R	16V	2,200,000	± 10%	0.80 ± 0.10
C1608X5R1C225M/0.80	X5R	16V	2,200,000	± 20%	0.80 ± 0.10



## Capacitance Range Table

# C1608 [EIA CC0603]

### Class 2 (Temperature Stable)

Temperature Characteristics: X5R (-55 to +85°C, ±15%)

TDK Part Number (Ordering Code)	Temperature Characteristics	Rated Voltage	Capacitance (pF)	Capacitance Tolerance	Thickness (mm)
C1608X5R1C335K	X5R	16V	3,300,000	± 10%	0.80 ± 0.10
C1608X5R1C335M	X5R	16V	3,300,000	± 20%	0.80 ± 0.10
C1608X5R1C475K	X5R	16V	4,700,000	± 10%	0.80 ± 0.10
C1608X5R1C475M	X5R	16V	4,700,000	± 20%	0.80 ± 0.10
C1608X5R1A224K	X5R	10V	220,000	± 10%	0.80 ± 0.10
C1608X5R1A224M	X5R	10V	220,000	± 20%	0.80 ± 0.10
C1608X5R1A334K	X5R	10V	330,000	± 10%	0.80 ± 0.10
C1608X5R1A334M	X5R	10V	330,000	± 20%	0.80 ± 0.10
C1608X5R1A474K	X5R	10V	470,000	± 10%	0.80 ± 0.10
C1608X5R1A474M	X5R	10V	470,000	± 20%	0.80 ± 0.10
C1608X5R1A684K	X5R	10V	680,000	± 10%	0.80 ± 0.10
C1608X5R1A684M	X5R	10V	680,000	± 20%	0.80 ± 0.10
C1608X5R1A105K	X5R	10V	1,000,000	± 10%	0.80 ± 0.10
C1608X5R1A105M	X5R	10V	1,000,000	± 20%	0.80 ± 0.10
C1608X5R1A225K/0.50	X5R	10V	2,200,000	± 10%	0.50 ± 0.05
C1608X5R1A225M/0.50	X5R	10V	2,200,000	± 20%	0.50 ± 0.05
C1608X5R1A225K/0.80	X5R	10V	2,200,000	± 10%	0.80 ± 0.10
C1608X5R1A225M/0.80	X5R	10V	2,200,000	± 20%	0.80 ± 0.10
C1608X5R1A335K	X5R	10V	3,300,000	± 10%	0.80 ± 0.10
C1608X5R1A335M	X5R	10V	3,300,000	± 20%	0.80 ± 0.10
C1608X5R1A475K/0.50	X5R	10V	4,700,000	± 10%	0.50 ± 0.05
C1608X5R1A475M/0.50	X5R	10V	4,700,000	± 20%	0.50 ± 0.05
C1608X5R1A475K/0.80	X5R	10V	4,700,000	± 10%	0.80 ± 0.10
C1608X5R1A475M/0.80	X5R	10V	4,700,000	± 20%	0.80 ± 0.10
C1608X5R1A685K	X5R	10V	6,800,000	± 10%	0.80 ± 0.10
C1608X5R1A685M	X5R	10V	6,800,000	± 20%	0.80 ± 0.10
C1608X5R1A106K	X5R	10V	10,000,000	± 10%	0.80 ± 0.10
C1608X5R1A106M	X5R	10V	10,000,000	± 20%	0.80 ± 0.10
C1608X5R0J105K	X5R	6.3V	1,000,000	± 10%	0.80 ± 0.10
C1608X5R0J105M	X5R	6.3V	1,000,000	± 20%	0.80 ± 0.10
C1608X5R0J155K	X5R	6.3V	1,500,000	± 10%	0.80 ± 0.10
C1608X5R0J155M	X5R	6.3V	1,500,000	± 20%	0.80 ± 0.10
C1608X5R0J225K	X5R	6.3V	2,200,000	± 10%	0.80 ± 0.10
C1608X5R0J225M	X5R	6.3V	2,200,000	± 20%	0.80 ± 0.10
C1608X5R0J335K	X5R	6.3V	3,300,000	± 10%	0.80 ± 0.15
C1608X5R0J335M	X5R	6.3V	3,300,000	± 20%	0.80 ± 0.15
C1608X5R0J475K/0.50	X5R	6.3V	4,700,000	± 10%	0.50 ± 0.05
C1608X5R0J475M/0.50	X5R	6.3V	4,700,000	± 20%	0.50 ± 0.05
C1608X5R0J475K/0.80	X5R	6.3V	4,700,000	± 10%	0.80 ± 0.15
C1608X5R0J475M/0.80	X5R	6.3V	4,700,000	± 20%	0.80 ± 0.15
C1608X5R0J685K	X5R	6.3V	6,800,000	± 10%	0.80 ± 0.15
C1608X5R0J685M	X5R	6.3V	6,800,000	± 20%	0.80 ± 0.15
C1608X5R0J106K	X5R	6.3V	10,000,000	± 10%	0.80 ± 0.10
C1608X5R0J106M	X5R	6.3V	10,000,000	± 20%	0.80 ± 0.20



Capacitance Range Table

C1608 [EIA CC0603]

**Class 2 (Temperature Stable)**

Temperature Characteristics: X5R (-55 to +85°C, ±15%), Y5V(-30 to +85°C, +22/-82%)

TDK Part Number (Ordering Code)	Temperature Characteristics	Rated Voltage	Capacitance (pF)	Capacitance Tolerance	Thickness (mm)
C1608X5R0G106M	X5R	4V	10,000,000	± 20%	0.80 ± 0.20
C1608Y5V1H104Z	Y5V	50V	100,000	+80/-20%	0.80 ± 0.10
C1608Y5V1H224Z	Y5V	50V	220,000	+80/-20%	0.80 ± 0.10
C1608Y5V1H474Z	Y5V	50V	470,000	+80/-20%	0.80 ± 0.10
C1608Y5V1E104Z	Y5V	25V	100,000	+80/-20%	0.80 ± 0.10
C1608Y5V1E224Z	Y5V	25V	220,000	+80/-20%	0.80 ± 0.10
C1608Y5V1E474Z	Y5V	25V	470,000	+80/-20%	0.80 ± 0.10
C1608Y5V1E105Z	Y5V	25V	1,000,000	+80/-20%	0.80 ± 0.10
C1608Y5V1C104Z	Y5V	16V	100,000	+80/-20%	0.80 ± 0.10
C1608Y5V1C105Z	Y5V	16V	1,000,000	+80/-20%	0.80 ± 0.10
C1608Y5V1C225Z	Y5V	16V	2,200,000	+80/-20%	0.80 ± 0.10
C1608Y5V1A105Z	Y5V	10V	1,000,000	+80/-20%	0.80 ± 0.10
C1608Y5V1A225Z	Y5V	10V	2,200,000	+80/-20%	0.80 ± 0.10
C1608Y5V0J475Z	Y5V	6.3V	4,700,000	+80/-20%	0.80 ± 0.10
C1608Y5V0J106Z	Y5V	6.3V	10,000,000	+80/-20%	0.80 ± 0.15



## Capacitance Range Chart

## C2012 [EIA CC0805]

### Capacitance Range Chart

Temperature Characteristics: C0G ( $0 \pm 30\text{ppm}/^\circ\text{C}$ )  
 Rated Voltage: 50V (1H), 25V (1E)

Capacitance (pF)	Cap Code	Tolerance	C0G	
			1H (50V)	1E (25V)
10	100	J: $\pm 5\%$	█	
100	101			
120	121			
150	151			
180	181			
220	221			
270	271			
330	331			
390	391			
470	471			
560	561			
680	681			
820	821			
1,000	102			
1,200	122			
1,500	152			
1,800	182			
2,200	222			
2,700	272			
3,300	332			
3,900	392			█
4,700	472			█
5,600	562			█
6,800	682			█
8,200	822			█
10,000	103			█
15,000	153			█
22,000	223			█
33,000	333			█

• Standard capacitance is shown. Please refer to Capacitance Range Table for additional capacitance values.

### Capacitance Range Chart

Temperature Characteristics: X6S ( $\pm 22\%$ )  
 Rated Voltage: 50V (1H), 35V (1V), 25V (1E), 16V (1C), 10V (1A), 6.3V (0J), 4V(0G)

Capacitance (pF)	Cap Code	Tolerance	X6S						
			1H (50V)	1V (35V)	1E (25V)	1C (16V)	1A (10V)	0J (6.3V)	0G (4V)
1,000,000	105	K: $\pm 10\%$ M: $\pm 20\%$	█						
2,200,000	225				█				
4,700,000	475				█				
10,000,000	106					█			
22,000,000	226						█		
47,000,000	476							█	

• Standard thickness is shown. Please refer to Capacitance Range Table for additional thicknesses.

#### Standard Thickness

	0.60 mm
	0.85 mm
	1.25 mm



## Capacitance Range Chart

## C2012 [EIA CC0805]

### Capacitance Range Chart

Temperature Characteristics: X7R ( $\pm 15\%$ ), X5R ( $\pm 15\%$ ), Y5V (+22/-82%)

Rated Voltage: 50V (1H), 35V (1V), 25V (1E), 16V (1C), 10V (1A), 6.3V (0J), 4V (0G)

Capacitance (pF)	Cap Code	Tolerance	X5R					
			1H (50V)	1E (25V)	1C (16V)	1A (10V)	0J (6.3V)	0G (4V)
1,000,000	105	K: $\pm 10\%$ M: $\pm 20\%$	█	█	█	█		
1,500,000	155							
2,200,000	225							
3,300,000	335							
4,700,000	475							
6,800,000	685							
10,000,000	106							
15,000,000	156							
22,000,000	226							
33,000,000	336							
47,000,000	476							█

Capacitance (pF)	Cap Code	Tolerance	X7R					
			1H (50V)	1V (35V)	1E (25V)	1C (16V)	1A (10V)	0J (6.3V)
1,000	102	K: $\pm 10\%$ M: $\pm 20\%$	█					
2,200	222							
4,700	472							
10,000	103							
22,000	223							
47,000	473							
100,000	104					█		
150,000	154							
220,000	224							
330,000	334							
470,000	474							
680,000	684							
1,000,000	105				█			
1,500,000	155							
2,200,000	225							
3,300,000	335							
4,700,000	475							
10,000,000	106						█	

Capacitance (pF)	Cap Code	Tolerance	Y5V				
			1H (50V)	1E (25V)	1C (16V)	1A (10V)	0J (6.3V)
100,000	104	Z: +80/-20%	█				
470,000	474						
1,000,000	105			█			
2,200,000	225						
4,700,000	475					█	
10,000,000	106						█
22,000,000	226						

#### Standard Thickness

	0.60 mm
	0.85 mm
	1.25 mm

• Standard thickness is shown. Please refer to Capacitance Range Table for additional thicknesses.



## Capacitance Range Table

# C2012 [EIA CC0805]

### Class 1 (Temperature Compensating)

Temperature Characteristics: COG (-55 to 125°C, 0±30 ppm/°C)

TDK Part Number (Ordering Code)	Temperature Characteristics	Rated Voltage	Capacitance (pF)	Capacitance Tolerance	Thickness (mm)
C2012C0G1H100D	COG	50V	10	± 0.50pF	0.60 ± 0.10
C2012C0G1H101J	COG	50V	100	± 5%	0.60 ± 0.10
C2012C0G1H121J	COG	50V	120	± 5%	0.60 ± 0.10
C2012C0G1H151J	COG	50V	150	± 5%	0.60 ± 0.10
C2012C0G1H181J	COG	50V	180	± 5%	0.60 ± 0.10
C2012C0G1H221J	COG	50V	220	± 5%	0.60 ± 0.10
C2012C0G1H271J	COG	50V	270	± 5%	0.60 ± 0.10
C2012C0G1H331J	COG	50V	330	± 5%	0.60 ± 0.10
C2012C0G1H391J	COG	50V	390	± 5%	0.60 ± 0.10
C2012C0G1H471J	COG	50V	470	± 5%	0.60 ± 0.10
C2012C0G1H561J	COG	50V	560	± 5%	0.60 ± 0.10
C2012C0G1H681J	COG	50V	680	± 5%	0.60 ± 0.10
C2012C0G1H821J	COG	50V	820	± 5%	0.60 ± 0.10
C2012C0G1H102J	COG	50V	1,000	± 5%	0.60 ± 0.10
C2012C0G1H122J	COG	50V	1,200	± 5%	0.60 ± 0.10
C2012C0G1H152J	COG	50V	1,500	± 5%	0.60 ± 0.10
C2012C0G1H182J/0.60	COG	50V	1,800	± 5%	0.60 ± 0.10
C2012C0G1H182J/0.85	COG	50V	1,800	± 5%	0.85 ± 0.10
C2012C0G1H222J/0.60	COG	50V	2,200	± 5%	0.60 ± 0.10
C2012C0G1H222J/0.85	COG	50V	2,200	± 5%	0.85 ± 0.10
C2012C0G1H272J/0.60	COG	50V	2,700	± 5%	0.60 ± 0.10
C2012C0G1H272J/1.25	COG	50V	2,700	± 5%	1.25 ± 0.20
C2012C0G1H332J/0.60	COG	50V	3,300	± 5%	0.60 ± 0.10
C2012C0G1H332J/1.25	COG	50V	3,300	± 5%	1.25 ± 0.20
C2012C0G1H392J/0.60	COG	50V	3,900	± 5%	0.60 ± 0.10
C2012C0G1H392J/0.85	COG	50V	3,900	± 5%	0.85 ± 0.10
C2012C0G1H472J/0.60	COG	50V	4,700	± 5%	0.60 ± 0.10
C2012C0G1H472J/0.85	COG	50V	4,700	± 5%	0.85 ± 0.10
C2012C0G1H562J/0.60	COG	50V	5,600	± 5%	0.60 ± 0.10
C2012C0G1H562J/0.85	COG	50V	5,600	± 5%	0.85 ± 0.10
C2012C0G1H682J/0.60	COG	50V	6,800	± 5%	0.60 ± 0.10
C2012C0G1H682J/1.25	COG	50V	6,800	± 5%	1.25 ± 0.20
C2012C0G1H822J/0.60	COG	50V	8,200	± 5%	0.60 ± 0.10
C2012C0G1H822J/1.25	COG	50V	8,200	± 5%	1.25 ± 0.20
C2012C0G1H103J/0.60	COG	50V	10,000	± 5%	0.60 ± 0.10
C2012C0G1H103J/1.25	COG	50V	10,000	± 5%	1.25 ± 0.20
C2012C0G1H153J	COG	50V	15,000	± 5%	0.85 ± 0.10
C2012C0G1H223J	COG	50V	22,000	± 5%	1.25 ± 0.20
C2012C0G1H333J	COG	50V	33,000	± 5%	1.25 ± 0.20
C2012C0G1E392J	COG	25V	3,900	± 5%	0.60 ± 0.10
C2012C0G1E472J	COG	25V	4,700	± 5%	0.60 ± 0.10
C2012C0G1E562J	COG	25V	5,600	± 5%	0.60 ± 0.10
C2012C0G1E682J	COG	25V	6,800	± 5%	0.60 ± 0.10
C2012C0G1E822J	COG	25V	8,200	± 5%	0.60 ± 0.10



## Capacitance Range Table

# C2012 [EIA CC0805]

### Class 1 (Temperature Compensating)

Temperature Characteristics: C0G (-55 to 125°C, 0±30 ppm/°C)

TDK Part Number (Ordering Code)	Temperature Characteristics	Rated Voltage	Capacitance (pF)	Capacitance Tolerance	Thickness (mm)
C2012C0G1E103J	C0G	25V	10,000	± 5%	0.60 ± 0.10
C2012C0G1E153J	C0G	25V	15,000	± 5%	0.85 ± 0.10
C2012C0G1E223J	C0G	25V	22,000	± 5%	1.25 ± 0.20
C2012C0G1E333J	C0G	25V	33,000	± 5%	1.25 ± 0.20

### Class 2 (Temperature Stable)

Temperature Characteristics: X7R (-55 to +125°C, ±15%)

TDK Part Number (Ordering Code)	Temperature Characteristics	Rated Voltage	Capacitance (pF)	Capacitance Tolerance	Thickness (mm)
C2012X7R1H102K	X7R	50V	1,000	± 10%	0.60 ± 0.10
C2012X7R1H102M	X7R	50V	1,000	± 20%	0.60 ± 0.10
C2012X7R1H222K	X7R	50V	2,200	± 10%	0.60 ± 0.10
C2012X7R1H222M	X7R	50V	2,200	± 20%	0.60 ± 0.10
C2012X7R1H472K	X7R	50V	4,700	± 10%	0.60 ± 0.10
C2012X7R1H472M	X7R	50V	4,700	± 20%	0.60 ± 0.10
C2012X7R1H103K	X7R	50V	10,000	± 10%	0.60 ± 0.10
C2012X7R1H103M	X7R	50V	10,000	± 20%	0.60 ± 0.10
C2012X7R1H223K/0.60	X7R	50V	22,000	± 10%	0.60 ± 0.10
C2012X7R1H223M/0.60	X7R	50V	22,000	± 20%	0.60 ± 0.10
C2012X7R1H473K/1.25	X7R	50V	47,000	± 10%	1.25 ± 0.20
C2012X7R1H473M/1.25	X7R	50V	47,000	± 20%	1.25 ± 0.20
C2012X7R1H104K/0.85	X7R	50V	100,000	± 10%	0.85 ± 0.10
C2012X7R1H104M/0.85	X7R	50V	100,000	± 20%	0.85 ± 0.10
C2012X7R1H104K/1.25	X7R	50V	100,000	± 10%	1.25 ± 0.20
C2012X7R1H104M/1.25	X7R	50V	100,000	± 20%	1.25 ± 0.20
C2012X7R1H154K	X7R	50V	150,000	± 10%	1.25 ± 0.20
C2012X7R1H154M	X7R	50V	150,000	± 20%	1.25 ± 0.20
C2012X7R1H224K	X7R	50V	220,000	± 10%	1.25 ± 0.20
C2012X7R1H224M	X7R	50V	220,000	± 20%	1.25 ± 0.20
C2012X7R1H334K	X7R	50V	330,000	± 10%	1.25 ± 0.20
C2012X7R1H334M	X7R	50V	330,000	± 20%	1.25 ± 0.20
C2012X7R1H474K	X7R	50V	470,000	± 10%	1.25 ± 0.20
C2012X7R1H474M	X7R	50V	470,000	± 20%	1.25 ± 0.20
C2012X7R1H684K	X7R	50V	680,000	± 10%	1.25 ± 0.20
C2012X7R1H684M	X7R	50V	680,000	± 20%	1.25 ± 0.20
C2012X7R1H105K	X7R	50V	1,000,000	± 10%	1.25 ± 0.20
C2012X7R1H105M	X7R	50V	1,000,000	± 20%	1.25 ± 0.20
C2012X7R1H155K	X7R	50V	1,500,000	± 10%	1.25 ± 0.20
C2012X7R1H155M	X7R	50V	1,500,000	± 20%	1.25 ± 0.20
C2012X7R1H225K	X7R	50V	2,200,000	± 10%	1.25 ± 0.20
C2012X7R1H225M	X7R	50V	2,200,000	± 20%	1.25 ± 0.20
C2012X7R1V105K	X7R	35V	1,000,000	± 10%	1.25 ± 0.20
C2012X7R1V105M	X7R	35V	1,000,000	± 20%	1.25 ± 0.20
C2012X7R1V225K	X7R	35V	2,200,000	± 10%	1.25 ± 0.20
C2012X7R1V225M	X7R	35V	2,200,000	± 20%	1.25 ± 0.20



## Capacitance Range Table

# C2012 [EIA CC0805]

### Class 2 (Temperature Stable)

Temperature Characteristics: X7R (-55 to +125°C, ±15%)

TDK Part Number (Ordering Code)	Temperature Characteristics	Rated Voltage	Capacitance (pF)	Capacitance Tolerance	Thickness (mm)
C2012X7R1V335K	X7R	35V	3,300,000	± 10%	1.25 ± 0.20
C2012X7R1V335M	X7R	35V	3,300,000	± 20%	1.25 ± 0.20
C2012X7R1V475K	X7R	35V	4,700,000	± 10%	1.25 ± 0.20
C2012X7R1V475M	X7R	35V	4,700,000	± 20%	1.25 ± 0.20
C2012X7R1E104K/0.85	X7R	25V	100,000	± 10%	0.85 ± 0.10
C2012X7R1E104M/0.85	X7R	25V	100,000	± 20%	0.85 ± 0.10
C2012X7R1E104K/1.25	X7R	25V	100,000	± 10%	1.25 ± 0.20
C2012X7R1E104M/1.25	X7R	25V	100,000	± 20%	1.25 ± 0.20
C2012X7R1E224K	X7R	25V	220,000	± 10%	1.25 ± 0.20
C2012X7R1E224M	X7R	25V	220,000	± 20%	1.25 ± 0.20
C2012X7R1E334K	X7R	25V	330,000	± 10%	1.25 ± 0.20
C2012X7R1E334M	X7R	25V	330,000	± 20%	1.25 ± 0.20
C2012X7R1E474K	X7R	25V	470,000	± 10%	1.25 ± 0.20
C2012X7R1E474M	X7R	25V	470,000	± 20%	1.25 ± 0.20
C2012X7R1E684K	X7R	25V	680,000	± 10%	1.25 ± 0.20
C2012X7R1E684M	X7R	25V	680,000	± 20%	1.25 ± 0.20
C2012X7R1E105K	X7R	25V	1,000,000	± 10%	1.25 ± 0.20
C2012X7R1E105M	X7R	25V	1,000,000	± 20%	1.25 ± 0.20
C2012X7R1E155K	X7R	25V	1,500,000	± 10%	1.25 ± 0.20
C2012X7R1E155M	X7R	25V	1,500,000	± 20%	1.25 ± 0.20
C2012X7R1E225K	X7R	25V	2,200,000	± 10%	1.25 ± 0.20
C2012X7R1E225M	X7R	25V	2,200,000	± 20%	1.25 ± 0.20
C2012X7R1E335K	X7R	25V	3,300,000	± 10%	1.25 ± 0.20
C2012X7R1E335M	X7R	25V	3,300,000	± 20%	1.25 ± 0.20
C2012X7R1E475K	X7R	25V	4,700,000	± 10%	1.25 ± 0.20
C2012X7R1E475M	X7R	25V	4,700,000	± 20%	1.25 ± 0.20
C2012X7R1C224K	X7R	16V	220,000	± 10%	1.25 ± 0.20
C2012X7R1C224M	X7R	16V	220,000	± 20%	1.25 ± 0.20
C2012X7R1C334K/1.25	X7R	16V	330,000	± 10%	1.25 ± 0.20
C2012X7R1C334M/1.25	X7R	16V	330,000	± 20%	1.25 ± 0.20
C2012X7R1C474K	X7R	16V	470,000	± 10%	1.25 ± 0.20
C2012X7R1C474M	X7R	16V	470,000	± 20%	1.25 ± 0.20
C2012X7R1C684K	X7R	16V	680,000	± 10%	1.25 ± 0.20
C2012X7R1C684M	X7R	16V	680,000	± 20%	1.25 ± 0.20
C2012X7R1C105K/0.85	X7R	16V	1,000,000	± 10%	0.85 ± 0.10
C2012X7R1C105M/0.85	X7R	16V	1,000,000	± 20%	0.85 ± 0.10
C2012X7R1C105K/1.25	X7R	16V	1,000,000	± 10%	1.25 ± 0.20
C2012X7R1C105M/1.25	X7R	16V	1,000,000	± 20%	1.25 ± 0.20
C2012X7R1C155K	X7R	16V	1,500,000	± 10%	1.25 ± 0.20
C2012X7R1C155M	X7R	16V	1,500,000	± 20%	1.25 ± 0.20
C2012X7R1C225K	X7R	16V	2,200,000	± 10%	1.25 ± 0.20
C2012X7R1C225M	X7R	16V	2,200,000	± 20%	1.25 ± 0.20
C2012X7R1C335K	X7R	16V	3,300,000	± 10%	1.25 ± 0.20
C2012X7R1C335M	X7R	16V	3,300,000	± 20%	1.25 ± 0.20



## Capacitance Range Table

# C2012 [EIA CC0805]

### Class 2 (Temperature Stable)

Temperature Characteristics: X7R (-55 to +125°C, ±15%), X6S(-55 to 105°C, ±22%)

TDK Part Number (Ordering Code)	Temperature Characteristics	Rated Voltage	Capacitance (pF)	Capacitance Tolerance	Thickness (mm)
C2012X7R1C475K	X7R	16V	4,700,000	± 10%	1.25 ± 0.20
C2012X7R1C475M	X7R	16V	4,700,000	± 20%	1.25 ± 0.20
C2012X7R1A105K	X7R	10V	1,000,000	± 10%	1.25 ± 0.20
C2012X7R1A105M	X7R	10V	1,000,000	± 20%	1.25 ± 0.20
C2012X7R1A155K	X7R	10V	1,500,000	± 10%	1.25 ± 0.20
C2012X7R1A155M	X7R	10V	1,500,000	± 20%	1.25 ± 0.20
C2012X7R1A225K	X7R	10V	2,200,000	± 10%	1.25 ± 0.20
C2012X7R1A225M	X7R	10V	2,200,000	± 20%	1.25 ± 0.20
C2012X7R1A335K	X7R	10V	3,300,000	± 10%	1.25 ± 0.20
C2012X7R1A335M	X7R	10V	3,300,000	± 20%	1.25 ± 0.20
C2012X7R1A475K	X7R	10V	4,700,000	± 10%	1.25 ± 0.20
C2012X7R1A475M	X7R	10V	4,700,000	± 20%	1.25 ± 0.20
C2012X7R1A106K	X7R	10V	10,000,000	± 10%	1.25 ± 0.20
C2012X7R1A106M	X7R	10V	10,000,000	± 20%	1.25 ± 0.20
C2012X7R0J106K	X7R	6.3V	10,000,000	± 10%	1.25 ± 0.20
C2012X7R0J106M	X7R	6.3V	10,000,000	± 20%	1.25 ± 0.20
C2012X6S1H105K	X6S	50V	1,000,000	± 10%	1.25 ± 0.20
C2012X6S1H105M	X6S	50V	1,000,000	± 20%	1.25 ± 0.20
C2012X6S1H225K	X6S	50V	2,200,000	± 10%	1.25 ± 0.20
C2012X6S1H225M	X6S	50V	2,200,000	± 20%	1.25 ± 0.20
C2012X6S1H475K	X6S	50V	4,700,000	± 10%	1.25 ± 0.20
C2012X6S1H475M	X6S	50V	4,700,000	± 20%	1.25 ± 0.20
C2012X6S1V475K	X6S	35V	4,700,000	± 10%	1.25 ± 0.20
C2012X6S1V475M	X6S	35V	4,700,000	± 20%	1.25 ± 0.20
C2012X6S1E225K	X6S	25V	2,200,000	± 10%	1.25 ± 0.20
C2012X6S1E225M	X6S	25V	2,200,000	± 20%	1.25 ± 0.20
C2012X6S1E475K	X6S	25V	4,700,000	± 10%	1.25 ± 0.20
C2012X6S1E475M	X6S	25V	4,700,000	± 20%	1.25 ± 0.20
C2012X6S1C225K	X6S	16V	2,200,000	± 10%	0.90 +0.05,-0.10
C2012X6S1C225M	X6S	16V	2,200,000	± 20%	0.90 +0.05,-0.10
C2012X6S1C475K	X6S	16V	4,700,000	± 10%	1.25 ± 0.20
C2012X6S1C475M	X6S	16V	4,700,000	± 20%	1.25 ± 0.20
C2012X6S1C106K	X6S	16V	10,000,000	± 10%	1.25 ± 0.20
C2012X6S1C106M	X6S	16V	10,000,000	± 20%	1.25 ± 0.20
C2012X6S1A106K/0.85	X6S	10V	10,000,000	± 10%	0.85 ± 0.10
C2012X6S1A106M/0.85	X6S	10V	10,000,000	± 20%	0.85 ± 0.10
C2012X6S1A226K	X6S	10V	22,000,000	± 10%	1.25 ± 0.20
C2012X6S1A226M	X6S	10V	22,000,000	± 20%	1.25 ± 0.20
C2012X6S0J106K	X6S	6.3V	10,000,000	± 10%	0.85 ± 0.10
C2012X6S0J106M	X6S	6.3V	10,000,000	± 20%	0.85 ± 0.10
C2012X6S0J226K	X6S	6.3V	22,000,000	± 10%	1.25 ± 0.20
C2012X6S0J226M	X6S	6.3V	22,000,000	± 20%	1.25 ± 0.20
C2012X6S0G226M	X6S	4V	22,000,000	± 20%	0.85 ± 0.10
C2012X6S0G476M	X6S	4V	47,000,000	± 20%	1.25 ± 0.20



## Capacitance Range Table

# C2012 [EIA CC0805]

### Class 2 (Temperature Stable)

Temperature Characteristics: X5R (-55 to +85°C, ±15%)

TDK Part Number (Ordering Code)	Temperature Characteristics	Rated Voltage	Capacitance (pF)	Capacitance Tolerance	Thickness (mm)
C2012X5R1H105K	X5R	50V	1,000,000	± 10%	1.25 ± 0.20
C2012X5R1H105M	X5R	50V	1,000,000	± 20%	1.25 ± 0.20
C2012X5R1H155K	X5R	50V	1,500,000	± 10%	1.25 ± 0.20
C2012X5R1H155M	X5R	50V	1,500,000	± 20%	1.25 ± 0.20
C2012X5R1H225K	X5R	50V	2,200,000	± 10%	1.25 ± 0.20
C2012X5R1H225M	X5R	50V	2,200,000	± 20%	1.25 ± 0.20
C2012X5R1H335K	X5R	50V	3,300,000	± 10%	1.25 ± 0.20
C2012X5R1H335M	X5R	50V	3,300,000	± 20%	1.25 ± 0.20
C2012X5R1H475K	X5R	50V	4,700,000	± 10%	1.25 ± 0.20
C2012X5R1H475M	X5R	50V	4,700,000	± 20%	1.25 ± 0.20
C2012X5R1E105K/0.85	X5R	25V	1,000,000	± 10%	0.85 ± 0.10
C2012X5R1E105M/0.85	X5R	25V	1,000,000	± 20%	0.85 ± 0.10
C2012X5R1E105K/1.25	X5R	25V	1,000,000	± 10%	1.25 ± 0.20
C2012X5R1E105M/1.25	X5R	25V	1,000,000	± 20%	1.25 ± 0.20
C2012X5R1E155K	X5R	25V	1,500,000	± 10%	1.25 ± 0.20
C2012X5R1E155M	X5R	25V	1,500,000	± 20%	1.25 ± 0.20
C2012X5R1E225K	X5R	25V	2,200,000	± 10%	1.25 ± 0.20
C2012X5R1E225M	X5R	25V	2,200,000	± 20%	1.25 ± 0.20
C2012X5R1E475K	X5R	25V	4,700,000	± 10%	1.25 ± 0.20
C2012X5R1E475M	X5R	25V	4,700,000	± 20%	1.25 ± 0.20
C2012X5R1E685K	X5R	25V	6,800,000	± 10%	1.25 ± 0.20
C2012X5R1E685M	X5R	25V	6,800,000	± 20%	1.25 ± 0.20
C2012X5R1E106K	X5R	25V	10,000,000	± 10%	1.25 ± 0.20
C2012X5R1E106M	X5R	25V	10,000,000	± 20%	1.25 ± 0.20
C2012X5R1C105K/0.85	X5R	16V	1,000,000	± 10%	0.85 ± 0.10
C2012X5R1C105M/0.85	X5R	16V	1,000,000	± 20%	0.85 ± 0.10
C2012X5R1C105K/1.25	X5R	16V	1,000,000	± 10%	1.25 ± 0.20
C2012X5R1C105M/1.25	X5R	16V	1,000,000	± 20%	1.25 ± 0.20
C2012X5R1C225K/0.85	X5R	16V	2,200,000	± 10%	0.85 ± 0.10
C2012X5R1C225M/0.85	X5R	16V	2,200,000	± 20%	0.85 ± 0.10
C2012X5R1C225K/1.25	X5R	16V	2,200,000	± 10%	1.25 ± 0.20
C2012X5R1C225M/1.25	X5R	16V	2,200,000	± 20%	1.25 ± 0.20
C2012X5R1C475K/1.25	X5R	16V	4,700,000	± 10%	1.25 ± 0.20
C2012X5R1C475M/1.25	X5R	16V	4,700,000	± 20%	1.25 ± 0.20
C2012X5R1C685K	X5R	16V	6,800,000	± 10%	1.25 ± 0.20
C2012X5R1C685M	X5R	16V	6,800,000	± 20%	1.25 ± 0.20
C2012X5R1C106K/0.85	X5R	16V	10,000,000	± 10%	0.85 ± 0.10
C2012X5R1C106M/0.85	X5R	16V	10,000,000	± 20%	0.85 ± 0.10
C2012X5R1C106K/1.25	X5R	16V	10,000,000	± 10%	1.25 ± 0.20
C2012X5R1C106M/1.25	X5R	16V	10,000,000	± 20%	1.25 ± 0.20
C2012X5R1C226K	X5R	16V	22,000,000	± 10%	1.25 ± 0.20
C2012X5R1C226M	X5R	16V	22,000,000	± 20%	1.25 ± 0.20
C2012X5R1A105K/0.85	X5R	10V	1,000,000	± 10%	0.85 ± 0.10
C2012X5R1A105M/0.85	X5R	10V	1,000,000	± 20%	0.85 ± 0.10



## Capacitance Range Table

# C2012 [EIA CC0805]

### Class 2 (Temperature Stable)

Temperature Characteristics: X5R (-55 to +85°C, ±15%)

TDK Part Number (Ordering Code)	Temperature Characteristics	Rated Voltage	Capacitance (pF)	Capacitance Tolerance	Thickness (mm)
C2012X5R1A105K/1.25	X5R	10V	1,000,000	± 10%	1.25 ± 0.20
C2012X5R1A105M/1.25	X5R	10V	1,000,000	± 20%	1.25 ± 0.20
C2012X5R1A225K/0.85	X5R	10V	2,200,000	± 10%	0.85 ± 0.10
C2012X5R1A225M/0.85	X5R	10V	2,200,000	± 20%	0.85 ± 0.10
C2012X5R1A225K/1.25	X5R	10V	2,200,000	± 10%	1.25 ± 0.20
C2012X5R1A225M/1.25	X5R	10V	2,200,000	± 20%	1.25 ± 0.20
C2012X5R1A335K	X5R	10V	3,300,000	± 10%	1.25 ± 0.20
C2012X5R1A335M	X5R	10V	3,300,000	± 20%	1.25 ± 0.20
C2012X5R1A475K/0.85	X5R	10V	4,700,000	± 10%	0.85 ± 0.10
C2012X5R1A475M/0.85	X5R	10V	4,700,000	± 20%	0.85 ± 0.10
C2012X5R1A475K/1.25	X5R	10V	4,700,000	± 10%	1.25 ± 0.20
C2012X5R1A475M/1.25	X5R	10V	4,700,000	± 20%	1.25 ± 0.20
C2012X5R1A106K/0.85	X5R	10V	10,000,000	± 10%	0.85 ± 0.10
C2012X5R1A106M/0.85	X5R	10V	10,000,000	± 20%	0.85 ± 0.10
C2012X5R1A106K/1.25	X5R	10V	10,000,000	± 10%	1.25 ± 0.20
C2012X5R1A106M/1.25	X5R	10V	10,000,000	± 20%	1.25 ± 0.20
C2012X5R1A156M	X5R	10V	15,000,000	± 20%	1.25 ± 0.20
C2012X5R1A226M/0.85	X5R	10V	22,000,000	± 20%	0.85 ± 0.10
C2012X5R1A226K/1.25	X5R	10V	22,000,000	± 10%	1.25 ± 0.20
C2012X5R1A226M/1.25	X5R	10V	22,000,000	± 20%	1.25 ± 0.20
C2012X5R0J225K/0.85	X5R	6.3V	2,200,000	± 10%	0.85 ± 0.10
C2012X5R0J225M/0.85	X5R	6.3V	2,200,000	± 20%	0.85 ± 0.10
C2012X5R0J225K/1.25	X5R	6.3V	2,200,000	± 10%	1.25 ± 0.20
C2012X5R0J225M/1.25	X5R	6.3V	2,200,000	± 20%	1.25 ± 0.20
C2012X5R0J335K/1.25	X5R	6.3V	3,300,000	± 10%	1.25 ± 0.20
C2012X5R0J335M/1.25	X5R	6.3V	3,300,000	± 20%	1.25 ± 0.20
C2012X5R0J475K/0.85	X5R	6.3V	4,700,000	± 10%	0.85 ± 0.10
C2012X5R0J475M/0.85	X5R	6.3V	4,700,000	± 20%	0.85 ± 0.10
C2012X5R0J475K/1.25	X5R	6.3V	4,700,000	± 10%	1.25 ± 0.20
C2012X5R0J475M/1.25	X5R	6.3V	4,700,000	± 20%	1.25 ± 0.20
C2012X5R0J685K/1.25	X5R	6.3V	6,800,000	± 10%	1.25 ± 0.20
C2012X5R0J685M/1.25	X5R	6.3V	6,800,000	± 20%	1.25 ± 0.20
C2012X5R0J106K/0.85	X5R	6.3V	10,000,000	± 10%	0.85 ± 0.10
C2012X5R0J106M/0.85	X5R	6.3V	10,000,000	± 20%	0.85 ± 0.10
C2012X5R0J106K/1.25	X5R	6.3V	10,000,000	± 10%	1.25 ± 0.20
C2012X5R0J106M/1.25	X5R	6.3V	10,000,000	± 20%	1.25 ± 0.20
C2012X5R0J156M/0.85	X5R	6.3V	15,000,000	± 20%	0.85 ± 0.10
C2012X5R0J156M/1.25	X5R	6.3V	15,000,000	± 20%	1.25 ± 0.20
C2012X5R0J226M/0.85	X5R	6.3V	22,000,000	± 20%	0.85 ± 0.10
C2012X5R0J226K/1.25	X5R	6.3V	22,000,000	± 10%	1.25 ± 0.20
C2012X5R0J226M/1.25	X5R	6.3V	22,000,000	± 20%	1.25 ± 0.20
C2012X5R0J336M	X5R	6.3V	33,000,000	± 20%	1.25 ± 0.20



## Capacitance Range Table

# C2012 [EIA CC0805]

### Class 2 (Temperature Stable)

Temperature Characteristics: X5R (-55 to +85°C, ±15%), Y5V(-30 to +85°C, +22/-82%)

TDK Part Number (Ordering Code)	Temperature Characteristics	Rated Voltage	Capacitance (pF)	Capacitance Tolerance	Thickness (mm)
C2012X5R0J476M	X5R	6.3V	47,000,000	± 20%	1.25 ± 0.20
C2012X5R0G476M	X5R	4V	47,000,000	± 20%	1.25 ± 0.20
C2012Y5V1H104Z/0.60	Y5V	50V	100,000	+80/-20%	0.60 ± 0.10
C2012Y5V1H104Z/0.85	Y5V	50V	100,000	+80/-20%	0.85 ± 0.10
C2012Y5V1H474Z/0.85	Y5V	50V	470,000	+80/-20%	0.85 ± 0.10
C2012Y5V1H105Z/0.85	Y5V	50V	1,000,000	+80/-20%	0.85 ± 0.10
C2012Y5V1H105Z/1.25	Y5V	50V	1,000,000	+80/-20%	1.25 ± 0.20
C2012Y5V1H225Z	Y5V	50V	2,200,000	+80/-20%	1.25 ± 0.20
C2012Y5V1E105Z/0.85	Y5V	25V	1,000,000	+80/-20%	0.85 ± 0.10
C2012Y5V1E105Z/1.25	Y5V	25V	1,000,000	+80/-20%	1.25 ± 0.20
C2012Y5V1E225Z	Y5V	25V	2,200,000	+80/-20%	1.25 ± 0.20
C2012Y5V1E475Z	Y5V	25V	4,700,000	+80/-20%	1.25 ± 0.20
C2012Y5V1C105Z/0.85	Y5V	16V	1,000,000	+80/-20%	0.85 ± 0.10
C2012Y5V1C105Z/1.25	Y5V	16V	1,000,000	+80/-20%	1.25 ± 0.20
C2012Y5V1C225Z/0.85	Y5V	16V	2,200,000	+80/-20%	0.85 ± 0.10
C2012Y5V1C225Z/1.25	Y5V	16V	2,200,000	+80/-20%	1.25 ± 0.20
C2012Y5V1C475Z/0.85	Y5V	16V	4,700,000	+80/-20%	0.85 ± 0.10
C2012Y5V1C475Z/1.25	Y5V	16V	4,700,000	+80/-20%	1.25 ± 0.20
C2012Y5V1C106Z	Y5V	16V	10,000,000	+80/-20%	1.25 ± 0.20
C2012Y5V1A475Z/0.85	Y5V	10V	4,700,000	+80/-20%	0.85 ± 0.10
C2012Y5V1A475Z/1.25	Y5V	10V	4,700,000	+80/-20%	1.25 ± 0.20
C2012Y5V1A106Z	Y5V	10V	10,000,000	+80/-20%	1.25 ± 0.20
C2012Y5V0J106Z	Y5V	6.3V	10,000,000	+80/-20%	1.25 ± 0.20
C2012Y5V0J226Z	Y5V	6.3V	22,000,000	+80/-20%	1.25 ± 0.20



## Capacitance Range Chart

# C3216 [EIA CC1206]

### Capacitance Range Chart

Temperature Characteristics: C0G ( $0 \pm 30\text{ppm}/^\circ\text{C}$ )  
 Rated Voltage: 50V (1H), 25V (1E), 10V (1A)

Capacitance (pF)	Cap Code	Tolerance	C0G		SL
			1H (50V)	1E (25V)	1A (10V)
3,900	392	J: $\pm 5\%$			
4,700	472				
5,600	562				
6,800	682				
8,200	822				
10,000	103				
15,000	153				
22,000	223				
33,000	333				
47,000	473				
68,000	683				
100,000	104				
220,000	224				

### Capacitance Range Chart

Temperature Characteristics: X7R ( $\pm 15\%$ ), X6S ( $\pm 22\%$ ), X5R ( $\pm 15\%$ ), Y5V ( $+22/-82$ )  
 Rated Voltage: 50V (1H), 35V (1V), 25V (1E), 16V (1C), 10V (1A), 6.3V (0J), 4V(0G)

Capacitance (pF)	Cap Code	Tolerance	X5R						X6S			
			1H (50V)	1E (25V)	1C (16V)	1A (10V)	0J (6.3V)	0G (4V)	1A (10V)	0J (6.3V)	0G (4V)	
1,000,000	105	K: $\pm 10\%$ M: $\pm 20\%$										
2,200,000	225											
3,300,000	335											
4,700,000	475											
6,800,000	685											
10,000,000	106											
15,000,000	156											
22,000,000	226											
33,000,000	336											
47,000,000	476											
100,000,000	107											

Capacitance (pF)	Cap Code	Tolerance	X7R					Y5V				
			1H (50V)	1V (35V)	1E (25V)	1C (16V)	1A (10V)	1H (50V)	1E (25V)	1C (16V)	1A (10V)	0J (6.3V)
100,000	104	K: $\pm 10\%$ M: $\pm 20\%$ Z: $+80/-20\%$										
220,000	224											
330,000	334											
470,000	474											
680,000	684											
1,000,000	105											
1,500,000	155											
2,200,000	225											
3,300,000	335											
4,700,000	475											
6,800,000	685											
10,000,000	106											
22,000,000	226											
47,000,000	476											

### Standard Thickness

0.60 mm 
 0.85 mm 
 1.15 mm 
 1.30 mm 
 1.60 mm

• Standard capacitance and thickness is shown. Please refer to Capacitance Range Table for additional capacitance values and thicknesses.



## Capacitance Range Table

# C3216 [EIA CC1206]

### Class 1 (Temperature Compensating)

Temperature Characteristics: COG (-55 to 125°C, 0±30 ppm/°C), SL (-25 to +85°C, +350/-1000 ppm/°C)

TDK Part Number (Ordering Code)	Temperature Characteristics	Rated Voltage	Capacitance (pF)	Capacitance Tolerance	Thickness (mm)
C3216C0G1H392J	COG	50V	3,900	± 5%	0.60 ± 0.10
C3216C0G1H472J/0.60	COG	50V	4,700	± 5%	0.60 ± 0.10
C3216C0G1H472J/0.85	COG	50V	4,700	± 5%	0.85 ± 0.10
C3216C0G1H562J/0.60	COG	50V	5,600	± 5%	0.60 ± 0.10
C3216C0G1H562J/0.85	COG	50V	5,600	± 5%	0.85 ± 0.10
C3216C0G1H682J/0.60	COG	50V	6,800	± 5%	0.60 ± 0.10
C3216C0G1H822J/0.60	COG	50V	8,200	± 5%	0.60 ± 0.10
C3216C0G1H822J/0.85	COG	50V	8,200	± 5%	0.85 ± 0.10
C3216C0G1H822J/1.15	COG	50V	8,200	± 5%	1.15 ± 0.10
C3216C0G1H103J/0.60	COG	50V	10,000	± 5%	0.60 ± 0.10
C3216C0G1H103J/1.15	COG	50V	10,000	± 5%	1.15 ± 0.10
C3216C0G1H153J/0.60	COG	50V	15,000	± 5%	0.60 ± 0.10
C3216C0G1H153J/1.15	COG	50V	15,000	± 5%	1.15 ± 0.10
C3216C0G1H223J/0.60	COG	50V	22,000	± 5%	0.60 ± 0.10
C3216C0G1H223J/1.15	COG	50V	22,000	± 5%	1.15 ± 0.10
C3216C0G1H333J/0.85	COG	50V	33,000	± 5%	0.85 ± 0.10
C3216C0G1H333J/1.60	COG	50V	33,000	± 5%	1.60 ± 0.30
C3216C0G1H473J	COG	50V	47,000	± 5%	1.15 ± 0.10
C3216C0G1H683J	COG	50V	68,000	± 5%	1.60 ± 0.30
C3216C0G1H104J	COG	50V	100,000	± 5%	1.60 ± 0.30
C3216C0G1E822J	COG	25V	8,200	± 5%	0.60 ± 0.20
C3216C0G1E103J	COG	25V	10,000	± 5%	0.60 ± 0.20
C3216C0G1E153J	COG	25V	15,000	± 5%	0.60 ± 0.20
C3216C0G1E223J	COG	25V	22,000	± 5%	0.60 ± 0.10
C3216C0G1E333J	COG	25V	33,000	± 5%	0.85 ± 0.10
C3216C0G1E473J	COG	25V	47,000	± 5%	1.15 ± 0.10
C3216C0G1E683J	COG	25V	68,000	± 5%	1.60 ± 0.30
C3216C0G1E104J	COG	25V	100,000	± 5%	1.60 ± 0.30
C3216SL1A224J	SL	10V	220,000	± 5%	1.60 ± 0.30

### Class 2 (Temperature Stable)

Temperature Characteristics: X7R (-55 to +125°C, ±15%)

TDK Part Number (Ordering Code)	Temperature Characteristics	Rated Voltage	Capacitance (pF)	Capacitance Tolerance	Thickness (mm)
C3216X7R1H104K	X7R	50V	100,000	± 10%	0.85 ± 0.10
C3216X7R1H104M	X7R	50V	100,000	± 20%	0.85 ± 0.10
C3216X7R1H224K	X7R	50V	220,000	± 10%	1.15 ± 0.10
C3216X7R1H224M	X7R	50V	220,000	± 20%	1.15 ± 0.10
C3216X7R1H334K	X7R	50V	330,000	± 10%	1.60 ± 0.30
C3216X7R1H334M	X7R	50V	330,000	± 20%	1.60 ± 0.30
C3216X7R1H474K	X7R	50V	470,000	± 10%	1.60 ± 0.30
C3216X7R1H474M	X7R	50V	470,000	± 20%	1.60 ± 0.30
C3216X7R1H684K	X7R	50V	680,000	± 10%	1.60 ± 0.30
C3216X7R1H684M	X7R	50V	680,000	± 20%	1.60 ± 0.30
C3216X7R1H105K	X7R	50V	1,000,000	± 10%	1.60 ± 0.30



## Capacitance Range Table

# C3216 [EIA CC1206]

### Class 2 (Temperature Stable)

Temperature Characteristics: X7R (-55 to +125°C, ±15%)

TDK Part Number (Ordering Code)	Temperature Characteristics	Rated Voltage	Capacitance (pF)	Capacitance Tolerance	Thickness (mm)
C3216X7R1H105M	X7R	50V	1,000,000	± 20%	1.60 ± 0.30
C3216X7R1H155K	X7R	50V	1,500,000	± 10%	1.60 ± 0.30
C3216X7R1H155M	X7R	50V	1,500,000	± 20%	1.60 ± 0.30
C3216X7R1H225K	X7R	50V	2,200,000	± 10%	1.60 ± 0.30
C3216X7R1H225M	X7R	50V	2,200,000	± 20%	1.60 ± 0.30
C3216X7R1H335K	X7R	50V	3,300,000	± 10%	1.60 ± 0.30
C3216X7R1H335M	X7R	50V	3,300,000	± 20%	1.60 ± 0.30
C3216X7R1V335K	X7R	35V	3,300,000	± 10%	1.60 ± 0.30
C3216X7R1V475K	X7R	35V	4,700,000	± 10%	1.60 ± 0.30
C3216X7R1E224K	X7R	25V	220,000	± 10%	1.15 ± 0.10
C3216X7R1E224M	X7R	25V	220,000	± 20%	1.15 ± 0.10
C3216X7R1E334K	X7R	25V	330,000	± 10%	1.15 ± 0.10
C3216X7R1E334M	X7R	25V	330,000	± 20%	1.15 ± 0.10
C3216X7R1E474K/0.85	X7R	25V	470,000	± 10%	0.85 ± 0.10
C3216X7R1E474M/0.85	X7R	25V	470,000	± 20%	0.85 ± 0.10
C3216X7R1E684K/0.85	X7R	25V	680,000	± 10%	0.85 ± 0.10
C3216X7R1E684M/0.85	X7R	25V	680,000	± 20%	0.85 ± 0.10
C3216X7R1E105K/0.85	X7R	25V	1,000,000	± 10%	0.85 ± 0.10
C3216X7R1E105M/0.85	X7R	25V	1,000,000	± 20%	0.85 ± 0.10
C3216X7R1E105K/1.60	X7R	25V	1,000,000	± 10%	1.60 ± 0.30
C3216X7R1E105M/1.60	X7R	25V	1,000,000	± 20%	1.60 ± 0.30
C3216X7R1E155K	X7R	25V	1,500,000	± 10%	1.60 ± 0.30
C3216X7R1E155M	X7R	25V	1,500,000	± 20%	1.60 ± 0.30
C3216X7R1E225K	X7R	25V	2,200,000	± 10%	1.60 ± 0.30
C3216X7R1E225M	X7R	25V	2,200,000	± 20%	1.60 ± 0.30
C3216X7R1E335K	X7R	25V	3,300,000	± 10%	1.60 ± 0.30
C3216X7R1E335M	X7R	25V	3,300,000	± 20%	1.60 ± 0.30
C3216X7R1E475K	X7R	25V	4,700,000	± 10%	1.60 ± 0.30
C3216X7R1E475M	X7R	25V	4,700,000	± 20%	1.60 ± 0.30
C3216X7R1E685K	X7R	25V	6,800,000	± 10%	1.60 ± 0.30
C3216X7R1E685M	X7R	25V	6,800,000	± 20%	1.60 ± 0.30
C3216X7R1E106K	X7R	25V	10,000,000	± 10%	1.60 ± 0.30
C3216X7R1E106M	X7R	25V	10,000,000	± 20%	1.60 ± 0.30
C3216X7R1C474K	X7R	16V	470,000	± 10%	1.15 ± 0.10
C3216X7R1C474M	X7R	16V	470,000	± 20%	1.15 ± 0.10
C3216X7R1C105K/0.85	X7R	16V	1,000,000	± 10%	0.85 ± 0.10
C3216X7R1C105M/0.85	X7R	16V	1,000,000	± 20%	0.85 ± 0.10
C3216X7R1C105K/1.15	X7R	16V	1,000,000	± 10%	1.15 ± 0.10
C3216X7R1C105K/1.30	X7R	16V	1,000,000	± 10%	1.30 ± 0.15
C3216X7R1C225K/1.60	X7R	16V	2,200,000	± 10%	1.60 ± 0.30
C3216X7R1C225M/1.60	X7R	16V	2,200,000	± 20%	1.60 ± 0.30
C3216X7R1C335K/1.60	X7R	16V	3,300,000	± 10%	1.60 ± 0.30
C3216X7R1C335M/1.60	X7R	16V	3,300,000	± 20%	1.60 ± 0.30
C3216X7R1C475K/1.60	X7R	16V	4,700,000	± 10%	1.60 ± 0.30



## Capacitance Range Table

# C3216 [EIA CC1206]

### Class 2 (Temperature Stable)

Temperature Characteristics: X7R (-55 to +125°C, ±15%), X6S(-55 to 105°C, ±22%), X5R (-55 to +85°C, ±15%)

TDK Part Number (Ordering Code)	Temperature Characteristics	Rated Voltage	Capacitance (pF)	Capacitance Tolerance	Thickness (mm)
C3216X7R1C475M/1.60	X7R	16V	4,700,000	± 20%	1.60 ± 0.30
C3216X7R1C685K	X7R	16V	6,800,000	± 10%	1.60 ± 0.30
C3216X7R1C685M	X7R	16V	6,800,000	± 20%	1.60 ± 0.30
C3216X7R1C106K	X7R	16V	10,000,000	± 10%	1.60 ± 0.30
C3216X7R1C106M	X7R	16V	10,000,000	± 20%	1.60 ± 0.30
C3216X7R1A106K	X7R	10V	10,000,000	± 10%	1.60 ± 0.30
C3216X7R1A106M	X7R	10V	10,000,000	± 20%	1.60 ± 0.30
C3216X6S1A476M	X6S	10V	47,000,000	± 20%	1.60 ± 0.30
C3216X6S0J476M	X6S	6.3V	47,000,000	± 20%	1.60 ± 0.30
C3216X6S0G107M	X6S	4V	100,000,000	± 20%	1.60 ± 0.30
C3216X5R1H105K	X5R	50V	1,000,000	± 10%	1.60 ± 0.30
C3216X5R1H105M	X5R	50V	1,000,000	± 20%	1.60 ± 0.30
C3216X5R1H335K	X5R	50V	3,300,000	± 10%	1.60 ± 0.30
C3216X5R1H335M	X5R	50V	3,300,000	± 20%	1.60 ± 0.30
C3216X5R1H475K	X5R	50V	4,700,000	± 10%	1.60 ± 0.30
C3216X5R1H475M	X5R	50V	4,700,000	± 20%	1.60 ± 0.30
C3216X5R1H685K	X5R	50V	6,800,000	± 10%	1.60 ± 0.30
C3216X5R1H685M	X5R	50V	6,800,000	± 20%	1.60 ± 0.30
C3216X5R1H106K	X5R	50V	10,000,000	± 10%	1.60 ± 0.30
C3216X5R1H106M	X5R	50V	10,000,000	± 20%	1.60 ± 0.30
C3216X5R1E225K	X5R	25V	2,200,000	± 10%	1.60 ± 0.30
C3216X5R1E225M	X5R	25V	2,200,000	± 20%	1.60 ± 0.30
C3216X5R1E335K/1.60	X5R	25V	3,300,000	± 10%	1.60 ± 0.30
C3216X5R1E335M/1.60	X5R	25V	3,300,000	± 20%	1.60 ± 0.30
C3216X5R1E475K	X5R	25V	4,700,000	± 10%	1.60 ± 0.30
C3216X5R1E475M	X5R	25V	4,700,000	± 20%	1.60 ± 0.30
C3216X5R1E106K	X5R	25V	10,000,000	± 10%	1.60 ± 0.30
C3216X5R1E106M	X5R	25V	10,000,000	± 20%	1.60 ± 0.30
C3216X5R1E226M	X5R	25V	22,000,000	± 20%	1.60 ± 0.30
C3216X5R1C225K/1.60	X5R	16V	2,200,000	± 10%	1.60 ± 0.30
C3216X5R1C225M/1.60	X5R	16V	2,200,000	± 20%	1.60 ± 0.30
C3216X5R1C335K/1.60	X5R	16V	3,300,000	± 10%	1.60 ± 0.30
C3216X5R1C335M/1.60	X5R	16V	3,300,000	± 20%	1.60 ± 0.30
C3216X5R1C475K/1.15	X5R	16V	4,700,000	± 10%	1.15 ± 0.10
C3216X5R1C475M/1.15	X5R	16V	4,700,000	± 20%	1.15 ± 0.10
C3216X5R1C475K/1.60	X5R	16V	4,700,000	± 10%	1.60 ± 0.30
C3216X5R1C475M/1.60	X5R	16V	4,700,000	± 20%	1.60 ± 0.30
C3216X5R1C685K	X5R	16V	6,800,000	± 10%	1.60 ± 0.30
C3216X5R1C685M	X5R	16V	6,800,000	± 20%	1.60 ± 0.30
C3216X5R1C106K	X5R	16V	10,000,000	± 10%	1.60 ± 0.30
C3216X5R1C106M	X5R	16V	10,000,000	± 20%	1.60 ± 0.30
C3216X5R1C226M	X5R	16V	22,000,000	± 20%	1.60 ± 0.30
C3216X5R1C336M	X5R	16V	33,000,000	± 20%	1.60 ± 0.30
C3216X5R1C476M	X5R	16V	47,000,000	± 20%	1.60 ± 0.30



## Capacitance Range Table

# C3216 [EIA CC1206]

### Class 2 (Temperature Stable)

Temperature Characteristics: X5R (-55 to +85°C, ±15%), Y5V(-30 to +85°C, +22/-82%)

TDK Part Number (Ordering Code)	Temperature Characteristics	Rated Voltage	Capacitance (pF)	Capacitance Tolerance	Thickness (mm)
C3216X5R1A225K/0.85	X5R	10V	2,200,000	± 10%	0.85 ± 0.10
C3216X5R1A225M/0.85	X5R	10V	2,200,000	± 20%	0.85 ± 0.10
C3216X5R1A335K/0.85	X5R	10V	3,300,000	± 10%	0.85 ± 0.10
C3216X5R1A335M/0.85	X5R	10V	3,300,000	± 20%	0.85 ± 0.10
C3216X5R1A335K/1.15	X5R	10V	3,300,000	± 10%	1.15 ± 0.10
C3216X5R1A335M/1.15	X5R	10V	3,300,000	± 20%	1.15 ± 0.10
C3216X5R1A475K	X5R	10V	4,700,000	± 10%	1.60 ± 0.30
C3216X5R1A475M	X5R	10V	4,700,000	± 20%	1.60 ± 0.30
C3216X5R1A106K	X5R	10V	10,000,000	± 10%	1.60 ± 0.30
C3216X5R1A106M	X5R	10V	10,000,000	± 20%	1.60 ± 0.30
C3216X5R1A226M	X5R	10V	22,000,000	± 20%	1.60 ± 0.30
C3216X5R1A336M	X5R	10V	33,000,000	± 20%	1.60 ± 0.30
C3216X5R1A476M	X5R	10V	47,000,000	± 20%	1.60 ± 0.30
C3216X5R1A107M	X5R	10V	100,000,000	± 20%	1.60 ± 0.30
C3216X5R0J106K/0.85	X5R	6.3V	10,000,000	± 10%	0.85 ± 0.10
C3216X5R0J106M/0.85	X5R	6.3V	10,000,000	± 20%	0.85 ± 0.10
C3216X5R0J106K/1.60	X5R	6.3V	10,000,000	± 10%	1.60 ± 0.30
C3216X5R0J106M/1.60	X5R	6.3V	10,000,000	± 20%	1.60 ± 0.30
C3216X5R0J156M	X5R	6.3V	15,000,000	± 20%	1.60 ± 0.30
C3216X5R0J226M/0.85	X5R	6.3V	22,000,000	± 20%	0.85 ± 0.10
C3216X5R0J226K/1.60	X5R	6.3V	22,000,000	± 10%	1.60 ± 0.30
C3216X5R0J226M/1.60	X5R	6.3V	22,000,000	± 20%	1.60 ± 0.30
C3216X5R0J336M	X5R	6.3V	33,000,000	± 20%	1.30 ± 0.15
C3216X5R0J476M	X5R	6.3V	47,000,000	± 20%	1.60 ± 0.30
C3216X5R0J107M	X5R	6.3V	100,000,000	± 20%	1.60 ± 0.30
C3216X5R0G107M	X5R	4V	100,000,000	± 20%	1.60 ± 0.30
C3216Y5V1H225Z/0.85	Y5V	50V	2,200,000	+80/-20%	0.85 ± 0.10
C3216Y5V1H225Z/1.15	Y5V	50V	2,200,000	+80/-20%	1.15 ± 0.10
C3216Y5V1H475Z	Y5V	50V	4,700,000	+80/-20%	1.60 ± 0.30
C3216Y5V1E475Z/0.85	Y5V	25V	4,700,000	+80/-20%	0.85 ± 0.10
C3216Y5V1E475Z/1.15	Y5V	25V	4,700,000	+80/-20%	1.15 ± 0.10
C3216Y5V1E106Z	Y5V	25V	10,000,000	+80/-20%	1.60 ± 0.30
C3216Y5V1C475Z/0.85	Y5V	16V	4,700,000	+80/-20%	0.85 ± 0.10
C3216Y5V1C475Z/1.15	Y5V	16V	4,700,000	+80/-20%	1.15 ± 0.10
C3216Y5V1C475Z/1.30	Y5V	16V	4,700,000	+80/-20%	1.30 ± 0.15
C3216Y5V1C106Z	Y5V	16V	10,000,000	+80/-20%	1.60 ± 0.30
C3216Y5V1C226Z	Y5V	16V	22,000,000	+80/-20%	1.60 ± 0.30
C3216Y5V1A106Z/0.85	Y5V	10V	10,000,000	+80/-20%	0.85 ± 0.10
C3216Y5V1A106Z/1.15	Y5V	10V	10,000,000	+80/-20%	1.15 ± 0.10
C3216Y5V1A226Z	Y5V	10V	22,000,000	+80/-20%	1.60 ± 0.30
C3216Y5V0J476Z	Y5V	6.3V	47,000,000	+80/-20%	1.60 ± 0.30



## Capacitance Range Chart

# C3225 [EIA CC1210]

### Capacitance Range Chart

Temperature Characteristics: C0G ( $0 \pm 30\text{ppm}/^\circ\text{C}$ )  
 Rated Voltage: 50V (1H)

Capacitance (pF)	Cap Code	Tolerance	C0G
			1H (50V)
22,000	223	J: $\pm 5\%$	
33,000	333		
47,000	473		
68,000	683		
100,000	104		

### Capacitance Range Chart

Temperature Characteristics: X7R ( $\pm 15\%$ ), X7S ( $\pm 22\%$ ), X5R ( $\pm 15\%$ ), X6S ( $\pm 22\%$ ), Y5V ( $+22/-82\%$ )  
 Rated Voltage: 50V (1H), 25V (1E), 16V (1C), 10V (1A), 6.3V (0J), 4V (0G)

Capacitance (pF)	Cap Code	Tolerance	X5R					X6S		
			1H (50V)	1E (25V)	1C (16V)	1A (10V)	0J (6.3V)	1H (50V)	0J (6.3V)	0G (4V)
4,700,000	475	K: $\pm 10\%$ M: $\pm 20\%$								
10,000,000	106									
15,000,000	156									
22,000,000	226									
33,000,000	336									
47,000,000	476									
68,000,000	686									
100,000,000	107									

Capacitance (pF)	Cap Code	Tolerance	X7R				X7S
			1H (50V)	1E (25V)	1C (16V)	1A (10V)	1H (50V)
470,000	474	K: $\pm 10\%$ M: $\pm 20\%$					
1,000,000	105						
1,500,000	155						
2,200,000	225						
3,300,000	335						
4,700,000	475						
6,800,000	685						
10,000,000	106						
15,000,000	156						
22,000,000	226						

Capacitance (pF)	Cap Code	Tolerance	Y5V				
			1H (50V)	1E (25V)	1C (16V)	1A (10V)	0J (6.3V)
4,700,000	475	Z: $+80/-20\%$					
10,000,000	106						
22,000,000	226						
47,000,000	476						
100,000,000	107						

### Standard Thickness

1.15 mm
 1.25 mm
 1.30 mm
 1.60 mm
 2.00 mm
 2.50 mm
 2.30 mm

• Standard capacitance and thickness is shown. Please refer to Capacitance Range Table for additional capacitance values and thicknesses.



## Capacitance Range Table

# C3225 [EIA CC1210]

### Class 1 (Temperature Compensating)

Temperature Characteristics: C0G (-55 to 125°C, 0±30 ppm/°C)

TDK Part Number (Ordering Code)	Temperature Characteristics	Rated Voltage	Capacitance (pF)	Capacitance Tolerance	Thickness (mm)
C3225C0G1H223J	C0G	50V	22,000	± 5%	1.30 ± 0.15
C3225C0G1H333J	C0G	50V	33,000	± 5%	1.60 ± 0.30
C3225C0G1H473J	C0G	50V	47,000	± 5%	2.00 ± 0.20
C3225C0G1H683J	C0G	50V	68,000	± 5%	2.00 ± 0.20
C3225C0G1H104J	C0G	50V	100,000	± 5%	2.50 ± 0.30

### Class 2 (Temperature Stable)

Temperature Characteristics: X7R (-55 to +125°C, ±15%), X7S (-55 to +125°C, ±22%), X6S (-55 to +105°C, ±22%)

TDK Part Number (Ordering Code)	Temperature Characteristics	Rated Voltage	Capacitance (pF)	Capacitance Tolerance	Thickness (mm)
C3225X7R1H474K/1.30	X7R	50V	470,000	± 10%	1.30 ± 0.15
C3225X7R1H474M/1.30	X7R	50V	470,000	± 20%	1.30 ± 0.15
C3225X7R1H105K/1.60	X7R	50V	1,000,000	± 10%	1.60 ± 0.30
C3225X7R1H105M/1.60	X7R	50V	1,000,000	± 20%	1.60 ± 0.30
C3225X7R1H105K/2.00	X7R	50V	1,000,000	± 10%	2.00 ± 0.20
C3225X7R1H105M/2.00	X7R	50V	1,000,000	± 20%	2.00 ± 0.20
C3225X7R1H155K	X7R	50V	1,500,000	± 10%	2.00 ± 0.20
C3225X7R1H155M	X7R	50V	1,500,000	± 20%	2.00 ± 0.20
C3225X7R1H225K/2.00	X7R	50V	2,200,000	± 10%	2.00 ± 0.20
C3225X7R1H225M/2.00	X7R	50V	2,200,000	± 20%	2.00 ± 0.20
C3225X7R1H225K/2.50	X7R	50V	2,200,000	± 10%	2.50 ± 0.30
C3225X7R1H225M/2.50	X7R	50V	2,200,000	± 20%	2.50 ± 0.30
C3225X7R1H335K	X7R	50V	3,300,000	± 10%	2.50 ± 0.30
C3225X7R1H335M	X7R	50V	3,300,000	± 20%	2.50 ± 0.30
C3225X7R1H475K	X7R	50V	4,700,000	± 10%	2.50 ± 0.30
C3225X7R1H475M	X7R	50V	4,700,000	± 20%	2.50 ± 0.30
C3225X6S1H475K	X6S	50V	4,700,000	± 10%	2.50 ± 0.30
C3225X6S1H475M	X6S	50V	4,700,000	± 20%	2.50 ± 0.30
C3225X7S1H685K	X7S	50V	6,800,000	± 10%	2.50 ± 0.30
C3225X7S1H685M	X7S	50V	6,800,000	± 20%	2.50 ± 0.30
C3225X7S1H106K	X7S	50V	10,000,000	± 10%	2.50 ± 0.30
C3225X7S1H106M	X7S	50V	10,000,000	± 20%	2.50 ± 0.30
C3225X7R1E225K/1.60	X7R	25V	2,200,000	± 10%	1.60 ± 0.30
C3225X7R1E225M/1.60	X7R	25V	2,200,000	± 20%	1.60 ± 0.30
C3225X7R1E335K	X7R	25V	3,300,000	± 10%	1.60 ± 0.30
C3225X7R1E335M	X7R	25V	3,300,000	± 20%	1.60 ± 0.30
C3225X7R1E475K	X7R	25V	4,700,000	± 10%	2.00 ± 0.20
C3225X7R1E475M	X7R	25V	4,700,000	± 20%	2.00 ± 0.20
C3225X7R1E685K/2.50	X7R	25V	6,800,000	± 10%	2.50 ± 0.30
C3225X7R1E685M/2.50	X7R	25V	6,800,000	± 20%	2.50 ± 0.30
C3225X7R1E106K	X7R	25V	10,000,000	± 10%	2.50 ± 0.30
C3225X7R1E106M	X7R	25V	10,000,000	± 20%	2.50 ± 0.30
C3225X7R1C106K	X7R	16V	10,000,000	± 10%	2.00 ± 0.20
C3225X7R1C106M	X7R	16V	10,000,000	± 20%	2.00 ± 0.20
C3225X7R1C156M	X7R	16V	15,000,000	± 20%	2.50 ± 0.30



## Capacitance Range Table

# C3225 [EIA CC1210]

### Class 2 (Temperature Stable)

Temperature Characteristics: X7R (-55 to +125°C, ±15%), X6S (-55 to +105°C, ±22%), X5R (-55 to +85°C, ±15%), Y5V(-30 to +85°C, +22/-82%)

TDK Part Number (Ordering Code)	Temperature Characteristics	Rated Voltage	Capacitance (pF)	Capacitance Tolerance	Thickness (mm)
C3225X7R1C226K	X7R	16V	22,000,000	± 10%	2.50 ± 0.30
C3225X7R1C226M	X7R	16V	22,000,000	± 20%	2.50 ± 0.30
C3225X7R1A226K/2.30	X7R	10V	22,000,000	± 10%	2.30 ± 0.20
C3225X7R1A226M/2.30	X7R	10V	22,000,000	± 20%	2.30 ± 0.20
C3225X5R1H475K	X5R	50V	4,700,000	± 10%	2.50 ± 0.30
C3225X5R1H475M	X5R	50V	4,700,000	± 20%	2.50 ± 0.30
C3225X5R1E106K	X5R	25V	10,000,000	± 10%	2.50 ± 0.30
C3225X5R1E106M	X5R	25V	10,000,000	± 20%	2.50 ± 0.30
C3225X5R1C106K	X5R	16V	10,000,000	± 10%	2.00 ± 0.20
C3225X5R1C106M	X5R	16V	10,000,000	± 20%	2.00 ± 0.20
C3225X5R1C156M	X5R	16V	15,000,000	± 20%	2.50 ± 0.30
C3225X5R1C226K	X5R	16V	22,000,000	± 10%	2.50 ± 0.30
C3225X5R1C226M	X5R	16V	22,000,000	± 20%	2.50 ± 0.30
C3225X5R1A106K	X5R	10V	10,000,000	± 10%	2.00 ± 0.20
C3225X5R1A106M	X5R	10V	10,000,000	± 20%	2.00 ± 0.20
C3225X5R1A156M/2.30	X5R	10V	15,000,000	± 20%	2.30 ± 0.20
C3225X5R1A226M	X5R	10V	22,000,000	± 20%	2.30 ± 0.20
C3225X5R1A336M	X5R	10V	33,000,000	± 20%	2.00 ± 0.20
C3225X5R1A476M	X5R	10V	47,000,000	± 20%	2.50 ± 0.30
C3225X5R0J226M/1.60	X5R	6.3V	22,000,000	± 20%	1.60 ± 0.30
C3225X5R0J226K/2.00	X5R	6.3V	22,000,000	± 10%	2.00 ± 0.20
C3225X5R0J226M/2.00	X5R	6.3V	22,000,000	± 20%	2.00 ± 0.20
C3225X5R0J226K/2.50	X5R	6.3V	22,000,000	± 10%	2.50 ± 0.30
C3225X5R0J226M/2.50	X5R	6.3V	22,000,000	± 20%	2.50 ± 0.30
C3225X5R0J336M/2.00	X5R	6.3V	33,000,000	± 20%	2.00 ± 0.20
C3225X5R0J336M/2.50	X5R	6.3V	33,000,000	± 20%	2.50 ± 0.30
C3225X5R0J476M	X5R	6.3V	47,000,000	± 20%	2.50 ± 0.30
C3225X5R0J686M	X5R	6.3V	68,000,000	± 20%	2.00 ± 0.20
C3225X5R0J107M	X5R	6.3V	100,000,000	± 20%	2.50 ± 0.30
C3225X6S0J476M	X6S	6.3V	47,000,000	± 20%	2.50 ± 0.30
C3225X6S0J107M	X6S	6.3V	100,000,000	± 20%	2.50 ± 0.30
C3225X6S0G107M	X6S	4V	100,000,000	± 20%	2.50 ± 0.30
C3225Y5V1H475Z/1.15	Y5V	50V	4,700,000	+80/-20%	1.15 ± 0.10
C3225Y5V1H475Z/1.60	Y5V	50V	4,700,000	+80/-20%	1.60 ± 0.30
C3225Y5V1H106Z	Y5V	50V	10,000,000	+80/-20%	1.60 ± 0.30
C3225Y5V1E106Z/1.30	Y5V	25V	10,000,000	+80/-20%	1.30 ± 0.15
C3225Y5V1E106Z/1.60	Y5V	25V	10,000,000	+80/-20%	1.60 ± 0.30
C3225Y5V1E226Z	Y5V	25V	22,000,000	+80/-20%	2.00 ± 0.20
C3225Y5V1C106Z/1.15	Y5V	16V	10,000,000	+80/-20%	1.15 ± 0.10
C3225Y5V1C106Z/1.60	Y5V	16V	10,000,000	+80/-20%	1.60 ± 0.30
C3225Y5V1C226Z/1.30	Y5V	16V	22,000,000	+80/-20%	1.30 ± 0.15
C3225Y5V1C226Z/2.00	Y5V	16V	22,000,000	+80/-20%	2.00 ± 0.20
C3225Y5V1C476Z	Y5V	16V	47,000,000	+80/-20%	2.30 ± 0.20
C3225Y5V1A226Z/1.15	Y5V	10V	22,000,000	+80/-20%	1.15 ± 0.10



Capacitance Range Table

C3225 [EIA CC1210]

**Class 2 (Temperature Stable)**

Temperature Characteristics: Y5V(-30 to +85°C, +22/-82%)

TDK Part Number (Ordering Code)	Temperature Characteristics	Rated Voltage	Capacitance (pF)	Capacitance Tolerance	Thickness (mm)
C3225Y5V1A476Z	Y5V	10V	47,000,000	+80/-20%	2.00 ± 0.20
C3225Y5V0J107Z	Y5V	6.3V	100,000,000	+80/-20%	2.50 ± 0.30



## Capacitance Range Chart

# C4532 [EIA CC1812]

### Capacitance Range Chart

Temperature Characteristics: C0G ( $0 \pm 30\text{ppm}/^\circ\text{C}$ )  
 Rated Voltage: 50V (1H)

Capacitance (pF)	Cap Code	Tolerance	C0G
			1H (50V)
47,000	473	J: $\pm 5\%$	
68,000	683		
100,000	104		
150,000	154		
220,000	224		

### Capacitance Range Chart

Temperature Characteristics: X7R ( $\pm 15\%$ ), X5R ( $\pm 15\%$ ), Y5V ( $+22/-82\%$ )  
 Rated Voltage: 50V (1H), 25V (1E), 16V (1C), 10V (1A), 6.3V (0J)

Capacitance (pF)	Cap Code	Tolerance	X7R			X5R			
			1H (50V)	1E (25V)	1C (16V)	1E (25V)	1C (16V)	1A (10V)	0J (6.3V)
1,000,000	105	K: $\pm 10\%$ M: $\pm 20\%$							
1,500,000	155								
2,200,000	225								
3,300,000	335								
4,700,000	475								
6,800,000	685								
10,000,000	106								
15,000,000	156								
22,000,000	226								
33,000,000	336								
47,000,000	476								
68,000,000	686								
100,000,000	107								

Capacitance (pF)	Cap Code	Tolerance	Y5V			
			1H (50V)	1E (25V)	1C (16V)	1A (10V)
10,000,000	106	Z: $+80/-20\%$				
22,000,000	226					
47,000,000	476					
100,000,000	107					

### Standard Thickness

1.60 mm
 2.00 mm
 2.30 mm
 2.50 mm
 2.80 mm
 3.20 mm

• Standard capacitance and thickness is shown. Please refer to Capacitance Range Table for additional capacitance values and thicknesses.



## Capacitance Range Table

# C4532 [EIA CC1812]

### Class 1 (Temperature Compensating)

Temperature Characteristics: C0G (-55 to 125°C, 0±30 ppm/°C)

TDK Part Number (Ordering Code)	Temperature Characteristics	Rated Voltage	Capacitance (pF)	Capacitance Tolerance	Thickness (mm)
C4532C0G1H473J	C0G	50V	47,000	± 5%	1.60 ± 0.30
C4532C0G1H683J	C0G	50V	68,000	± 5%	1.60 ± 0.30
C4532C0G1H104J	C0G	50V	100,000	± 5%	2.00 ± 0.20
C4532C0G1H154J	C0G	50V	150,000	± 5%	2.50 ± 0.30
C4532C0G1H224J	C0G	50V	220,000	± 5%	3.20 ± 0.30

### Class 2 (Temperature Stable)

Temperature Characteristics: X7R (-55 to +125°C, ±15%), X5R (-55 to +85°C, ±15%)

TDK Part Number (Ordering Code)	Temperature Characteristics	Rated Voltage	Capacitance (pF)	Capacitance Tolerance	Thickness (mm)
C4532X7R1H105K	X7R	50V	1,000,000	± 10%	1.60 ± 0.30
C4532X7R1H105M	X7R	50V	1,000,000	± 20%	1.60 ± 0.30
C4532X7R1H155K/1.60	X7R	50V	1,500,000	± 10%	1.60 ± 0.30
C4532X7R1H155M/1.60	X7R	50V	1,500,000	± 20%	1.60 ± 0.30
C4532X7R1H225K	X7R	50V	2,200,000	± 10%	1.60 ± 0.30
C4532X7R1H225M	X7R	50V	2,200,000	± 20%	1.60 ± 0.30
C4532X7R1H335K	X7R	50V	3,300,000	± 10%	2.00 ± 0.20
C4532X7R1H335M	X7R	50V	3,300,000	± 20%	2.00 ± 0.20
C4532X7R1H475K/2.00	X7R	50V	4,700,000	± 10%	2.00 ± 0.20
C4532X7R1H475M/2.00	X7R	50V	4,700,000	± 20%	2.00 ± 0.20
C4532X7R1H685K	X7R	50V	6,800,000	± 10%	2.50 ± 0.30
C4532X7R1H685M	X7R	50V	6,800,000	± 20%	2.50 ± 0.30
C4532X7R1E475M/2.00	X7R	25V	4,700,000	± 20%	2.00 ± 0.20
C4532X7R1E106K	X7R	25V	10,000,000	± 10%	2.50 ± 0.30
C4532X7R1E106M	X7R	25V	10,000,000	± 20%	2.50 ± 0.30
C4532X7R1E156M/2.80	X7R	25V	15,000,000	± 20%	2.80 ± 0.30
C4532X7R1E226M	X7R	25V	22,000,000	± 20%	2.50 ± 0.30
C4532X7R1C106K	X7R	16V	10,000,000	± 10%	2.30 ± 0.20
C4532X7R1C106M	X7R	16V	10,000,000	± 20%	2.30 ± 0.20
C4532X7R1C226M/2.00	X7R	16V	22,000,000	± 20%	2.00 ± 0.20
C4532X7R1C226M/2.30	X7R	16V	22,000,000	± 20%	2.30 ± 0.20
C4532X7R1C336M	X7R	16V	33,000,000	± 20%	2.50 ± 0.30
C4532X5R1E106K	X5R	25V	10,000,000	± 10%	2.50 ± 0.30
C4532X5R1E106M	X5R	25V	10,000,000	± 20%	2.50 ± 0.30
C4532X5R1E156M/2.80	X5R	25V	15,000,000	± 20%	2.80 ± 0.30
C4532X5R1E226M	X5R	25V	22,000,000	± 20%	2.50 ± 0.30
C4532X5R1C226M/2.00	X5R	16V	22,000,000	± 20%	2.00 ± 0.20
C4532X5R1C226M/2.30	X5R	16V	22,000,000	± 20%	2.30 ± 0.20
C4532X5R1C336M	X5R	16V	33,000,000	± 20%	2.50 ± 0.30
C4532X5R1A226M	X5R	10V	22,000,000	± 20%	2.30 ± 0.20
C4532X5R1A336M	X5R	10V	33,000,000	± 20%	2.30 ± 0.20
C4532X5R1A476M	X5R	10V	47,000,000	± 20%	2.80 ± 0.30
C4532X5R1A107M	X5R	10V	100,000,000	± 20%	2.80 ± 0.30
C4532X5R0J476M	X5R	6.3V	47,000,000	± 20%	2.50 ± 0.30
C4532X5R0J686M	X5R	6.3V	68,000,000	± 20%	2.80 ± 0.30



## Capacitance Range Table

# C4532 [EIA CC1812]

### Class 2 (Temperature Stable)

Temperature Characteristics: X5R (-55 to +85°C, ±15%), Y5V(-30 to +85°C, +22/-82%)

TDK Part Number (Ordering Code)	Temperature Characteristics	Rated Voltage	Capacitance (pF)	Capacitance Tolerance	Thickness (mm)
C4532X5R0J107M	X5R	6.3V	100,000,000	± 20%	2.80 ± 0.30
C4532Y5V1H106Z	Y5V	50V	10,000,000	+80/-20%	2.00 ± 0.20
C4532Y5V1E226Z	Y5V	25V	22,000,000	+80/-20%	2.00 ± 0.20
C4532Y5V1C476Z	Y5V	16V	47,000,000	+80/-20%	2.50 ± 0.30
C4532Y5V1A107Z	Y5V	10V	100,000,000	+80/-20%	2.50 ± 0.30



## Capacitance Range Chart

# C5750 [EIA CC2220]

### Capacitance Range Chart

Temperature Characteristics: X7R ( $\pm 15\%$ ), X5R ( $\pm 15\%$ ), Y5V (+22/-82%)  
 Rated Voltage: 50V (1H), 25V (1E), 16V (1C), 10V (1A), 6.3V (0J)

Capacitance (pF)	Cap Code	Tolerance	X7R			X5R				
			1H (50V)	1E (25V)	1C (16V)	1H (50V)	1E (25V)	1C (16V)	1A (10V)	0J (6.3V)
4,700,000	475	K: $\pm 10\%$ M: $\pm 20\%$								
6,800,000	685									
10,000,000	106									
15,000,000	156									
22,000,000	226									
33,000,000	336									
47,000,000	476									
68,000,000	686									
100,000,000	107									

Capacitance (pF)	Cap Code	Tolerance	Y5V			
			1H (50V)	1E (25V)	1C (16V)	1A (10V)
10,000,000	106	Z: +80/-20%				
22,000,000	226					
47,000,000	476					
100,000,000	107					

### Standard Thickness

2.00 mm  
 2.30 mm  
 2.50 mm  
 2.80 mm



## Capacitance Range Table

# C5750 [EIA CC2220]

### Class 2 (Temperature Stable)

Temperature Characteristics: X7R (-55 to +125°C, ±15%), X5R (-55 to +85°C, ±15%), Y5V (-30 to +85°C, +22/-82%)

TDK Part Number (Ordering Code)	Temperature Characteristics	Rated Voltage	Capacitance (pF)	Capacitance Tolerance	Thickness (mm)
C5750X7R1H475K/2.00	X7R	50V	4,700,000	± 10%	2.00 ± 0.20
C5750X7R1H475M/2.00	X7R	50V	4,700,000	± 20%	2.00 ± 0.20
C5750X7R1H475M/2.80	X7R	50V	4,700,000	± 20%	2.80 ± 0.20
C5750X7R1H685K	X7R	50V	6,800,000	± 10%	2.50 ± 0.30
C5750X7R1H685M	X7R	50V	6,800,000	± 20%	2.50 ± 0.30
C5750X7R1H106K	X7R	50V	10,000,000	± 10%	2.30 ± 0.20
C5750X7R1H106M	X7R	50V	10,000,000	± 20%	2.30 ± 0.20
C5750X7R1E106M	X7R	25V	10,000,000	± 20%	2.00 ± 0.20
C5750X7R1E156M	X7R	25V	15,000,000	± 20%	2.30 ± 0.20
C5750X7R1E226M	X7R	25V	22,000,000	± 20%	2.50 ± 0.30
C5750X7R1C226M	X7R	16V	22,000,000	± 20%	2.80 ± 0.20
C5750X7R1C476M	X7R	16V	47,000,000	± 20%	2.30 ± 0.20
C5750X5R1H106K	X5R	50V	10,000,000	± 10%	2.30 ± 0.20
C5750X5R1H106M	X5R	50V	10,000,000	± 20%	2.30 ± 0.20
C5750X5R1E226M	X5R	25V	22,000,000	± 20%	2.30 ± 0.20
C5750X5R1C336M	X5R	16V	33,000,000	± 20%	2.00 ± 0.20
C5750X5R1C476M	X5R	16V	47,000,000	± 20%	2.30 ± 0.20
C5750X5R1A686M	X5R	10V	68,000,000	± 20%	2.30 ± 0.20
C5750X5R1A107M	X5R	10V	100,000,000	± 20%	2.80 ± 0.20
C5750X5R0J107M	X5R	6.3V	100,000,000	± 20%	2.80 ± 0.20
C5750Y5V1H226Z	Y5V	50V	22,000,000	+80/-20%	2.00 ± 0.20
C5750Y5V1E476Z	Y5V	25V	47,000,000	+80/-20%	2.00 ± 0.20
C5750Y5V1C107Z	Y5V	16V	100,000,000	+80/-20%	2.50 ± 0.30
C5750Y5V1A107Z	Y5V	10V	100,000,000	+80/-20%	2.50 ± 0.30



## General Specifications

## C Series – General Application

No.	Item	Performance	Test or Inspection Method																					
1	<b>External Appearance</b>	No defects which may affect performance.	Inspect with magnifying glass (3×), in case of C0603 type, with magnifying glass (10×).																					
2	<b>Insulation Resistance</b>	10,000MΩ or 500MΩ•μF min. (As for the capacitors of rated voltage 16, 10 and 6.3V DC, 10,000 MΩ or 100MΩ•μF min.,) whichever smaller.	Apply rated voltage for 60s. As for the rated voltage 630V DC, apply 500V DC.																					
3	<b>Voltage Proof</b>	Withstand test voltage without insulation breakdown or other damage.	<table border="1"> <thead> <tr> <th>Class</th> <th>Apply voltage</th> </tr> </thead> <tbody> <tr> <td>Class 1</td> <td>3 × rated voltage</td> </tr> <tr> <td>Class 2</td> <td>2.5 × rated voltage</td> </tr> </tbody> </table> <p>Above DC voltage shall be applied for 1 to 5s. Charge / discharge current shall not exceed 50mA.</p>	Class	Apply voltage	Class 1	3 × rated voltage	Class 2	2.5 × rated voltage															
Class	Apply voltage																							
Class 1	3 × rated voltage																							
Class 2	2.5 × rated voltage																							
4	<b>Capacitance</b>	Within the specified tolerance.	<table border="1"> <thead> <tr> <th>Class</th> <th>Rated Capacitance</th> <th>Measuring Frequency</th> <th>Measuring voltage</th> </tr> </thead> <tbody> <tr> <td rowspan="2">Class 1</td> <td>C ≤ 1000pF</td> <td>1MHz±10%</td> <td rowspan="2">0.5 - 5 V<sub>rms</sub></td> </tr> <tr> <td>C &gt; 1000pF</td> <td>1kHz ± 10%</td> </tr> <tr> <td rowspan="2">Class 2</td> <td>C ≤ 10uF</td> <td>1kHz±10%</td> <td>0.5±0.2V<sub>rms</sub></td> </tr> <tr> <td>C &gt; 10uF</td> <td>120Hz ± 20%</td> <td>1.0±0.2V<sub>rms</sub> 0.5 ± 0.2 V<sub>rms</sub></td> </tr> </tbody> </table>	Class	Rated Capacitance	Measuring Frequency	Measuring voltage	Class 1	C ≤ 1000pF	1MHz±10%	0.5 - 5 V <sub>rms</sub>	C > 1000pF	1kHz ± 10%	Class 2	C ≤ 10uF	1kHz±10%	0.5±0.2V <sub>rms</sub>	C > 10uF	120Hz ± 20%	1.0±0.2V <sub>rms</sub> 0.5 ± 0.2 V <sub>rms</sub>				
Class	Rated Capacitance	Measuring Frequency	Measuring voltage																					
Class 1	C ≤ 1000pF	1MHz±10%	0.5 - 5 V <sub>rms</sub>																					
	C > 1000pF	1kHz ± 10%																						
Class 2	C ≤ 10uF	1kHz±10%	0.5±0.2V <sub>rms</sub>																					
	C > 10uF	120Hz ± 20%	1.0±0.2V <sub>rms</sub> 0.5 ± 0.2 V <sub>rms</sub>																					
5	<b>Q (Class 1)</b>	<table border="1"> <thead> <tr> <th>Rated Capacitance</th> <th>Q</th> </tr> </thead> <tbody> <tr> <td>30pF and over</td> <td>1,000 min.</td> </tr> <tr> <td>Under 30pF</td> <td>400+20×C min.</td> </tr> </tbody> </table> <p>C : Rated capacitance (pF)</p>	Rated Capacitance	Q	30pF and over	1,000 min.	Under 30pF	400+20×C min.	See No.4 in this table for measuring condition.															
Rated Capacitance	Q																							
30pF and over	1,000 min.																							
Under 30pF	400+20×C min.																							
6	<b>Dissipation Factor (Class 2)</b>	<table border="1"> <thead> <tr> <th>T.C.</th> <th>Rated Voltage</th> <th>D.F.</th> </tr> </thead> <tbody> <tr> <td rowspan="5">X5R X7R</td> <td rowspan="5">-</td> <td>0.03 max.</td> </tr> <tr> <td>0.05 max.</td> </tr> <tr> <td>0.75 max.</td> </tr> <tr> <td>0.1 max.</td> </tr> <tr> <td>0.125 max.</td> </tr> <tr> <td rowspan="5">Y5V</td> <td>50VDC</td> <td>0.05 max.</td> </tr> <tr> <td>25VDC</td> <td>0.075 max.</td> </tr> <tr> <td>16VDC</td> <td>0.10 max.</td> </tr> <tr> <td>10VDC</td> <td>0.125 max.</td> </tr> <tr> <td>6.3VDC</td> <td>0.20 max.</td> </tr> </tbody> </table>	T.C.	Rated Voltage	D.F.	X5R X7R	-	0.03 max.	0.05 max.	0.75 max.	0.1 max.	0.125 max.	Y5V	50VDC	0.05 max.	25VDC	0.075 max.	16VDC	0.10 max.	10VDC	0.125 max.	6.3VDC	0.20 max.	See No.4 in this table for measuring condition.
T.C.	Rated Voltage	D.F.																						
X5R X7R	-	0.03 max.																						
		0.05 max.																						
		0.75 max.																						
		0.1 max.																						
		0.125 max.																						
Y5V	50VDC	0.05 max.																						
	25VDC	0.075 max.																						
	16VDC	0.10 max.																						
	10VDC	0.125 max.																						
	6.3VDC	0.20 max.																						

**General Specifications**

# C Series – General Application

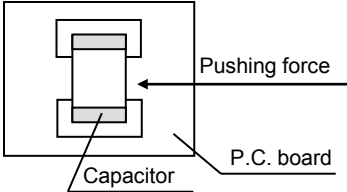
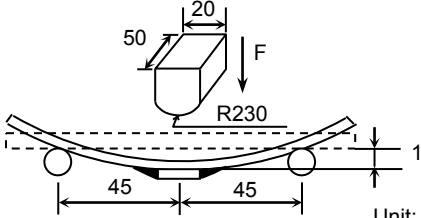
No.	Item	Performance	Test or Inspection Method																								
7	<b>Temperature Characteristics of Capacitance (Class 1)</b>	<table border="1"> <thead> <tr> <th>T.C.</th> <th>Temperature Coefficient</th> </tr> </thead> <tbody> <tr> <td>COG</td> <td><math>0 \pm 30</math> (ppm/°C)</td> </tr> </tbody> </table> <p>Capacitance drift Within <math>\pm 0.2\%</math> or <math>\pm 0.05\text{pF}</math>, whichever larger.</p>	T.C.	Temperature Coefficient	COG	$0 \pm 30$ (ppm/°C)	<p>Temperature coefficient shall be calculated based on values at 25°C and 85°C temperature.</p> <p>Measuring temperature below 20°C shall be -10°C and -25°C.</p>																				
T.C.	Temperature Coefficient																										
COG	$0 \pm 30$ (ppm/°C)																										
8	<b>Temperature Characteristics of Capacitance (Class 2)</b>	<p>Capacitance Change (%)</p> <table border="1"> <thead> <tr> <th colspan="2">No Voltage Applied</th> </tr> </thead> <tbody> <tr> <td>X5R:</td> <td><math>\pm 15\%</math></td> </tr> <tr> <td>X7R:</td> <td><math>\pm 15\%</math></td> </tr> <tr> <td>X6S:</td> <td><math>\pm 22\%</math></td> </tr> <tr> <td>X7S:</td> <td><math>\pm 22\%</math></td> </tr> <tr> <td>X7T:</td> <td>+22/-33%</td> </tr> <tr> <td>Y5V:</td> <td>+ 22/-82%</td> </tr> </tbody> </table>	No Voltage Applied		X5R:	$\pm 15\%$	X7R:	$\pm 15\%$	X6S:	$\pm 22\%$	X7S:	$\pm 22\%$	X7T:	+22/-33%	Y5V:	+ 22/-82%	<p>Capacitance shall be measured by the steps shown in the following table after thermal equilibrium is obtained for each step.</p> <p><math>\Delta C</math> be calculated ref. STEP 3 reading</p> <table border="1"> <thead> <tr> <th>Step</th> <th>Temperature (°C)</th> </tr> </thead> <tbody> <tr> <td>1</td> <td>Reference temp. <math>\pm 2</math></td> </tr> <tr> <td>2</td> <td>Min. operating temp. <math>\pm 2</math></td> </tr> <tr> <td>3</td> <td>Reference temp. <math>\pm 2</math></td> </tr> <tr> <td>4</td> <td>Max. operating temp. <math>\pm 2</math></td> </tr> </tbody> </table> <p>Measuring voltage: 0.1, 0.2, 0.5, 1.0V<sub>rms</sub>.</p>	Step	Temperature (°C)	1	Reference temp. $\pm 2$	2	Min. operating temp. $\pm 2$	3	Reference temp. $\pm 2$	4	Max. operating temp. $\pm 2$
No Voltage Applied																											
X5R:	$\pm 15\%$																										
X7R:	$\pm 15\%$																										
X6S:	$\pm 22\%$																										
X7S:	$\pm 22\%$																										
X7T:	+22/-33%																										
Y5V:	+ 22/-82%																										
Step	Temperature (°C)																										
1	Reference temp. $\pm 2$																										
2	Min. operating temp. $\pm 2$																										
3	Reference temp. $\pm 2$																										
4	Max. operating temp. $\pm 2$																										
9	<b>Robustness of Terminations</b>	No sign of termination coming off, breakage of ceramic, or other abnormal signs.	<p>Reflow solder the capacitor on P.C. board (shown in Appendix 1a or Appendix 1b) and apply a pushing force of 2N (C0603, C1005) or 5N (C1608, C2012, C3216, C3225, C4532, C5750) for <math>10 \pm 1\text{s}</math>.</p> 																								
10	<b>Bending</b>	No mechanical damage.	<p>Reflow solder the capacitor on P.C. board (shown in Appendix 2a or Appendix 2b) and bend it for 1mm.</p>  <p style="text-align: right;">Unit: mm</p>																								



## General Specifications

# C Series – General Application

No.	Item	Performance	Test or Inspection Method													
11	<b>Solderability</b>	<p>New solder to cover over 75% of termination.</p> <p>25% may have pinholes or rough spots but not concentrated in one spot.</p> <p>Ceramic surface of A sections shall not be exposed due to melting or shifting of termination material.</p>	<p>Completely soak both terminations in solder at <math>235 \pm 5^\circ\text{C}</math> for <math>2 \pm 0.5\text{s}</math>.</p> <p>Solder: H63A (JIS Z 3282)</p> <p>Flux: Isopropyl alcohol (JIS K 8839) Rosin (JIS K 5902) 25% solid solution.</p>													
12	<b>Resistance to solder heat</b>		<p>Completely soak both terminations in solder at <math>260 \pm 5^\circ\text{C}</math> for <math>5 \pm 1\text{s}</math>.</p> <p>Preheating condition Temp.: <math>150 \pm 10^\circ\text{C}</math> Time: 1 to 2min.</p> <p>Flux: Isopropyl alcohol (JIS K 8839) Rosin (JIS K 5902) 25% solid solution.</p> <p>Solder: H63A (JIS Z 3282)</p> <p>Leave the capacitor in ambient conditions for 6 to 24h (Class 1) or <math>24 \pm 2\text{h}</math> (Class 2) before measurement.</p>													
	External appearance	No cracks are allowed and terminations shall be covered at least 60% with new solder.														
	Capacitance	<table border="1"> <thead> <tr> <th colspan="2">Characteristics</th> <th>Change from the value before test</th> </tr> </thead> <tbody> <tr> <td>Class 1</td> <td>C0G</td> <td>Capacitance drift within <math>\pm 2.5\%</math> or <math>\pm 0.25\text{pF}</math>, whichever larger.</td> </tr> <tr> <td rowspan="3">Class 2</td> <td>X5R</td> <td><math>\pm 7.5\%</math></td> </tr> <tr> <td>X7R</td> <td><math>\pm 7.5\%</math></td> </tr> <tr> <td>Y5V</td> <td><math>\pm 20\%</math></td> </tr> </tbody> </table>	Characteristics		Change from the value before test	Class 1	C0G	Capacitance drift within $\pm 2.5\%$ or $\pm 0.25\text{pF}$ , whichever larger.	Class 2	X5R	$\pm 7.5\%$	X7R	$\pm 7.5\%$	Y5V	$\pm 20\%$	
Characteristics		Change from the value before test														
Class 1	C0G	Capacitance drift within $\pm 2.5\%$ or $\pm 0.25\text{pF}$ , whichever larger.														
Class 2	X5R	$\pm 7.5\%$														
	X7R	$\pm 7.5\%$														
	Y5V	$\pm 20\%$														
	Q (Class 1)	<table border="1"> <thead> <tr> <th>Rated Capacitance</th> <th>Q</th> </tr> </thead> <tbody> <tr> <td><math>C \geq 30\text{pF}</math></td> <td>1,000 min.</td> </tr> <tr> <td><math>C &lt; 30\text{pF}</math></td> <td><math>400 + 20 \times C</math> min.</td> </tr> </tbody> </table> <p style="text-align: center;">C : Rated capacitance (pF)</p>	Rated Capacitance	Q	$C \geq 30\text{pF}$	1,000 min.	$C < 30\text{pF}$	$400 + 20 \times C$ min.								
Rated Capacitance	Q															
$C \geq 30\text{pF}$	1,000 min.															
$C < 30\text{pF}$	$400 + 20 \times C$ min.															
	D.F. (Class 2)	Meet the initial spec.														
	Insulation Resistance	Meet the initial spec.														
	Voltage Proof	No insulation breakdown or other damage.														



## General Specifications

## C Series – General Application

No.	Item	Performance	Test or Inspection Method		
13	<b>Vibration</b>				
	External appearance	No mechanical damage.	Reflow solder the capacitor on P.C. board (shown in Appendix 1a or Appendix 1b) before testing.		
	Capacitance	<b>Characteristics</b>		Vibrate the capacitor with amplitude of 1.5mm P-P changing the frequencies from 10Hz to 55Hz and back to 10Hz after 1min. Repeat this for 2h each in 3 perpendicular directions.	
		<b>Change from the value before test</b>			
		Class 1	C0G		$\pm 2.5\%$ or $\pm 0.25\text{pF}$ , whichever larger.
		Class 2	X5R X7R Y5V		$\pm 7.5\%$ $\pm 7.5\%$ $\pm 20\%$
	Q (Class 1)	<b>Rated Capacitance</b>		<b>Q</b>	
		$C \geq 30\text{pF}$			1,000 min.
		$C < 30\text{pF}$			$400+20 \times C$ min.
	C : Rated capacitance (pF)				
D.F. (Class 2)	Meet the initial spec.				
14	<b>Temperature cycle</b>				
	External appearance	No mechanical damage.	Reflow solder the capacitor on P.C. board (shown in Appendix 1a or Appendix 1b) before testing.		
	Capacitance	<b>Characteristics</b>		Expose the capacitor in the condition step1 through step 4 and repeat 5 times consecutively.	
		<b>Change from the value before test</b>			
		Class 1	C0G		$\pm 2.5\%$ or $\pm 0.25\text{pF}$ , whichever larger.
		Class 2	X5R X7R Y5V		$\pm 15\%$ $\pm 15\%$ $\pm 20\%$
	Q (Class 1)	<b>Rated Capacitance</b>		<b>Q</b>	
		$C \geq 30\text{pF}$			1,000 min.
		$C < 30\text{pF}$			$400+20 \times C$ min.
	C : Rated capacitance (pF)				
D.F. (Class 2)	Meet the initial spec.				
Insulation Resistance	Meet the initial spec.				
Voltage Proof	No insulation breakdown or other damage.				

Reflow solder the capacitor on P.C. board (shown in Appendix 1a or Appendix 1b) before testing.

Expose the capacitor in the condition step1 through step 4 and repeat 5 times consecutively.

Leave the capacitor in ambient conditions for 6 to 24h (Class 1) or  $24 \pm 2\text{h}$  (Class 2) before measurement.

Step	Temperature (°C)	Time (min.)
1	Min. operating temp. $\pm 3$	$30 \pm 3$
2	Reference Temp.	2 – 5
3	Max. operating temp. $\pm 2$	$30 \pm 2$
4	Reference Temp.	2 - 5



## General Specifications

## C Series – General Application

No.	Item	Performance	Test or Inspection Method														
15	<b>Moisture Resistance (Steady State)</b>		Reflow solder the capacitor on P.C. board (shown in Appendix 1a or Appendix 1b) before testing.  Leave at temperature $40 \pm 2^\circ\text{C}$ , 90 to 95%RH for 500 +24,0h.  Leave the capacitor in ambient conditions for 6 to 24h (Class 1) or $24 \pm 2\text{h}$ (Class 2) before measurement.														
	External appearance	No mechanical damage.															
	Capacitance	<table border="1"> <thead> <tr> <th colspan="2">Characteristics</th> <th>Change from the value before test</th> </tr> </thead> <tbody> <tr> <td>Class 1</td> <td>C0G</td> <td><math>\pm 5\%</math> or <math>\pm 0.5\text{pF}</math>, whichever larger.</td> </tr> <tr> <td rowspan="3">Class 2</td> <td>X5R</td> <td><math>\pm 25\%</math></td> </tr> <tr> <td>X7R</td> <td><math>\pm 25\%</math></td> </tr> <tr> <td>Y5V</td> <td><math>\pm 30\%</math></td> </tr> </tbody> </table>		Characteristics		Change from the value before test	Class 1	C0G	$\pm 5\%$ or $\pm 0.5\text{pF}$ , whichever larger.	Class 2	X5R	$\pm 25\%$	X7R	$\pm 25\%$	Y5V	$\pm 30\%$	
		Characteristics		Change from the value before test													
		Class 1		C0G	$\pm 5\%$ or $\pm 0.5\text{pF}$ , whichever larger.												
Class 2	X5R	$\pm 25\%$															
	X7R	$\pm 25\%$															
	Y5V	$\pm 30\%$															
Q (Class 1)	<table border="1"> <thead> <tr> <th>Rated Capacitance</th> <th>Q</th> </tr> </thead> <tbody> <tr> <td><math>C \geq 30\text{pF}</math></td> <td>350 min.</td> </tr> <tr> <td><math>10\text{pF} \leq C &lt; 30\text{pF}</math></td> <td><math>275 + 5/2 \times C</math> min.</td> </tr> <tr> <td><math>C &lt; 10\text{pF}</math></td> <td><math>200 + 10 \times C</math> min.</td> </tr> </tbody> </table>		Rated Capacitance	Q	$C \geq 30\text{pF}$	350 min.	$10\text{pF} \leq C < 30\text{pF}$	$275 + 5/2 \times C$ min.	$C < 10\text{pF}$	$200 + 10 \times C$ min.							
	Rated Capacitance	Q															
	$C \geq 30\text{pF}$	350 min.															
	$10\text{pF} \leq C < 30\text{pF}$	$275 + 5/2 \times C$ min.															
$C < 10\text{pF}$	$200 + 10 \times C$ min.																
C : Rated capacitance (pF)																	
D.F. (Class 2)	Characteristics X5R: 200% of initial spec. max. X7R: 200% of initial spec. max Y5V: 150% of initial spec. max																
Insulation Resistance	1,000M $\Omega$ or 50M $\Omega \cdot \mu\text{F}$ min. (As for the capacitors of rated voltage 16, 10 and 6.3V DC, 1,000 M $\Omega$ or 10M $\Omega \cdot \mu\text{F}$ min.,) whichever smaller.																



## General Specifications

# C Series – General Application

No.	Item	Performance	Test or Inspection Method													
16	<b>Moisture Resistance</b>															
	External appearance	No mechanical damage.	Reflow solder the capacitor on P.C. board (shown in Appendix 1a or Appendix 1b) before testing. Apply the rated voltage at temperature $40 \pm 2^\circ\text{C}$ and 90 to 95%RH for 500 +24,0h.													
	Capacitance	<table border="1"> <thead> <tr> <th colspan="2">Characteristics</th> <th>Change from the value before test</th> </tr> </thead> <tbody> <tr> <td>Class 1</td> <td>C0G</td> <td><math>\pm 7.5\%</math> or <math>\pm 0.75\text{pF}</math>, whichever larger.</td> </tr> <tr> <td rowspan="3">Class 2</td> <td>X5R</td> <td><math>\pm 25\%</math></td> </tr> <tr> <td>X7R</td> <td><math>\pm 25\%</math></td> </tr> <tr> <td>Y5V</td> <td><math>\pm 30\%</math> *(<math>\pm 40\%</math>)</td> </tr> </tbody> </table>	Characteristics		Change from the value before test	Class 1	C0G	$\pm 7.5\%$ or $\pm 0.75\text{pF}$ , whichever larger.	Class 2	X5R	$\pm 25\%$	X7R	$\pm 25\%$	Y5V	$\pm 30\%$ *( $\pm 40\%$ )	Charge/discharge current shall not exceed 50mA. Leave the capacitor in ambient conditions for 6 to 24h (Class 1) or $24 \pm 2\text{h}$ (Class 2) before measurement.
		Characteristics		Change from the value before test												
Class 1	C0G	$\pm 7.5\%$ or $\pm 0.75\text{pF}$ , whichever larger.														
Class 2	X5R	$\pm 25\%$														
	X7R	$\pm 25\%$														
	Y5V	$\pm 30\%$ *( $\pm 40\%$ )														
Q (Class 1)	<table border="1"> <thead> <tr> <th>Rated Capacitance</th> <th>Q</th> </tr> </thead> <tbody> <tr> <td><math>C \geq 30\text{pF}</math></td> <td>200 min.</td> </tr> <tr> <td><math>C &lt; 30\text{pF}</math></td> <td><math>100 + 10/3 \times C</math> min.</td> </tr> </tbody> </table> <p style="text-align: center;">C : Rated capacitance (pF)</p>	Rated Capacitance	Q	$C \geq 30\text{pF}$	200 min.	$C < 30\text{pF}$	$100 + 10/3 \times C$ min.	Voltage conditioning (only for Class 2): Voltage treat the capacitor under testing temperature and voltage for 1 hour. Leave the capacitor in ambient conditions for $24 \pm 2\text{h}$ before measurement. Use this measurement for initial value.								
Rated Capacitance	Q															
$C \geq 30\text{pF}$	200 min.															
$C < 30\text{pF}$	$100 + 10/3 \times C$ min.															
D.F. (Class 2)	Characteristics X5R: 200% of initial spec. max. X7R: 200% of initial spec. max Y5V: 150% of initial spec. max															
Insulation Resistance	500M $\Omega$ or 25M $\Omega \cdot \mu\text{F}$ min., whichever smaller. (As for the capacitors of rated voltage 16, 10 and 6.3V DC, 500 M $\Omega$ or 5M $\Omega \cdot \mu\text{F}$ min.,)															



## General Specifications

## C Series – General Application

No.	Item	Performance	Test or Inspection Method	
17	<b>Life</b>			
	External appearance	No mechanical damage.	Reflow solder the capacitor on P.C. board (shown in Appendix 1a or Appendix 1b) before testing. Apply voltage at 125±2°C for 1,000 +48, 0h.	
	Capacitance	<b>Characteristics</b>	<b>Change from the value before test</b>	Applied voltage is 1xRV. Some items may be tested at higher voltage (1.2x, 1.5x or 2xRV). Charge/discharge current shall not exceed 50mA.
		Class 1	C0G	±3% or ±0.3pF, whichever larger.
	Class 2	X5R X7R Y5V	± 25 % ± 25 % ± 30 % *(± 40 %)	
		* Inside ( ) is applied to Y5V 6.3V product.		
	Q (Class 1)	<b>Rated Capacitance</b>	<b>Q</b>	
		C ≥ 30pF	350 min.	
		10pF ≤ C < 30pF	275+5/2 × C min.	
		C < 10pF	200+10 × C min.	
		C : Rated capacitance (pF)		
	D.F. (Class 2)	Characteristics X5R: 200% of initial spec. max. X7R: 200% of initial spec. max Y5V: 150% of initial spec. max	Leave the capacitors in ambient condition for 6 to 24h (Class 1) or 24±2h (Class 2) before measurement. Voltage conditioning (only for class 2) Voltage treat the capacitor under testing temperature and voltage for 1 hour.	
	Insulation Resistance	1,000MΩ or 50MΩ·μF min. , whichever smaller. (As for the capacitors of rated voltage 16, 10 and 6.3V DC, 1,000 MΩ or 10MΩ·μF min.,)	Leave the capacitor in ambient conditions for 24±2h before measurement. Use this measurement for initial value.	

\*As for the initial measurement of capacitors (Class2) on number 8,12,13,14 and 15, leave capacitor at 150 –10, 0°C for 1 hour and measure the value after leaving capacitor for 24±2h in ambient conditions.



# General Specifications

# C Series – General Application

## Appendix - 1a

### P.C. Board for reliability test

Applied for C0603, C1005, C1608, C2012, C3216

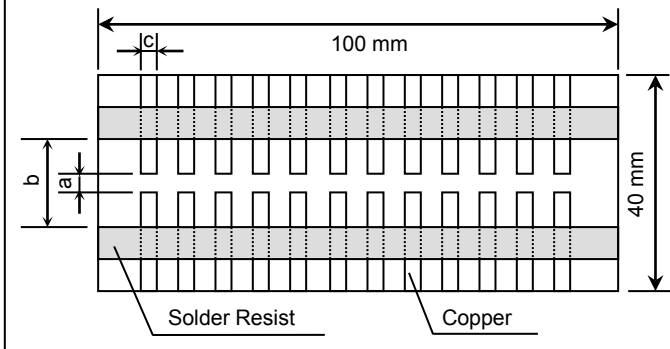

## Appendix - 1b

### P.C. Board for reliability test

Applied for C3225, C4532, C5750

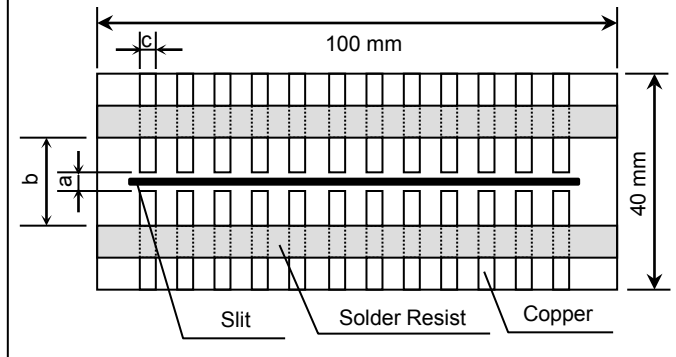

## Appendix - 2a

### P.C. Board for bending test

Applied for C0603, C1005

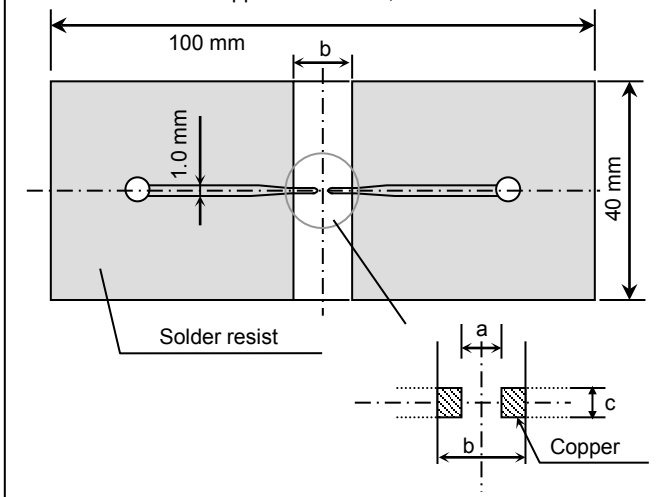

## Appendix - 2b

### P.C. Board for bending test

Applied for C1608, C2012, C3216, C3225, C4532, C5750

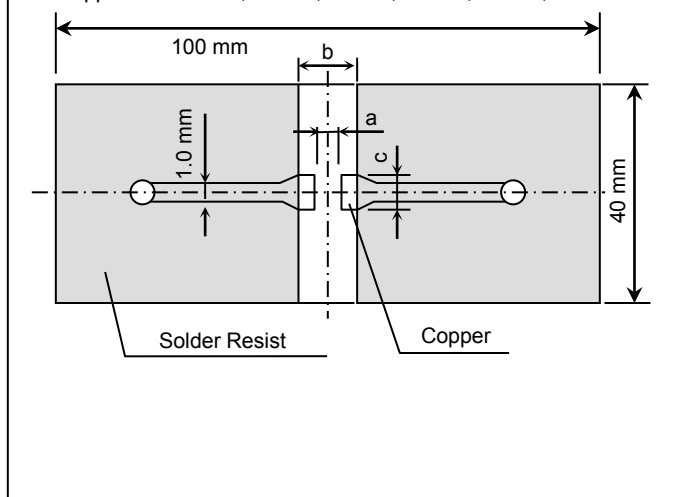

Material: Glass Epoxy (As per JIS C6484 GE4)

P.C. Board thickness: Appendix-2a 0.8mm  
Appendix-1a, 1b, 2b 1.6mm

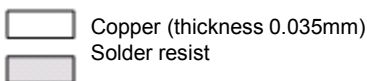

Case Code		Dimensions (mm)		
JIS	EIA	a	b	c
C0603	CC0201	0.3	0.8	0.3
C1005	CC0402	0.4	1.5	0.5
C1608	CC0603	1.0	3.0	1.2
C2012	CC0805	1.2	4.0	1.65
C3216	CC1206	2.2	5.0	2.0
C3225	CC1210	2.2	5.0	2.9
C4532	CC1812	3.5	7.0	3.7
C5750	CC2220	4.5	8.0	5.6

## Information

# C Series – General Application

### Recommended Soldering Land Pattern

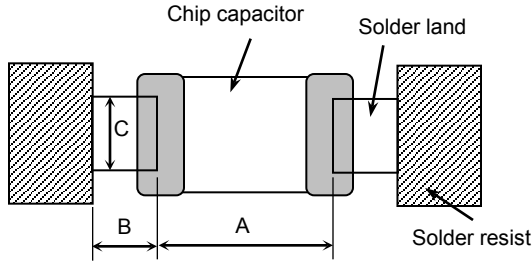

### Recommended Soldering Profile

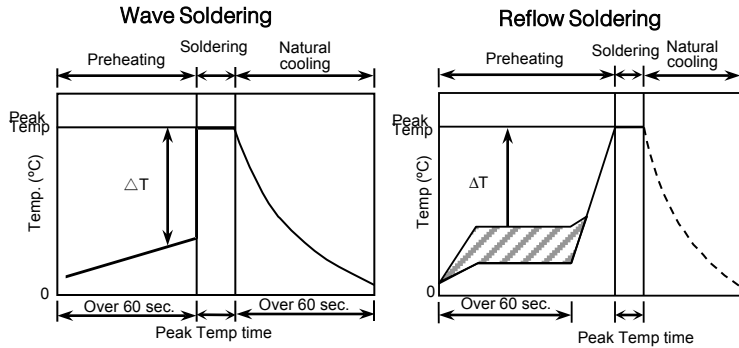

### Manual soldering (Solder iron)

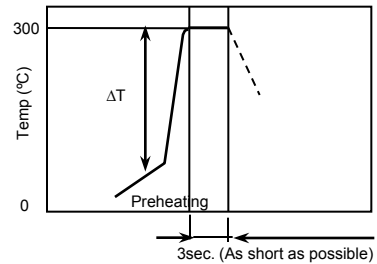

**Wave Soldering** Unit: mm

Type	C1608 [CC0603]	C2012 [CC0805]	C3216 [CC1206]
A	0.7 - 1.0	1.0 - 1.3	2.1 - 2.5
B	0.8 - 1.0	1.0 - 1.2	1.1 - 1.3
C	0.6 - 0.8	0.8 - 1.1	1.0 - 1.3

**Reflow Soldering** Unit: mm

Type	C0603 [CC0201]	C1005 [CC0402]	C1608 [CC0603]	C2012 [CC0805]
A	0.25 - 0.35	0.3 - 0.5	0.6 - 0.8	0.9 - 1.2
B	0.2 - 0.3	0.35 - 0.45	0.6 - 0.8	0.7 - 0.9
C	0.25 - 0.35	0.4 - 0.6	0.6 - 0.8	0.9 - 1.2

**Reflow Soldering** Unit: mm

Type	C3216 [CC1206]	C3225 [CC1210]	C4532 [CC1812]	C5750 [CC2220]
A	2.0 - 2.4	2.0 - 2.4	3.1 - 3.7	4.1 - 4.8
B	1.0 - 1.2	1.0 - 1.2	1.2 - 1.4	1.2 - 1.4
C	1.1 - 1.6	1.9 - 2.5	2.4 - 3.2	4.0 - 5.0

### Recommended soldering duration

Solder	Temp./ Dura.	Wave Soldering		Reflow Soldering	
		Peak temp (°C)	Duration (sec.)	Peak temp (°C)	Duration (sec.)
Sn-Pb Solder		250 max.	3 max.	230 max.	20 max.
Lead-Free Solder		260 max.	5 max.	260 max.	10 max.

### Recommended solder compositions

- Sn-37Pb (Sn-Pb solder)
- Sn-3.0Ag-0.5Cu (Lead Free Solder)

### Preheating Condition

Soldering	Case Size - JIS (EIA)	Temp. (°C)
Wave soldering	C1608(CC0603), C2012(CC0805), C3216(CC1206)	$\Delta T \leq 150$
	C0603(CC0201), C1005(CC0402), C1608(CC0603), C2012(CC0805), C3216(CC1206)	$\Delta T \leq 150$
Reflow soldering	C3225(CC1210), C4532(CC1812), C5750(CC2220)	$\Delta T \leq 130$
	C0603(CC0201), C1005(CC0402), C1608(CC0603), C2012(CC0805), C3216(CC1206)	$\Delta T \leq 150$
Manual soldering	C3225(CC1210), C4532(CC1812), C5750(CC2220)	$\Delta T \leq 130$

### Recommended Solder Amount

Excessive solder Higher tensile force on the chip capacitor may cause cracking.

Adequate solder Maximum amount  
Minimum amount

Insufficient solder Small solder fillet may cause contact failure or failure to hold the chip capacitor to the P.C. board.



## Packaging Information

# C Series – General Application

### Carrier Tape Configuration

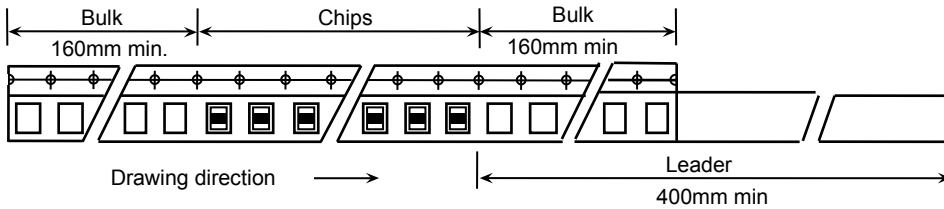

### Peel Back Force (Top Tape)

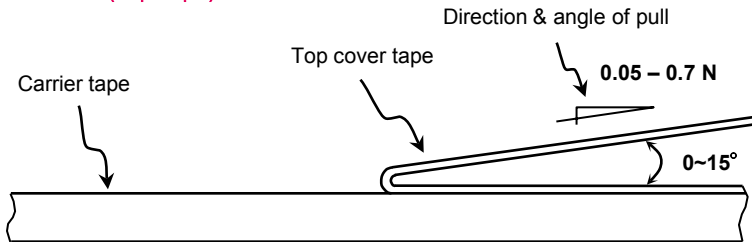

- Carrier tape shall be flexible enough to be wound around a minimum radius of 30mm with components in tape.
- The missing of components shall be less than 0.1%
- Components shall not stick to the cover tape.
- The cover tape shall not protrude beyond the edges of the carrier tape not shall cover the sprocket holes.

### Chip Quantity Per Reel and Structure of Reel (Paper & Plastic)

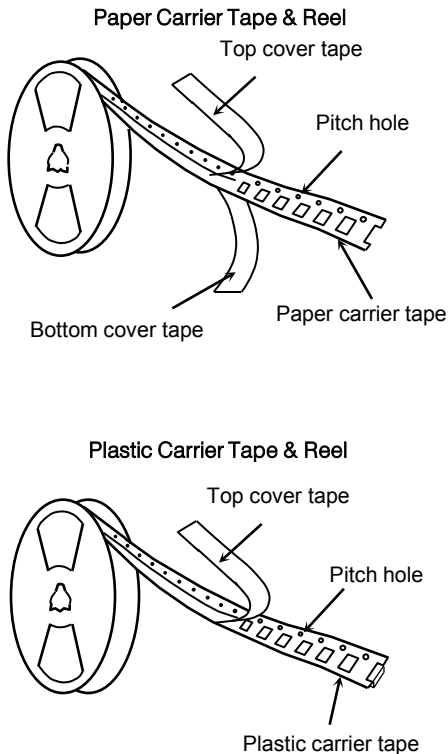

Case Code		Chip Thickness	Taping Material	Chip quantity (pcs.)			
JIS	EIA			φ178mm (7") reel	φ330mm (13") reel		
C0402	CC01005	0.20 mm	Paper	20,000	-		
C0603	CC0201	0.30 mm	Paper	15,000	-		
C1005	CC0402	0.50 mm	Paper	10,000	50,000		
C1608	CC0603	0.80 mm	Paper	4,000	10,000		
C2012	CC0805	0.60 mm	Paper/Plastic	4,000	20,000		
		0.85 mm			10,000		
		1.25 mm	Plastic		2,000		
C3216	CC1206	0.60 mm	Paper	4,000	10,000		
		0.85 mm	Paper/Plastic				
		1.15 mm	Plastic			2,000	
		1.30 mm					
		1.60 mm					
C3225	CC1210	1.15 mm	Plastic	2,000	10,000		
		1.25 mm					
		1.30 mm					
		1.60 mm					
		2.00 mm				1,000	5,000
		2.30 mm					
		2.50 mm					
C4532	CC1812	1.60 mm	Plastic	1,000	3,000		
		2.00 mm					
		2.30 mm					
		2.50 mm					
		2.80 mm				500	2,000
3.20 mm							
C5750	CC2220	2.00 mm	Plastic	500	3,000		
		2.30 mm					
		2.50 mm					
		2.80 mm				2,000	



## Additional Information

# C Series – General Application

### • Shape & Dimensions

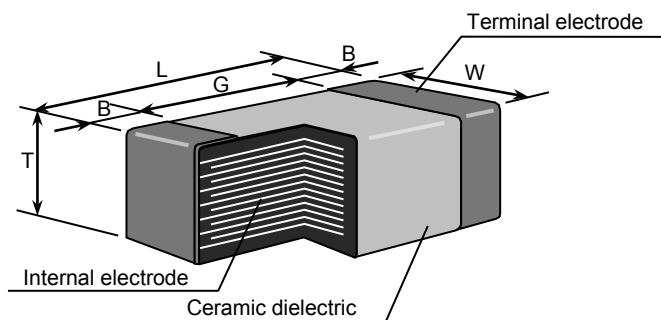

### • Inside Structure & Material System

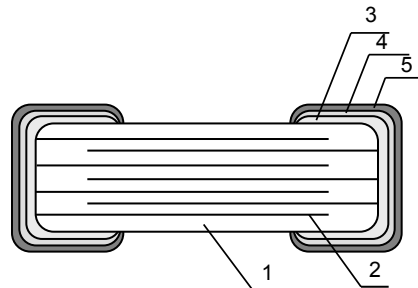

Case Code		Dimensions (mm)				
JIS	EIA	L	W	T	B	G
C0402	CC01005	0.40	0.20	0.20	0.10	0.13 min.
C0603	CC0201	0.60	0.30	0.30	0.15	0.20 min.
C1005	CC0402	1.00	0.50	0.50	0.25	0.35 min.
C1608	CC0603	1.60	0.80	0.50	0.30	0.50 min.
				0.80	0.20 min.	
C2012	CC0805	2.00	1.20	0.60	0.20 min.	0.50 min.
				0.80		
				0.85		
				1.25		
C3216	CC1206	3.20	1.60	0.60	0.20 min.	1.00 min.
				0.85		
				1.15		
				1.30		
				1.60		
C3225	CC1210	3.20	2.50	1.15	0.20 min.	1.00 min.
				1.25	0.30 min.	
				1.30		
				1.60	0.20 min.	
				2.00	0.30 min.	
				2.30		
2.50						
C4532	CC1812	4.50	3.20	1.30	0.30 min.	2.00 min.
				1.60	0.20 min.	
				2.00		
				2.30	0.30 min.	
				2.50		
				2.80		
3.20						
C5750	CC2220	5.70	5.0	1.60	0.20 min.	2.00 min.
				2.00		
				2.30		
				2.50		
				2.80		

No.	NAME	MATERIAL	
		Class 1	Class 2
(1)	Ceramic Dielectric	CaZrO <sub>3</sub>	BaTiO <sub>3</sub>
(2)	Internal Electrode	Nickel (Ni)	
(3)	Termination	Copper (Cu)	
(4)		Nickel (Ni)	
(5)		Tin (Sn)	

### • Environmental Information

TDK Corporation established internal product environmental assurance standards that include the six hazardous substances banned by the EU RoHS Directive<sup>1</sup> enforced on July 1, 2006 along with additional substances independently banned by TDK and has successfully completed making general purpose electronic components conform to the RoHS Directive<sup>2</sup>.

1. Abbreviation for Restriction on Hazardous Substances, which refers to the regulation EU Directive 2002/95/EC on hazardous substances by the European Union (EU) effective from July 1, 2006. The Directive bans the use of six specific hazardous substances in electric and electronic devices and products handled within the EU. The six substances are lead, mercury, cadmium, hexavalent chromium, PBB (polybrominated biphenyls), and PBDE (polybrominated diphenyl ethers).
2. This means that, in conformity with the EU Directive 2002/95/EC, lead, cadmium, mercury, hexavalent chromium, and specific bromine-based flame retardants, PBB and PBDE, have not been used, except for exempted applications.

For REACH (SVHC : 15 substances according to ECHA / October 2008) : All TDK MLCC do not contain these 15 substances.

For European Directive 2000/53/CE and 2005/673/CE : Cadmium, Hexavalent Chromium, Mercury, Lead are not contained in all TDK MLCC.

For European Directive 2003/11/CE : Pentabromodiphenyl-ether, Octabromodiphenyl-ether are not contained in all TDK MLCC.

## OUR CERTIFICATE

DiGi provide top-quality products and perfect service for customer worldwide through standardization, technological innovation and continuous improvement. DiGi through third-party certification, we stricly control the quality of products and services. Welcome your RFQ to

Email: [Info@DiGi-Electronics.com](mailto:Info@DiGi-Electronics.com)

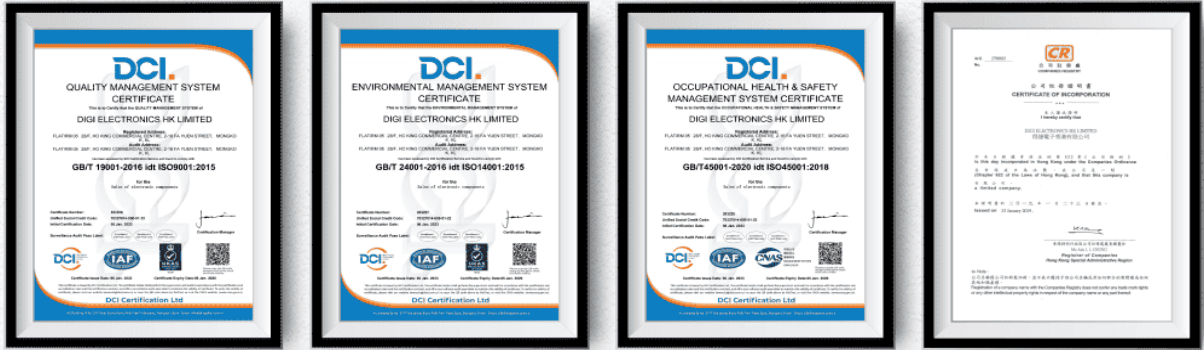

Tel: +00 852-30501935

RFQ Email: [Info@DiGi-Electronics.com](mailto:Info@DiGi-Electronics.com)

DiGi is a global authorized distributor of electronic components.