

MLF1608A2R2KTA00 Datasheet

www.digi-electronics.com

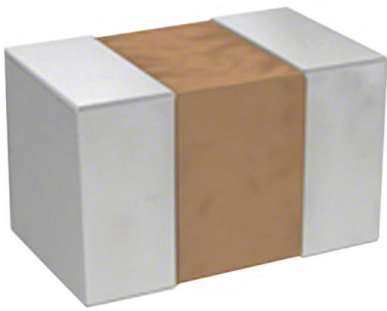

<https://www.DiGi-Electronics.com>

DiGi Electronics Part Number	MLF1608A2R2KTA00-DG
Manufacturer	TDK Corporation
Manufacturer Product Number	MLF1608A2R2KTA00
Description	FIXED IND 2.2UH 30MA 1 OHM SMD
Detailed Description	2.2 μ H Shielded Multilayer Inductor 30 mA 10hm M ax 0603 (1608 Metric)



Tel: +00 852-30501935

RFQ Email: Info@DiGi-Electronics.com

DiGi is a global authorized distributor of electronic components.

Purchase and inquiry

Manufacturer Product Number:

MLF1608A2R2KTA00

Series:

MLF

Type:

Multilayer

Inductance:2.2 μ H**Current Rating (Amps):**

30 mA

Shielding:

Shielded

Q @ Freq:

35 @ 10MHz

Ratings:

-

Inductance Frequency - Test:

10 MHz

Package / Case:

0603 (1608 Metric)

Size / Dimension:

0.063" L x 0.031" W (1.60mm x 0.80mm)

Manufacturer:

TDK Corporation

Product Status:

Active

Material - Core:

Ferrite

Tolerance: \pm 10%**Current - Saturation (Isat):**

-

DC Resistance (DCR):

10hm Max

Frequency - Self Resonant:

80MHz

Operating Temperature:

-40°C ~ 85°C

Mounting Type:

Surface Mount

Supplier Device Package:

0603 (1608 Metric)

Height - Seated (Max):

0.037" (0.95mm)

Environmental & Export classification

RoHS Status:

ROHS3 Compliant

REACH Status:

REACH Unaffected

HTSUS:

8504.50.8000

Moisture Sensitivity Level (MSL):

1 (Unlimited)

ECCN:

EAR99

Inductors for standard circuits

Multilayer ferrite

MLF series



MLF1608 type



FEATURES

- The lineup includes a wide inductance range.
- Highly reliable monolithic structure with multilayer integration.
- Operating temperature range: -55 to +125°C

APPLICATION

- Smart phones, tablet terminals, tuners, LCD-TVs, PDP-TVs, audio equipment, computers, signal processing for modules etc.
- Application guides: [Smart phones/tablets](#)

PART NUMBER CONSTRUCTION

MLF	1608	D	47N	△	T	000
Series name	LxWxH dimensions 1.6x0.8x0.8 mm	Characteristics	Inductance (μ H)	Inductance tolerance	Packaging style	Internal code

* The "△" of the Part Number contains the inductance tolerance code, J ($\pm 5\%$), K ($\pm 10\%$), or M ($\pm 20\%$).

CHARACTERISTICS SPECIFICATION TABLE

L (μ H)	Q Tolerance	L, Q measuring conditions		Self-resonant frequency		DC resistance		Rated current (mA)max.	Part No.*		
		min.	typ.	Frequency (MHz)	Current (mA)	(MHz)min.	(MHz)typ.			(Ω)max.	(Ω)typ.
0.047	$\pm 20\%$	10	20	50	1.0	600	900	0.20	0.10	200	MLF1608D47NMTA00
0.068	$\pm 20\%$	10	20	50	1.0	550	700	0.30	0.15	200	MLF1608D68NMTA00
0.082	$\pm 20\%$	10	20	50	1.0	500	650	0.30	0.15	200	MLF1608D82NMTA00
0.10	$\pm 5\%$	15	25	25	1.0	450	600	0.35	0.20	200	MLF1608DR10JT000
	$\pm 10\%$										MLF1608DR10KTA00
	$\pm 20\%$										MLF1608DR10MTA00
0.12	$\pm 5\%$	15	25	25	1.0	400	550	0.40	0.20	200	MLF1608DR12JT000
	$\pm 10\%$										MLF1608DR12KTA00
	$\pm 20\%$										MLF1608DR12MTA00
0.15	$\pm 5\%$	15	25	25	1.0	350	500	0.45	0.25	200	MLF1608DR15JT000
	$\pm 10\%$										MLF1608DR15KTA00
	$\pm 20\%$										MLF1608DR15MTA00
0.18	$\pm 5\%$	15	25	25	1.0	320	450	0.50	0.25	150	MLF1608DR18JT000
	$\pm 10\%$										MLF1608DR18KTA00
	$\pm 20\%$										MLF1608DR18MTA00
0.22	$\pm 5\%$	15	25	25	1.0	290	400	0.55	0.30	150	MLF1608DR22JT000
	$\pm 10\%$										MLF1608DR22KTA00
	$\pm 20\%$										MLF1608DR22MTA00
0.27	$\pm 5\%$	15	25	25	1.0	260	350	0.60	0.35	150	MLF1608DR27JT000
	$\pm 10\%$										MLF1608DR27KTA00
	$\pm 20\%$										MLF1608DR27MTA00

Measurement equipment

Measurement item	Product No.	Manufacturer
L, Q	4294A+16034G	Keysight Technologies
Self-resonant frequency	E4991A	Keysight Technologies
DC resistance	Type-7561	Yokogawa

* Equivalent measurement equipment may be used.

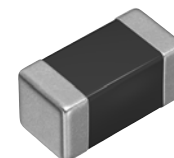

⚠ Please be sure to request delivery specifications that provide further details on the features and specifications of the products for proper and safe use.
Please note that the contents may change without any prior notice due to reasons such as upgrading.

(1/9)

20190111

inductor_commercial_standard_mlf1608_en

MLF1608 type

CHARACTERISTICS SPECIFICATION TABLE

L (μ H)	Tolerance	Q		L, Q measuring conditions		Self-resonant frequency		DC resistance		Rated current (mA)max.	Part No.*
		min.	typ.	Frequency (MHz)	Current (mA)	(MHz)min.	(MHz)typ.	(Ω)max.	(Ω)typ.		
0.33	$\pm 5\%$	15	25	25	1.0	230	320	0.75	0.40	100	MLF1608DR33JT000
	$\pm 10\%$										MLF1608DR33KTA00
	$\pm 20\%$										MLF1608DR33MTA00
0.39	$\pm 5\%$	15	25	25	1.0	210	290	0.85	0.45	100	MLF1608DR39JT000
	$\pm 10\%$										MLF1608DR39KTA00
	$\pm 20\%$										MLF1608DR39MTA00
0.47	$\pm 5\%$	15	30	25	1.0	190	260	0.95	0.50	100	MLF1608DR47JT000
	$\pm 10\%$										MLF1608DR47KTA00
	$\pm 20\%$										MLF1608DR47MTA00
0.56	$\pm 5\%$	15	30	25	1.0	170	230	1.05	0.55	100	MLF1608DR56JT000
	$\pm 10\%$										MLF1608DR56KTA00
	$\pm 20\%$										MLF1608DR56MTA00
0.68	$\pm 5\%$	15	30	25	1.0	150	210	1.25	0.65	70	MLF1608DR68JT000
	$\pm 10\%$										MLF1608DR68KTA00
	$\pm 20\%$										MLF1608DR68MTA00
0.82	$\pm 5\%$	15	30	25	1.0	130	190	1.40	0.75	70	MLF1608DR82JT000
	$\pm 10\%$										MLF1608DR82KTA00
	$\pm 20\%$										MLF1608DR82MTA00
1.0	$\pm 5\%$	35	50	10	1.0	120	170	0.50	0.25	50	MLF1608A1R0JT000
	$\pm 10\%$										MLF1608A1R0KTA00
	$\pm 20\%$										MLF1608A1R0MTA00
1.2	$\pm 5\%$	35	50	10	1.0	110	150	0.65	0.25	50	MLF1608A1R2JT000
	$\pm 10\%$										MLF1608A1R2KTA00
	$\pm 20\%$										MLF1608A1R2MTA00
1.5	$\pm 5\%$	35	55	10	1.0	100	140	0.70	0.30	50	MLF1608A1R5JT000
	$\pm 10\%$										MLF1608A1R5KTA00
	$\pm 20\%$										MLF1608A1R5MTA00
1.8	$\pm 5\%$	35	55	10	1.0	90	130	0.85	0.35	50	MLF1608A1R8JT000
	$\pm 10\%$										MLF1608A1R8KTA00
	$\pm 20\%$										MLF1608A1R8MTA00
2.2	$\pm 5\%$	35	55	10	1.0	80	120	1.00	0.45	30	MLF1608A2R2JT000
	$\pm 10\%$										MLF1608A2R2KTA00
	$\pm 20\%$										MLF1608A2R2MTA00
2.7	$\pm 5\%$	35	55	10	1.0	70	110	1.15	0.50	30	MLF1608A2R7JT000
	$\pm 10\%$										MLF1608A2R7KTA00
	$\pm 20\%$										MLF1608A2R7MTA00
3.3	$\pm 5\%$	35	60	10	1.0	65	100	1.30	0.55	30	MLF1608A3R3JT000
	$\pm 10\%$										MLF1608A3R3KTA00
	$\pm 20\%$										MLF1608A3R3MTA00
3.9	$\pm 5\%$	35	60	10	1.0	60	90	1.45	0.65	30	MLF1608A3R9JT000
	$\pm 10\%$										MLF1608A3R9KTA00
	$\pm 20\%$										MLF1608A3R9MTA00
4.7	$\pm 5\%$	35	60	10	1.0	55	80	1.60	0.75	30	MLF1608A4R7JT000
	$\pm 10\%$										MLF1608A4R7KTA00
	$\pm 20\%$										MLF1608A4R7MTA00
5.6	$\pm 5\%$	35	60	4	0.1	45	70	1.10	0.55	15	MLF1608E5R6JT000
	$\pm 10\%$										MLF1608E5R6KTA00
	$\pm 20\%$										MLF1608E5R6MTA00
6.8	$\pm 5\%$	35	60	4	0.1	40	60	1.30	0.65	15	MLF1608E6R8JT000
	$\pm 10\%$										MLF1608E6R8KTA00
	$\pm 20\%$										MLF1608E6R8MTA00

Measurement equipment

Measurement item	Product No.	Manufacturer
L, Q	4294A+16034G	Keysight Technologies
Self-resonant frequency	E4991A	Keysight Technologies
DC resistance	Type-7561	Yokogawa

* Equivalent measurement equipment may be used.

MLF1608 type

CHARACTERISTICS SPECIFICATION TABLE

L (μ H)	Tolerance	Q		L, Q measuring conditions		Self-resonant frequency		DC resistance		Rated current (mA)max.	Part No.*
		min.	typ.	Frequency (MHz)	Current (mA)	(MHz)min.	(MHz)typ.	(Ω)max.	(Ω)typ.		
8.2	$\pm 5\%$ $\pm 10\%$ $\pm 20\%$	35	60	4	0.1	35	55	1.50	0.80	10	MLF1608E8R2JT000 MLF1608E8R2KTA00 MLF1608E8R2MTA00
10	$\pm 5\%$ $\pm 10\%$ $\pm 20\%$	30	55	2	0.1	30	50	1.70	1.00	10	MLF1608E100JT000 MLF1608E100KTD00 MLF1608E100MTD00
12	$\pm 5\%$ $\pm 10\%$ $\pm 20\%$	30	55	2	0.1	25	45	1.80	1.20	10	MLF1608E120JT000 MLF1608E120KTD00 MLF1608E120MTD00
15	$\pm 10\%$ $\pm 20\%$	20	40	1	0.1	22	42	1.50	0.80	2	MLF1608C150KTA00 MLF1608C150MTA00
18	$\pm 10\%$ $\pm 20\%$	20	40	1	0.1	20	40	1.60	0.85	2	MLF1608C180KTA00 MLF1608C180MTA00
22	$\pm 10\%$ $\pm 20\%$	20	40	1	0.1	18	38	1.70	0.90	2	MLF1608C220KTA00 MLF1608C220MTA00
27	$\pm 10\%$ $\pm 20\%$	20	40	1	0.1	15	35	1.80	1.20	2	MLF1608C270KTD00 MLF1608C270MTD00
33	$\pm 10\%$ $\pm 20\%$	20	40	1	0.1	10	30	2.20	1.40	2	MLF1608C330KTD00 MLF1608C330MTD00

Measurement equipment

Measurement item	Product No.	Manufacturer
L, Q	4294A+16034G	Keysight Technologies
Self-resonant frequency	E4991A	Keysight Technologies
DC resistance	Type-7561	Yokogawa

* Equivalent measurement equipment may be used.

MLF1608 type

L FREQUENCY CHARACTERISTICS

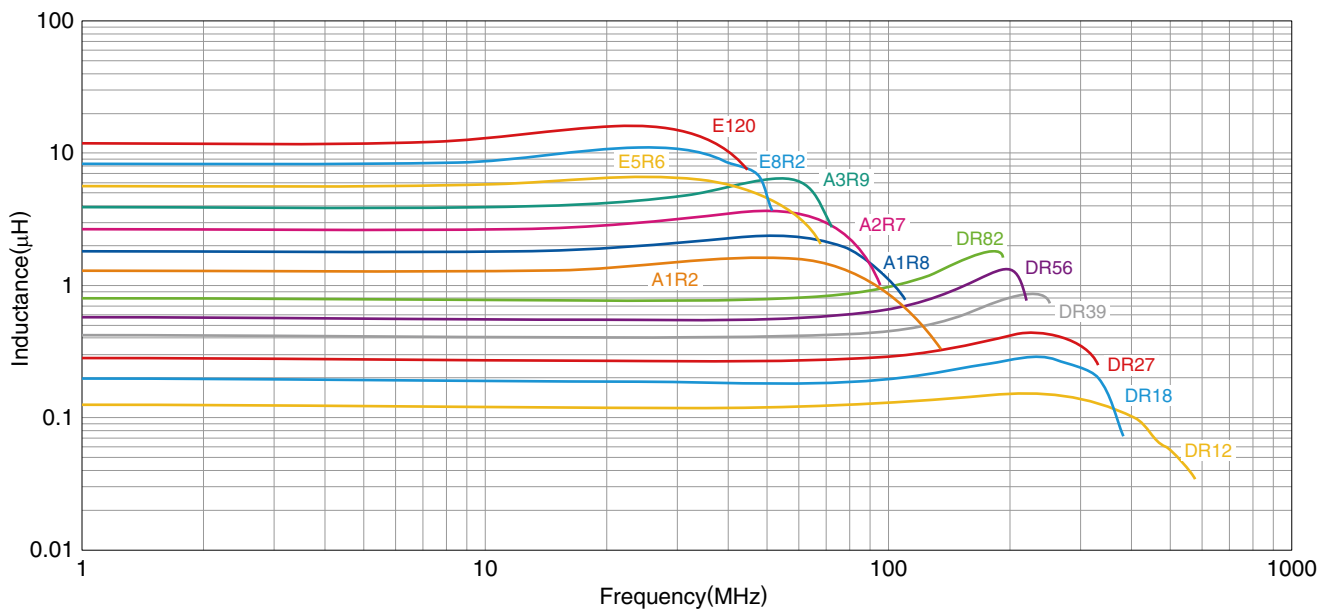
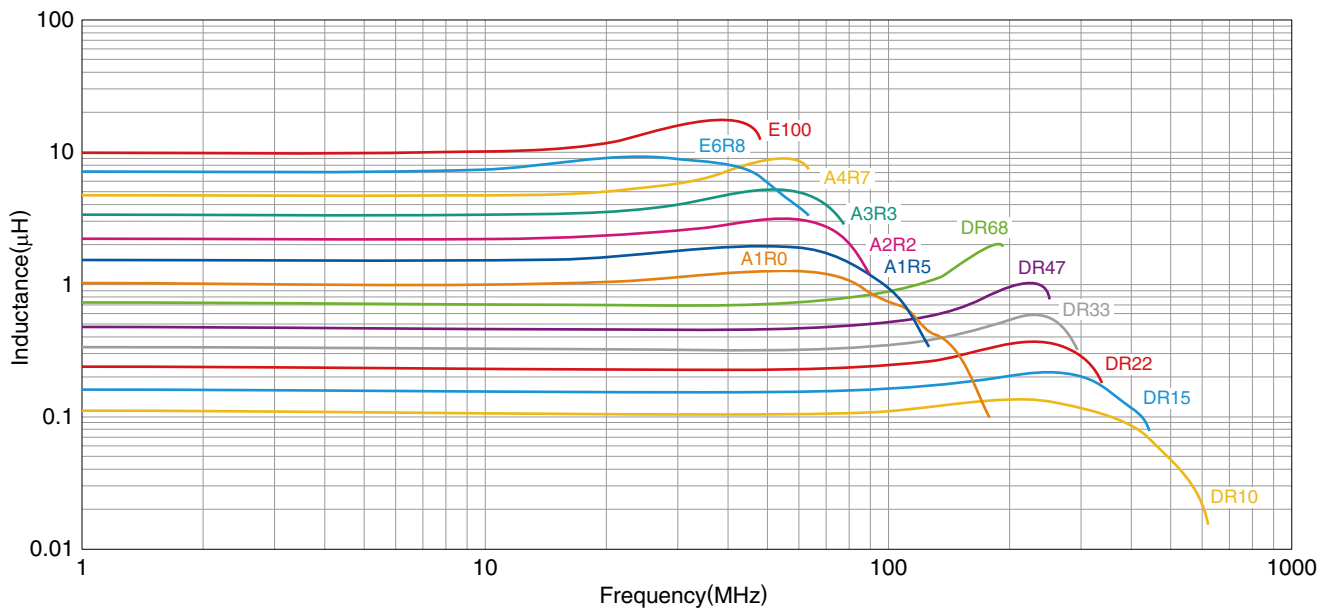

Measurement equipment

Product No.	Manufacturer
E4991A+16192A	Keysight Technologies

* Equivalent measurement equipment may be used.

MLF1608 type

L FREQUENCY CHARACTERISTICS

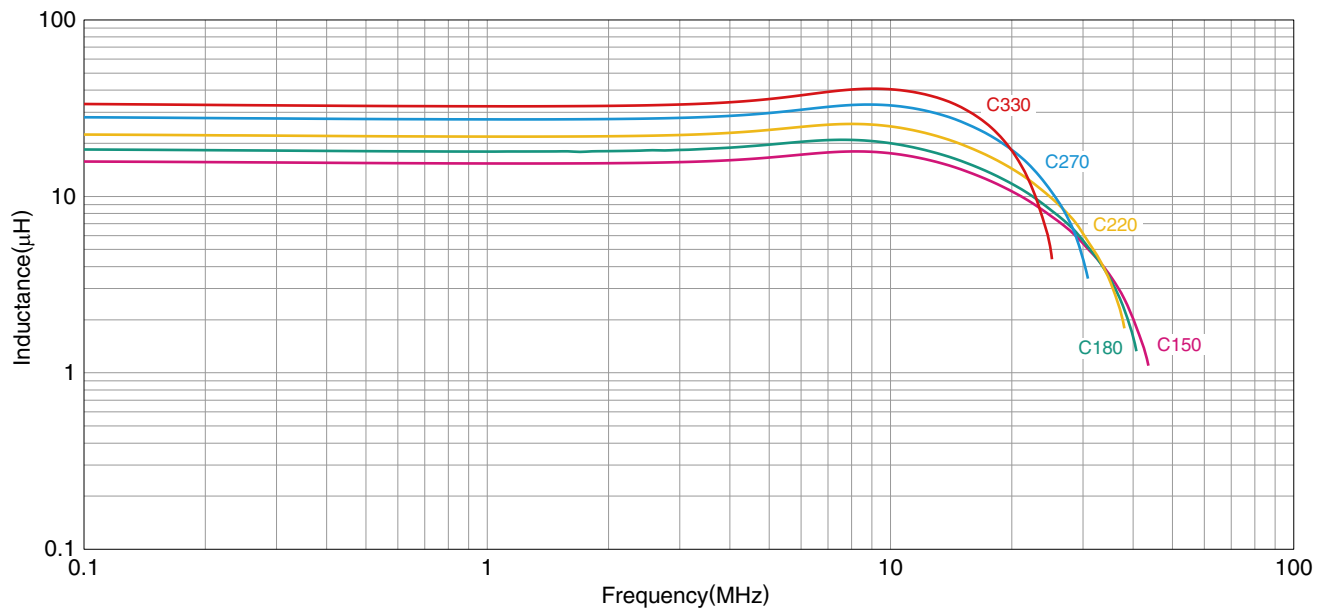

Measurement equipment

Product No.	Manufacturer
4294A+16034G	Keysight Technologies

* Equivalent measurement equipment may be used.

MLF1608 type

Q FREQUENCY CHARACTERISTICS

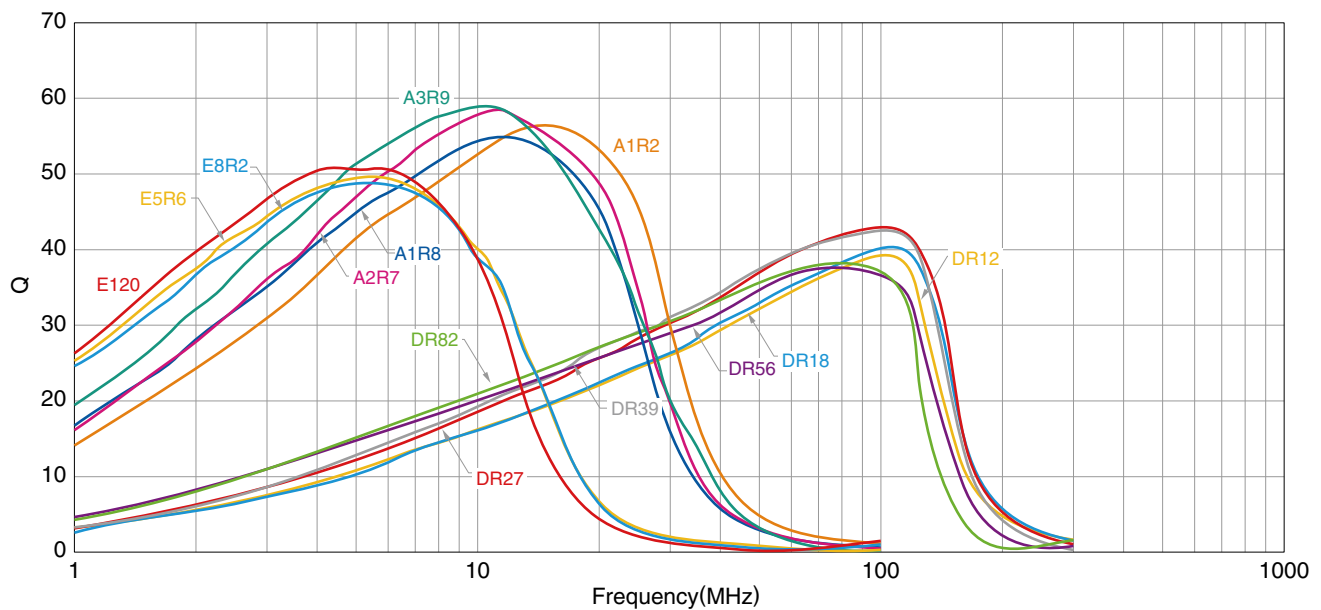
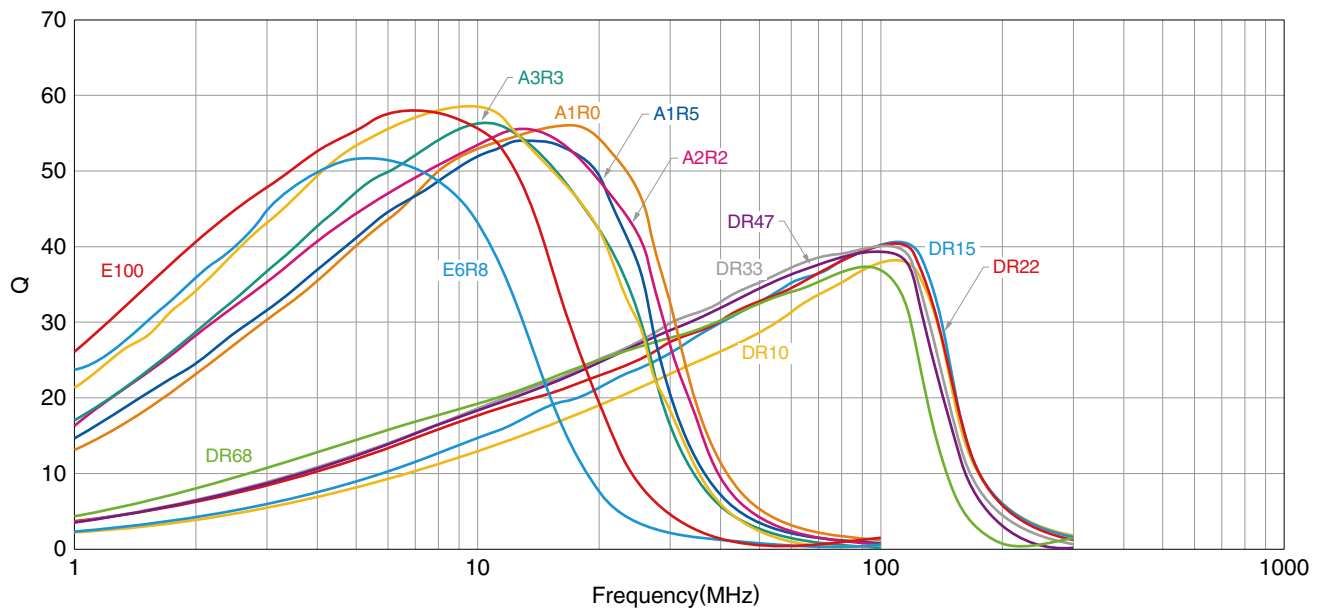

Measurement equipment

Product No.	Manufacturer
E4991A+16192A	Keysight Technologies

* Equivalent measurement equipment may be used.

MLF1608 type

Q FREQUENCY CHARACTERISTICS

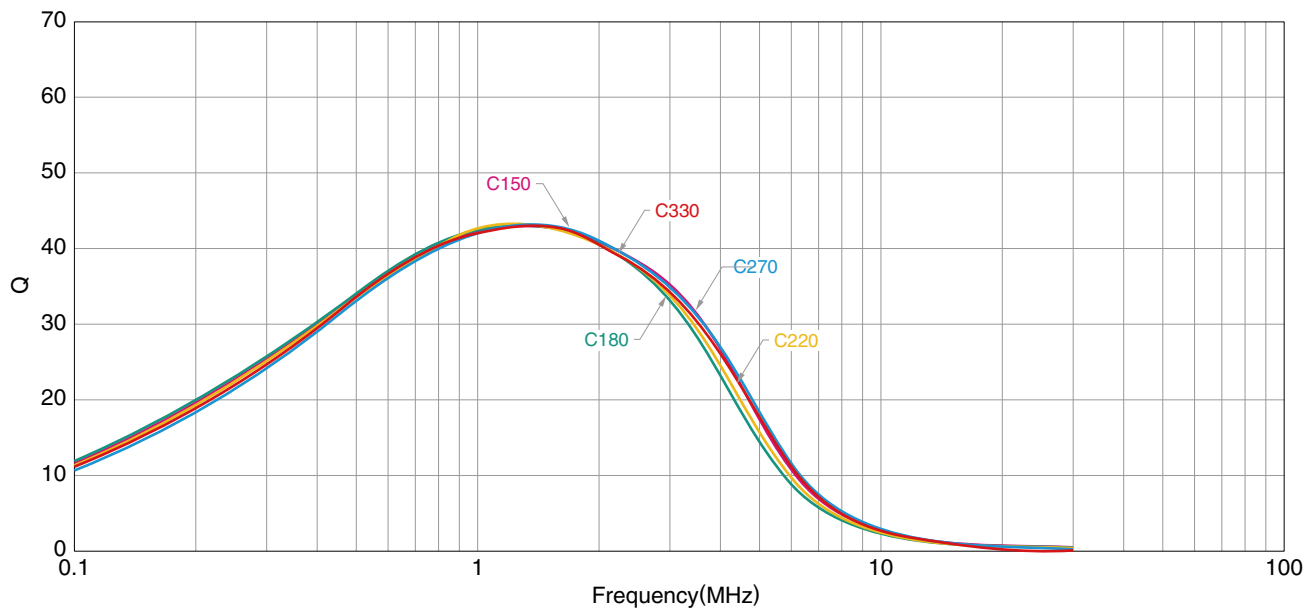

Measurement equipment

Product No.	Manufacturer
4294A+16034G	Keysight Technologies

* Equivalent measurement equipment may be used.

MLF1608 type

SHAPE & DIMENSIONS

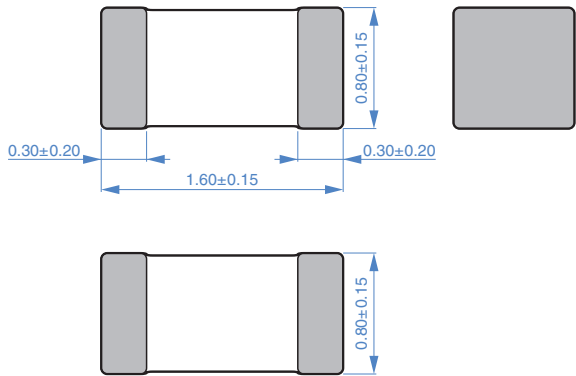

Dimensions in mm

PACKAGING STYLE

REEL DIMENSIONS

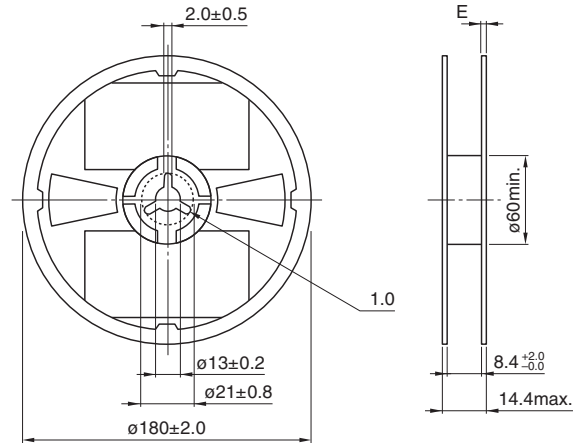

Dimensions in mm

RECOMMENDED LAND PATTERN

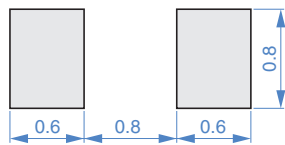

Dimensions in mm

TAPE DIMENSIONS

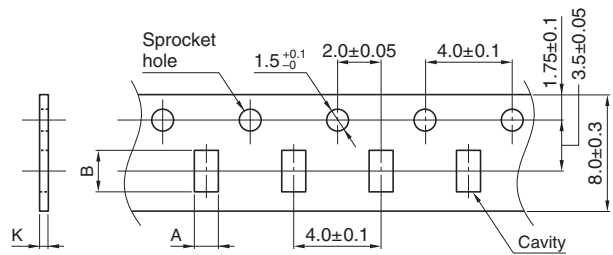

Dimensions in mm

Type	A	B	K
MLF1608	1.1±0.2	1.9±0.2	1.1 max.

RECOMMENDED REFLOW PROFILE

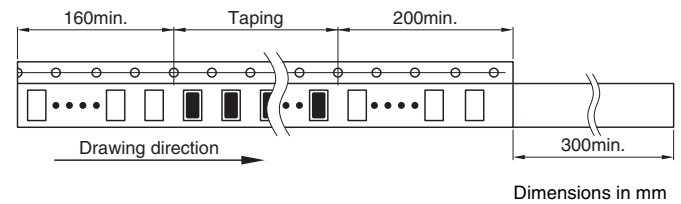
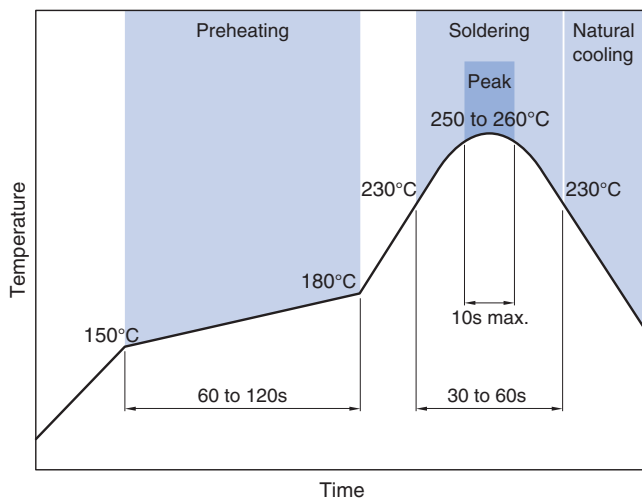

Dimensions in mm

PACKAGE QUANTITY

Package quantity	4000 pcs/reel
------------------	---------------

TEMPERATURE RANGE, INDIVIDUAL WEIGHT

Operating temperature range*	Storage temperature range**	Individual weight
-55 to +125 °C	-55 to +125 °C	4 mg

* In case the product's inductance is 15µH or higher, both operating and storage temperature ranges are -40 to +85°C.

** The storage temperature range is for after the assembly.

REMINDERS FOR USING THESE PRODUCTS

Before using these products, be sure to request the delivery specifications.

SAFETY REMINDERS

Please pay sufficient attention to the warnings for safe designing when using this products.

REMINDERS

- The storage period is less than 12 months. Be sure to follow the storage conditions (temperature: 5 to 40°C, humidity: 10 to 75% RH or less).
If the storage period elapses, the soldering of the terminal electrodes may deteriorate.
- Do not use or store in locations where there are conditions such as gas corrosion (salt, acid, alkali, etc.).
- Before soldering, be sure to preheat components.
The preheating temperature should be set so that the temperature difference between the solder temperature and chip temperature does not exceed 150°C.
- Soldering corrections after mounting should be within the range of the conditions determined in the specifications.
If overheated, a short circuit, performance deterioration, or lifespan shortening may occur.
- When embedding a printed circuit board where a chip is mounted to a set, be sure that residual stress is not given to the chip due to the overall distortion of the printed circuit board and partial distortion such as at screw tightening portions.
- Self heating (temperature increase) occurs when the power is turned ON, so the tolerance should be sufficient for the set thermal design.
- Carefully lay out the coil for the circuit board design of the non-magnetic shield type.
A malfunction may occur due to magnetic interference.
- Use a wrist band to discharge static electricity in your body through the grounding wire.
- Do not expose the products to magnets or magnetic fields.
- Do not use for a purpose outside of the contents regulated in the delivery specifications.
- The products listed on this catalog are intended for use in general electronic equipment (AV equipment, telecommunications equipment, home appliances, amusement equipment, computer equipment, personal equipment, office equipment, measurement equipment, industrial robots) under a normal operation and use condition.
The products are not designed or warranted to meet the requirements of the applications listed below, whose performance and/or quality require a more stringent level of safety or reliability, or whose failure, malfunction or trouble could cause serious damage to society, person or property.
If you intend to use the products in the applications listed below or if you have special requirements exceeding the range or conditions set forth in the each catalog, please contact us.

- (1) Aerospace/aviation equipment
- (2) Transportation equipment (cars, electric trains, ships, etc.)
- (3) Medical equipment
- (4) Power-generation control equipment
- (5) Atomic energy-related equipment
- (6) Seabed equipment
- (7) Transportation control equipment

- (8) Public information-processing equipment
- (9) Military equipment
- (10) Electric heating apparatus, burning equipment
- (11) Disaster prevention/crime prevention equipment
- (12) Safety equipment
- (13) Other applications that are not considered general-purpose applications

When designing your equipment even for general-purpose applications, you are kindly requested to take into consideration securing protection circuit/device or providing backup circuits in your equipment.

OUR CERTIFICATE

DiGi provide top-quality products and perfect service for customer worldwide through standardization, technological innovation and continuous improvement. DiGi through third-party certification, we stricly control the quality of products and services. Welcome your RFQ to

Email: Info@DiGi-Electronics.com



Tel: +00 852-30501935

RFQ Email: Info@DiGi-Electronics.com

DiGi is a global authorized distributor of electronic components.