

MMZ2012D121BTD25 Datasheet

www.digi-electronics.com

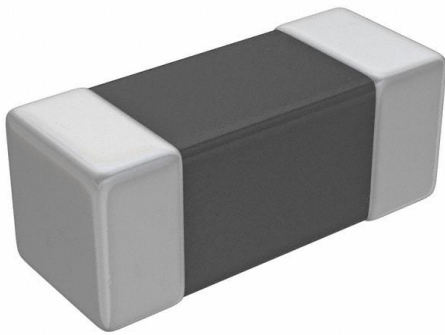

<https://www.DiGi-Electronics.com>

DiGi Electronics Part Number	MMZ2012D121BTD25-DG
Manufacturer	TDK Corporation
Manufacturer Product Number	MMZ2012D121BTD25
Description	FERRITE BEAD 120 OHM 0805 1LN
Detailed Description	120 Ohms @ 100 MHz 1 Signal Line Ferrite Bead 0805 (2012 Metric) 500mA 300mOhm

This model MMZ2012D121BTD25 is available at DiGi Electronics.

DiGi Electronics offers a global database of semiconductor and electronic component datasheets.

We welcome your inquiries regarding pricing, lead time, or other product-related questions.

 [Request a Quote](#)

 [Datasheet Search](#)



Tel: +00 852-30501935

RFQ Email: Info@DiGi-Electronics.com

DiGi is a global authorized distributor of electronic components.

Purchase and inquiry

Manufacturer Product Number:

MMZ2012D121BTD25

Series:

MMZ

Filter Type:

Signal Line

Impedance @ Frequency:

120 Ohms @ 100 MHz

DC Resistance (DCR) (Max):

300mOhm

Operating Temperature:

-55°C ~ 125°C

Mounting Type:

Surface Mount

Size / Dimension:

0.079" L x 0.049" W (2.00mm x 1.25mm)

Manufacturer:

TDK Corporation

Product Status:

Last Time Buy

Number of Lines:

1

Current Rating (Max):

500mA

Ratings:

AEC-Q200

Package / Case:

0805 (2012 Metric)

Height (Max):

0.041" (1.05mm)

Environmental & Export classification

RoHS Status:

ROHS3 Compliant

REACH Status:

REACH Unaffected

HTSUS:

8548.00.0000

Moisture Sensitivity Level (MSL):

1 (Unlimited)

ECCN:

EAR99

Chip beads

For general signal line

MMZ series (for automotive)



AEC-Q200

MMZ2012 type



FEATURES

- Noise reduction solution for general signal line.
- Various frequency characteristics with 4 materials of different features for countermeasures against everything from general signals to high-speed signals.
- Operating temperature range: -55 to +125°C

APPLICATION

- Various ECUs, powertrains, body controls, and car multimedia (telematics).

PART NUMBER CONSTRUCTION

MMZ	2012	R	150	A	T	D25
Series name	LxWxT dimensions 2.0x1.25x0.85 mm	Material name	Impedance (Ω) at 100MHz	Characteristic type	Packaging style	Internal code

CHARACTERISTICS SPECIFICATION TABLE

Impedance [100MHz] (Ω)	Tolerance	DC resistance (Ω)max.	Rated current (mA)max.	Part No.
15	$\pm 25\%$	0.05	1500	MMZ2012R150ATD25
30	$\pm 25\%$	0.05	1500	MMZ2012R300ATD25
60	$\pm 25\%$	0.10	1000	MMZ2012R600ATD25
120	$\pm 25\%$	0.12	800	MMZ2012R121ATD25
300	$\pm 25\%$	0.15	600	MMZ2012R301ATD25
600	$\pm 25\%$	0.20	500	MMZ2012R601ATD25
1000	$\pm 25\%$	0.30	500	MMZ2012R102ATD25
40	$\pm 25\%$	0.10	1000	MMZ2012S400ATD25
80	$\pm 25\%$	0.10	800	MMZ2012S800ATD25
120	$\pm 25\%$	0.15	800	MMZ2012S121ATD25
150	$\pm 25\%$	0.15	700	MMZ2012S151ATD25
180	$\pm 25\%$	0.15	600	MMZ2012S181ATD25
300	$\pm 25\%$	0.20	600	MMZ2012S301ATD25
600	$\pm 25\%$	0.30	500	MMZ2012S601ATD25
1000	$\pm 25\%$	0.35	500	MMZ2012S102ATD25

Measurement equipment

Measurement item	Product No.	Manufacturer
Impedance	E4991A+16192A	Keysight Technologies
DC resistance	Type-7556	Yokogawa

* Equivalent measurement equipment may be used.

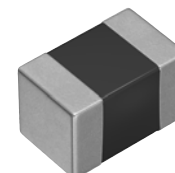

MMZ2012 type

CHARACTERISTICS SPECIFICATION TABLE

Impedance [100MHz] (Ω)		DC resistance (Ω)max.	Rated current (mA)max.	Part No.
	Tolerance			
15	±25%	0.05	1500	MMZ2012Y150BTD25
30	±25%	0.05	1500	MMZ2012Y300BTD25
60	±25%	0.10	1000	MMZ2012Y600BTD25
120	±25%	0.12	800	MMZ2012Y121BTD25
300	±25%	0.15	600	MMZ2012Y301BTD25
600	±25%	0.20	500	MMZ2012Y601BTD25
1000	±25%	0.30	500	MMZ2012Y102BTD25
1500	±25%	0.40	500	MMZ2012Y152BTD25
2000	±25%	0.50	400	MMZ2012Y202BTD25
80	±25%	0.30	500	MMZ2012D800BTD25
120	±25%	0.30	500	MMZ2012D121BTD25
300	±25%	0.50	400	MMZ2012D301BTD25

Measurement equipment

Measurement item	Product No.	Manufacturer
Impedance	E4991A+16192A	Keysight Technologies
DC resistance	Type-7556	Yokogawa

* Equivalent measurement equipment may be used.

MMZ2012 type

Z VS. FREQUENCY CHARACTERISTICS (BY SERIES)

MMZ2012R series

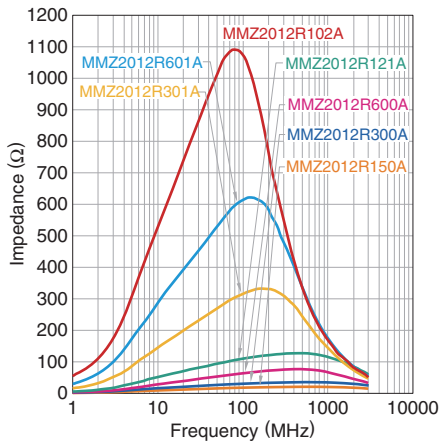

MMZ2012S series

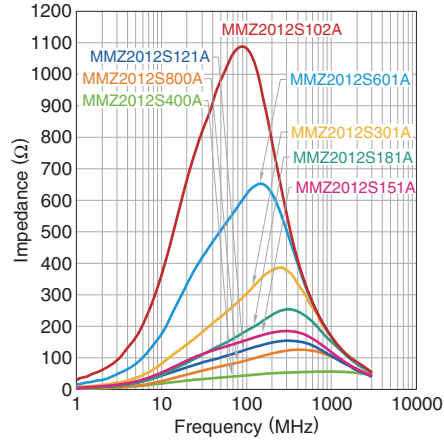

MMZ2012Y series

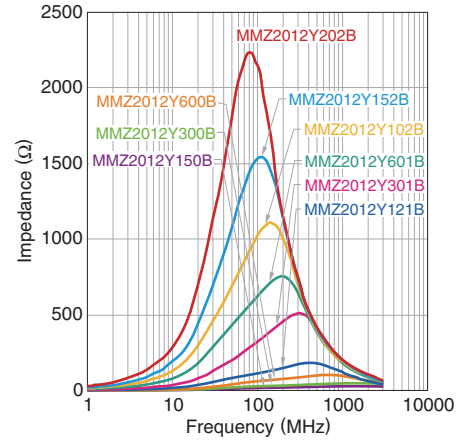

MMZ2012D series

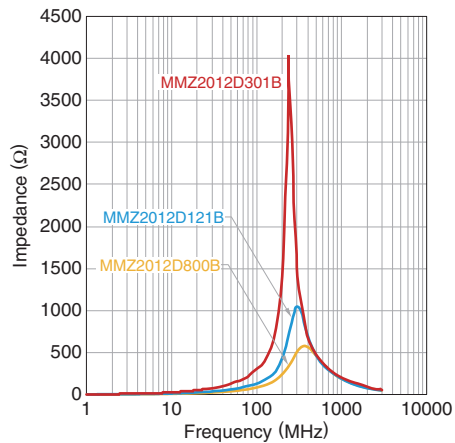

MMZ2012 type

Z, X, R VS. FREQUENCY CHARACTERISTICS

MMZ2012R150ATD25

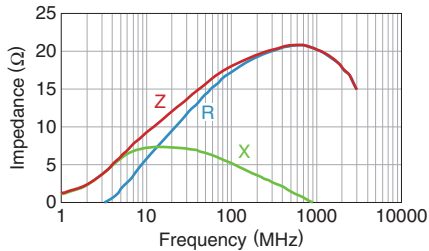

MMZ2012R300ATD25

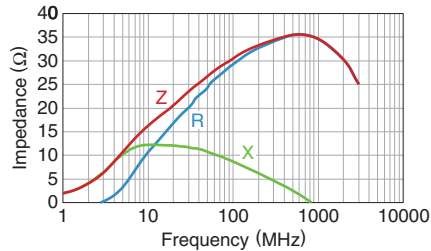

MMZ2012R600ATD25

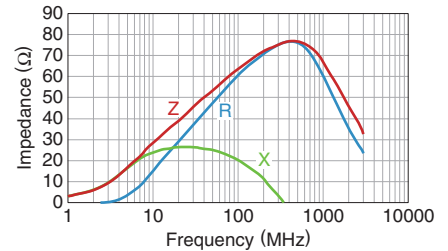

MMZ2012R121ATD25

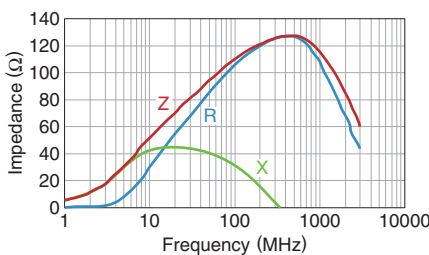

MMZ2012R301ATD25

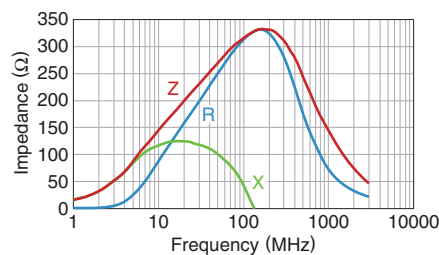

MMZ2012R601ATD25

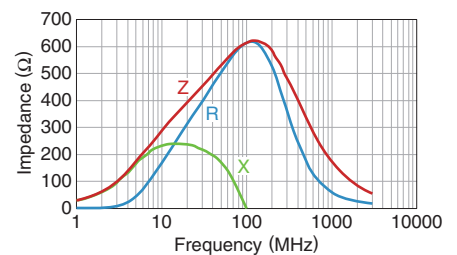

MMZ2012R102ATD25

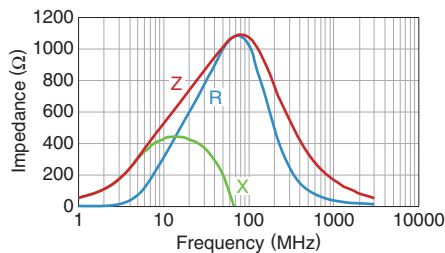

MMZ2012S400ATD25

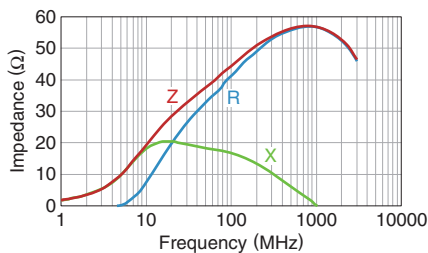

MMZ2012S800ATD25

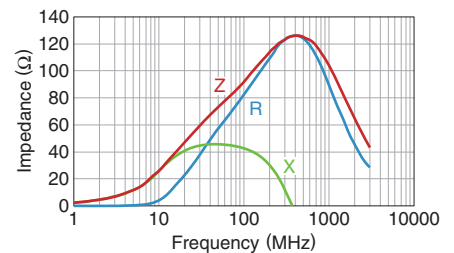

MMZ2012S121ATD25

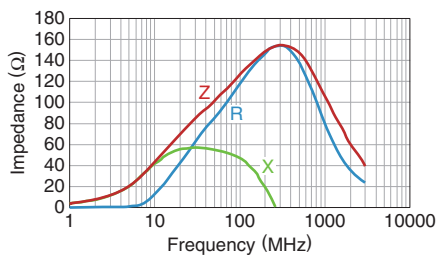

MMZ2012S151ATD25

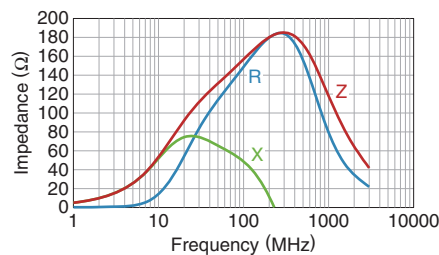

MMZ2012S181ATD25

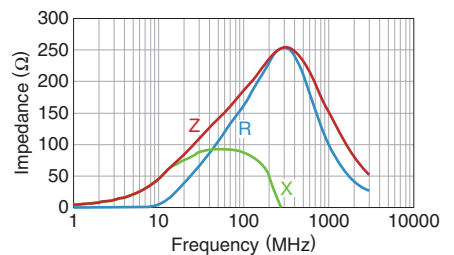

MMZ2012S301ATD25

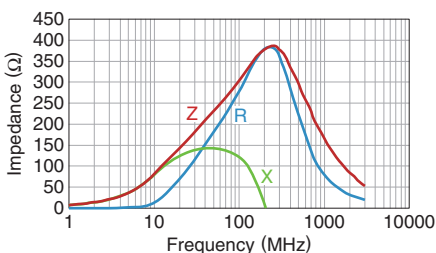

MMZ2012S601ATD25

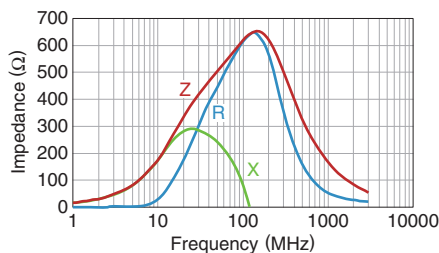

MMZ2012S102ATD25

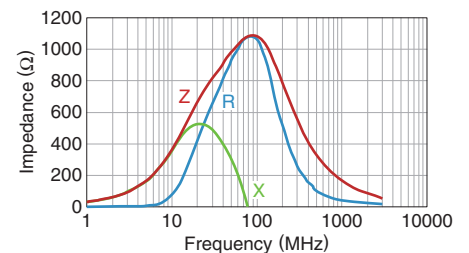

MMZ2012 type

Z, X, R VS. FREQUENCY CHARACTERISTICS

MMZ2012Y150BTD25

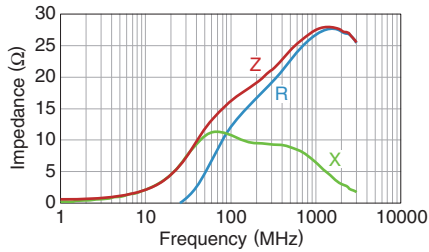

MMZ2012Y300BTD25

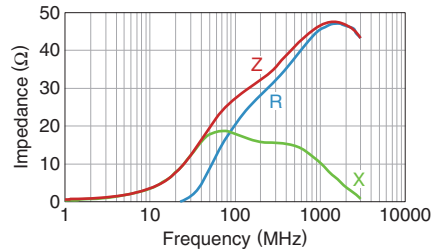

MMZ2012Y600BTD25

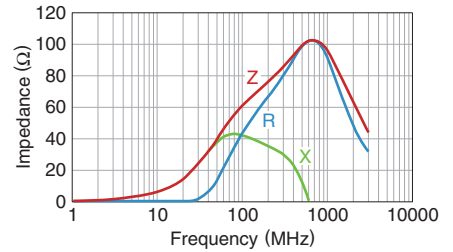

MMZ2012Y121BTD25

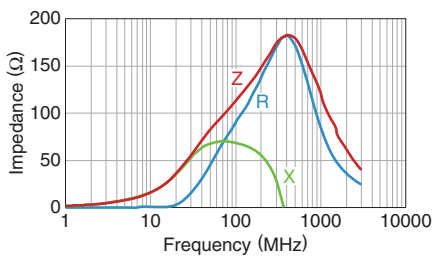

MMZ2012Y301BTD25

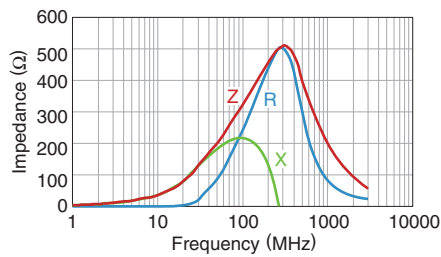

MMZ2012Y601BTD25

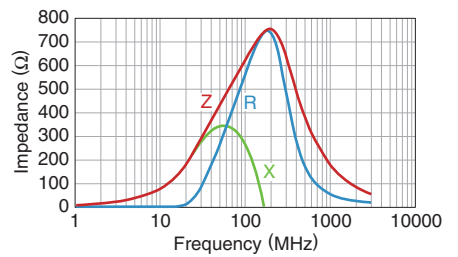

MMZ2012Y102BTD25

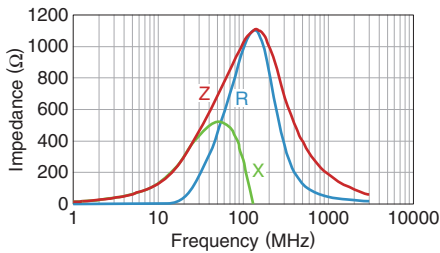

MMZ2012Y152BTD25

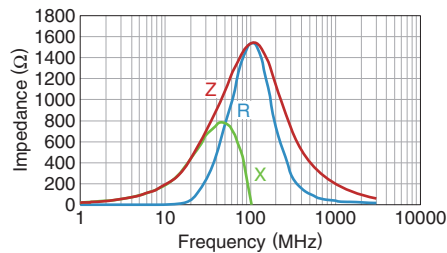

MMZ2012Y202BTD25

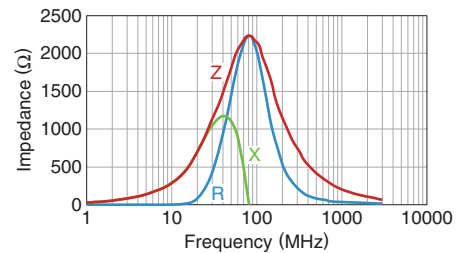

MMZ2012D800BTD25

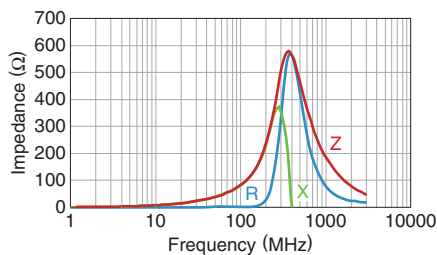

MMZ2012D121BTD25

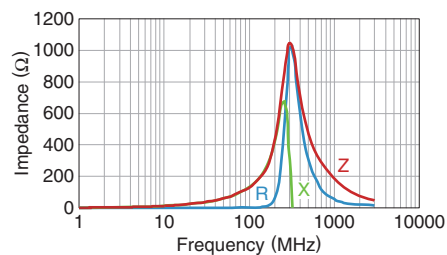

MMZ2012D301BTD25

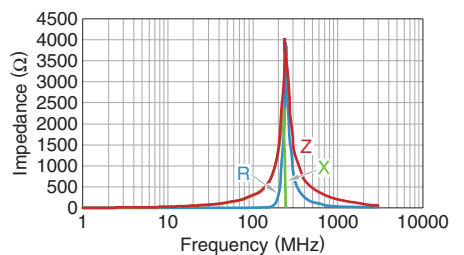

MMZ2012 type

SHAPE & DIMENSIONS

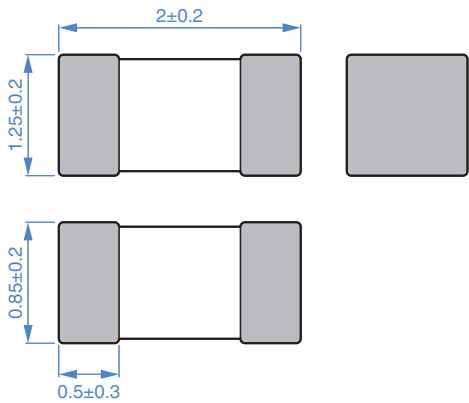

Dimensions in mm

PACKAGING STYLE

REEL DIMENSIONS

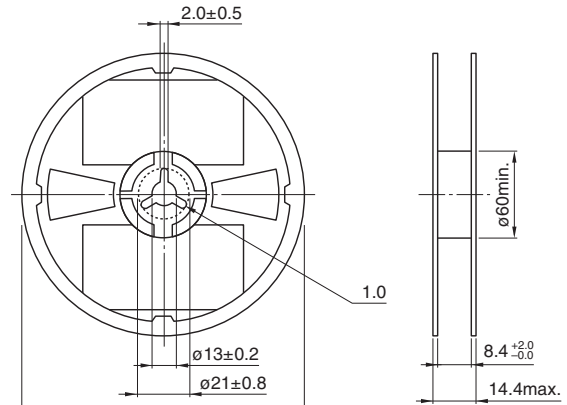

Dimensions in mm

RECOMMENDED LAND PATTERN

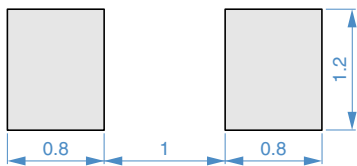

Dimensions in mm

TAPE DIMENSIONS

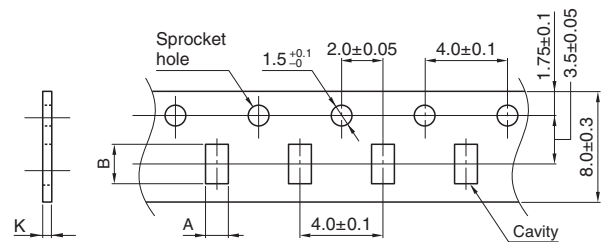

Dimensions in mm

RECOMMENDED REFLOW PROFILE

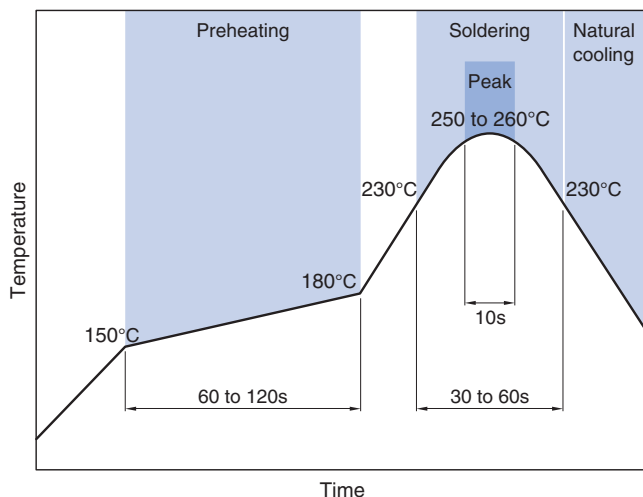

Type	A	B	K
MMZ2012	1.5±0.2	2.3±0.2	1.1max.

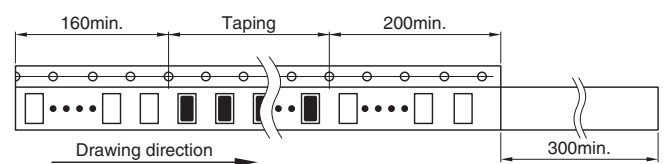

Dimensions in mm

PACKAGE QUANTITY

Package quantity	4,000 pcs/reel
------------------	----------------

TEMPERATURE RANGE, INDIVIDUAL WEIGHT

Operating temperature range	Storage temperature range*	Individual weight
-55 to +125°C	-55 to +125°C	8 mg

* The storage temperature range is for after the assembly.

REMINDERS FOR USING THESE PRODUCTS

Before using these products, be sure to request the delivery specifications.

SAFETY REMINDERS

Please pay sufficient attention to the warnings for safe designing when using this products.

REMINDERS

- The storage period is within 12 months. Be sure to follow the storage conditions (temperature: 5 to 40°C, humidity: 10 to 75% RH or less).
If the storage period elapses, the soldering of the terminal electrodes may deteriorate.
- Do not use or store in locations where there are conditions such as gas corrosion (salt, acid, alkali, etc.).
- Before soldering, be sure to preheat components.
The preheating temperature should be set so that the temperature difference between the solder temperature and chip temperature does not exceed 150°C.
- Soldering corrections after mounting should be within the range of the conditions determined in the specifications.
If overheated, a short circuit, performance deterioration, or lifespan shortening may occur.
- When embedding a printed circuit board where a chip is mounted to a set, be sure that residual stress is not given to the chip due to the overall distortion of the printed circuit board and partial distortion such as at screw tightening portions.
- Self heating (temperature increase) occurs when the power is turned ON, so the tolerance should be sufficient for the set thermal design.
- Carefully lay out the coil for the circuit board design of the non-magnetic shield type.
A malfunction may occur due to magnetic interference.
- Use a wrist band to discharge static electricity in your body through the grounding wire.
- Do not expose the products to magnets or magnetic fields.
- Do not use for a purpose outside of the contents regulated in the delivery specifications.
- The products listed on this catalog are intended for use in general electronic equipment (AV equipment, telecommunications equipment, home appliances, amusement equipment, computer equipment, personal equipment, office equipment, measurement equipment, industrial robots) under a normal operation and use condition.
The products are not designed or warranted to meet the requirements of the applications listed below, whose performance and/or quality require a more stringent level of safety or reliability, or whose failure, malfunction or trouble could cause serious damage to society, person or property.
If you intend to use the products in the applications listed below or if you have special requirements exceeding the range or conditions set forth in the each catalog, please contact us.

- (1) Aerospace/aviation equipment
- (2) Transportation equipment (electric trains, ships, etc.)
- (3) Medical equipment
- (4) Power-generation control equipment
- (5) Atomic energy-related equipment
- (6) Seabed equipment
- (7) Transportation control equipment

- (8) Public information-processing equipment
- (9) Military equipment
- (10) Electric heating apparatus, burning equipment
- (11) Disaster prevention/crime prevention equipment
- (12) Safety equipment
- (13) Other applications that are not considered general-purpose applications

When designing your equipment even for general-purpose applications, you are kindly requested to take into consideration securing protection circuit/device or providing backup circuits in your equipment.

OUR CERTIFICATE

DiGi provide top-quality products and perfect service for customer worldwide through standardization, technological innovation and continuous improvement. DiGi through third-party certification, we stricly control the quality of products and services. Welcome your RFQ to

Email: Info@DiGi-Electronics.com



Tel: +00 852-30501935

RFQ Email: Info@DiGi-Electronics.com

DiGi is a global authorized distributor of electronic components.