

# NLV25T-150J-EF Datasheet

[www.digi-electronics.com](http://www.digi-electronics.com)



<https://www.DiGi-Electronics.com>

DiGi Electronics Part Number	NLV25T-150J-EF-DG
Manufacturer	<a href="#">TDK Corporation</a>
Manufacturer Product Number	NLV25T-150J-EF
Description	FIXED IND 15UH 140MA 4.4 OHM SMD
Detailed Description	15 $\mu$ H Unshielded Drum Core, Wirewound Inductor 140 mA 4.4Ohm Max 1008 (2520 Metric)



Tel: +00 852-30501935

RFQ Email: [Info@DiGi-Electronics.com](mailto:Info@DiGi-Electronics.com)

DiGi is a global authorized distributor of electronic components.



## Purchase and inquiry

### Manufacturer Product Number:

NLV25T-150J-EF

### Series:

NLV-EF

### Type:

Drum Core, Wirewound

### Inductance:

15  $\mu$ H

### Current Rating (Amps):

140 mA

### Shielding:

Unshielded

### Q @ Freq:

25 @ 2.52MHz

### Ratings:

-

### Inductance Frequency - Test:

2.52 MHz

### Package / Case:

1008 (2520 Metric)

### Size / Dimension:

0.098" L x 0.079" W (2.50mm x 2.00mm)

### Manufacturer:

TDK Corporation

### Product Status:

Active

### Material - Core:

Ferrite

### Tolerance:

$\pm$ 5%

### Current - Saturation (Isat):

-

### DC Resistance (DCR):

4.40hm Max

### Frequency - Self Resonant:

26MHz

### Operating Temperature:

-40°C ~ 105°C

### Mounting Type:

Surface Mount

### Supplier Device Package:

1008 (2520 Metric)

### Height - Seated (Max):

0.075" (1.90mm)

## Environmental & Export classification

### RoHS Status:

ROHS3 Compliant

### REACH Status:

REACH Affected

### HTSUS:

8504.50.8000

### Moisture Sensitivity Level (MSL):

1 (Unlimited)

### ECCN:

EAR99

## Inductors for standard circuits

## Wound ferrite

## NLV-EF series



## NLV25-EF type



## FEATURES

- Resin mold type wound inductor for standard circuits.
- E-12 series, wide lineup compatible with J ( $\pm 5\%$ ) tolerance, can be used for applications that need to meet strict L tolerance such as filter circuits.
- Has excellent inductance temperature characteristics in the operating temperature range.
- Operating temperature range:  $-40$  to  $+105^{\circ}\text{C}$  (including self-temperature rise)

## APPLICATION

- Smart meters, AV equipment, xDSL, electronic devices for communications infrastructure such as mobile base stations, industrial equipment, other

## PART NUMBER CONSTRUCTION

NLV	25	T	-	010	-	J	-	EF
Series name	LxWxH dimensions 2.5x2.0x1.8 mm	Packaging style		Inductance ( $\mu\text{H}$ )		Inductance tolerance		Internal code

## CHARACTERISTICS SPECIFICATION TABLE

L	Q	L, Q measuring frequency	Self-resonant frequency	DC resistance	Rated current	Part No.
( $\mu\text{H}$ )	Tolerance	min. (MHz)	(MHz)min.	( $\Omega$ )max.	(mA)max.	
0.01	$\pm 5\%$	15	100	2150	530	<a href="#">NLV25T-010J-EF</a>
0.012	$\pm 5\%$	15	100	2050	500	<a href="#">NLV25T-012J-EF</a>
0.015	$\pm 5\%$	15	100	2000	480	<a href="#">NLV25T-015J-EF</a>
0.018	$\pm 5\%$	15	100	1850	450	<a href="#">NLV25T-018J-EF</a>
0.022	$\pm 5\%$	15	100	1650	420	<a href="#">NLV25T-022J-EF</a>
0.027	$\pm 5\%$	15	100	1550	410	<a href="#">NLV25T-027J-EF</a>
0.033	$\pm 5\%$	20	100	1450	400	<a href="#">NLV25T-033J-EF</a>
0.039	$\pm 5\%$	20	100	1350	380	<a href="#">NLV25T-039J-EF</a>
0.047	$\pm 5\%$	20	100	1200	360	<a href="#">NLV25T-047J-EF</a>
0.056	$\pm 5\%$	20	100	1100	340	<a href="#">NLV25T-056J-EF</a>
0.068	$\pm 5\%$	20	100	1050	320	<a href="#">NLV25T-068J-EF</a>
0.082	$\pm 5\%$	20	100	900	300	<a href="#">NLV25T-082J-EF</a>
0.1	$\pm 5\%$	20	100	800	280	<a href="#">NLV25T-R10J-EF</a>

## Measurement equipment

Measurement item	Product No.	Manufacturer
L, Q	4294A+16197A 4294A+16093B	Keysight Technologies
Self-resonant frequency	E5063A	Keysight Technologies
DC resistance	AX-114N	ADEX

\* Equivalent measurement equipment may be used.

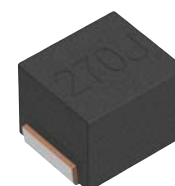

# NLV25-EF type

## CHARACTERISTICS SPECIFICATION TABLE

L	Q	L, Q measuring frequency	Self-resonant frequency	DC resistance	Rated current	Part No.	
( $\mu$ H)	Tolerance	min.	(MHz)min.	( $\Omega$ )max.	(mA)max.		
0.12	$\pm 5\%$	30	25.2	700	0.3	550	<a href="#">NLV25T-R12J-EF</a>
0.15	$\pm 5\%$	30	25.2	550	0.35	500	<a href="#">NLV25T-R15J-EF</a>
0.18	$\pm 5\%$	30	25.2	500	0.4	475	<a href="#">NLV25T-R18J-EF</a>
0.22	$\pm 5\%$	30	25.2	450	0.5	450	<a href="#">NLV25T-R22J-EF</a>
0.27	$\pm 5\%$	30	25.2	425	0.55	425	<a href="#">NLV25T-R27J-EF</a>
0.33	$\pm 5\%$	30	25.2	400	0.6	400	<a href="#">NLV25T-R33J-EF</a>
0.39	$\pm 5\%$	30	25.2	375	0.65	375	<a href="#">NLV25T-R39J-EF</a>
0.47	$\pm 5\%$	30	25.2	350	0.68	350	<a href="#">NLV25T-R47J-EF</a>
0.56	$\pm 5\%$	30	25.2	325	0.75	325	<a href="#">NLV25T-R56J-EF</a>
0.68	$\pm 5\%$	30	25.2	300	0.85	300	<a href="#">NLV25T-R68J-EF</a>
0.82	$\pm 5\%$	30	25.2	260	1	260	<a href="#">NLV25T-R82J-EF</a>
1	$\pm 5\%$	30	7.96	245	1.1	245	<a href="#">NLV25T-1R0J-EF</a>
1.2	$\pm 5\%$	30	7.96	230	1.2	230	<a href="#">NLV25T-1R2J-EF</a>
1.5	$\pm 5\%$	30	7.96	182	1.3	220	<a href="#">NLV25T-1R5J-EF</a>
1.8	$\pm 5\%$	30	7.96	135	1.45	210	<a href="#">NLV25T-1R8J-EF</a>
2.2	$\pm 5\%$	30	7.96	105	1.55	200	<a href="#">NLV25T-2R2J-EF</a>
2.7	$\pm 5\%$	30	7.96	70	1.7	195	<a href="#">NLV25T-2R7J-EF</a>
3.3	$\pm 5\%$	30	7.96	55	1.9	185	<a href="#">NLV25T-3R3J-EF</a>
3.9	$\pm 5\%$	30	7.96	48	2.1	180	<a href="#">NLV25T-3R9J-EF</a>
4.7	$\pm 5\%$	30	7.96	43	2.3	175	<a href="#">NLV25T-4R7J-EF</a>
5.6	$\pm 5\%$	25	7.96	42	2.5	170	<a href="#">NLV25T-5R6J-EF</a>
6.8	$\pm 5\%$	25	7.96	39	2.7	165	<a href="#">NLV25T-6R8J-EF</a>
8.2	$\pm 5\%$	25	7.96	36	3.05	160	<a href="#">NLV25T-8R2J-EF</a>
10	$\pm 5\%$	25	2.52	33	3.5	155	<a href="#">NLV25T-100J-EF</a>
12	$\pm 5\%$	25	2.52	30	3.8	150	<a href="#">NLV25T-120J-EF</a>
15	$\pm 5\%$	25	2.52	26	4.4	140	<a href="#">NLV25T-150J-EF</a>
18	$\pm 5\%$	25	2.52	24	4.8	130	<a href="#">NLV25T-180J-EF</a>
22	$\pm 5\%$	25	2.52	22	5.5	125	<a href="#">NLV25T-220J-EF</a>
27	$\pm 5\%$	25	2.52	21	6.3	115	<a href="#">NLV25T-270J-EF</a>
33	$\pm 5\%$	25	2.52	20	7.1	110	<a href="#">NLV25T-330J-EF</a>
39	$\pm 5\%$	20	2.52	18	9.5	90	<a href="#">NLV25T-390J-EF</a>
47	$\pm 5\%$	20	2.52	17	11.1	80	<a href="#">NLV25T-470J-EF</a>
56	$\pm 5\%$	20	2.52	16	12.1	75	<a href="#">NLV25T-560J-EF</a>
68	$\pm 5\%$	20	2.52	15	16.6	70	<a href="#">NLV25T-680J-EF</a>
82	$\pm 5\%$	20	2.52	13	19	66	<a href="#">NLV25T-820J-EF</a>
100	$\pm 5\%$	15	0.796	12	21	60	<a href="#">NLV25T-101J-EF</a>

### Measurement equipment

Measurement item	Product No.	Manufacturer
L, Q	4294A+16197A 4294A+16093B	Keysight Technologies
Self-resonant frequency	E5063A	Keysight Technologies
DC resistance	AX-114N	ADEX

\* Equivalent measurement equipment may be used.

# NLV25-EF type

## L FREQUENCY CHARACTERISTICS

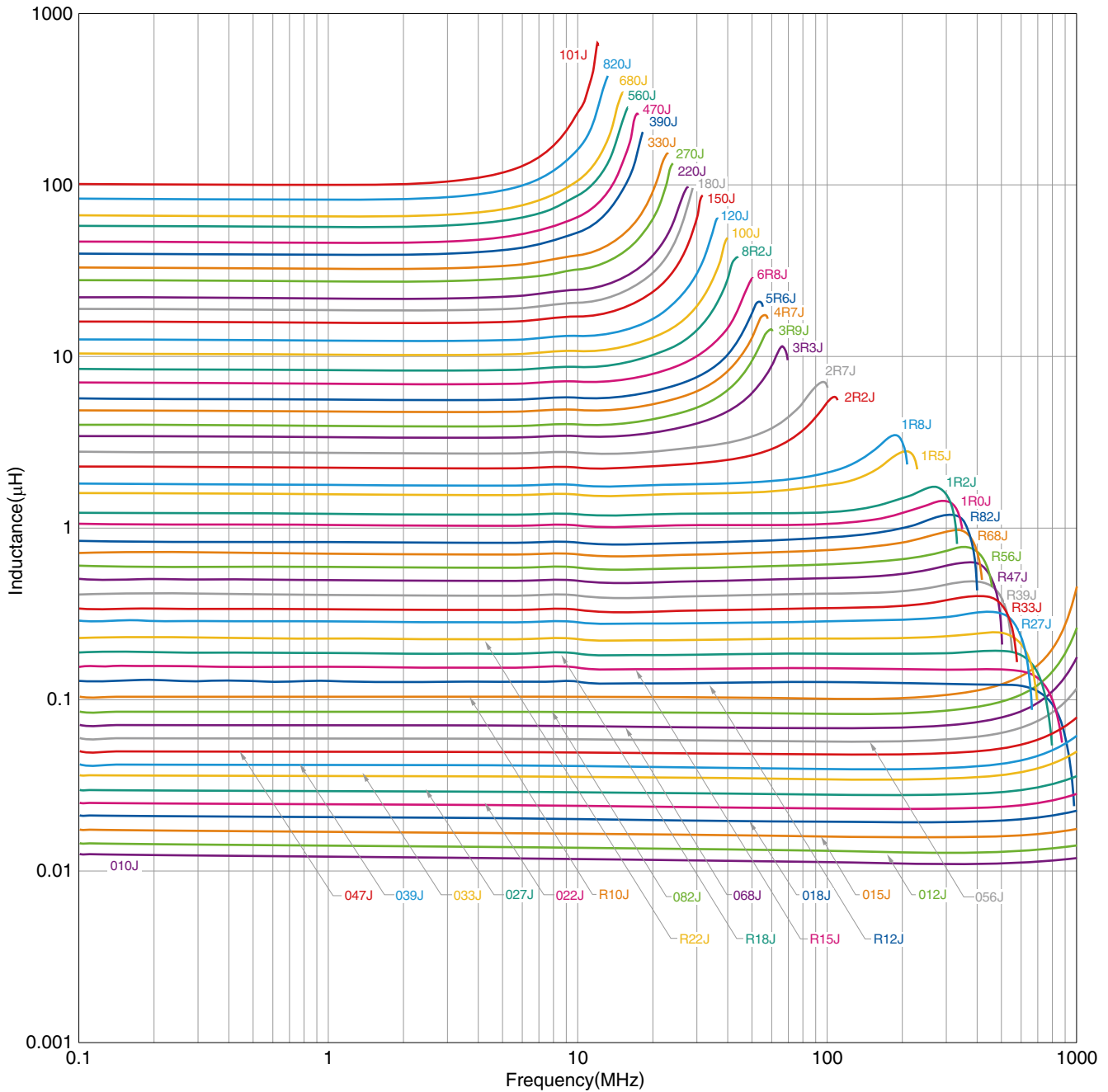

Measurement equipment

Product No.	Manufacturer
4294A	Keysight Technologies

\* Equivalent measurement equipment may be used.

# NLV25-EF type

## Q FREQUENCY CHARACTERISTICS

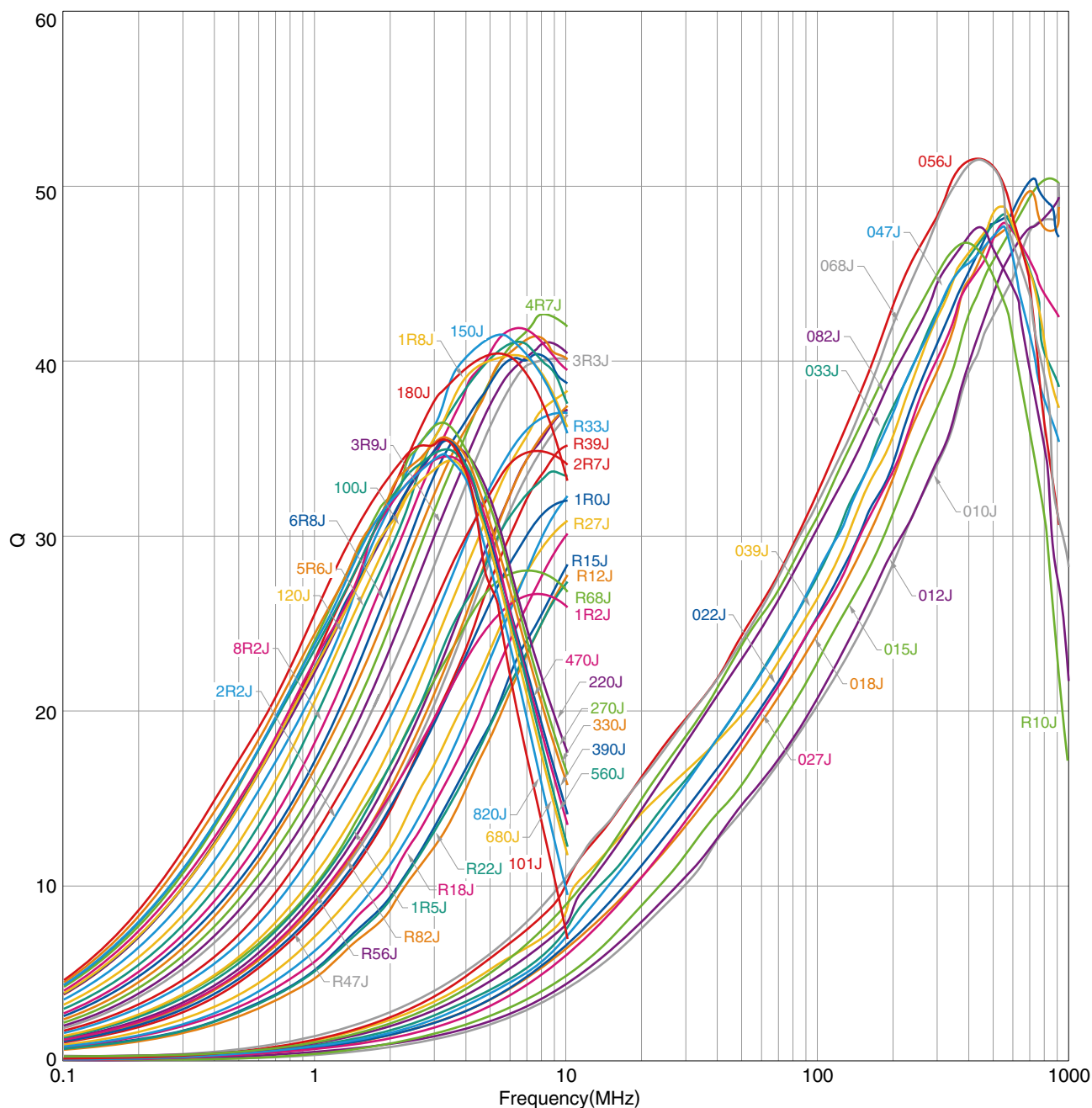

Measurement equipment

Product No.	Manufacturer
4294A	Keysight Technologies

\* Equivalent measurement equipment may be used.



# NLV25-EF type

## SHAPE & DIMENSIONS

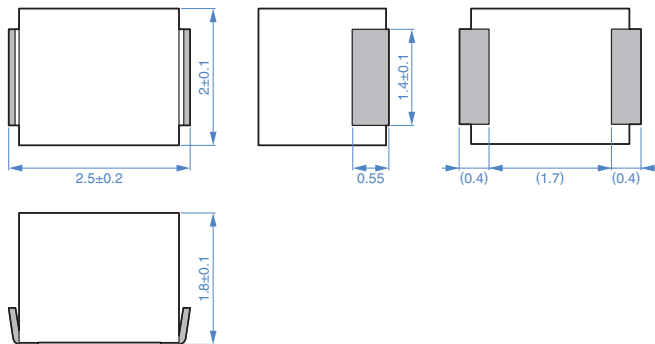

Dimensions in mm

## PACKAGING STYLE

### REEL DIMENSIONS

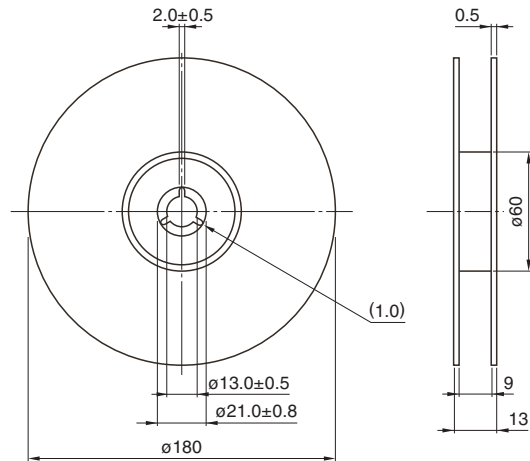

Dimensions in mm

## RECOMMENDED LAND PATTERN

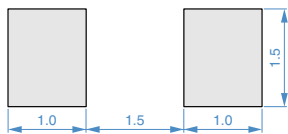

Dimensions in mm

### TAPE DIMENSIONS

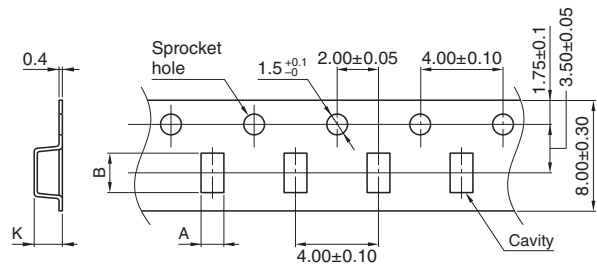

Dimensions in mm

Type	A	B	K
NLV25-EF	2.3	2.7	2

## RECOMMENDED REFLOW PROFILE

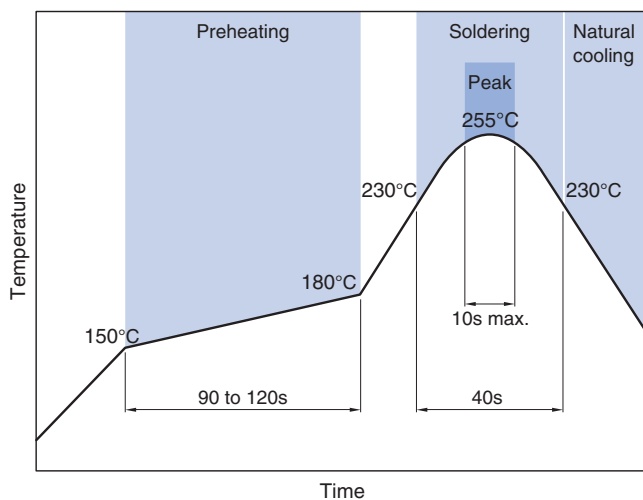

### PACKAGE QUANTITY

Package quantity	2000 pcs/reel
------------------	---------------

## TEMPERATURE RANGE, INDIVIDUAL WEIGHT

Operating temperature range*	Storage temperature range**	Individual weight
-40 to +105 °C	-40 to +105 °C	25 mg

\* Operating temperature range includes self-temperature rise.

\*\* The storage temperature range is for after the assembly.

## REMINDERS FOR USING THESE PRODUCTS

Before using these products, be sure to request the delivery specifications.

### SAFETY REMINDERS

Please pay sufficient attention to the warnings for safe designing when using this products.

#### REMINDERS

- The storage period is less than 6 months. Be sure to follow the storage conditions (temperature: 5 to 40°C, humidity: 10 to 75% RH or less).  
If the storage period elapses, the soldering of the terminal electrodes may deteriorate.
- Do not use or store in locations where there are conditions such as gas corrosion (salt, acid, alkali, etc.).
- Before soldering, be sure to preheat components.  
The preheating temperature should be set so that the temperature difference between the solder temperature and chip temperature does not exceed 150°C.
- Soldering corrections after mounting should be within the range of the conditions determined in the specifications.  
If overheated, a short circuit, performance deterioration, or lifespan shortening may occur.
- When embedding a printed circuit board where a chip is mounted to a set, be sure that residual stress is not given to the chip due to the overall distortion of the printed circuit board and partial distortion such as at screw tightening portions.
- Self heating (temperature increase) occurs when the power is turned ON, so the tolerance should be sufficient for the set thermal design.
- Carefully lay out the coil for the circuit board design of the non-magnetic shield type.  
A malfunction may occur due to magnetic interference.
- Use a wrist band to discharge static electricity in your body through the grounding wire.
- Do not expose the products to magnets or magnetic fields.
- Do not use for a purpose outside of the contents regulated in the delivery specifications.
- The products listed on this catalog are intended for use in general electronic equipment (AV equipment, telecommunications equipment, home appliances, amusement equipment, computer equipment, personal equipment, office equipment, measurement equipment, industrial robots) under a normal operation and use condition.  
The products are not designed or warranted to meet the requirements of the applications listed below, whose performance and/or quality require a more stringent level of safety or reliability, or whose failure, malfunction or trouble could cause serious damage to society, person or property.  
If you intend to use the products in the applications listed below or if you have special requirements exceeding the range or conditions set forth in the each catalog, please contact us.

- (1) Aerospace/aviation equipment
- (2) Transportation equipment (cars, electric trains, ships, etc.)
- (3) Medical equipment
- (4) Power-generation control equipment
- (5) Atomic energy-related equipment
- (6) Seabed equipment
- (7) Transportation control equipment

- (8) Public information-processing equipment
- (9) Military equipment
- (10) Electric heating apparatus, burning equipment
- (11) Disaster prevention/crime prevention equipment
- (12) Safety equipment
- (13) Other applications that are not considered general-purpose applications

When designing your equipment even for general-purpose applications, you are kindly requested to take into consideration securing protection circuit/device or providing backup circuits in your equipment.



## OUR CERTIFICATE

DiGi provide top-quality products and perfect service for customer worldwide through standardization, technological innovation and continuous improvement. DiGi through third-party certification, we stricly control the quality of products and services. Welcome your RFQ to

Email: [Info@DiGi-Electronics.com](mailto:Info@DiGi-Electronics.com)



Tel: +00 852-30501935

RFQ Email: [Info@DiGi-Electronics.com](mailto:Info@DiGi-Electronics.com)

DiGi is a global authorized distributor of electronic components.