

4-794629-2 Datasheet

www.digi-electronics.com

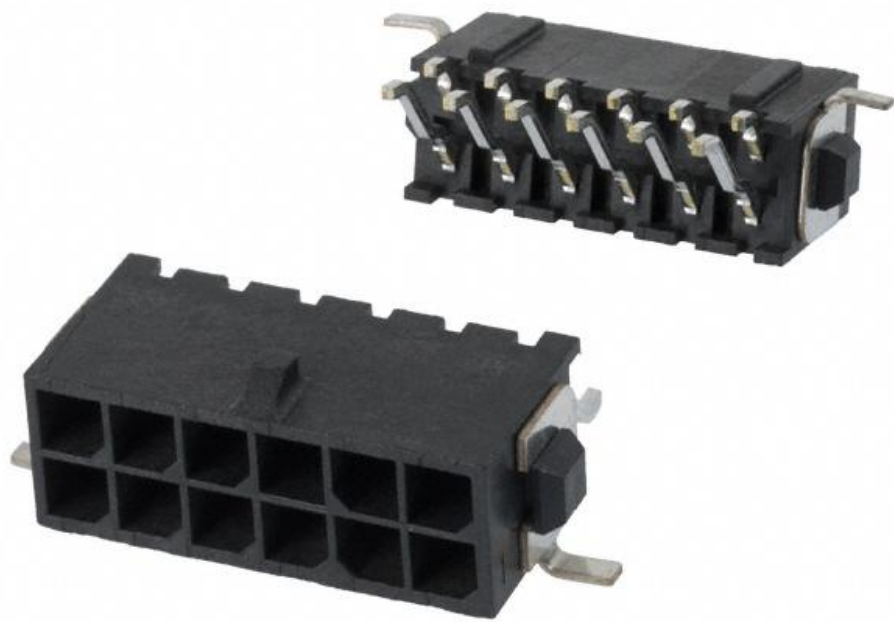

<https://www.DiGi-Electronics.com>

DiGi Electronics Part Number	4-794629-2-DG
Manufacturer	TE Connectivity AMP Connectors
Manufacturer Product Number	4-794629-2
Description	CONN HEADER SMD R/A 12POS 3MM
Detailed Description	Connector Header Surface Mount, Right Angle 12 position 0.118" (3.00mm)

This model 4-794629-2 is available at DiGi Electronics.

DiGi Electronics offers a global database of semiconductor and electronic component datasheets.

We welcome your inquiries regarding pricing, lead time, or other product-related questions.

 [Request a Quote](#)

 [Datasheet Search](#)



Tel: +00 852-30501935

RFQ Email: Info@DiGi-Electronics.com

DiGi is a global authorized distributor of electronic components.

Purchase and inquiry

Manufacturer Product Number:

4-794629-2

Series:

Micro MATE-N-LOK

Connector Type:

Header

Pitch - Mating:

0.118" (3.00mm)

Number of Rows:

2

Number of Positions Loaded:

All

Shrouding:

Shrouded - 4 Wall

Termination:

Solder

Contact Length - Mating:

-

Overall Contact Length:

-

Contact Shape:

Square

Contact Finish Thickness - Mating:

30.0µin (0.76µm)

Contact Material:

Brass

Features:

Solder Retention

Ingress Protection:

-

Insulation Color:

Black

Voltage Rating:

250V

Contact Finish Thickness - Post:

100.0µin (2.54µm)

Base Product Number:

794629

Manufacturer:

TE Connectivity AMP Connectors

Product Status:

Active

Contact Type:

Male Pin

Number of Positions:

12

Row Spacing - Mating:

0.118" (3.00mm)

Style:

Board to Cable/Wire

Mounting Type:

Surface Mount, Right Angle

Fastening Type:

Locking Ramp

Contact Length - Post:

-

Insulation Height:

0.290" (7.37mm)

Contact Finish - Mating:

Gold

Contact Finish - Post:

Tin

Insulation Material:

Polyamide (PA), Nylon

Operating Temperature:

-40°C ~ 105°C

Material Flammability Rating:

UL94 V-0

Current Rating (Amps):

Varies by Wire Gauge

Mated Stacking Heights:

-

Applications:

General Purpose

4-794629-2 ✓ ACTIVE[MATE-N-LOK](#) | [Micro MATE-N-LOK](#)

TE Internal #: 4-794629-2

PCB Mount Header, Right Angle, Wire-to-Board, 12 Position, 3 mm
 [.118 in] Centerline, Fully Shrouded, Gold (Au), Surface Mount,
 Micro MATE-N-LOK

[View on TE.com >](#)

Connectors > PCB Connectors > PCB Headers & Receptacles

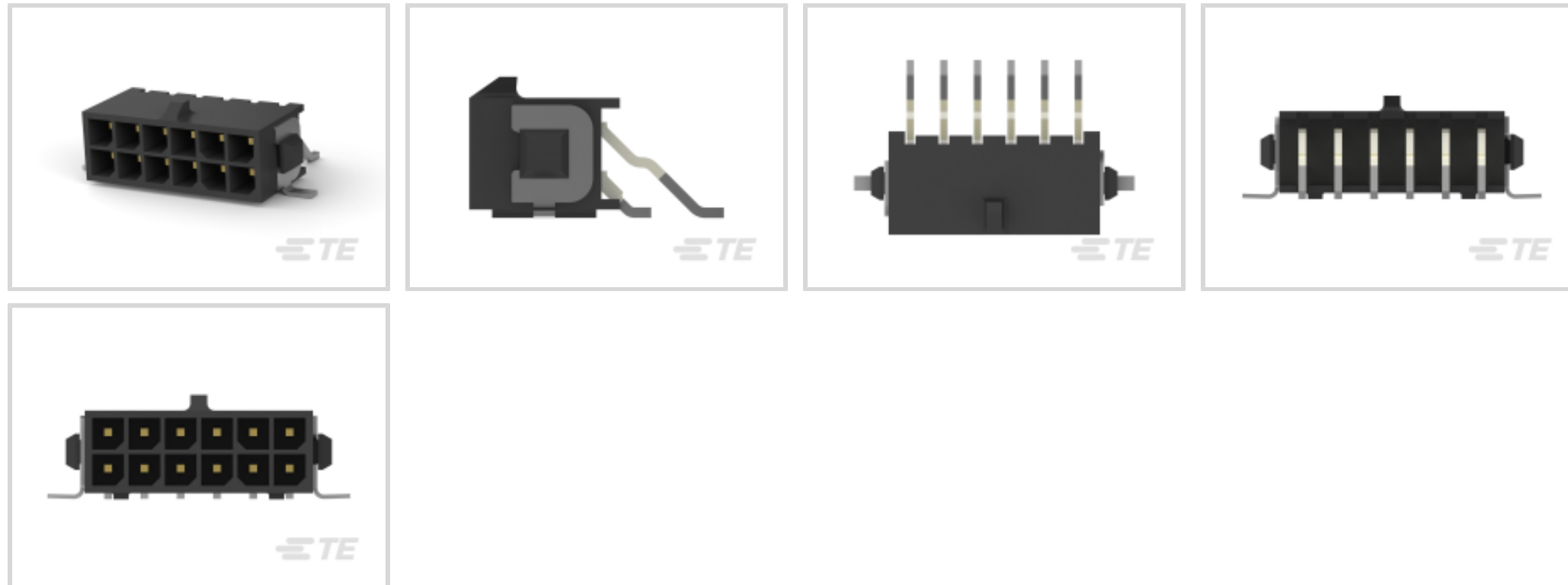
PCB Connector Type: **PCB Mount Header**PCB Mount Orientation: **Right Angle**Connector System: **Wire-to-Board**Number of Positions: **12**Number of Rows: **2**

Features

Product Type Features

Mixed & Hybrid Header	No
Connector Shape	Rectangular
PCB Connector Type	PCB Mount Header
Connector System	Wire-to-Board
Header Type	Fully Shrouded
Sealable	No
Connector & Contact Terminates To	Printed Circuit Board
Connector Product Type	Connector Assembly

Configuration Features

Number of Columns	6
Number of Loaded Positions	12
Number of Power Positions	12
Connector Contact Load Condition	Fully Loaded
PCB Mount Orientation	Right Angle



PCB Mount Header, Right Angle, Wire-to-Board, 12 Position, 3 mm [.118 in]
Centerline, Fully Shrouded, Gold (Au), Surface Mount, Micro MATE-N-LOK

Number of Positions	12
---------------------	----

Number of Rows	2
----------------	---

Electrical Characteristics

Operating Voltage	250 VDC
-------------------	---------

Body Features

PCB Retention Feature Material	Phosphor Bronze
--------------------------------	-----------------

PCB Retention Feature Plating Material	Tin
--	-----

Primary Product Color	Black
-----------------------	-------

Contact Features

Contact Underplating Material	Nickel
-------------------------------	--------

Contact Underplating Material Thickness	1.27 – 2.54 μm [50 – 100 μin]
---	--

PCB Contact Termination Area Plating Material Finish	Matte
--	-------

Contact Size	.64mm
--------------	-------

Contact Mating Area Plating Material Thickness	.76 μm [30 μin]
--	--

Mating Square Post Dimension	.64 mm[.025 in]
------------------------------	-----------------

PCB Contact Termination Area Plating Material Thickness	2.54 – 7.62 μm [100 – 300 μin]
---	---

Contact Shape & Form	Square
----------------------	--------

Contact Layout	Matrix
----------------	--------

Contact Mating Area Length	4.15 mm[.163 in]
----------------------------	------------------

Contact Base Material	Brass
-----------------------	-------

PCB Contact Termination Area Plating Material	Tin
---	-----

Contact Mating Area Plating Material	Gold (Au)
--------------------------------------	-----------

Contact Type	Tab
--------------	-----

Contact Current Rating (Max)	5 A
------------------------------	-----

Termination Features

Square Termination Post & Tail Dimension	.64 mm[.025 in]
--	-----------------

Termination Method to PCB	Surface Mount
---------------------------	---------------

Mechanical Attachment

Panel Mount Feature	Without
---------------------	---------

Mating Retention Type	Locking Tab
-----------------------	-------------

Mating Retention	With
------------------	------

Mating Alignment Type	Polarization
-----------------------	--------------



PCB Mount Header, Right Angle, Wire-to-Board, 12 Position, 3 mm [.118 in]
Centerline, Fully Shrouded, Gold (Au), Surface Mount, Micro MATE-N-LOK

PCB Mount Retention Type	Hold-Down
PCB Mount Retention	With
PCB Mount Alignment	Without
Connector Mounting Type	Board Mount
Mating Alignment	With

Housing Features

Mating Entry Location	Side
Housing Material	High Temperature Nylon
Centerline (Pitch)	3 mm [.118 in]

Dimensions

Row-to-Row Spacing	3 mm [.118 in]
PCB Thickness (Recommended)	1.57 mm [.062 in]
Connector Height	7.37 mm [.29 in]
Connector Length	22 mm [.866 in]

Usage Conditions

Operating Temperature (Max)	105 °C [221 °F]
Operating Temperature Range	-40 – 105 °C [-40 – 221 °F]

Operation/Application

Circuit Application	Power
---------------------	-------

Industry Standards

Compatible With Agency/Standards Products	CNR, USR
UL Rating	Recognized
Compatible With Approved Standards Products	UL E28476
Glow Wire Rating	GWT 750°C (Without Flame)
UL Flammability Rating	UL 94V-0

Packaging Features

Packaging Quantity	150
Packaging Method	Tape

Product Compliance

[For compliance documentation, visit the product page on TE.com>](#)

EU RoHS Directive 2011/65/EU	Compliant
------------------------------	-----------



PCB Mount Header, Right Angle, Wire-to-Board, 12 Position, 3 mm [.118 in] Centerline, Fully Shrouded, Gold (Au), Surface Mount, Micro MATE-N-LOK

EU ELV Directive 2000/53/EC

Compliant

China RoHS 2 Directive MIIT Order No 32, 2016

No Restricted Materials Above Threshold

EU REACH Regulation (EC) No. 1907/2006

Current ECHA Candidate List: JAN 2025 (247)

Candidate List Declared Against: JUNE 2024 (241)

Does not contain REACH SVHC

Halogen Content

Low Halogen - Br, Cl, F, I < 900 ppm per homogenous material. Also BFR/CFR/PVC Free

Solder Process Capability

Reflow solder capable to 260°C

Product Compliance Disclaimer

This information is provided based on reasonable inquiry of our suppliers and represents our current actual knowledge based on the information they provided. This information is subject to change. The part numbers that TE has identified as EU RoHS compliant have a maximum concentration of 0.1% by weight in homogenous materials for lead, hexavalent chromium, mercury, PBB, PBDE, DBP, BBP, DEHP, DIBP, and 0.01% for cadmium, or qualify for an exemption to these limits as defined in the Annexes of Directive 2011/65/EU (RoHS2). Finished electrical and electronic equipment products will be CE marked as required by Directive 2011/65/EU. Components may not be CE marked. Additionally, the part numbers that TE has identified as EU ELV compliant have a maximum concentration of 0.1% by weight in homogenous materials for lead, hexavalent chromium, and mercury, and 0.01% for cadmium, or qualify for an exemption to these limits as defined in the Annexes of Directive 2000/53/EC (ELV). Regarding the REACH Regulation, the information TE provides on SVHC in articles for this part number is based on the latest European Chemicals Agency (ECHA) 'Guidance on requirements for substances in articles' posted at this URL: <https://echa.europa.eu/guidance-documents/guidance-on-reach>

Compatible Parts



Also in the Series | Micro MATE-N-LOK

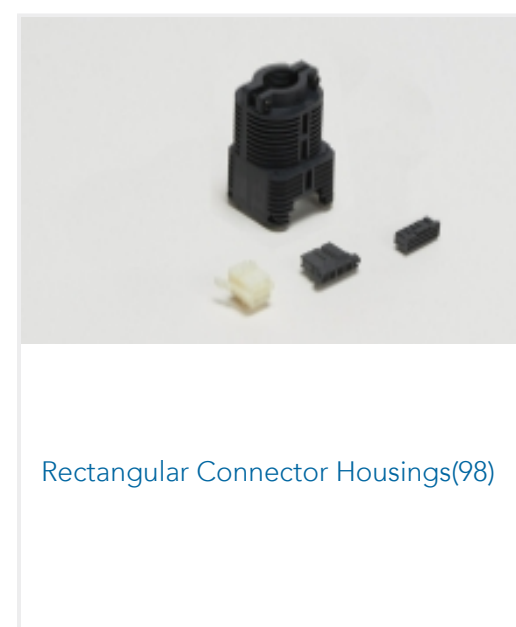
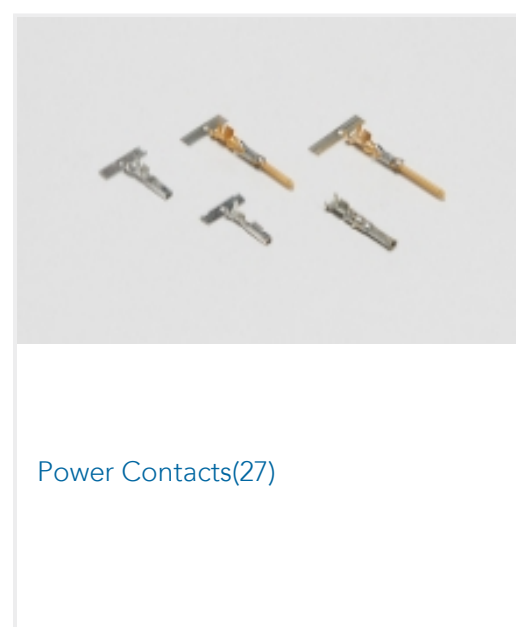
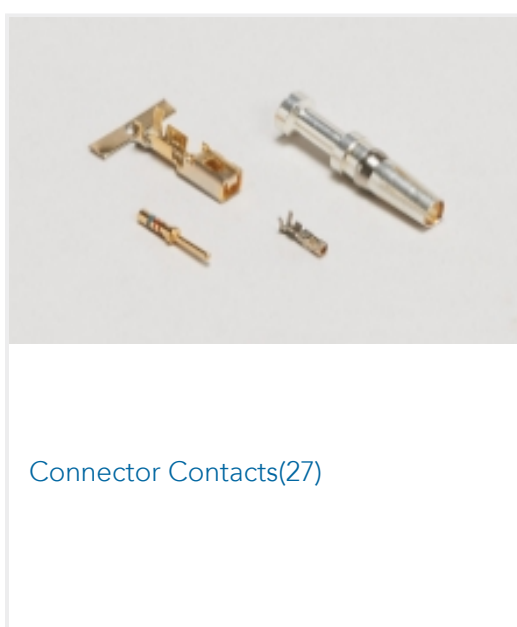

PCB Mount Header, Right Angle, Wire-to-Board, 12 Position, 3 mm [.118 in]
Centerline, Fully Shrouded, Gold (Au), Surface Mount, Micro MATE-N-LOK



Rectangular Power Connectors(469)

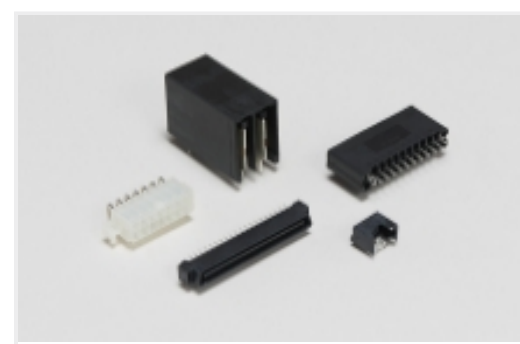

Standard Rectangular Connectors(98)

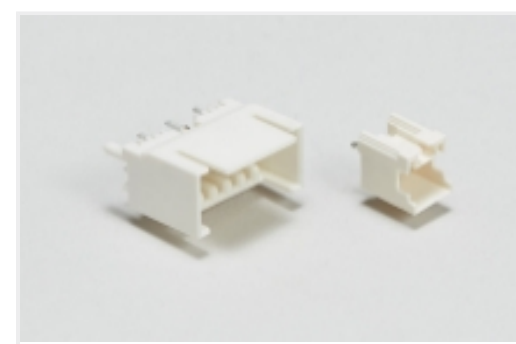

Wire-to-Board Headers & Receptacles
(371)

Customers Also Bought



TE Part #3-794629-6
06P MICRO MNL ASSY,R/A,SMT,LF



TE Part #2-2176090-7
RP 1J 0.166W 243K 0.1% 25PPM 1K RL



TE Part #3-2319764-2
E STACK PIANO 4P G LONG T&R PD
ON



TE Part #1879336-4
CPF 0603 249R 1% 50PPM 1K RL

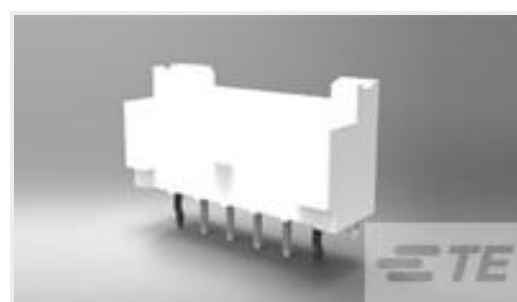

TE Part #2132230-3
EP2.5 Shrouded HDR ASSY 3P VER



TE Part #3-2176326-8
CRGP 0603 12K 1%



TE Part #796858-6
6 POS TERMI-BLOK PLUG RT ANGLE



TE Part #2118717-2
STD SHIELD COVER, CRS-26.71X26.
71X2.00MM



TE Part #4-794629-6
16P MICRO MNL ASSY,R/A,SMT,LF



TE Part #4-641210-2
12P MTA156 HDR FLRA FB 30AU LF

Documents

Product Drawings

[12P MICRO MNL ASSY,R/A,SMT,LF](#)

English

CAD Files

[3D PDF](#)

3D

[Customer View Model](#)

[ENG_CVM_CVM_4-794629-2_K.2d_dxf.zip](#)



PCB Mount Header, Right Angle, Wire-to-Board, 12 Position, 3 mm [.118 in]
Centerline, Fully Shrouded, Gold (Au), Surface Mount, Micro MATE-N-LOK

English

Customer View Model

[ENG_CVM_CVM_4-794629-2_K.3d_igs.zip](#)

English

Customer View Model

[ENG_CVM_CVM_4-794629-2_K.3d_stp.zip](#)

English

By downloading the CAD file I accept and agree to the [Terms and Conditions](#) of use.

Datasheets & Catalog Pages

[SOFT_SHELL_PIN_AND_SOCKET_CONNECTORS_CATALOG](#)

English

[MICRO MATE-N-LOK CONNECTOR SYSTEM](#)

English

Product Specifications

[Application Specification](#)

English

Agency Approvals

[VDE Certificate](#)

English

OUR CERTIFICATE

DiGi provide top-quality products and perfect service for customer worldwide through standardization, technological innovation and continuous improvement. DiGi through third-party certification, we stricly control the quality of products and services. Welcome your RFQ to Email: Info@DiGi-Electronics.com



Tel: +00 852-30501935

RFQ Email: Info@DiGi-Electronics.com

DiGi is a global authorized distributor of electronic components.