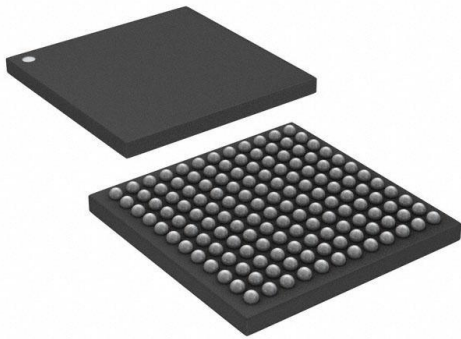


ADS4449IZCR Datasheet

www.digi-electronics.com



ADS4449IZCR

<https://www.DiGi-Electronics.com>

DiGi Electronics Part Number	ADS4449IZCR-DG
Manufacturer	Texas Instruments
Manufacturer Product Number	ADS4449IZCR
Description	IC ADC 14BIT PIPELINED 144NFBGA
Detailed Description	14 Bit Analog to Digital Converter 4 Input 2 Pipeline d 144-NFBGA (10x10)



Tel: +00 852-30501935

RFQ Email: Info@DiGi-Electronics.com

DiGi is a global authorized distributor of electronic components.

Purchase and inquiry

Manufacturer Product Number:

ADS4449IZCR

Series:

-

Number of Bits:

14

Number of Inputs:

4

Data Interface:

LVDS - Serial

Ratio - S/H:ADC:

1:1

Architecture:

Pipelined

Voltage - Supply, Analog:

1.8V ~ 2V

Features:

Simultaneous Sampling

Package / Case:

144-LFBGA

Mounting Type:

Surface Mount

Manufacturer:

Texas Instruments

Product Status:

Active

Sampling Rate (Per Second):

250M

Input Type:

Differential

Configuration:

S/H-ADC

Number of A/D Converters:

2

Reference Type:

External, Internal

Voltage - Supply, Digital:

1.7V ~ 2V

Operating Temperature:

-40°C ~ 85°C

Supplier Device Package:

144-NFBGA (10x10)

Base Product Number:

ADS4449

Environmental & Export classification

RoHS Status:

ROHS3 Compliant

REACH Status:

REACH Unaffected

HTSUS:

8542.39.0001

Moisture Sensitivity Level (MSL):

3 (168 Hours)

ECCN:

3A991C3

ADS4449 Quad-Channel, 14-Bit, 250-MSPS, Low-Power ADC

1 Features

- Quad Channel
- 14-Bit Resolution
- Maximum Sampling Data Rate: 250 MSPS
- Power Dissipation:
 - 365 mW per Channel
- Spectral Performance at 170-MHz IF (typ):
 - SNR: 69 dBFS
 - SFDR: 86 dBc
- DDR LVDS Digital Output Interface
- Internal Dither
- Package: 144-Terminal NFBGA (10.00 mm × 10.00 mm)

2 Applications

- Multi-Carrier GSM Cellular Infrastructure Base Stations
- RADAR and Smart Antenna Arrays
- Multi-Carrier Multi-Mode Cellular Infrastructure Base Stations
- Active Antenna Arrays for Wireless Infrastructures
- Communications Test Equipment

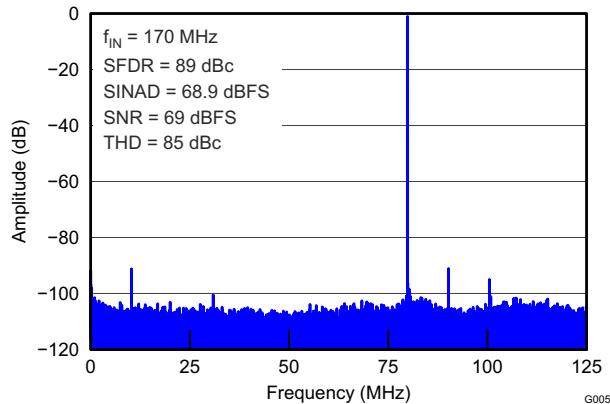
3 Description

The ADS4449 is a high-linearity, quad-channel, 14-bit, 250-MSPS, analog-to-digital converter (ADC). Designed for low power consumption and high spurious-free dynamic range (SFDR), the device has low-noise performance and outstanding SFDR over a large input frequency range.

Device Information

PART NUMBER	PACKAGE ⁽¹⁾	BODY SIZE (NOM)
ADS4449	NFBGA (144)	10.00 mm × 10.00 mm

- (1) For all available packages, see the orderable addendum at the end of the data sheet.



Spectrum for 170-MHz Input Frequency



Table of Contents

1 Features	1	8.2 Functional Block Diagram.....	21
2 Applications	1	8.3 Feature Description.....	22
3 Description	1	8.4 Device Functional Modes.....	24
4 Revision History	2	8.5 Programming.....	27
5 Pin Configuration and Functions	3	8.6 Register Maps.....	29
6 Specifications	5	9 Application and Implementation	43
6.1 Absolute Maximum Ratings.....	5	9.1 Application Information.....	43
6.2 ESD Ratings.....	5	9.2 Typical Application.....	43
6.3 Recommended Operating Conditions.....	5	10 Power Supply Recommendations	48
6.4 Thermal Information.....	6	11 Layout	49
6.5 Electrical Characteristics.....	7	11.1 Layout Guidelines.....	49
6.6 Digital Characteristics.....	9	11.2 Layout Example.....	49
6.7 Timing Requirements.....	10	12 Device and Documentation Support	50
6.8 Timing Characteristics, Serial interface.....	10	12.1 Device Nomenclature.....	50
6.9 Typical Characteristics.....	12	12.2 Documentation Support.....	51
6.10 Typical Characteristics: Contour.....	18	12.3 Receiving Notification of Documentation Updates.....	51
7 Parameter Measurement Information	19	12.4 Support Resources.....	51
7.1 LVDS Output Timing.....	19	12.5 Trademarks.....	51
8 Detailed Description	21	12.6 Electrostatic Discharge Caution.....	51
8.1 Overview.....	21	12.7 Glossary.....	51

4 Revision History

NOTE: Page numbers for previous revisions may differ from page numbers in the current version.

Changes from Revision A (April 2013) to Revision B (November 2020)	Page
• Added Low Sampling Rate mode to Table 8-2	24

Changes from Revision * (April 2013) to Revision A (January 2016)	Page
• Added <i>Internal Dither</i> Features bullet	1
• Added <i>ESD Ratings</i> table, <i>Feature Description</i> section, <i>Device Functional Modes</i> section, <i>Application and Implementation</i> section, <i>Power Supply Recommendations</i> section, <i>Layout</i> section, <i>Device and Documentation Support</i> section, and <i>Mechanical, Packaging, and Orderable Information</i> section.....	1
• Deleted Package and Ordering Information because the data is repeated in the Package Option Addendum	1
• Deleted SNRB from the configuration registers block in the functional block diagram	1
• Changed Clock Inputs, <i>Input clock sample rate</i> parameter minimum specification in Recommended Operating Conditions table.....	5
• Changed Table 8-1	23

5 Pin Configuration and Functions

	1	2	3	4	5	6	7	8	9	10	11	12
A	AVDD	AVDD	CINM	CINP	AVDD	VCM	VCM	AVDD	BINM	BINP	AVDD	AVDD
B	DINP	AVSS	AVDD	AVDD	AVSS	AVDD33	AVDD33	AVSS	AVDD	AVDD	AVSS	AINM
C	DINM	AVSS	AVSS	AVSS	AVSS	CLKINM	CLKINP	AVSS	AVSS	AVSS	AVSS	AINP
D	AVDD	AVDD	VCM	AVSS	AVSS	AVSS	AVSS	AVSS	AVSS	VCM	AVDD	AVDD
E	AVDD33	AVDD33	NC	DRVSS	DRVSS	DRVSS	DRVSS	DRVSS	DRVSS	PDN	AVDD33	AVDD33
F	DCD13M	DCD13P	DRVDD	DRVSS	DRVSS	DRVSS	DRVSS	DRVSS	DRVSS	DRVDD	DAB13P	DAB13M
G	DCD12M	DCD12P	NC	NC	NC	RESET	SCLK	SDATA	SEN	SDOUT	DAB12P	DAB12M
H	DCD11M	DCD11P	DCD6P	DCD6M	DRVDD	DRVDD	DRVDD	DRVDD	DAB6M	DAB6P	DAB11P	DAB11M
J	DCD10M	DCD10P	DCD5P	DCD5M	DCD2P	DRVDD	DRVDD	DAB2M	DAB5M	DAB5P	DAB10P	DAB10M
K	DCD9M	DCD9P	DCD4P	DCD4M	DCD2M	DRVDD	DRVDD	DAB2P	DAB4M	DAB4P	DAB9P	DAB9M
L	DCD8M	DCD8P	DCD3P	DCD3M	DCD1P	DCD1M	DAB1M	DAB1P	DAB3M	DAB3P	DAB8P	DAB8M
M	DCD7M	DCD7P	CLKOUT CDP	CLKOUT CDM	DCD0P/ OVRCDP	DCD0M/ OVRCDM	DAB0M/ OVRABM	DAB0P/ OVRABP	CLKOUT ABM	CLKOUT ABP	DAB7P	DAB7M

Figure 5-1. ZCR Package, 144-Pin NFBGA, Top View

ADS4449

SBAS603B – APRIL 2013 – REVISED NOVEMBER 2020

Table 5-1. Pin Functions

PIN		I/O	DESCRIPTION
NAME	NO.		
AINM	B12	I	Negative differential analog input for channel A
AINP	C12	I	Positive differential analog input for channel A
AVDD33	B6, B7, E1, E2, E11, E12	I	Analog 3.3-V power supply
AVDD	A1, A2, A5, A8, A11, A12, B3, B4, B9, B10, D1, D2, D11, D12	I	Analog 1.9-V power supply
AVSS	B2, B5, B8, B11, C2-C5, C8-C11, D4-D9	I	Analog ground
BINM	A9	I	Negative differential analog input for channel B
BINP	A10	I	Positive differential analog input for channel B
CINM	A3	I	Negative differential analog input for channel C
CINP	A4	I	Positive differential analog input for channel C
CLKINM	C6	I	Negative differential clock input
CLKINP	C7	I	Positive differential clock input
CLKOUTABM	M9	O	Negative differential LVDS clock output for channel A and B
CLKOUTABP	M10	O	Positive differential LVDS clock output for channel A and B
CLKOUTCDM	M4	O	Negative differential LVDS clock output for channels C and D
CLKOUTCDP	M3	O	Positive differential LVDS clock output for channels C and D
DAB[13:1]P, DAB0P/ OVRABP, DAB[13:1]M, DAB0M/ OVRABM	F11, F12, G11, G12, H9-H12, J8-J12, K8-K12, L7-L12, M7, M8, M11, M12	O	DDR LVDS outputs for channels A and B.
DCD[13:1]P, DCD0P/ OVRCDP, DCD[13:1]M, DCD0M/ OVRCDM	F1, F2, G1, G2, H1-H4, J1-J5, K1-K5, L1-L6, M1, M2, M5, M6	O	DDR LVDS outputs for channels C and D.
DINM	C1	I	Negative differential analog input for channel D
DINP	B1	I	Positive differential analog input for channel D
DRVDD	F3, F10, H5-H8, J6, J7, K6, K7	I	Digital 1.8-V power supply
DRVSS	E4-E9, F4-F9	I	Digital ground
NC	E3, G3, G4, G5	-	Do not connect
PDN	E10	I	Power-down control; active high. Logic high is power down.
RESET	G6	I	Hardware reset; active high
SCLK	G7	I	Serial interface clock input
SDATA	G8	I	Serial interface data input
SDOUT	G10	O	Serial interface data output
SEN	G9	I	Serial interface enable
VCM	A6, A7, D3, D10	O	Common-mode voltage for analog inputs. All VCM terminals are internally connected together.

6 Specifications

6.1 Absolute Maximum Ratings

over operating free-air temperature range (unless otherwise noted)⁽¹⁾

		MIN	MAX	UNIT
Supply voltage	AVDD33	-0.3	3.6	V
	AVDD	-0.3	2.1	
	DRVDD	-0.3	2.1	
Voltage between	AVSS and DRVSS	-0.3	0.3	V
	AVDD and DRVDD	-2.4	2.4	
	AVDD33 and DRVDD	-2.4	3.9	
	AVDD33 and AVDD	-2.4	3.9	
Voltage applied to input terminals	XINP, XINM	-0.3	minimum (1.9, AVDD + 0.3)	V
	CLKP, CLKM ⁽²⁾	-0.3	minimum (1.9, AVDD + 0.3)	
	RESET, SCLK, SDATA, SEN, PDN	-0.3	3.9	
Temperature	Operating free-air, T _A	-40	85	°C
	Operating junction, T _J		150	
	Storage, T _{stg}	-65	150	

- (1) Stresses beyond those listed under *Absolute Maximum Ratings* may cause permanent damage to the device. These are stress ratings only, which do not imply functional operation of the device at these or any other conditions beyond those indicated under [Section 6.3](#). Exposure to absolute-maximum-rated conditions for extended periods may affect device reliability.
- (2) When AVDD is turned off, TI recommends switching off the input clock (or ensuring the voltage on CLKP and CLKM is less than |0.3 V|). This recommendation prevents the ESD protection diodes at the clock input terminals from turning on.

6.2 ESD Ratings

		VALUE	UNIT
V _(ESD) Electrostatic discharge	Human-body model (HBM), per ANSI/ESDA/JEDEC JS-001 ⁽¹⁾	±2000	V
	Charged-device model (CDM), per JEDEC specification JESD22-C101 ⁽²⁾	±500	

- (1) JEDEC document JEP155 states that 500-V HBM allows safe manufacturing with a standard ESD control process.
- (2) JEDEC document JEP157 states that 250-V CDM allows safe manufacturing with a standard ESD control process.

6.3 Recommended Operating Conditions

over operating free-air temperature range (unless otherwise noted)

		MIN	NOM	MAX	UNIT
SUPPLIES					
AVDD33	Supply voltage	3.15	3.3	3.45	V
AVDD		1.8	1.9	2	V
DRVDD		1.7	1.8	2	V
ANALOG INPUTS					
Differential input voltage range		2			V _{PP}
V _{IC}	Input common-mode voltage	V _{CM} ± 0.025			V
Analog input common-mode current (per input terminal of each channel)		1.5			µA/MSPS
VCM current capability		5			mA
Maximum analog input frequency	2-V _{PP} input amplitude ⁽²⁾	400			MHz
	1.4-V _{PP} input amplitude	500			
CLOCK INPUTS					
Input clock sample rate ⁽¹⁾		10	250		MSPS

ADS4449

SBAS603B – APRIL 2013 – REVISED NOVEMBER 2020

6.3 Recommended Operating Conditions (continued)

over operating free-air temperature range (unless otherwise noted)

		MIN	NOM	MAX	UNIT
Input clock amplitude differential ($V_{CLKP} - V_{CLKM}$)	Sine wave, ac-coupled	0.2	1.5		V_{PP}
	LVPECL, ac-coupled		1.6		
	LVDS, ac-coupled		0.7		
	LVC MOS, single-ended, ac-coupled		1.8		
Input clock duty cycle		40%	50%	60%	
DIGITAL OUTPUTS					
C_{LOAD}	Maximum external load capacitance from each output terminal to DRVSS (default strength)		3.3		pF
R_{LOAD}	Differential load resistance between the LVDS output pairs (LVDS mode)		100		Ω
TEMPERATURE RANGE					
T_A	Operating free-air temperature	-40		85	$^{\circ}C$
T_J	Operating junction temperature	Recommended		105	$^{\circ}C$
		Maximum rated ⁽²⁾		125	

(1) When input clock sample rate is below 200 MSPS Low Sample Rate Mode is required.

(2) Prolonged use at this junction temperature may increase the device failure-in-time (FIT) rate.

6.4 Thermal Information

THERMAL METRIC ⁽¹⁾		ADS4449	UNIT
		ZCR (NFBGA)	
		144 PINS	
$R_{\theta JA}$	Junction-to-ambient thermal resistance	35.9	$^{\circ}C/W$
$R_{\theta JC(top)}$	Junction-to-case (top) thermal resistance	5.1	$^{\circ}C/W$
$R_{\theta JB}$	Junction-to-board thermal resistance	12.6	$^{\circ}C/W$
Ψ_{JT}	Junction-to-top characterization parameter	0.1	$^{\circ}C/W$
Ψ_{JB}	Junction-to-board characterization parameter	12.4	$^{\circ}C/W$
$R_{\theta JC(bot)}$	Junction-to-case (bottom) thermal resistance	N/A	$^{\circ}C/W$

(1) For more information about traditional and new thermal metrics, see the *Semiconductor and IC Package Thermal Metrics* application report, [SPRA953](#).

6.5 Electrical Characteristics

Typical values are at $T_A = 25^\circ\text{C}$, full temperature range is $T_{\text{MIN}} = -40^\circ\text{C}$ to $T_{\text{MAX}} = 85^\circ\text{C}$, ADC clock frequency = 250 MHz, 50% clock duty cycle, $\text{AVDD33V} = 3.3\text{ V}$, $\text{AVDD} = 1.9\text{ V}$, $\text{DRVDD} = 1.8\text{ V}$, and -1-dBFS differential input, unless otherwise noted.

PARAMETER		TEST CONDITIONS	MIN	TYP	MAX	UNITS	
RESOLUTION							
Default resolution				14		Bits	
ANALOG INPUTS							
Differential input full-scale				2		V_{PP}	
VCM	Common mode input voltage			1.15		V	
R_{IN}	Input resistance, differential	At 170-MHz input frequency		700		Ω	
C_{IN}	Input capacitance, differential	At 170-MHz input frequency		3.3		pF	
Analog input bandwidth, 3 dB		with a 50- Ω source driving the ADC analog inputs		500		MHz	
DYNAMIC ACCURACY							
E_{O}	Offset error	Specified across devices and channels	-15		15	mV	
E_{G}	Gain error ⁽²⁾	As a result of internal reference inaccuracy alone	Specified across devices and channels	-5		5	%FS
		Of channel alone	Specified across channels within a device		± 0.2		
Channel gain error temperature coefficient ⁽²⁾				0.001		$\Delta\%/^\circ\text{C}$	
POWER SUPPLY⁽¹⁾							
I_{AVDD33}	Supply current	3.3-V analog supply		51		mA	
I_{AVDD}		1.9-V analog supply		350		mA	
I_{DRVDD}		1.8-V digital supply		355		mA	
P_{TOTAL}	Power dissipation	Total		1.47	1.6	W	
$P_{\text{DISS(standby)}}$		Standby		400		mW	
$P_{\text{DISS(global)}}$		Global power-down		6	52	mW	
DYNAMIC AC CHARACTERISTICS							
SNR	Signal-to-noise ratio	$f_{\text{IN}} = 40\text{ MHz}$		71.1		dBFS	
		$f_{\text{IN}} = 70\text{ MHz}$		71			
		$f_{\text{IN}} = 140\text{ MHz}$		69.5			
		$f_{\text{IN}} = 170\text{ MHz}$	67.5	69			
		$f_{\text{IN}} = 220\text{ MHz}$		68.5			
		$f_{\text{IN}} = 307\text{ MHz}$		67.5			
		$f_{\text{IN}} = 350\text{ MHz}$		67			
SINAD	Signal-to-noise and distortion ratio	$f_{\text{IN}} = 40\text{ MHz}$		70.9		dBFS	
		$f_{\text{IN}} = 70\text{ MHz}$		70.8			
		$f_{\text{IN}} = 140\text{ MHz}$		69.3			
		$f_{\text{IN}} = 170\text{ MHz}$	66.9	68.8			
		$f_{\text{IN}} = 220\text{ MHz}$		68.3			
		$f_{\text{IN}} = 307\text{ MHz}$		66.8			
		$f_{\text{IN}} = 350\text{ MHz}$		66.3			
SFDR	Spurious-free dynamic range	$f_{\text{IN}} = 40\text{ MHz}$		84		dBc	
		$f_{\text{IN}} = 70\text{ MHz}$		87			
		$f_{\text{IN}} = 140\text{ MHz}$		85			
		$f_{\text{IN}} = 170\text{ MHz}$	78.5	86			
		$f_{\text{IN}} = 220\text{ MHz}$		84			
		$f_{\text{IN}} = 307\text{ MHz}$		78			
		$f_{\text{IN}} = 350\text{ MHz}$		77			

ADS4449

SBAS603B – APRIL 2013 – REVISED NOVEMBER 2020

6.5 Electrical Characteristics (continued)

Typical values are at $T_A = 25^\circ\text{C}$, full temperature range is $T_{\text{MIN}} = -40^\circ\text{C}$ to $T_{\text{MAX}} = 85^\circ\text{C}$, ADC clock frequency = 250 MHz, 50% clock duty cycle, $\text{AVDD33V} = 3.3\text{ V}$, $\text{AVDD} = 1.9\text{ V}$, $\text{DRVDD} = 1.8\text{ V}$, and -1-dBFS differential input, unless otherwise noted.

PARAMETER		TEST CONDITIONS	MIN	TYP	MAX	UNITS
THD	Total harmonic distortion	$f_{\text{IN}} = 40\text{ MHz}$		83		dBc
		$f_{\text{IN}} = 70\text{ MHz}$		84		
		$f_{\text{IN}} = 140\text{ MHz}$		82		
		$f_{\text{IN}} = 170\text{ MHz}$	75	83		
		$f_{\text{IN}} = 220\text{ MHz}$		82		
		$f_{\text{IN}} = 307\text{ MHz}$		76		
		$f_{\text{IN}} = 350\text{ MHz}$		75		
HD2	Second-order harmonic distortion ⁽³⁾ ⁽⁴⁾	$f_{\text{IN}} = 40\text{ MHz}$		96		dBc
		$f_{\text{IN}} = 70\text{ MHz}$		87		
		$f_{\text{IN}} = 140\text{ MHz}$		86		
		$f_{\text{IN}} = 170\text{ MHz}$	78.5	86		
		$f_{\text{IN}} = 220\text{ MHz}$		84		
		$f_{\text{IN}} = 307\text{ MHz}$		78		
		$f_{\text{IN}} = 350\text{ MHz}$		77		
HD3	Third-order harmonic distortion	$f_{\text{IN}} = 40\text{ MHz}$		83		dBc
		$f_{\text{IN}} = 70\text{ MHz}$		89		
		$f_{\text{IN}} = 140\text{ MHz}$		85		
		$f_{\text{IN}} = 170\text{ MHz}$	79.5	86		
		$f_{\text{IN}} = 220\text{ MHz}$		85		
		$f_{\text{IN}} = 307\text{ MHz}$		80		
		$f_{\text{IN}} = 350\text{ MHz}$		78		
Worst spur (non HD2, HD3)		$f_{\text{IN}} = 40\text{ MHz}$		100		dBc
		$f_{\text{IN}} = 70\text{ MHz}$		100		
		$f_{\text{IN}} = 140\text{ MHz}$		95		
		$f_{\text{IN}} = 170\text{ MHz}$	87	95		
		$f_{\text{IN}} = 220\text{ MHz}$,		95		
		$f_{\text{IN}} = 307\text{ MHz}$		85		
		$f_{\text{IN}} = 350\text{ MHz}$		85		
DNL	Differential nonlinearity		-0.95	± 0.5		LSBs
INL	Integral nonlinearity			± 1.5	± 5.25	LSBs
	Input overload recovery	Recovery to within 1% (of final value) for 6-dB output overload with sine-wave input		1		Clock cycle
	Crosstalk	with a full-scale, 220-MHz signal on aggressor channel and no signal on victim channel		90		dB
PSRR	AC power-supply rejection ratio	For 50-mV _{pp} signal on AVDD supply		< 30		dB

- (1) A 185-MHz, full-scale, sine-wave input signal is applied to all four channels.
- (2) There are two sources of gain error: internal reference inaccuracy and channel gain error.
- (3) Phase and amplitude imbalances onboard must be minimized to obtain good performance.
- (4) The minimum value across temperature is ensured by bench characterization.

6.6 Digital Characteristics

The dc specifications refer to the condition where the digital outputs are not switching, but are permanently at a valid logic level 0 or 1. AVDD33 = 3.3 V, AVDD = 1.9 V, and DRVDD = 1.8 V, unless otherwise noted.

PARAMETER		TEST CONDITIONS	MIN	TYP	MAX	UNIT
DIGITAL INPUTS⁽¹⁾ (RESET, SCLK, SDATA, SEN, PDN)						
V _{IH}	High-level input voltage	All digital inputs support 1.8-V logic levels. SPI supports 3.3-V logic levels.	1.25			V
V _{IL}	Low-level input voltage	All digital inputs support 1.8-V logic levels. SPI supports 3.3-V logic levels.			0.45	V
I _{IH}	High-level input current	RESET, SCLK, PDN terminals	V _{HIGH} = 1.8 V	10		μA
		SEN ⁽²⁾ terminal	V _{HIGH} = 1.8 V	0		
I _{IL}	Low-level input current	RESET, SCLK, PDN terminals	V _{LOW} = 0 V	0		μA
		SEN terminal	V _{LOW} = 0 V	10		
DIGITAL OUTPUTS (SDOUT)						
V _{OH}	High-level output voltage		DRVDD – 0.1	DRVDD		V
V _{OL}	Low-level output voltage			0	0.1	V
DIGITAL OUTPUTS, LVDS INTERFACE (DAB[13:0]P, DAB[13:0]M, DCD[13:0]P, DCD[13:0]M, CLKOUTABP, CLKOUTABM, CLKOUTCDP, CLKOUTCDM)						
V _{ODH}	High-level output differential voltage ⁽³⁾	Standard-swing LVDS	270	350	465	mV
V _{ODL}	Low-level output differential	Standard-swing LVDS	–465	–350	–270	mV
V _{OCM}	Output common-mode voltage			1.05		V

(1) RESET, SDATA, and SCLK have an internal 150-kΩ pull-down resistor.

(2) SEN has an internal 150-kΩ pull-up resistor to DRVDD.

(3) with an external 100-Ω termination.

ADS4449

SBAS603B – APRIL 2013 – REVISED NOVEMBER 2020

6.7 Timing Requirements

Typical values are at 25°C, AVDD33 = 3.3 V, AVDD = 1.9 V, DRVDD = 1.8 V, sine-wave input clock, C_{LOAD} = 3.3 pF⁽²⁾, and R_{LOAD} = 100 Ω⁽³⁾, unless otherwise noted.

Minimum and maximum values are across the full temperature range of T_{MIN} = –40°C to T_{MAX} = 85°C.

See Note ⁽¹⁾		MIN	NOM	MAX	UNIT		
t _A	Aperture delay	0.7	1.2	1.6	ns		
	Aperture delay matching	Between any two channels of the same device		±70	ps		
	Variation of aperture delay	Between two devices at the same temperature and DRVDD supply		±150	ps		
t _J	Aperture jitter		140		fs rms		
	Wake up time	Time to valid data after coming out of global power down		100	μs		
		Time to valid data after coming out of channel power down		10			
ADC latency ^{(4) (5)}	Default latency in 14-bit mode		10	Output clock cycles			
	Digital gain enabled		13				
	Digital gain and offset correction enabled		14				
OUTPUT TIMING⁽⁶⁾							
t _{SU}	Data setup time ^{(7) (8) (9)}	Data valid to CLKOUTxxP zero-crossing		0.6	0.85	ns	
t _H	Data hold time ^{(7) (8) (9)}	CLKOUTxxP zero-crossing to data becoming invalid		0.6	0.84	ns	
	LVDS bit clock duty cycle	Differential clock duty cycle (CLKOUTxxP – CLKOUTxxM)		50%			
t _{PDI}	Clock propagation delay ⁽⁵⁾	Input clock falling edge cross-over to output clock falling edge cross-over, 184 MSPS ≤ sampling frequency ≤ 250 MSPS		0.25 × t _S + t _{delay}		ns	
t _{delay}	Delay time	Input clock falling edge cross-over to output clock falling edge cross-over, 184 MSPS ≤ sampling frequency ≤ 250 MSPS		6.9	8.65	10.5	ns
t _{RISE} , t _{FALL}	Data rise and fall time	Rise time measured from –100 mV to 100 mV		0.1		ns	
t _{CLKRISE} , t _{CLKFALL}	Output clock rise and fall time	Rise time measured from –100 mV to 100 mV		0.1		ns	

- (1) Timing parameters are ensured by design and characterization and are not tested in production.
- (2) C_{LOAD} is the effective external single-ended load capacitance between each output terminal and ground.
- (3) R_{LOAD} is the differential load resistance between the LVDS output pair.
- (4) ADC latency is given for channels B and D. For channels A and C, latency reduces by half of the output clock cycles.
- (5) Overall latency = ADC latency + t_{PDI}.
- (6) Measurements are done with a transmission line of 100-Ω characteristic impedance between the device and load. Setup and hold time specifications take into account the effect of jitter on the output data and clock.
- (7) Data valid refers to a logic high of 100 mV and a logic low of –100 mV.
- (8) Note that these numbers are taken with delayed output clocks by writing the following registers: **address A9h, value 02h**; and **address ACh, value 60h**. Refer to the section. By default after reset, minimum setup time and minimum hold times are 520 ps each.
- (9) The setup and hold times of a channel are measured with respect to the same channel output clock.

6.8 Timing Characteristics, Serial interface

see Figure 6-1		MIN	NOM	MAX	UNIT
f _{SCLK}	SCLK frequency (equal to 1 / t _{SCLK})	> dc		20	MHz
t _{SLOADS}	SEN to SCLK setup time	25			ns
t _{SLOADH}	SCLK to SEN hold time	25			ns
t _{DSU}	SDI setup time	25			ns
t _{DH}	SDI hold time	25			ns

Table 6-1. LVDS Timings Across Lower Sampling Frequencies

SAMPLING FREQUENCY (MSPS)	SETUP TIME (ns)			HOLD TIME (ns)		
	MIN	TYP	MAX	MIN	TYP	MAX
210	0.89	1.03		0.82	1.01	
185	1.06	1.21		0.95	1.15	

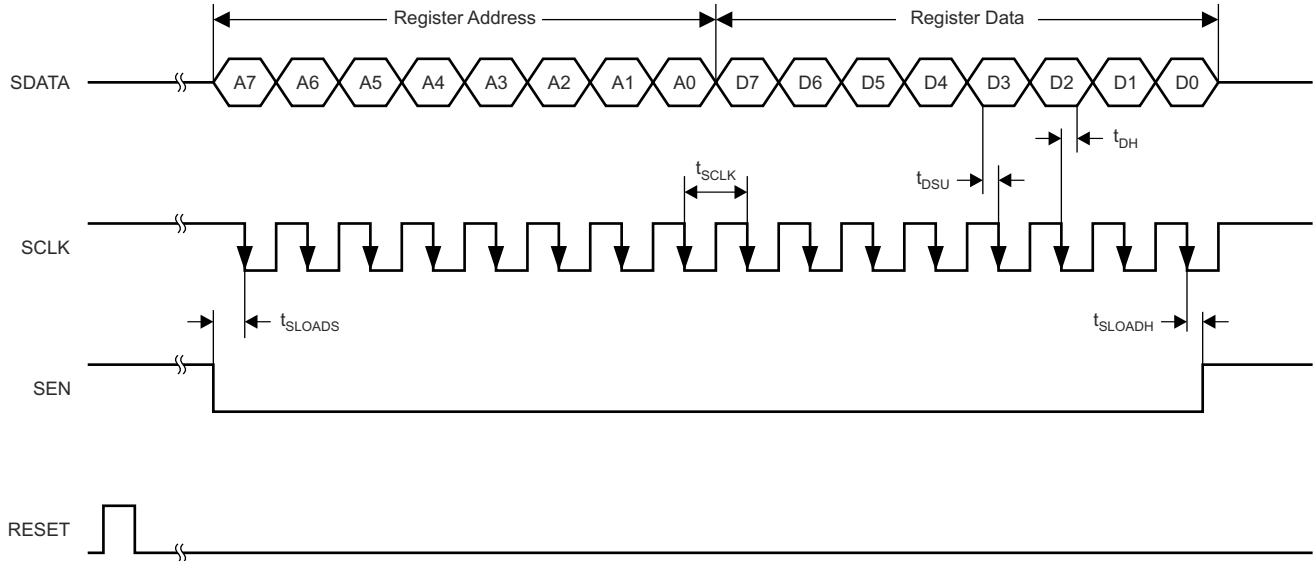


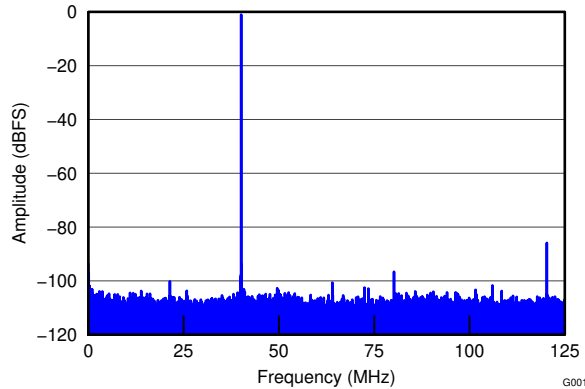
Figure 6-1. Serial Interface Timing

ADS4449

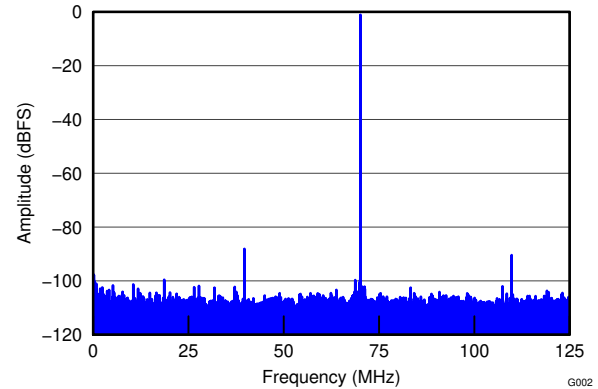
SBAS603B – APRIL 2013 – REVISED NOVEMBER 2020

6.9 Typical Characteristics

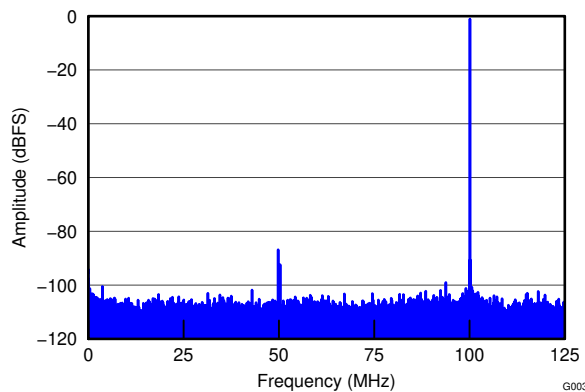
At 25°C, AVDD = 1.9 V, AVDD3V = 3.3 V, DRVDD = 1.8 V, rated sampling frequency, 0-dB gain, sine-wave input clock, 1.5-V_{PP} differential clock amplitude, 50% clock duty cycle, -1-dBFS differential analog input, DDR LVDS output interface, and 32k-point FFT, unless otherwise noted.



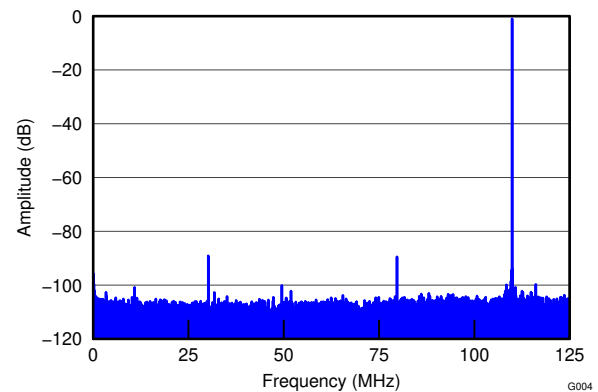
$f_{IN} = 40$ MHz SFDR = 84 dBc SNR = 71.1 dBFS
SINAD = 70.9 dBFS THD = 84 dBc

Figure 6-2. FFT for 40-MHz Input Signal

$f_{IN} = 70$ MHz SFDR = 87 dBc SNR = 70.9 dBFS
SINAD = 70.8 dBFS THD = 84 dBc

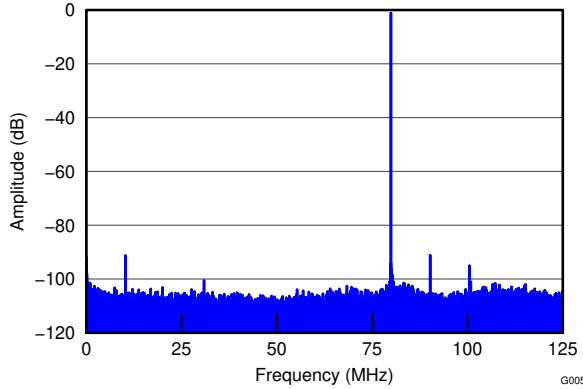
Figure 6-3. FFT for 70-MHz Input Signal

$f_{IN} = 100$ MHz SFDR = 85 dBc SNR = 70.2 dBFS
SINAD = 70.1 dBFS THD = 84 dBc

Figure 6-4. FFT for 100-MHz Input Signal

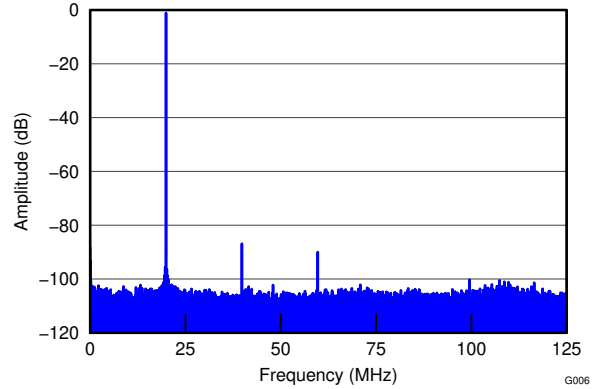
$f_{IN} = 140$ MHz SFDR = 87 dBc SNR = 69.7 dBFS
SINAD = 69.6 dBFS THD = 84 dBc

Figure 6-5. FFT for 140-MHz Input Signal



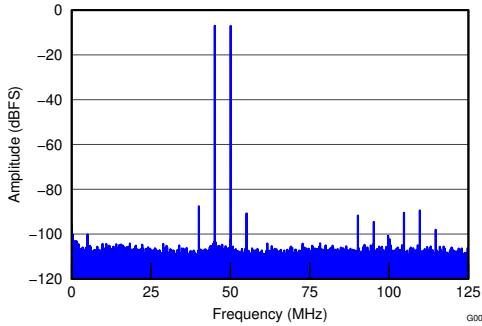
$f_{IN} = 170 \text{ MHz}$ SFDR = 89 dBc SNR = 69 dBFS
SINAD = 68.9 dBFS THD = 85 dBc

Figure 6-6. FFT for 170-MHz Input Signal



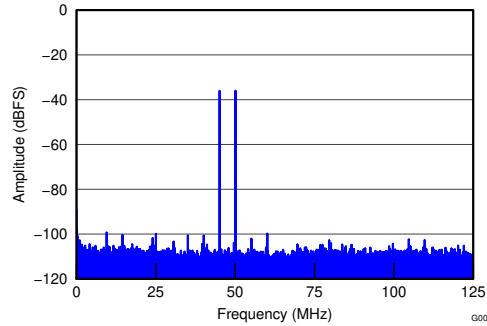
$f_{IN} = 230 \text{ MHz}$ SFDR = 86 dBc SNR = 68.9 dBFS
SINAD = 68.5 dBFS THD = 84 dBc

Figure 6-7. FFT for 230-MHz Input Signal



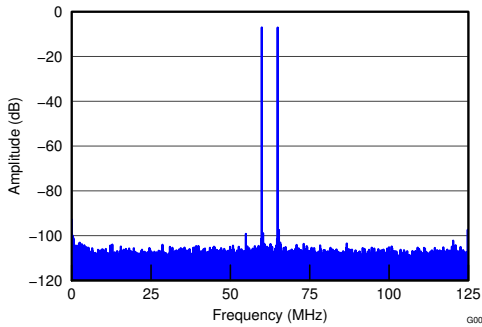
Each Tone at -7-dBFS Amplitude
 $f_{IN1} = 45 \text{ MHz}$ $f_{IN2} = 50 \text{ MHz}$ SFDR = 92 dBFS
2-Tone IMD = 87 dBFS

Figure 6-8. FFT for Two-Tone Input Signal



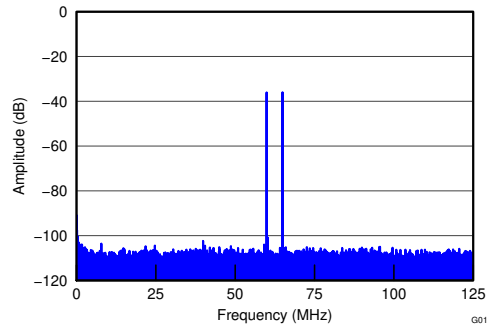
Each Tone at -36-dBFS Amplitude
 $f_{IN1} = 45 \text{ MHz}$ $f_{IN2} = 50 \text{ MHz}$ SFDR = 99 dBFS
2-Tone IMD = 99 dBFS

Figure 6-9. FFT for Two-Tone Input Signal



Each Tone at -7-dBFS Amplitude
 $f_{IN1} = 185.1 \text{ MHz}$ $f_{IN2} = 190.1 \text{ MHz}$ SFDR = 102 dBFS
2-Tone IMD = 97 dBFS

Figure 6-10. FFT for Two-Tone Input Signal



Each Tone at -36-dBFS Amplitude
 $f_{IN1} = 185.1 \text{ MHz}$ $f_{IN2} = 190.1 \text{ MHz}$ SFDR = 100 dBFS
2-Tone IMD = 101 dBFS

Figure 6-11. FFT for Two-Tone Input Signal

ADS4449

SBAS603B – APRIL 2013 – REVISED NOVEMBER 2020

www.ti.com

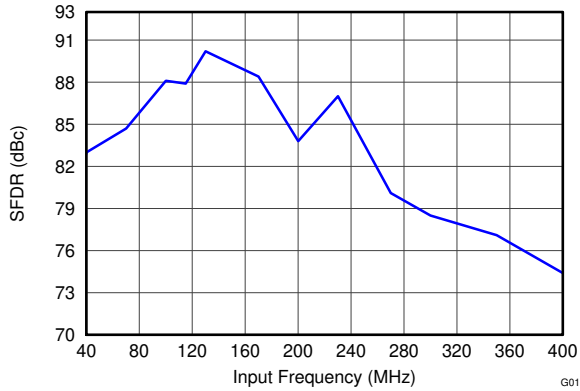
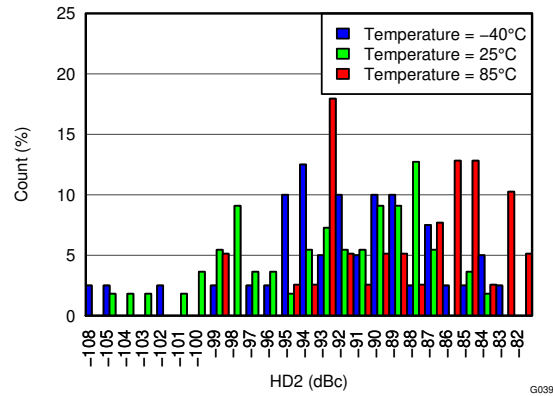


Figure 6-12. Spurious-Free Dynamic Range vs Input Frequency



Input Frequency = 170 MHz

Figure 6-13. HD2 Distribution over Multiple Devices

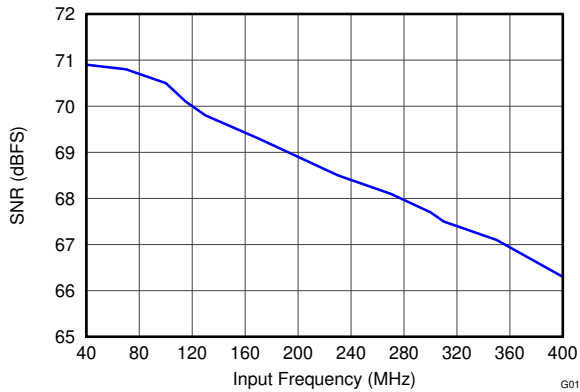


Figure 6-14. Signal-to-Noise Ratio vs Input Frequency

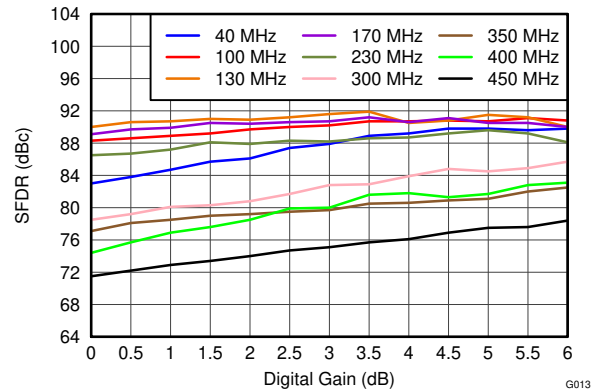


Figure 6-15. Spurious-Free Dynamic Range vs Digital Gain

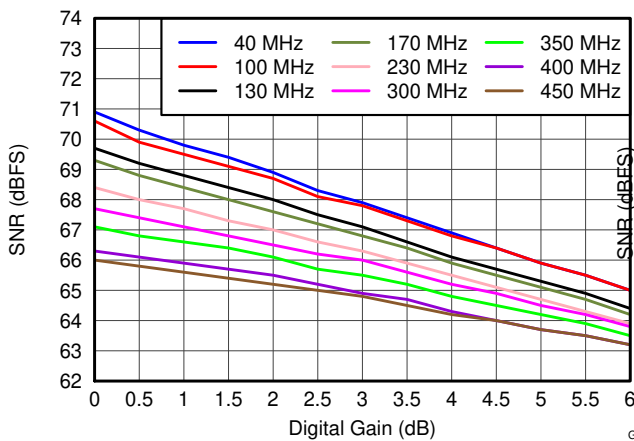


Figure 6-16. Signal-to-Noise Ratio vs Digital Gain

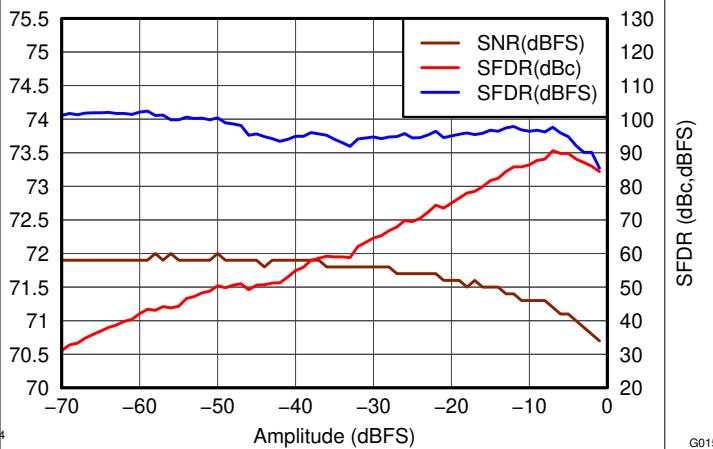


Figure 6-17. Performance vs Input Amplitude

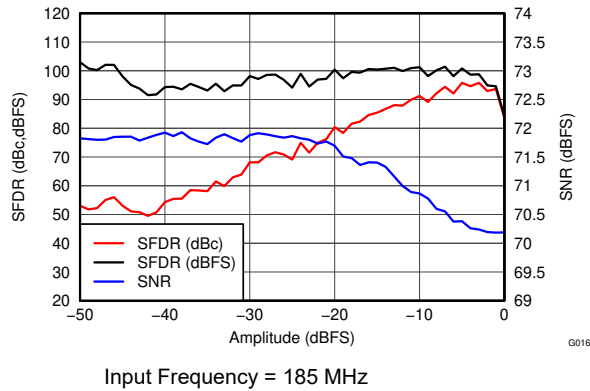


Figure 6-18. Performance vs Input Amplitude

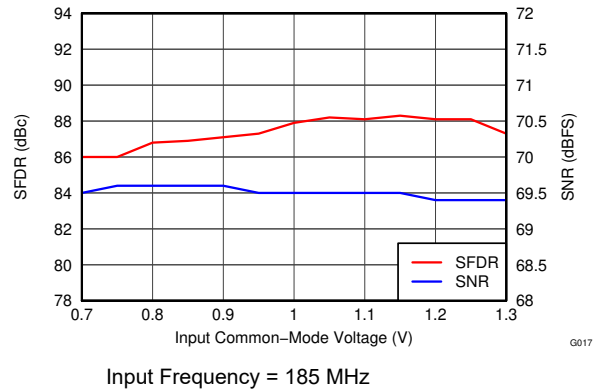


Figure 6-19. Performance vs Input Common-Mode Voltage

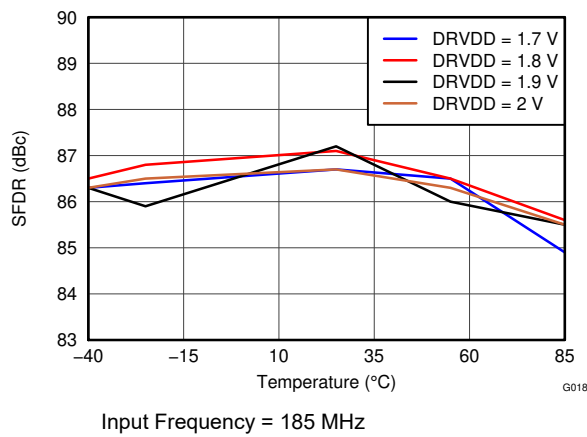


Figure 6-20. Spurious-Free Dynamic Range vs DRVDD Supply and Temperature

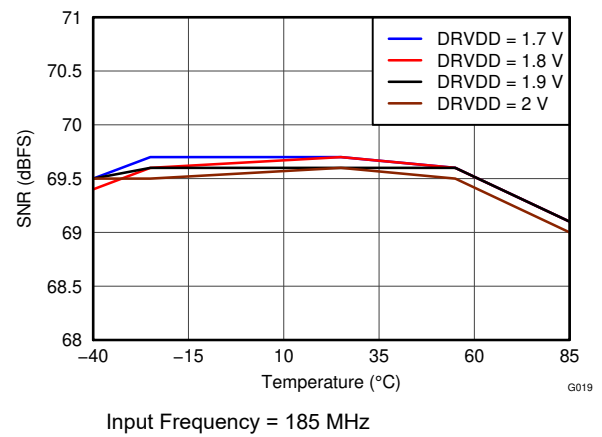


Figure 6-21. Signal-to-Noise Ratio vs DRVDD Supply and Temperature

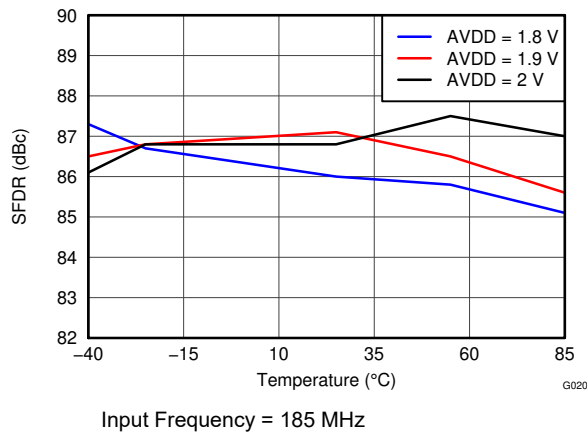


Figure 6-22. Spurious-Free Dynamic Range vs AVDD Supply and Temperature

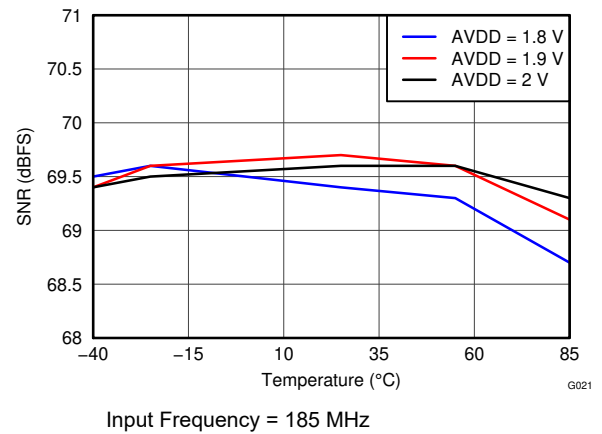


Figure 6-23. Signal-to-Noise Ratio vs AVDD Supply and Temperature

ADS4449

SBAS603B – APRIL 2013 – REVISED NOVEMBER 2020

www.ti.com

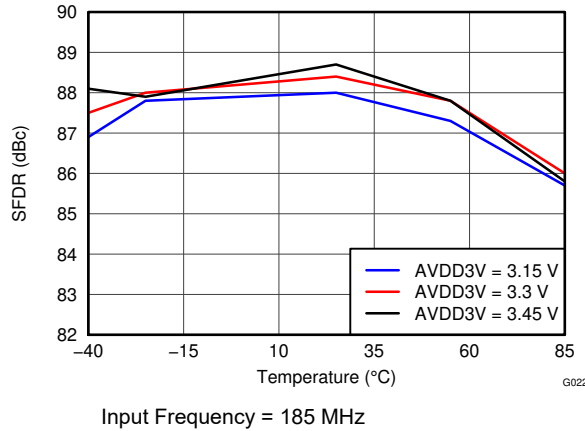


Figure 6-24. Spurious-Free Dynamic Range vs AVDD3V Supply and Temperature

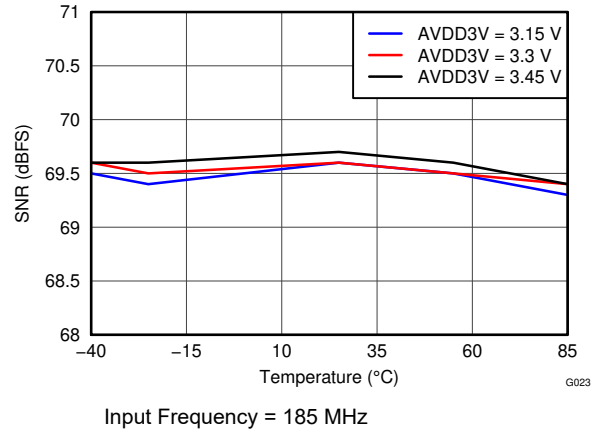


Figure 6-25. Signal-to-Noise Ratio vs AVDD3V Supply and Temperature

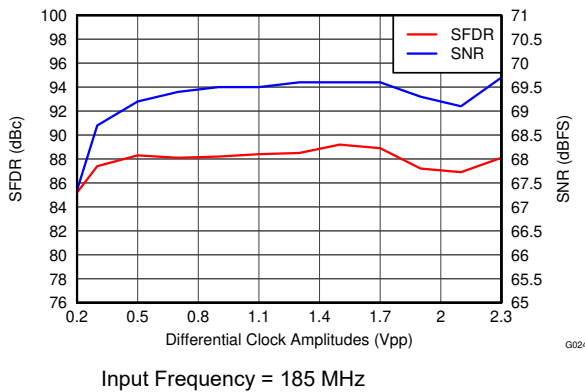


Figure 6-26. Performance vs Clock Amplitude

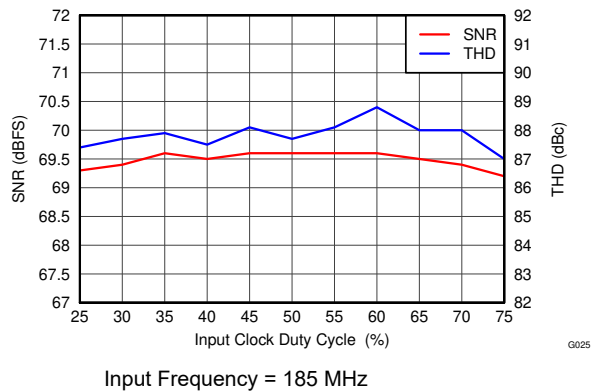


Figure 6-27. Performance vs Clock Duty Cycle

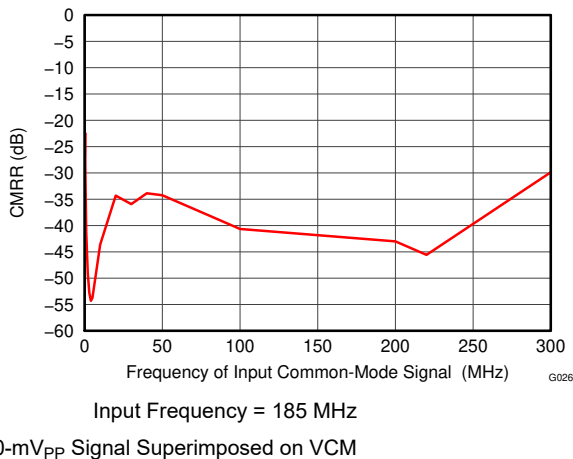


Figure 6-28. Common-Mode Rejection Ratio Spectrum

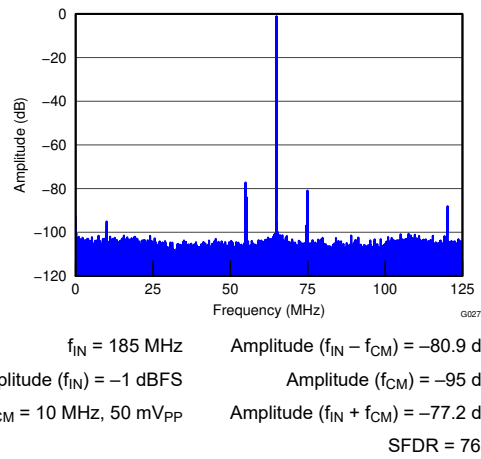
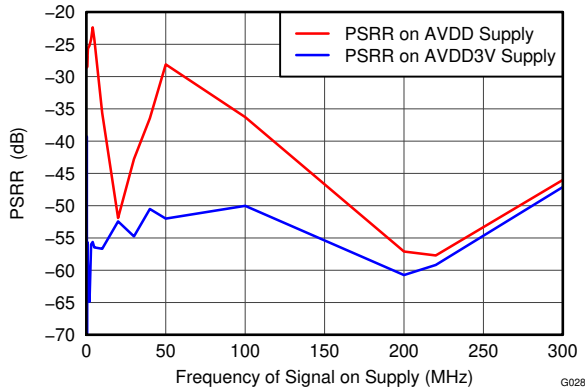
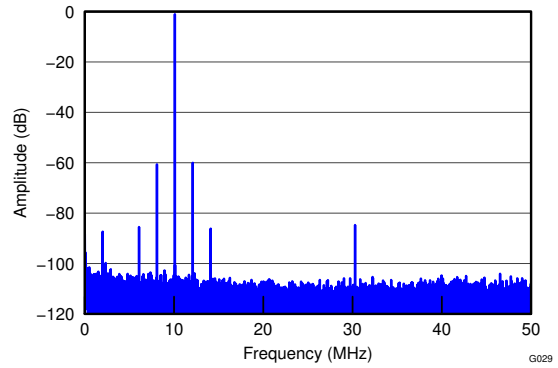


Figure 6-29. Common-Mode Rejection Ratio vs Test Signal Frequency



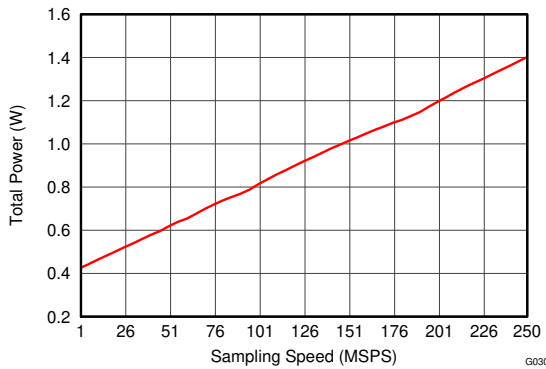
Input Frequency = 10 MHz
50-mV_{PP} Signal Superimposed on Supply

Figure 6-30. Power-Supply Rejection Ratio Spectrum for AVDD



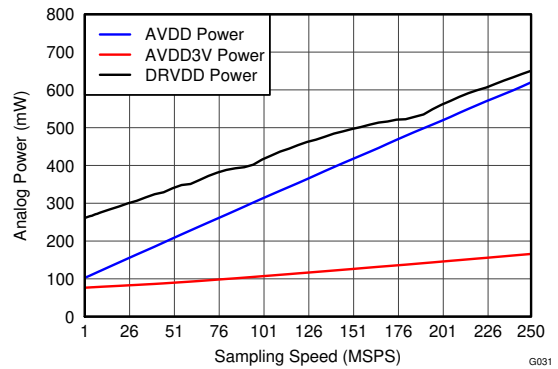
Amplitude (f_{IN}) = -1 dBFS Amplitude (f_{PSRR}) = -87 dBFS
 f_{IN} = 10 MHz Amplitude ($f_{IN} + f_{PSRR}$) = -60.6 dBFS
 f_{PSRR} = 2 MHz, 50 mV_{PP} Amplitude ($f_{IN} - f_{PSRR}$) = -60 dBFS

Figure 6-31. Power-Supply Rejection Ratio vs Test Signal Frequency



Input Frequency = 185 MHz

Figure 6-32. Total Power vs Sampling Frequency



Input Frequency = 185 MHz

Figure 6-33. Power Breakup vs Sampling Frequency

ADS4449

SBAS603B – APRIL 2013 – REVISED NOVEMBER 2020

6.10 Typical Characteristics: Contour

At 25°C, AVDD = 1.9 V, AVDD3V = 3.3 V, DRVDD = 1.8 V, rated sampling frequency, 0-dB gain, sine-wave input clock, 1.5-V_{PP} differential clock amplitude, 50% clock duty cycle, -1-dBFS differential analog input, DDR LVDS output interface, and 32k-point FFT, unless otherwise noted.

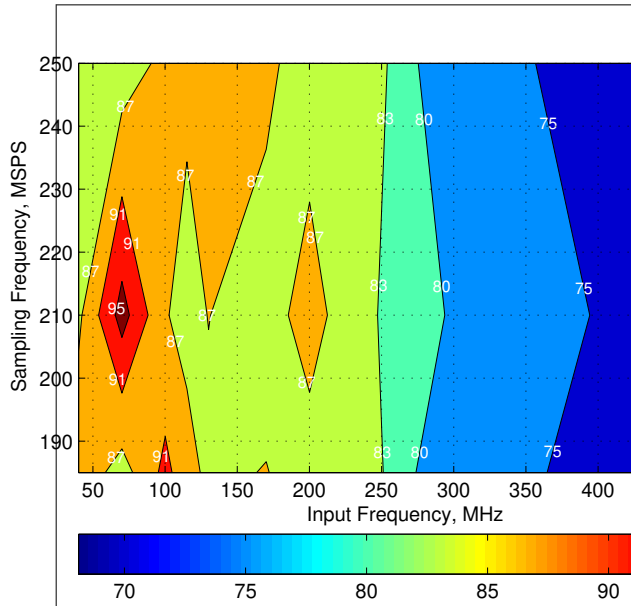


Figure 6-34. Spurious-Free Dynamic Range (0-dB Gain)

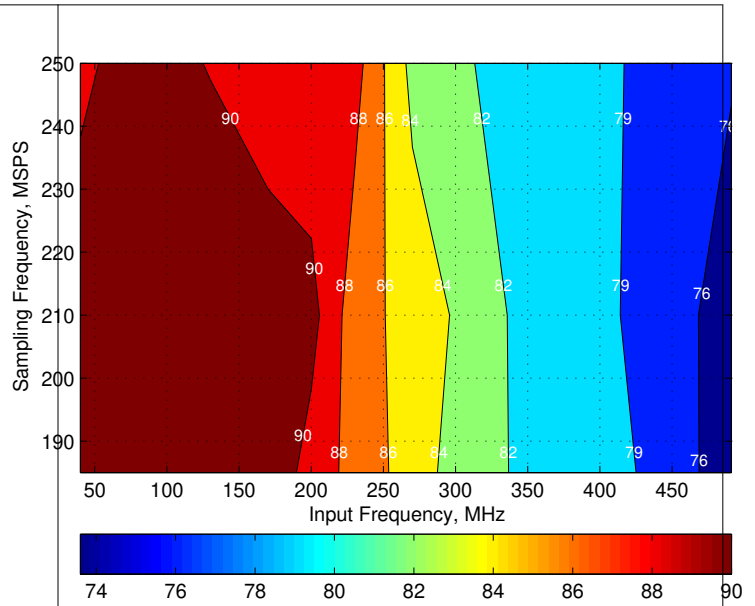


Figure 6-35. Spurious-Free Dynamic Range (6-dB Gain)

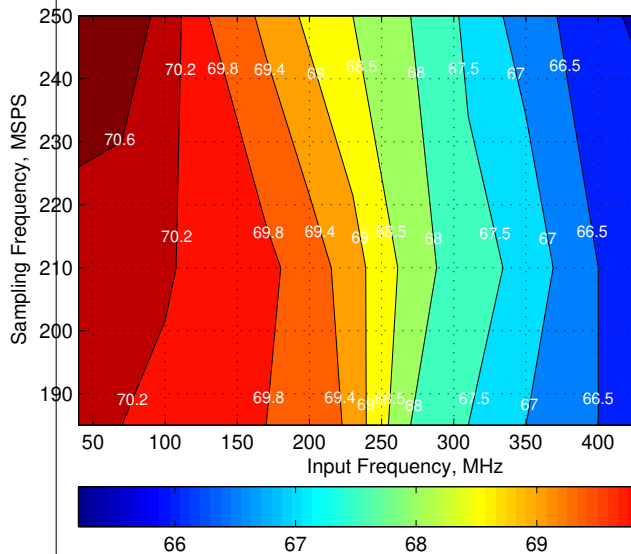


Figure 6-36. Signal-to-Noise Ratio (0-dB Gain)

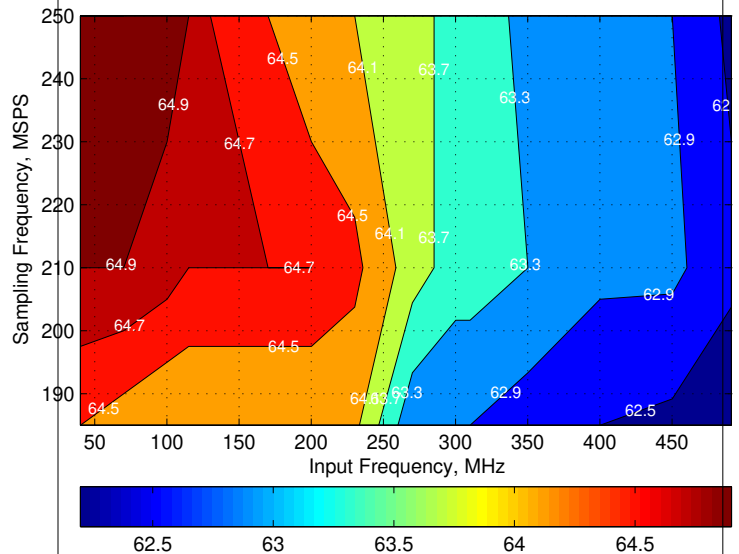


Figure 6-37. Signal-to-Noise Ratio (6-dB Gain)

7 Parameter Measurement Information

7.1 LVDS Output Timing

Figure 7-1 shows a timing diagram of the LVDS output voltage levels. Figure 7-2 shows the latency described in the Section 6.7 table.

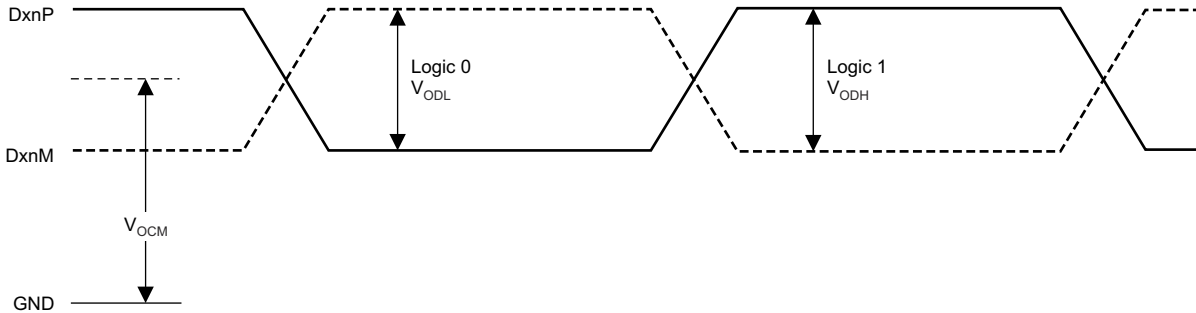


Figure 7-1. LVDS Output Voltage Levels

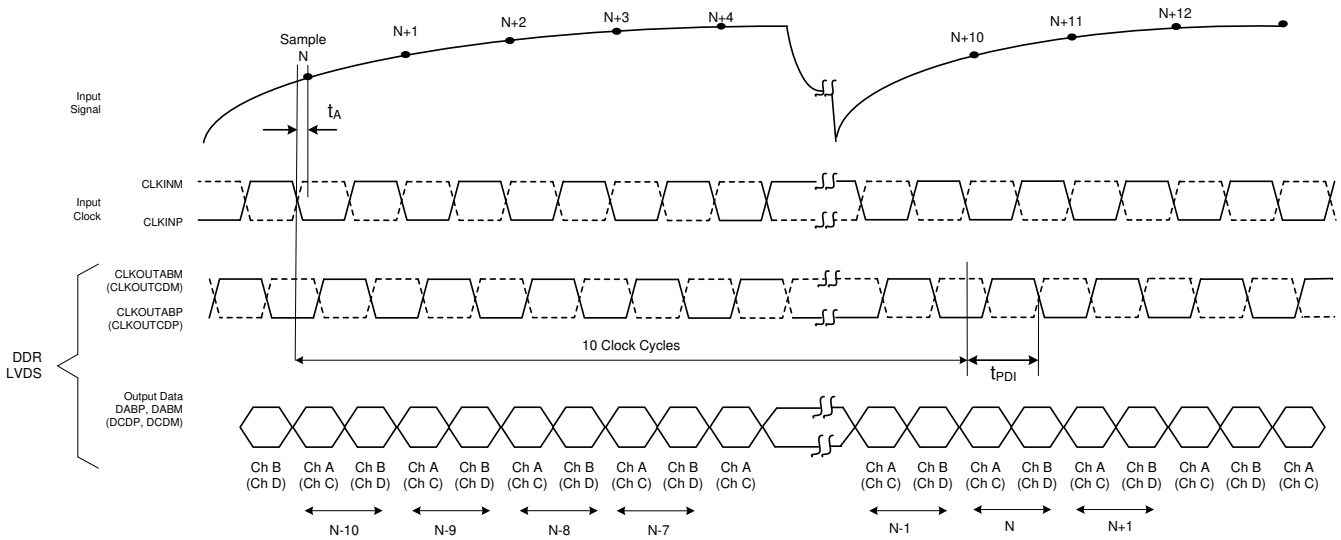


Figure 7-2. Latency Timing

All 14 data bits of one channel are included in the digital output interface at the same time, as shown in Figure 7-3. Channel A and C data are output on the rising edge of the output clock while channels B and D are output on the falling edge of the output clock.

ADS4449

SBAS603B – APRIL 2013 – REVISED NOVEMBER 2020

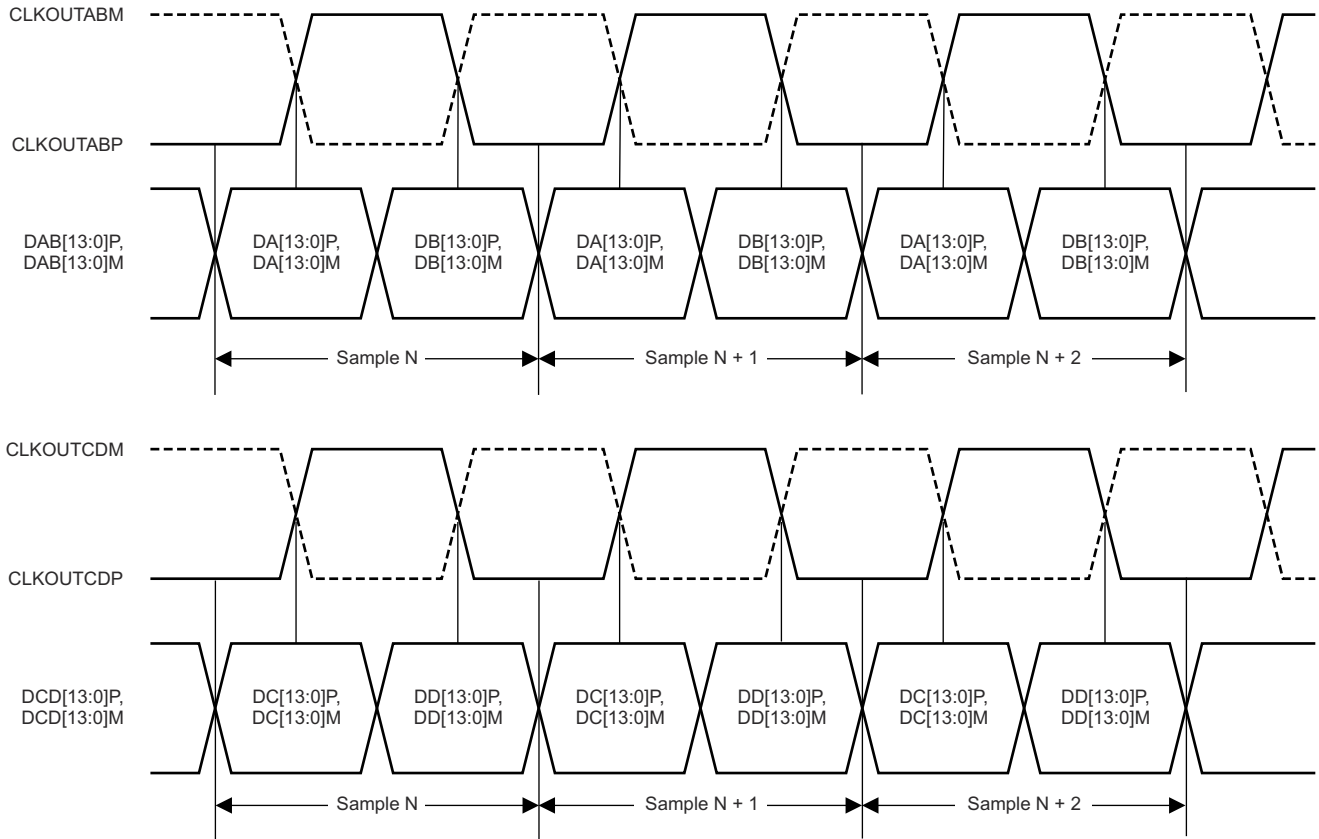


Figure 7-3. LVDS Output Interface Timing

8 Detailed Description

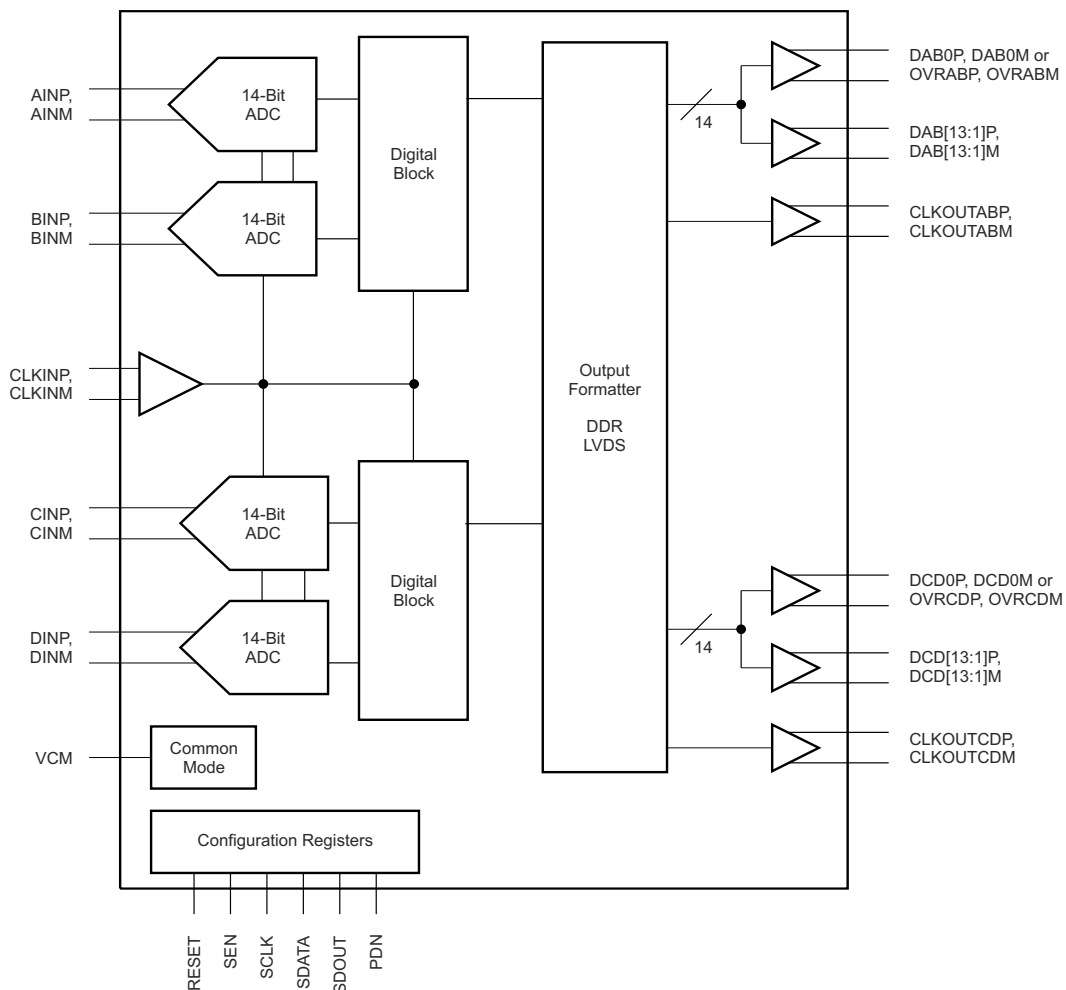
8.1 Overview

The ADS4449 belongs to TI's low-power family of quad-channel, 14-bit, analog-to-digital converters (ADCs). High performance is maintained while power is reduced for power-sensitive applications. In addition to its low power and high performance, the ADS4449 has a number of digital features and operating modes to enable design flexibility.

At every falling edge of the input clock, the analog input signal for each channel is sampled simultaneously. The sampled signal in each channel is converted by a pipeline of low-resolution stages. In each stage, the sampled-and-held signal is converted by a high-speed, low-resolution, flash sub-ADC. The difference (residue) between the stage input and quantized equivalent is gained and propagates to the next stage. At every clock, each subsequent stage resolves the sampled input with greater accuracy. The digital outputs from all stages are combined in a digital correction logic block and are digitally processed to create the final code, after a data latency of 10 clock cycles. The digital output is available in a double data rate (DDR) low-voltage differential signaling (LVDS) interface and is coded in binary two's complement format.

The ADS4449 can be configured with a serial programming interface (SPI), as described in the [Section 8.5.1](#) section. In addition, the device has control terminals that control power-down.

8.2 Functional Block Diagram



ADS4449

SBAS603B – APRIL 2013 – REVISED NOVEMBER 2020

8.3 Feature Description**8.3.1 Overrange Indication (OVRxx)**

After reset, all serial interface register "ALWAYS WRITE 1". Bits must be set to 1. Afterwards, 13-bit data are output on the Dxx13P, Dxx13M to Dxx1P, Dxx1M terminals and overrange information is output on the Dxx0P and Dxx0M terminals (where xx = channels A and B or channels C and D).

When the DIS OVR ON LSB bit is set to 1, 14-bit data are output on the Dxx13P, Dxx13M to Dxx0P, Dxx0M terminals without overrange information on the LSB bits.

The OVR timing diagram (13-bit data with OVR) is shown in [Figure 8-1](#). In 14-bit mode, OVR is disabled by setting the DIS OVR ON LSB bit to 1, as shown in [Figure 8-2](#).

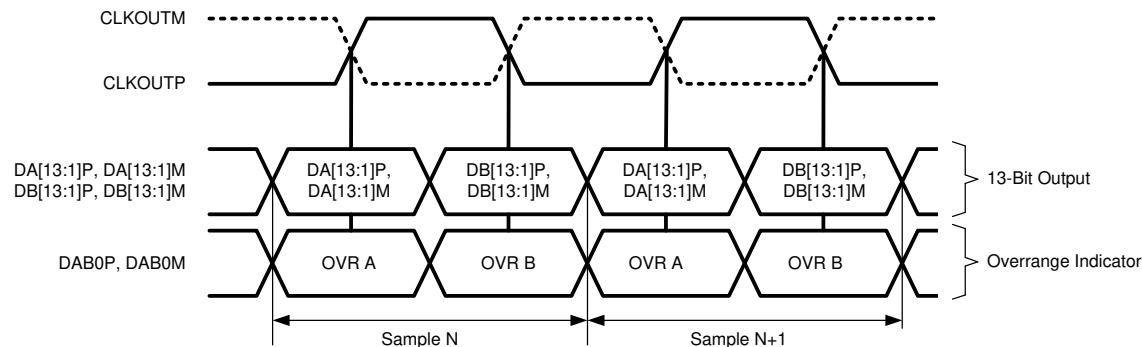


Figure 8-1. 13-Bit Data with OVR (Register Bits ALWAYS WRITE 1 = 1 and DIS OVR ON LSB = 0)

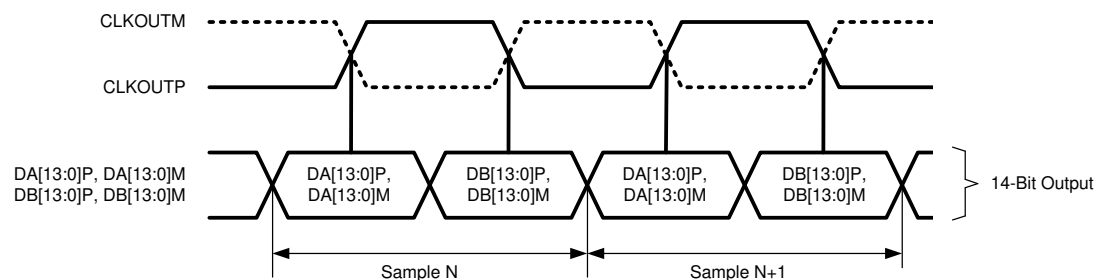


Figure 8-2. 14-Bit Mode (Register Bits ALWAYS WRITE 1 = 1 and DIS OVR ON LSB = 1)

Normal overrange indication (OVR) shows the event of the device digital output being saturated when the input signal exceeds the ADC full-scale range. Normal OVR has the same latency as digital output data. However, an overrange event can be indicated earlier (than normal latency) by using the fast OVR mode. The fast OVR mode (enabled by default) is triggered seven clock cycles after the overrange condition that occurred at the ADC input. The fast OVR thresholds are programmable with the FAST OVR THRESH PROG bits (refer to [Table 8-3](#), register address C3h). At any time, either normal or fast OVR mode can be programmed on the Dxx0P and Dxx0M terminals.

8.3.2 Gain for SFDR and SNR Trade-Off

The device includes gain settings that can be used to obtain improved SFDR performance. The gain is programmable from 0 dB to 6 dB (in 0.5-dB steps) using the DIGITAL GAIN CH X register bits. For each gain setting, the analog input full-scale range scales proportionally, as shown in [Table 8-1](#).

Table 8-1. Full-Scale Range Across Gains

GAIN (dB)	TYPE	FULL-SCALE (V_{PP})
0	Default after reset	2
0.5	Fine, programmable	1.89
1	Fine, programmable	1.78
1.5	Fine, programmable	1.68
2	Fine, programmable	1.59
2.5	Fine, programmable	1.5
3	Fine, programmable	1.42
3.5	Fine, programmable	1.34
4	Fine, programmable	1.26
4.5	Fine, programmable	1.19
5	Fine, programmable	1.12
5.5	Fine, programmable	1.06
6	Fine, programmable	1

SFDR improvement is achieved at the expense of SNR; for each gain setting, SNR degrades by approximately 0.5 dB to 1 dB. SNR degradation is diminished at high input frequencies. As a result, fine gain is very useful at high input frequencies because SFDR improvement is significant with marginal degradation in SNR. Therefore, fine gain can be used to trade-off between SFDR and SNR.

After a reset, the gain function is disabled. To use fine gain:

- First, program the DIGITAL ENABLE bits to enable digital functions.
- This setting enables the gain for all four channels and places the device in a 0-dB gain mode.
- For other gain settings, program the DIGITAL GAIN CH X register bits.

ADS4449

SBAS603B – APRIL 2013 – REVISED NOVEMBER 2020

8.4 Device Functional Modes**8.4.1 Special Performance Modes**

Best performance can be achieved by writing certain modes depending upon source impedance, band of operation and sampling speed. [Table 8-2](#) summarizes the different these modes.

Table 8-2. High-Performance Modes Summary

SPECIAL MODES SUMMARY ⁽¹⁾				
SPECIAL MODE NAME	ADDRESS (Hex)	DATA (Hex)	INPUT FREQUENCIES (Up to 125 MHz)	INPUT FREQUENCIES (> 125 MHz)
High-frequency mode	F1	20	Not required	Must
High SNR mode ⁽²⁾	58	20	Optional	Optional
	70	20	Optional	Optional
	88	20	Optional	Optional
	A0	20	Optional	Optional
SPECIAL MODE NAME	ADDRESS (Hex)	DATA (Hex)	SAMPLING RATE (Up to 200 MSPS)	SAMPLING RATE (>200MHz)
Low Sampling Rate mode	4A	1	Must	Not required
	62	1	Must	Not required
	7A	1	Must	Not required
	92	1	Must	Not required

(1) See the [Section 8.5.1](#) section for details.

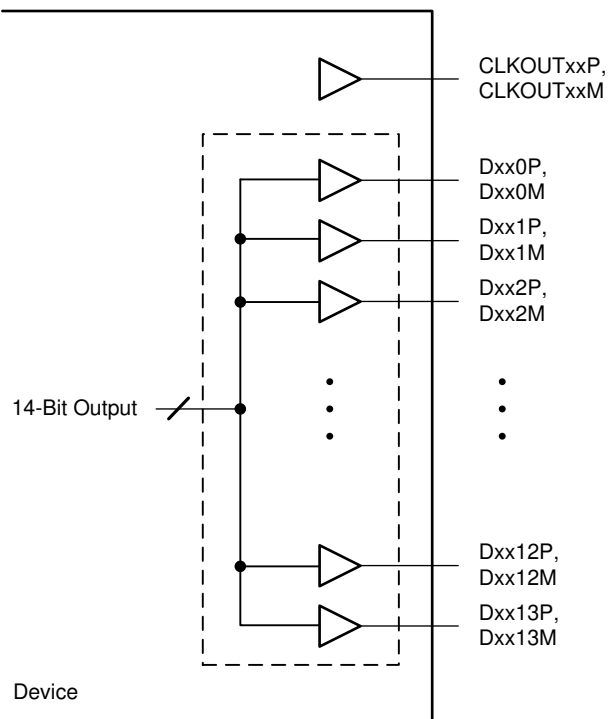
(2) High SNR mode improves SNR typically by 1 dB at 170 MHz input frequency. See the [Section 8.4.3](#) section.

8.4.2 Digital Output Information

The device provides 14-bit digital data for each channel and two output clocks in LVDS mode. Output terminals are shared by a pair of channels that are accompanied by one dedicated output clock.

8.4.2.1 DDR LVDS Outputs

In the LVDS interface mode, the data bits and clock are output using LVDS levels. The data bits of two channels are multiplexed and output on each LVDS differential pair of terminals; see [Figure 8-3](#) and [Figure 8-4](#).



NOTE: xx = channels A and B or C and D.

Figure 8-3. DDR LVDS Interface

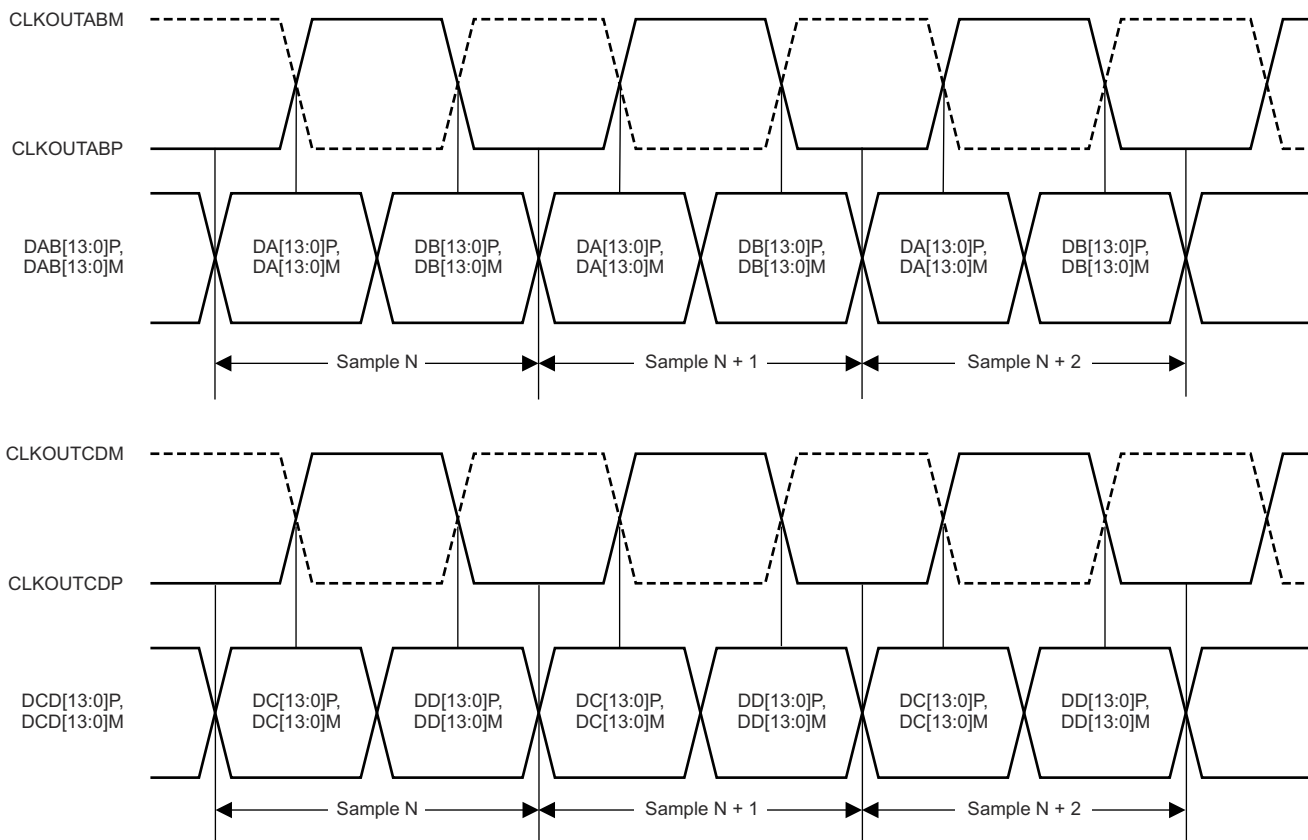


Figure 8-4. DDR LVDS Interface Timing Diagram

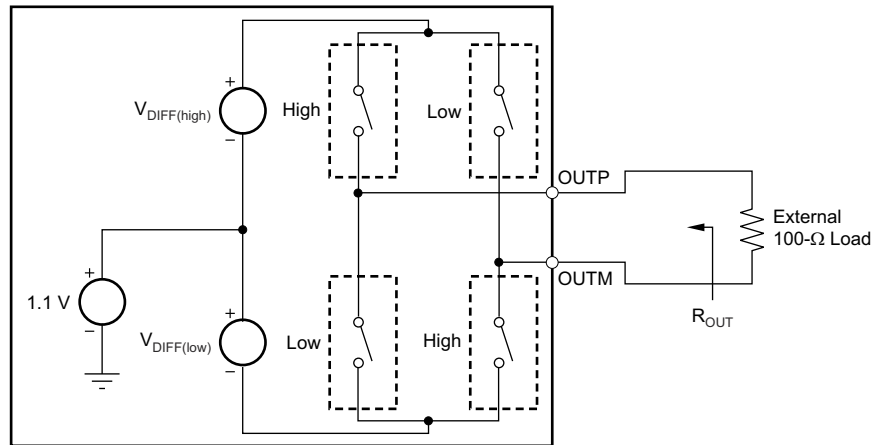
ADS4449

SBAS603B – APRIL 2013 – REVISED NOVEMBER 2020

8.4.2.1.1 LVDS Output Data and Clock Buffers

The equivalent circuit of each LVDS output buffer is shown in [Figure 8-5](#). After reset, the buffer presents an output impedance of 100 Ω to match with the external 100- Ω termination.

The V_{DIFF} voltage is nominally 350 mV, resulting in an output swing of ± 350 mV with 100- Ω external termination. The V_{DIFF} voltage is programmable using the LVDS SWING register bits (refer to [Table 8-3](#), register address 01h). The buffer output impedance behaves similar to a source-side series termination. By absorbing reflections from the receiver end, the source-side termination helps improve signal integrity.

**Figure 8-5. LVDS Buffer Equivalent Circuit****8.4.2.1.2 Output Data Format**

The device transmits data in binary two's complement format. In the event of an input voltage overdrive, the digital outputs go to the appropriate full-scale level. For a positive overdrive, the output code is 3FFh. For a negative input overdrive, the output code is 400h.

8.4.3 Using High SNR Mode Register Settings

The HIGH SNR MODE register settings can be used to further improve the SNR. However, there is a trade off between improved SNR and degraded THD when these settings are used. These settings shut down the internal spectrum-cleaning algorithm, resulting in THD performance degradation. [Figure 8-6](#) and [Figure 8-7](#) show the effect of using HIGH SNR MODE. SNR improves by approximately 1 dB and THD degrades by 3 dB.

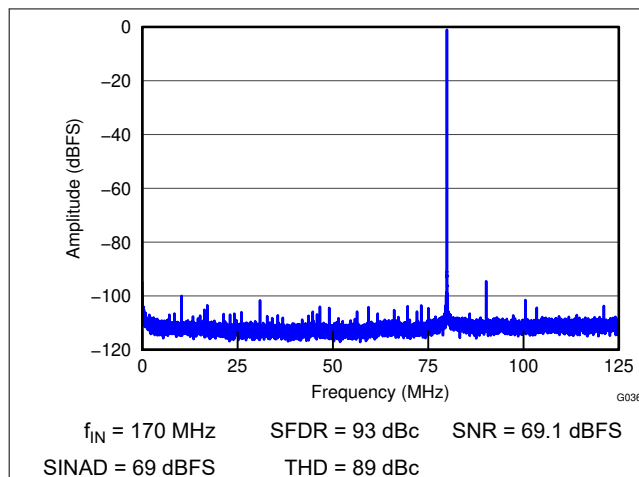
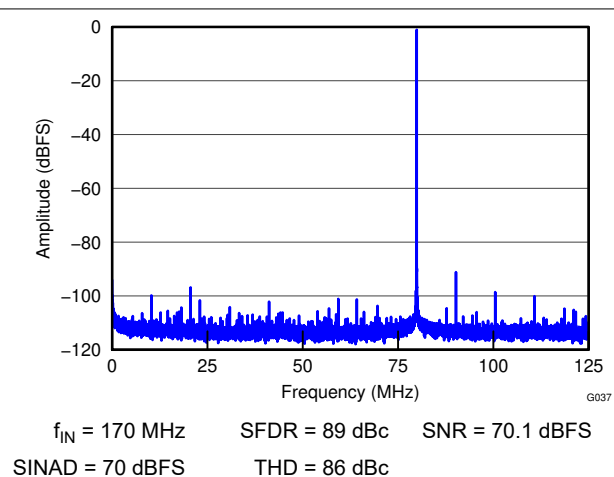
**Figure 8-6. FFT (Default) at 170 MHz****Figure 8-7. FFT with High SNR Mode at 170 MHz**

Figure 8-8 shows SNR versus input frequency with and without these settings.

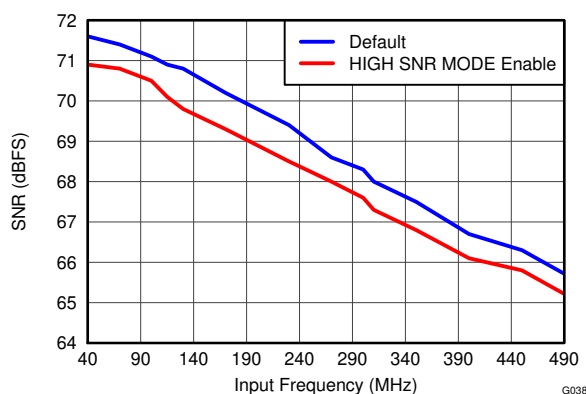


Figure 8-8. SNR vs Input Frequency with High SNR Mode

To obtain best performance, TI recommends keeping termination impedance between INP and INM low (for instance, at 50 Ω differential). This setting helps absorb the kickback noise component of the spectrum-cleaning algorithm. However, when higher termination impedances (such as 100 Ω) are required, shutting down the spectrum-cleaning algorithm by using the HIGH SNR MODE register settings can be helpful.

8.4.4 Input Common Mode

To ensure a low-noise, common-mode reference, the VCM terminal should be filtered with a 0.1- μ F, low-inductance capacitor connected to ground. The VCM terminal is designed to directly bias the ADC inputs (refer to Figure 9-4 to Figure 9-7).

Each ADC input terminal sinks a common-mode current of approximately 1.5 μ A per MSPS of clock frequency. When a differential amplifier is used to drive the ADC (with dc-coupling), ensure that the output common-mode of the amplifier is within the acceptable input common-mode range of the ADC inputs (VCM \pm 25 mV).

8.5 Programming

8.5.1 Serial Interface

The device has a set of internal registers that can be accessed by the serial interface formed by the SEN (serial interface enable), SCLK (serial interface clock), SDATA (serial interface input data), and SDOUT (serial interface readback data) terminals. Serially shifting bits into the device is enabled when SEN is low. Serial data (SDATA) are latched at every SCLK falling edge when SEN is active (low). Serial data are loaded into the register at every 16th SCLK falling edge when SEN is low. When the word length exceeds a multiple of 16 bits, the excess bits are ignored. Data can be loaded in multiples of 16-bit words within a single active SEN pulse. The first eight bits form the register address and the remaining eight bits are the register data. The interface can function with SCLK frequencies from 20 MHz down to very low speeds (of a few hertz) and also with a non-50% SCLK duty cycle.

8.5.1.1 Register Initialization

After power-up, the internal registers must be initialized to the default values. This initialization can be accomplished in one of two ways:

1. Either through a hardware reset by applying a high pulse on the RESET terminal (of widths greater than 10ns), as shown in Figure 6-1; or
2. By applying a software reset. When using the serial interface, set the RESET bit (D1 in register 00h) high. This setting initializes the internal registers to the default values and then self-resets the RESET bit low. In this case, the RESET terminal is kept low.

ADS4449

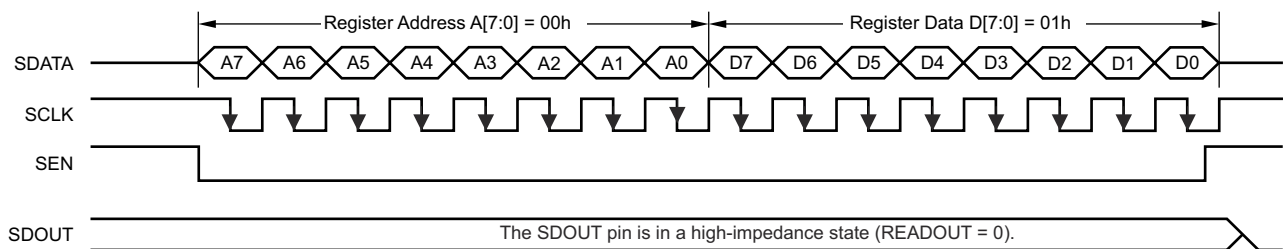
SBAS603B – APRIL 2013 – REVISED NOVEMBER 2020

8.5.1.2 Serial Register Readout

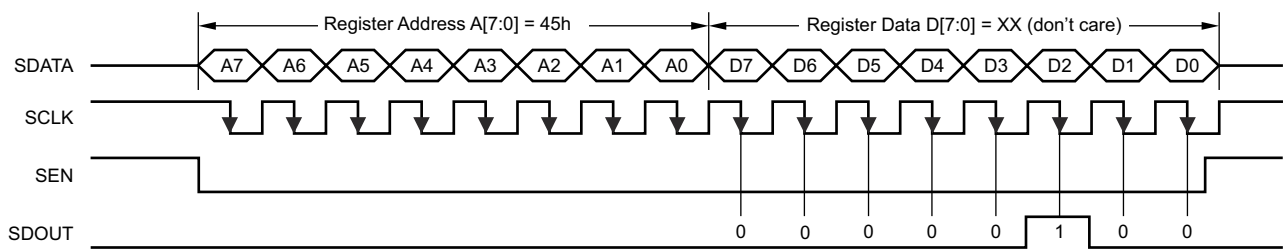
The device includes a mode where the contents of the internal registers can be read back, as shown in [Figure 8-9](#). This readback mode can be useful as a diagnostic check to verify the serial interface communication between the external controller and ADC.

1. Set the READOUT register bit to 1. This setting disables any further writes to the registers except register address 00h.
2. Initiate a serial interface cycle specifying the address of the register (A[7:0]) whose content must be read.
3. The device outputs the contents (D[7:0]) of the selected register on the SDOUT terminal (terminal G10).
4. The external controller can latch the contents at the SCLK falling edge.
5. To enable register writes, reset the READOUT register bit to 0.

Note that the contents of register 00h cannot be read back because the register contains RESET and READOUT bits. When the READOUT bit is disabled, the SDOUT terminal is in a high-impedance state. If serial readout is not used, the SDOUT terminal must not be connected (must float).



a) Enable serial readout (READOUT = 1)



The SDOUT pin functions as a serial readout (READOUT = 1).

b) Read contents of Register 45h. This register is initialized with 04h.

Figure 8-9. Serial Readout Timing Diagram

SDOUT comes out at the SCLK rising edge with an approximate delay (t_{SD_DELAY}) of 8 ns, as shown in [Figure 8-10](#).

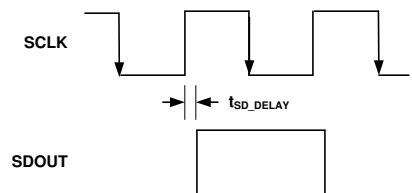


Figure 8-10. Sdout Delay Timing

8.6 Register Maps

Table 8-3 summarizes the device registers.

Table 8-3. Register Map

REGISTER ADDRESS A[7:0] (Hex)	REGISTER DATA								
	D7	D6	D5	D4	D3	D2	D1	D0	
00	0	0	0	0	0	0	RESET	READOUT	
01	LVDS SWING						0	0	
25	DIGITAL GAIN CH B				DIGITAL GAIN BYPASS CH B	TEST PATTERN CH B			
2B	DIGITAL GAIN CH A				DIGITAL GAIN BYPASS CH A	TEST PATTERN CH A			
31	DIGITAL GAIN CH D				DIGITAL GAIN BYPASS CH D	TEST PATTERN CH D			
37	DIGITAL GAIN CH C				DIGITAL GAIN BYPASS CH C	TEST PATTERN CH C			
3D	0	0	OFFSET CORR EN1	0	0	0	0	0	
3F	0	0	CUSTOM PATTERN[13:8]						
40	CUSTOM PATTERN[7:0]								
42	0	0	0	0	DIGITAL ENABLE	0	0	0	
45	0	0	0	DIS OVR ON LSB	SEL OVR	GLOBAL POWER DOWN	0	CONFIG PDN PIN	
4A	0	0	0	0	0	0	0	LSR MODE CH A	
62	0	0	0	0	0	0	0	LSR MODE CH B	
7A	0	0	0	0	0	0	0	LSR MODE CH D	
92	0	0	0	0	0	0	0	LSR MODE CH C	
A9	0	0	0	0	CLOCKOUT DELAY PROG CH AB				
AC	0	CLOCKOUT DELAY PROG CH CD				0	0	ALWAYS WRITE 1	
C3	FAST OVR THRESH PROG								
C4	EN FAST OVR THRESH	0	0	0	0	0	0	0	
CF	0	0	0	0	OFFSET CORR EN2	0	0	0	
D6	ALWAYS WRITE 1	0	0	0	0	0	0	0	
D7	0	0	0	0	ALWAYS WRITE 1	ALWAYS WRITE 1	0	0	
F1	0	0	HIGH FREQ MODE	0	0	ENABLE LVDS SWING PROG			
58	0	0	HIGH SNR MODE CH A	0	0	0	0	0	
59	ALWAYS WRITE 1	0	0	0	0	0	0	0	
70	0	0	HIGH SNR MODE CH B	0	0	0	0	0	
71	ALWAYS WRITE 1	0	0	0	0	0	0	0	
88	0	0	HIGH SNR MODE CH D	0	0	0	0	0	
89	ALWAYS WRITE 1	0	0	0	0	0	0	0	
A0	0	0	HIGH SNR MODE CH C	0	0	0	0	0	
A1	ALWAYS WRITE 1	0	0	0	0	0	0	0	
FE	0	0	0	0	0	PDN CH D	PDN CH C	PDN CH A	PDN CH B

ADS4449

SBAS603B – APRIL 2013 – REVISED NOVEMBER 2020

8.6.1 Register Description**8.6.1.1 Register Address 00h (Default = 00h)**

7	6	5	4	3	2	1	0
0	0	0	0	0	0	RESET	READOUT

Bits 7-2 Always write 0**Bit 1** **RESET: Software reset applied**

This bit resets all internal registers to the default values and self-clears to 0.

Bit 0 **READOUT: Serial readout**

This bit sets the serial readout of the registers.

0 = Serial readout of registers disabled; the SDOOUT terminal is placed in a high-impedance state. (default)

1 = Serial readout enabled; the SDOOUT terminal functions as a serial data readout with CMOS logic levels running from the DRVDD supply.

8.6.1.2 Register Address 01h (Default = 00h)

7	6	5	4	3	2	1	0
LVDS SWING						0	0

Bits 7-2 **LVDS SWING: LVDS swing programmability**

These bits program the LVDS swing only after the ENABLE LVDS SWING PROG bits are set to 11.

000000 = Default LVDS swing; ± 350 mV with an external 100- Ω termination (default)011011 = ± 420 -mV LVDS swing with an external 100- Ω termination110010 = ± 470 -mV LVDS swing with an external 100- Ω termination010100 = ± 560 -mV LVDS swing with an external 100- Ω termination001111 = ± 160 -mV LVDS swing with an external 100- Ω termination**Bits 1-0** Always write 0

8.6.1.3 Register Address 25h (Default = 00h)

7	6	5	4	3	2	1	0
DIGITAL GAIN CH B				DIGITAL GAIN BYPASS CH B	TEST PATTERN CH B		

Bits 7-4

DIGITAL GAIN CH B: Channel B digital gain programmability

These bits set the digital gain programmability from 0 dB to 6 dB in 0.5-dB steps for channel B. Set the DIGITAL ENABLE bit to 1 beforehand to enable this feature.

0000 = 0-dB gain (default)
 0001 = 0.5-dB gain
 0010 = 1-dB gain
 0011 = 1.5-dB gain
 0100 = 2-dB gain
 0101 = 2.5-dB gain
 0110 = 3-dB gain
 0111 = 3.5-dB gain
 1000 = 4-dB gain
 1001 = 4.5-dB gain
 1010 = 5-dB gain
 1011 = 5.5-dB gain
 1100 = 6-dB gain

Bit 3

DIGITAL GAIN BYPASS CH B: Channel B digital gain bypass

0 = Normal operation (default)
 1 = Digital gain feature for channel B is bypassed

Bits 2-0

TEST PATTERN CH B: Channel B test pattern programmability

These bits program the test pattern for channel B.

000 = Normal operation (default)
 001 = Outputs all 0s
 010 = Outputs all 1s
 011 = Outputs toggle pattern

Output data ([D:0]) are an alternating sequence of 01010101010101 and 10101010101010.

100 = Outputs digital ramp

Output data increments by one 14-bit LSB every clock cycle from code 0 to code 16383

101 = Outputs custom pattern

To program a test pattern, use the CUSTOM PATTERN D[13:0] bits of registers 3Fh and 40h.

110 = Unused
 111 = Unused

ADS4449

SBAS603B – APRIL 2013 – REVISED NOVEMBER 2020

8.6.1.4 Register Address 2bh (Default = 00h)

7	6	5	4	3	2	1	0
DIGITAL GAIN CH A				DIGITAL GAIN BYPASS CH A	TEST PATTERN CH A		

Bits 7-4**DIGITAL GAIN CH A: Channel A digital gain programmability**

These bits set the digital gain programmability from 0 dB to 6 dB in 0.5-dB steps for channel A. Set the DIGITAL ENABLE bit to 1 beforehand to enable this feature.

0000 = 0-dB gain (default)
 0001 = 0.5-dB gain
 0010 = 1-dB gain
 0011 = 1.5-dB gain
 0100 = 2-dB gain
 0101 = 2.5-dB gain
 0110 = 3-dB gain
 0111 = 3.5-dB gain
 1000 = 4-dB gain
 1001 = 4.5-dB gain
 1010 = 5-dB gain
 1011 = 5.5-dB gain
 1100 = 6-dB gain

Bit 3**DIGITAL GAIN BYPASS CH A: Channel A digital gain bypass**

0 = Normal operation (default)
 1 = Digital gain feature for channel A is bypassed

Bits 2-0**TEST PATTERN CH A: Channel A test pattern programmability**

These bits program the test pattern for channel A.

000 = Normal operation (default)
 001 = Outputs all 0s
 010 = Outputs all 1s
 011 = Outputs toggle pattern

Output data ([D:0]) are an alternating sequence of *01010101010101* and *10101010101010*.

100 = Outputs digital ramp

Output data increments by one 14-bit LSB every clock cycle from code 0 to code 16383

101 = Outputs custom pattern

To program a test pattern, use the CUSTOM PATTERN D[13:0] bits of registers 3Fh and 40h.

110 = Unused
 111 = Unused

8.6.1.5 Register Address 31h (Default = 00h)

7	6	5	4	3	2	1	0
DIGITAL GAIN CH D				DIGITAL GAIN BYPASS CH D	TEST PATTERN CH D		

Bits 7-4

DIGITAL GAIN CH D: Channel D digital gain programmability

These bits set the digital gain programmability from 0 dB to 6 dB in 0.5-dB steps for channel D. Set the DIGITAL ENABLE bit to 1 beforehand to enable this feature.

0000 = 0-dB gain (default)
 0001 = 0.5-dB gain
 0010 = 1-dB gain
 0011 = 1.5-dB gain
 0100 = 2-dB gain
 0101 = 2.5-dB gain
 0110 = 3-dB gain
 0111 = 3.5-dB gain
 1000 = 4-dB gain
 1001 = 4.5-dB gain
 1010 = 5-dB gain
 1011 = 5.5-dB gain
 1100 = 6-dB gain

Bit 3

DIGITAL GAIN BYPASS CH D: Channel D digital gain bypass

0 = Normal operation (default)
 1 = Digital gain feature for channel A is bypassed

Bits 2-0

TEST PATTERN CH D: Channel D test pattern programmability

These bits program the test pattern for channel D.

000 = Normal operation (default)
 001 = Outputs all 0s
 010 = Outputs all 1s
 011 = Outputs toggle pattern

Output data ([D:0]) are an alternating sequence of 01010101010101 and 10101010101010.

100 = Outputs digital ramp

Output data increments by one 14-bit LSB every clock cycle from code 0 to code 16383

101 = Outputs custom pattern

To program test pattern, use the CUSTOM PATTERN D[13:0] bits of registers 3Fh and 40h.

110 = Unused
 111 = Unused

ADS4449

SBAS603B – APRIL 2013 – REVISED NOVEMBER 2020

8.6.1.6 Register Address 37h (Default = 00h)

7	6	5	4	3	2	1	0
DIGITAL GAIN CH C				DIGITAL GAIN BYPASS CH C	TEST PATTERN CH C		

Bits 7-4**DIGITAL GAIN CH C: Channel C digital gain programmability**

These bits set the digital gain programmability from 0 dB to 6 dB in 0.5-dB steps for channel C. Set the DIGITAL ENABLE bit to 1 beforehand to enable this feature.

0000 = 0-dB gain (default)
 0001 = 0.5-dB gain
 0010 = 1-dB gain
 0011 = 1.5-dB gain
 0100 = 2-dB gain
 0101 = 2.5-dB gain
 0110 = 3-dB gain
 0111 = 3.5-dB gain
 1000 = 4-dB gain
 1001 = 4.5-dB gain
 1010 = 5-dB gain
 1011 = 5.5-dB gain
 1100 = 6-dB gain

Bit 3**DIGITAL GAIN BYPASS CH C: Channel C digital gain bypass**

0 = Normal operation (default)
 1 = Digital gain feature for channel A is bypassed

Bits 2-0**TEST PATTERN CH C: Channel C test pattern programmability**

These bits program the test pattern for channel C.

000 = Normal operation (default)
 001 = Outputs all 0s
 010 = Outputs all 1s
 011 = Outputs toggle pattern

Output data ([D:0]) are an alternating sequence of *01010101010101* and *10101010101010*.

100 = Outputs digital ramp

Output data increments by one 14-bit LSB every clock cycle from code 0 to code 16383

101 = Outputs custom pattern

To program a test pattern, use the CUSTOM PATTERN D[13:0] bits of registers 3Fh and 40h.

110 = Unused
 111 = Unused

8.6.1.7 Register Address 3dh (Default = 00h)

7	6	5	4	3	2	1	0
0	0	OFFSET CORR EN1	0	0	0	0	0

Bits 7-6 Always write 0**Bit 5** **OFFSET CORR EN1: Offset correction setting**

This bit enables the offset correction feature for all four channels after the DIGITAL ENABLE bit is set to '1,' correcting mid-code to 8191. In addition, write the OFFSET CORR EN2 bit (register CFh, value 08h) for proper operation of the offset correction feature.

0 = Offset correction disabled (default)

1 = Offset correction enabled

Bits 4-0 Always write 0**8.6.1.8 Register Address 3fh (Default = 00h)**

7	6	5	4	3	2	1	0
0	0	CUSTOM PATTERN D13	CUSTOM PATTERN D12	CUSTOM PATTERN D11	CUSTOM PATTERN D10	CUSTOM PATTERN D9	CUSTOM PATTERN D8

Bits 7-6 Always write 0**Bits 5-0** **CUSTOM PATTERN D[13:8]**

Set the custom pattern using these bits for all four channels.

8.6.1.9 Register Address 40h (Default = 00h)

7	6	5	4	3	2	1	0
CUSTOM PATTERN D7	CUSTOM PATTERN D6	CUSTOM PATTERN D5	CUSTOM PATTERN D4	CUSTOM PATTERN D3	CUSTOM PATTERN D2	CUSTOM PATTERN D1	CUSTOM PATTERN D0

Bits 7-0 **CUSTOM PATTERN D[7:0]**

Set the custom pattern using these bits for all four channels.

8.6.1.10 Register Address 42h (Default = 00h)

7	6	5	4	3	2	1	0
0	0	0	0	DIGITAL ENABLE	0	0	0

Bits 7-4 Always write 0**Bit 3** **DIGITAL ENABLE**

1 = Digital gain and offset correction features disabled

1 = Digital gain and offset correction features enabled

Bits 2-0 Always write 0

ADS4449

SBAS603B – APRIL 2013 – REVISED NOVEMBER 2020

8.6.1.11 Register Address 45h (Default = 00h)

7	6	5	4	3	2	1	0
0	0	0	DIS OVR ON LSB	SEL OVR	GLOBAL POWER DOWN	0	CONFIG PDN PIN

Bits 7-5**Always write 0****Bit 4****DIS OVR ON LSB**

0 = Effective ADC resolution is 13 bits (the LSB of a 14-bit output is OVR) (default)
 1 = ADC resolution is 14 bits

Bit 3**SEL OVR: OVR selection**

0 = Fast OVR selected (default)
 1 = Normal OVR selected. See the [Section 8.3.1](#) section for details.

Bit 2**GLOBAL POWER DOWN**

0 = Normal operation (default)
 1 = Global power down. All ADC channels, internal references, and output buffers are powered down. Wakeup time from this mode is slow (100 μ s).

Bit 1**Always write 0****Bit 0****CONFIG PDN PIN**

Use this bit to configure PDN terminal.

0 = The PDN terminal functions as a standby terminal. All channels are put in standby. Wake-up time from standby mode is fast (10 μ s). (default)

1 = The PDN terminal functions as a global power-down terminal. All ADC channels, internal references, and output buffers are powered down. Wake-up time from global power mode is slow (100 μ s).

8.6.1.12 Register Address 4ah (Default = 00h)

7	6	5	4	3	2	1	0
0	0	0	0	0	0	0	LSR CH A

Bits 7-1**Always write 0****Bit 0****LSR CH A**

Use this bit to put Channel A into Low Sampling Rate Mode when sampling at a rate below 200MSPS.

8.6.1.13 Register Address 62h (Default = 00h)

7	6	5	4	3	2	1	0
0	0	0	0	0	0	0	LSR CH B

Bits 7-1**Always write 0****Bit 0****LSR CH B: Enables Low Sampling Rate Mode for channel B**

Use this bit to put Channel B into Low Sampling Rate Mode when sampling at a rate below 200MSPS.

8.6.1.14 Register Address 7ah (Default = 00h)

7	6	5	4	3	2	1	0
0	0	0	0	0	0	0	LSR CH D

Bits 7-1**Always write 0****Bit 0****LSR CH D: Enables Low Sampling Rate Mode for channel D**

Use this bit to put Channel D into Low Sampling Rate Mode when sampling at a rate below 200MSPS.

8.6.1.15 Register Address 92h (Default = 00h)

7	6	5	4	3	2	1	0
0	0	0	0	0	0	0	LSR CH C

Bits 7-1**Always write 0****Bit 0****LSR CH C: Enables Low Sampling Rate Mode for channel C**

Use this bit to put Channel C into Low Sampling Rate Mode when sampling at a rate below 200MSPS.

8.6.1.16 Register Address A9h (Default = 00h)

7	6	5	4	3	2	1	0
0	0	0	0	CLOCKOUT DELAY PROG CH AB			

Bits 7-4**Always write 0****Bits 3-0****CLOCKOUT DELAY PROG CH AB**These bits program the clock out delay for channels A and B, see [Table 8-4](#).

ADS4449

SBAS603B – APRIL 2013 – REVISED NOVEMBER 2020

8.6.1.17 Register Address Ach (Default = 00h)

7	6	5	4	3	2	1	0
0	CLOCKOUT DELAY PROG CH CD				0	0	ALWAYS WRITE 1

Bit 7 Always write 0**Bits 6-4** CLOCKOUT DELAY PROG CH CDThese bits program the clock out delay for channels C and D, as shown in [Table 8-4](#).**Bits 2-1** Always write 0**Bit 0** Always write 1This bit is set to 0 by default. User **must** set it to 1 after reset or power-up.**Table 8-4. Clockout Delay Programmability For All Channels**

CLOCKOUT DELAY PROG CHxx	DELAY (ps)
0000 (default)	0 (default)
0001	-30
0010	70
0011	30
0100	-150
0101	-180
0110	-70
0111	-110
1000	270
1001	230
1010	340
1011	300
1100	140
1101	110
1110	200
1111	170

8.6.1.18 Register Address C3h (Default = 00h)

7	6	5	4	3	2	1	0
FAST OVR THRESH PROG							

Bits 7-0 FAST OVR THRESH PROG

The device has a fast OVR mode that indicates an overload condition at the ADC input. The input voltage level at which the overload is detected is referred to as the threshold and is programmable using the FAST OVR THRESH PROG bits.

FAST OVR is triggered seven output clock cycles after the overload condition occurs. To enable the FAST OVR programmability, enable the EN FAST OVR THRESH register bit. The threshold at which fast OVR is triggered is (full-scale × [the decimal value of the FAST OVR THRESH PROG bits] / 255).

After reset, when EN FAST OVR THRESH PROG is set, the default value of the FAST OVR THRESH PROG bits is 230 (decimal).

8.6.1.19 Register Address C4h (Default = 00h)

7	6	5	4	3	2	1	0
EN FAST OVR THRESH	0	0	0	0	0	0	0

Bit 7**EN FAST OVR THRESH**

This bit enables the device to be programmed to select the fast OVR threshold.

Bits 6-0**Always write 0****8.6.1.20 Register Address Cfh (Default = 00h)**

7	6	5	4	3	2	1	0
0	0	0	0	OFFSET CORR EN2	0	0	0

Bits 7-4**Always write 0****Bit 3****OFFSET CORR EN2**

This bit must be set to '1' when the OFFSET CORR EN1 bit is selected.

Bits 2-0**Always write 0****8.6.1.21 Register Address D6h (Default = 00h)**

7	6	5	4	3	2	1	0
ALWAYS WRITE 1	0	0	0	0	0	0	0

Bits 7**Always write 1**This bit is set to 0 by default. User **must** set it to 1 after reset or power-up.**Bits 6-0****Always write 0****8.6.1.22 Register Address D7h (Default = 00h)**

7	6	5	4	3	2	1	0
0	0	0	0	ALWAYS WRITE 1	ALWAYS WRITE 1	0	0

Bits 7-4**Always write 0****Bits 3-2****Always write 1**This bit is set to 0 by default. User **must** set it to 1 after reset or power-up.**Bits 1-0****Always write 0**

ADS4449

SBAS603B – APRIL 2013 – REVISED NOVEMBER 2020

8.6.1.23 Register Address F1h (Default = 00h)

7	6	5	4	3	2	1	0
0	0	HIGH FREQ MODE	0	0	ENABLE LVDS SWING PROG		

Bits 7-6**Always write 0****Bit 5****HIGH FREQ MODE**

0 = Default (default)

1 = Use for input frequencies > 125 MHz

Bits 4-3**Always write 0****Bits 2-0****ENABLE LVDS SWING PROG**

This bit enables the LVDS swing control with the LVDS SWING bits.

00 = LVDS swing control disabled (default)

01 = Do not use

10 = Do not use

11 = LVDS swing control enabled

8.6.1.24 Register Address 58h (Default = 00h)

7	6	5	4	3	2	1	0
0	0	HIGH SNR MODE CH A	0	0	0	0	0

Bits 7-6**Always write 0****Bit 5****HIGH SNR MODE CH A**See the [Section 8.4.3](#) section.**Bits 4-0****Always write 0****8.6.1.25 Register Address 59h (Default = 00h)**

7	6	5	4	3	2	1	0
ALWAYS WRITE 1	0	0	0	0	0	0	0

Bits 7**Always write 1**This bit is set to 0 by default. User **must** set it to 1 after reset or power-up.**Bits 6-0****Always write 0**

8.6.1.26 Register Address 70h (Default = 00h)

7	6	5	4	3	2	1	0
0	0	HIGH SNR MODE CH B	0	0	0	0	0

Bits 7-6 Always write 0

Bit 5 HIGH SNR MODE CH B

See the [Section 8.4.3](#) section.

Bits 4-0 Always write 0

8.6.1.27 Register Address 71h (Default = 00h)

7	6	5	4	3	2	1	0
ALWAYS WRITE 1	0	0	0	0	0	0	0

Bits 7 Always write 1

This bit is set to 0 by default. User **must** set it to 1 after reset or power-up.

Bits 6-0 Always write 0

8.6.1.28 Register Address 88h (Default = 00h)

7	6	5	4	3	2	1	0
0	0	HIGH SNR MODE CH D	0	0	0	0	0

Bits 7-6 Always write 0

Bit 5 HIGH SNR MODE CH D

See the [Section 8.4.3](#) section.

Bits 4-0 Always write 0

8.6.1.29 Register Address 89h (Default = 00h)

7	6	5	4	3	2	1	0
ALWAYS WRITE 1	0	0	0	0	0	0	0

Bits 7 Always write 1

This bit is set to 0 by default. User **must** set it to 1 after reset or power-up.

Bits 6-0 Always write 0

ADS4449

SBAS603B – APRIL 2013 – REVISED NOVEMBER 2020

8.6.1.30 Register Address A0h (Default = 00h)

7	6	5	4	3	2	1	0
0	0	HIGH SNR MODE CH C	0	0	0	0	0

Bits 7-6 Always write 0**Bit 5** HIGH SNR MODE CH CSee the [Section 8.4.3](#) section.**Bits 4-0** Always write 0**8.6.1.31 Register Address A1h (Default = 00h)**

7	6	5	4	3	2	1	0
ALWAYS WRITE 1	0	0	0	0	0	0	0

Bits 7 Always write 1This bit is set to 0 by default. User **must** set it to 1 after reset or power-up.**Bits 6-0** Always write 0**8.6.1.32 Register Address Feh (Default = 00h)**

7	6	5	4	3	2	1	0
0	0	0	0	PDN CH D	PDN CH C	PDN CH A	PDN CH B

Bits 7-4 Always write 0**Bit 3** PDN CH D: Power-down channel D

Channel D is powered down.

Bit 2 PDN CH C: Power-down channel C

Channel C is powered down.

Bit 1 PDN CH B: Power-down channel B

Channel B is powered down.

Bit 0 PDN CH A: Power-down channel A

Channel A is powered down.

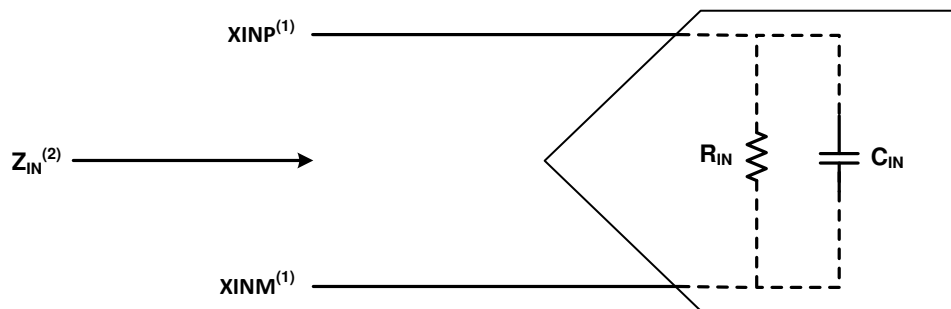
9 Application and Implementation

Note

Information in the following applications sections is not part of the TI component specification, and TI does not warrant its accuracy or completeness. TI's customers are responsible for determining suitability of components for their purposes. Customers should validate and test their design implementation to confirm system functionality.

9.1 Application Information

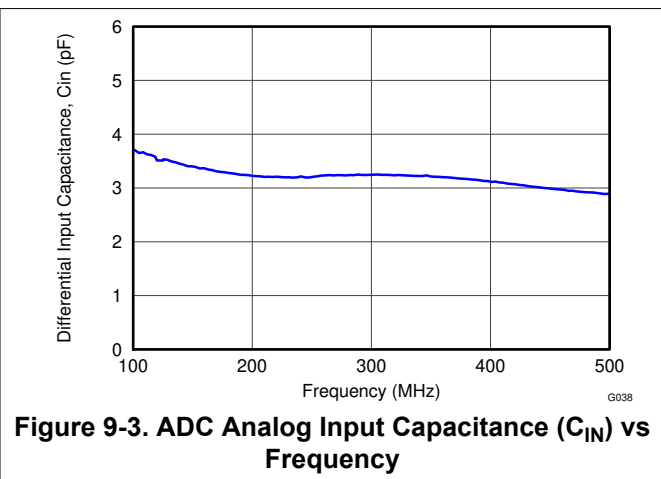
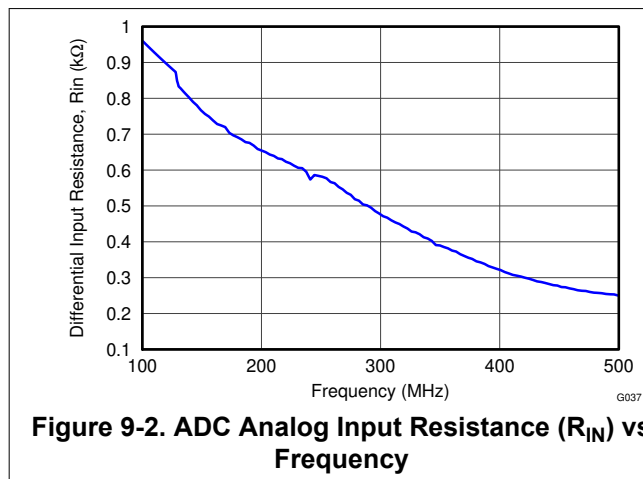
Typical applications involving transformer-coupled circuits are discussed in this section. Transformers (such as ADT1-1WT or WBC1-1) can be used up to 250 MHz to achieve good phase and amplitude balances at ADC inputs. While designing the dc driving circuits, the ADC input impedance must be considered. Figure 9-1 shows that ADC input impedance is represented by parallel combination of resistance and capacitance.



- A. X = A, B, C, or D.
B. $Z_{IN} = R_{IN} \parallel (1 / j\omega C_{IN})$.

Figure 9-1. ADC Equivalent Input Impedance

Figure 9-2 and Figure 9-3 show how input impedance ($Z_{IN} = R_{IN} \parallel C_{IN}$) varies over input frequency.



9.2 Typical Application

Depending on the input frequency, sampling rate, and input amplitude, one of these metrics plays a dominant part in limiting performance. At very high input frequencies, SFDR is determined largely by the device sampling circuit nonlinearity. At low input amplitudes, the quantizer nonlinearity typically limits performance. Glitches are caused by opening and closing the sampling switches. The driving circuit should present a low source impedance to absorb these glitches, otherwise these glitches may limit performance. A low impedance path between the analog input terminals and VCM is required from the common-mode switching currents perspective as well. This impedance can be achieved by using two resistors from each input terminated to the common-

ADS4449

SBAS603B – APRIL 2013 – REVISED NOVEMBER 2020

mode voltage (VCM). The device includes an internal R-C filter from each input to ground. The purpose of this filter is to absorb the sampling glitches inside the device itself. The R-C component values are also optimized to support high input bandwidth (up to 500 MHz). However, using an external R-LC-R filter as a part of drive circuit can improve glitch filtering, thus further resulting in better performance. In addition, the drive circuit may have to be designed to provide a low insertion loss over the desired frequency range and matched source impedance. In doing so, the ADC input impedance (shown in [Figure 9-2](#) and [Figure 9-3](#)) must be considered.

9.2.1 Design Requirements

For optimum performance, the analog inputs must be driven differentially. An optional 5-Ω to 15-Ω resistor in-series with each input pin can be kept to damp out ringing caused by package parasitic. The drive circuit may have to be designed to minimize the impact of kick-back noise generated by sampling switches opening and closing inside the ADC, as well as ensuring low insertion loss over the desired frequency range and matched impedance to the source.

9.2.2 Detailed Design Procedure

Two example driving circuits with a 50-Ω source impedance are shown in [Figure 9-4](#) and [Figure 9-5](#). The driving circuit in [Figure 9-4](#) is optimized for input frequencies in the second Nyquist zone (centered at 185 MHz), whereas the circuit in [Figure 9-5](#) is optimized for input frequencies in third Nyquist zone (centered at 310 MHz).

Note that both drive circuits are terminated by 50 Ω near the ADC side. This termination is accomplished with a 25-Ω resistor from each input to the 1.15-V common-mode (VCM) from the device. This architecture allows the analog inputs to be biased around the required common-mode voltage.

The mismatch in the transformer parasitic capacitance (between the windings) results in degraded even-order harmonic performance. Connecting two identical RF transformers back-to-back helps minimize this mismatch and good performance is obtained for high-frequency input signals.

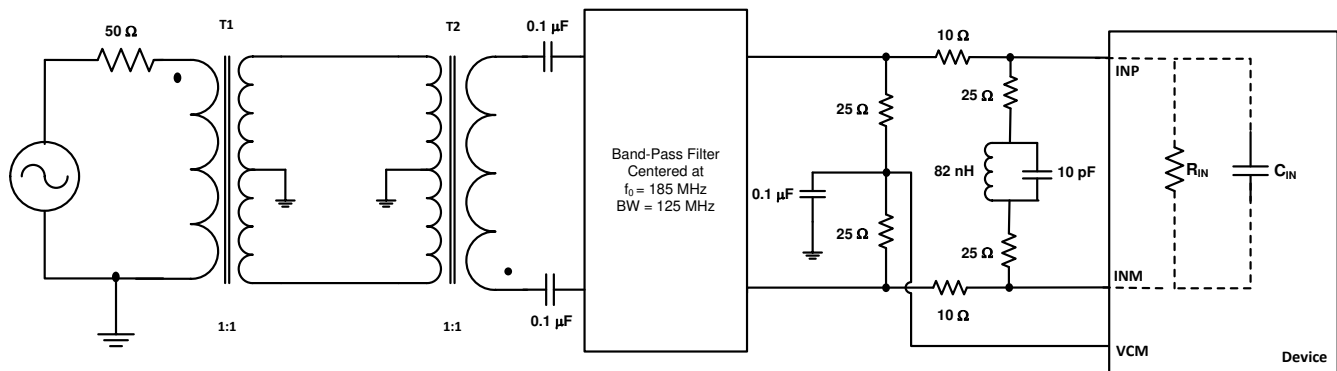


Figure 9-4. Driving Circuit for a 50-Ω Source Impedance and Input Frequencies in the Second Nyquist Zone

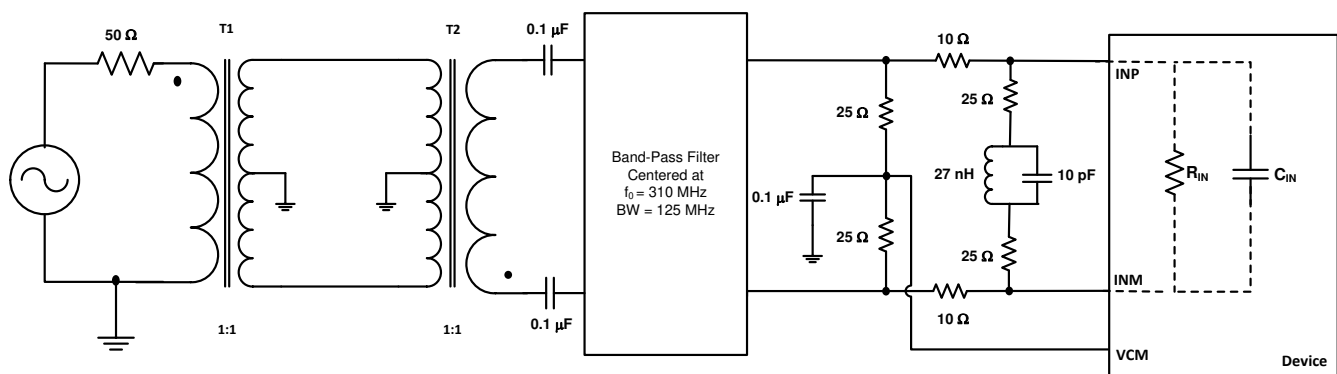


Figure 9-5. Driving Circuit for a 50-Ω Source Impedance and Input Frequencies in the Third Nyquist Zone

TI recommends terminating the drive circuit by a 50- Ω (or lower) impedance near the ADC for best performance. However, in some applications higher impedances be required to terminate the drive circuit. Two example driving circuits with 100- Ω differential termination are shown in Figure 9-6 and Figure 9-7. In these example circuits, the 1:2 transformer (T1) is used to transform the 50- Ω source impedance into a differential 100 Ω at the input of the band-pass filter. In Figure 9-6, the parallel combination of two 68- Ω resistors and one 120-nH inductor and two 100- Ω resistors is used (100 Ω is the effective impedance in pass-band) for better performance.

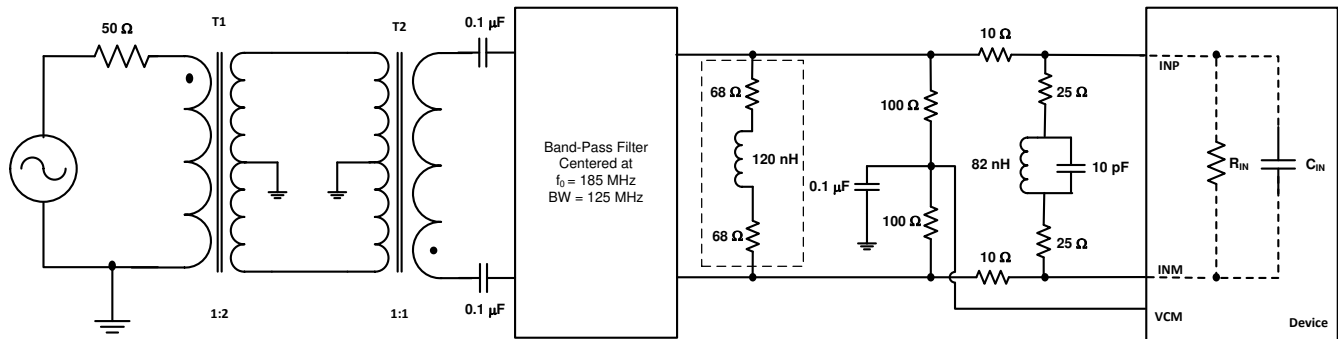


Figure 9-6. Driving Circuit for a 100- Ω Source Impedance and Input Frequencies in the Second Nyquist Zone

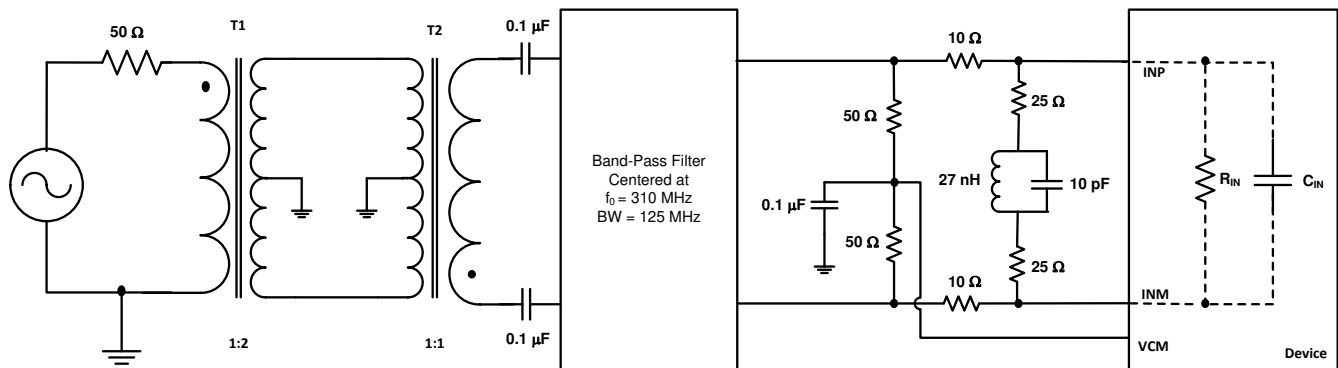


Figure 9-7. Driving Circuit for a 100- Ω Source Impedance and Input Frequencies in the Third Nyquist Zone

9.2.3 Application Curves

Figure 10 and Figure 11 below show performance obtained at 170-MHz and 230-MHz input frequencies respectively using appropriate driving circuit.

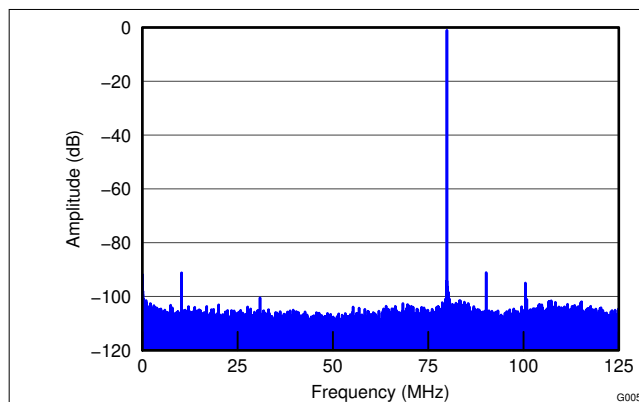


Figure 9-8. FFT For 170-MHz Input Signal

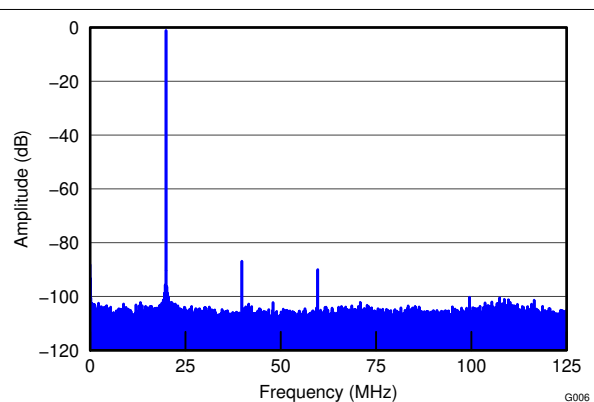


Figure 9-9. FFT For 230MHz Input Signal

ADS4449

SBAS603B – APRIL 2013 – REVISED NOVEMBER 2020

9.2.4 Enabling 14-Bit Resolution

By default after reset, the device outputs 11-bit data on the Dxx13P, Dxx13M and Dxx3P, Dxx3M terminals and OVR information on the Dxx0P, Dxx0M terminals. When the ALWAYS WRITE 1 bits are set, the ADC outputs 13-bit data on the Dxx13P, Dxx13M and Dxx1P, Dxx1M terminals and OVR information on the Dxx0P, Dxx0M terminals. To enable 14-bit resolution, the DIS OVR ON LSB register bit must be set to 1 as indicated in [Table 9-1](#).

Table 9-1. ADC Configuration

ADC TERMINAL NAMES	DATA ON ADC TERMINALS		
	AFTER RESET	ALWAYS WRITE 1 = 1	ALWAYS WRITE 1 = 1 DIS OVR ON LSB = 1
Dxx13	D13	D13	D13
—	—	—	—
Dxx3	D3	D3	D3
Dxx2	Logic 0	D2	D2
Dxx1	Logic 1	D1	D1
Dxx0	OVR	OVR	D0
Comments	11-bit data (D[13:3]) and OVR come on ADC output terminals	13-bit data (D[13:1]) and OVR come on ADC output terminals	14-bit data comes on ADC output terminals

9.2.5 Analog Input

The analog input consists of a switched-capacitor-based differential sample-and-hold architecture. This differential topology results in very good ac performance even for high input frequencies at high sampling rates.

The INP and INM terminals must be externally biased around a common-mode voltage of 1.15 V, available on the VCM terminal. For a full-scale differential input, each input terminal (INP, INM) must swing symmetrically between $V_{CM} + 0.5\text{ V}$ and $V_{CM} - 0.5\text{ V}$, resulting in a $2\text{-}V_{PP}$ differential input swing.

The input sampling circuit has a high 3-dB bandwidth that extends up to 500 MHz when a 50- Ω source drives the ADC analog inputs.

9.2.6 Drive Circuit Requirements

This configuration improves the common-mode noise immunity and even-order harmonic rejection. A 5- Ω to 15- Ω resistor in series with each input terminal is recommended to damp out ringing caused by package parasitics.

Glitches are caused by opening and closing the sampling switches. The driving circuit should present a low source impedance to absorb these glitches, otherwise these glitches may limit performance. A low impedance path between the analog input terminals and VCM is required from the common-mode switching currents perspective as well. This impedance can be achieved by using two resistors from each input terminated to the common-mode voltage (VCM).

The device includes an internal R-C filter from each input to ground. The purpose of this filter is to absorb the sampling glitches inside the device itself. The R-C component values are also optimized to support high input bandwidth (up to 500 MHz). However, using an external R-LC-R filter (refer to [Figure 9-4](#), [Figure 9-5](#), [Figure 9-6](#), [Figure 9-7](#), and [Figure 9-10](#)) improves glitch filtering, thus further resulting in better performance.

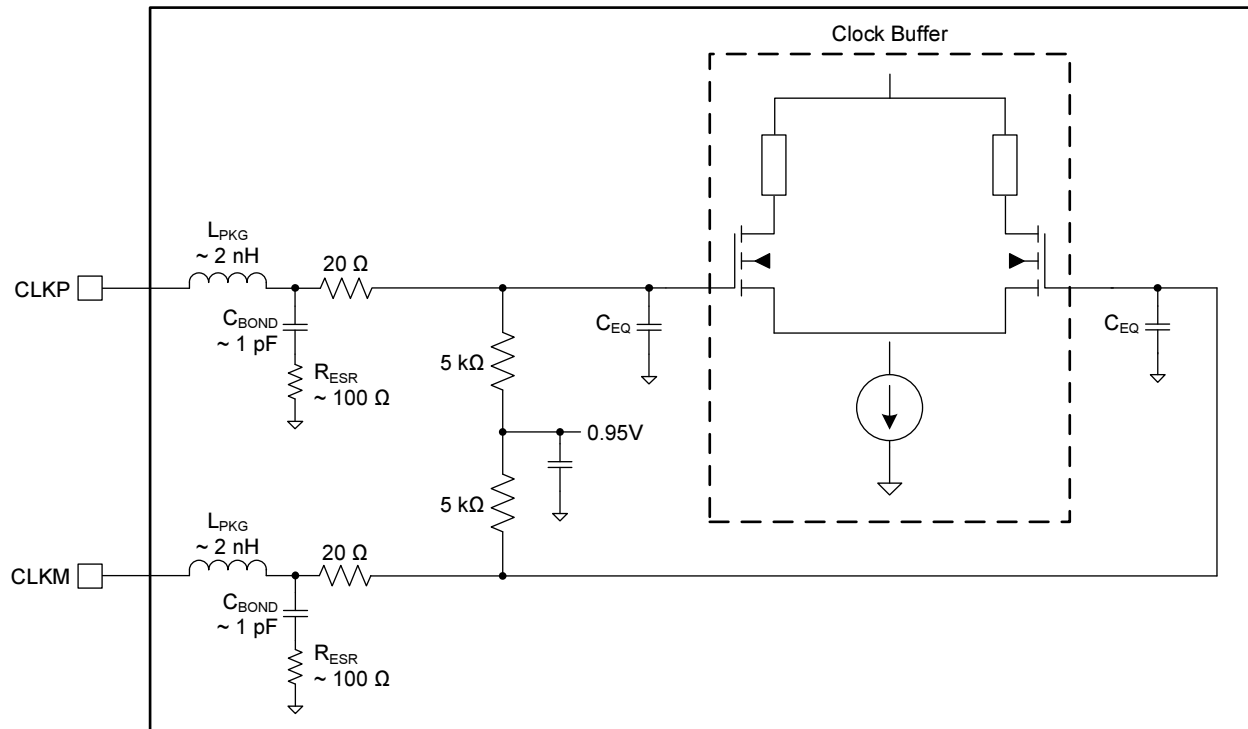
In addition, the drive circuit may have to be designed to provide a low insertion loss over the desired frequency range and matched source impedance. In doing so, the ADC input impedance must be considered. [Figure 9-1](#), [Figure 9-2](#), and [Figure 9-3](#) show the impedance ($Z_{IN} = R_{IN} \parallel C_{IN}$) at the ADC input terminals.

Spurious-free dynamic range (SFDR) performance can be limited because of several reasons (such as the effect of sampling glitches, sampling circuit nonlinearity, and quantizer nonlinearity that follows the sampling circuit). Depending on the input frequency, sampling rate, and input amplitude, one of these metrics plays a dominant part in limiting performance. At very high input frequencies, SFDR is determined largely by the device sampling circuit nonlinearity. At low input amplitudes, the quantizer nonlinearity typically limits performance.

9.2.7 Clock Input

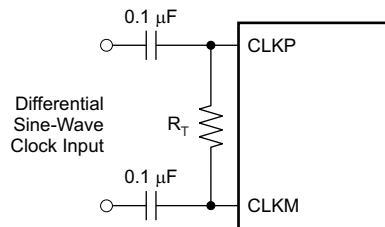
The device clock inputs can be driven differentially with a sine, LVPECL, or LVDS source with little or no difference in performance between them. The common-mode voltage of the clock inputs is set to 0.95 V using internal 5-k Ω resistors, as shown in Figure 9-10. This setting allows the use of transformer-coupled drive circuits for sine-wave clock or ac-coupling for LVPECL, LVDS, and LVCMOS clock sources (see Figure 9-11, Figure 9-12, and Figure 9-13).

For best performance, the clock inputs must be driven differentially, thereby reducing susceptibility to common-mode noise. TI recommends keeping the differential voltage between clock inputs less than 1.8 V_{PP} to obtain best performance. A clock source with very low jitter is recommended for high input frequency sampling. Band-pass filtering of the clock source can help reduce the effects of jitter. With a non-50% duty cycle clock input, performance does not change.



NOTE: C_{EQ} is 1 pF to 3 pF and is the equivalent input capacitance of the clock buffer.

Figure 9-10. Internal Clock Buffer

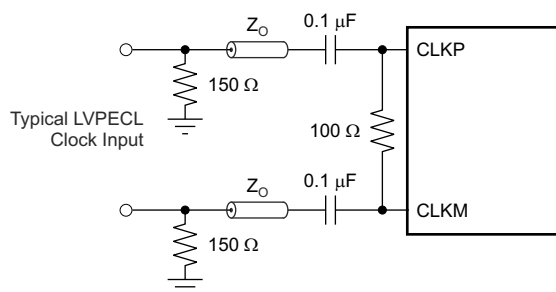
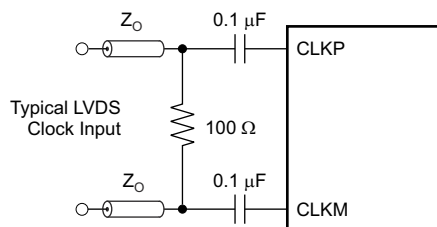
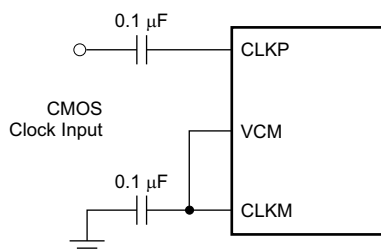


A. R_T is the termination resistor (optional).

Figure 9-11. Differential Sine-Wave Clock Driving Circuit

ADS4449

SBAS603B – APRIL 2013 – REVISED NOVEMBER 2020

**Figure 9-12. LVPECL Clock Driving Circuit****Figure 9-13. LVDS Clock Driving Circuit****Figure 9-14. Typical LVCMOS Clock Driving Circuit****10 Power Supply Recommendations**

The device requires a 1.8-V nominal supply for AVDD and DVDD. There are no specific sequence power-supply requirements during device power-up. AVDD and DVDD can power up in any order.

11 Layout

11.1 Layout Guidelines

The ADS4449 EVM layout can be used as a reference layout to obtain the best performance. A layout diagram of the EVM top layer is provided in [Figure 11-1](#). Some important points to remember during laying out the board are:

- Analog inputs are located on opposite sides of the device pin out to ensure minimum crosstalk on the package level. To minimize crosstalk onboard, the analog inputs should exit the pin out in opposite directions, as shown in the reference layout of Figure 66 as much as possible.
- In the device pin out, the sampling clock is located on a side perpendicular to the analog inputs in order to minimize coupling between them. This configuration is also maintained on the reference layout of Figure 66 as much as possible.
- Digital outputs should be kept away from the analog inputs. When these digital outputs exit the pin out, the digital output traces should not be kept parallel to the analog input traces because this configuration may result in coupling from digital outputs to analog inputs and degrade performance. All digital output traces to the receiver [such as a field-programmable gate array (FPGA) or an application-specific integrated circuit (ASIC)] should be matched in length to avoid skew among outputs.
- At each power-supply pin (AVDD and DVDD), a 0.1- μF decoupling capacitor should be kept close to the device. A separate decoupling capacitor group consisting of a parallel combination of 10- μF , 1- μF , and 0.1- μF capacitors can be kept close to the supply source.

11.2 Layout Example

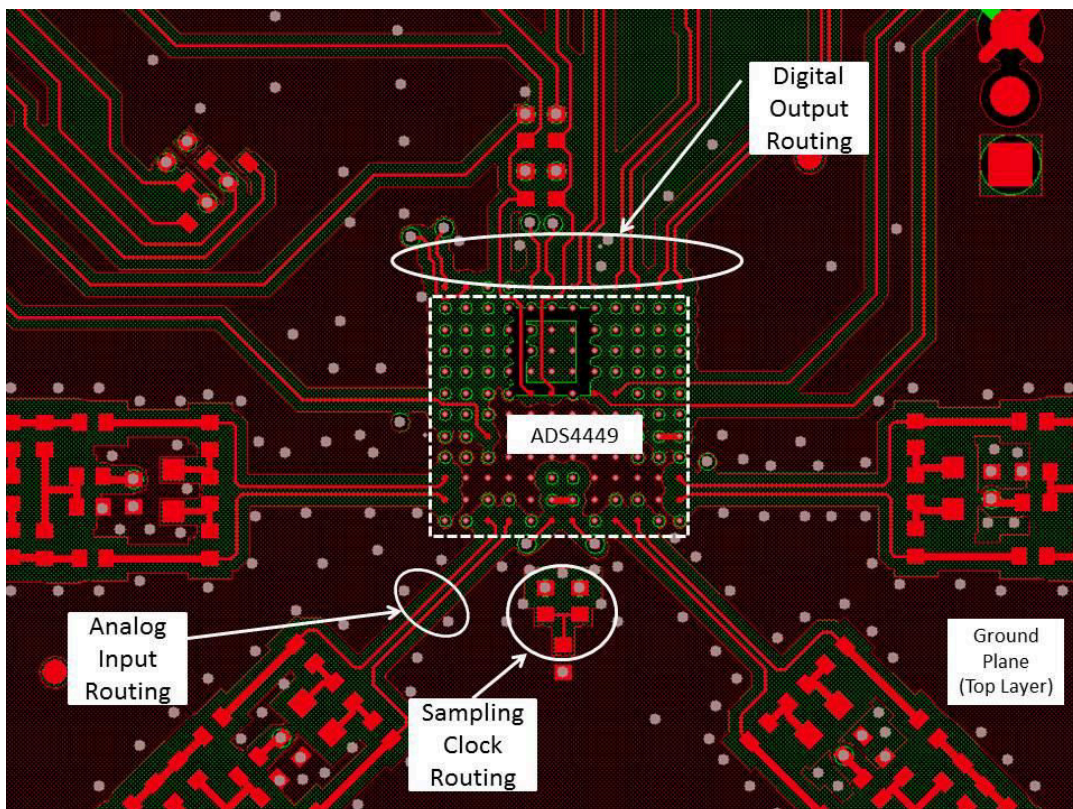


Figure 11-1. ADS4449 Layout

12 Device and Documentation Support

12.1 Device Nomenclature

Analog Bandwidth	The analog input frequency at which the power of the fundamental is reduced by 3 dB with respect to the low-frequency value.
Aperture Delay	The delay in time between the rising edge of the input sampling clock and the actual time at which the sampling occurs. This delay is different across channels. The maximum variation is specified as an aperture delay variation (channel-to-channel).
Aperture Uncertainty (Jitter)	The sample-to-sample variation in aperture delay.
Clock Pulse Width and Duty Cycle	The duty cycle of a clock signal is the ratio of the time the clock signal remains at a logic high (clock pulse width) to the period of the clock signal. Duty cycle is typically expressed as a percentage. A perfect differential sine-wave clock results in a 50% duty cycle.
Maximum Conversion Rate	The maximum sampling rate at which specified operation is given. All parametric testing is performed at this sampling rate, unless otherwise noted.
Minimum Conversion Rate	The minimum sampling rate at which the ADC functions.
Differential Nonlinearity (DNL)	An ideal ADC exhibits code transitions at analog input values spaced exactly 1 LSB apart. DNL is the deviation of any single step from this ideal value, measured in units of LSBs.
Integral Nonlinearity (INL)	INL is the deviation of the ADC transfer function from a best-fit line determined by a least-squares curve fit of that transfer function, measured in units of LSBs.
Gain Error	Gain error is the deviation of the ADC actual input full-scale range from the ideal value. Gain error is given as a percentage of the ideal input full-scale range. Gain error has two components: error as a result of reference inaccuracy and error as a result of the channel. Both errors are specified independently as E_{GREF} and E_{GCHAN} . To a first-order approximation, the total gain error of E_{TOTAL} is approximately $E_{GREF} + E_{GCHAN}$. For example, if $E_{TOTAL} = \pm 0.5\%$, the full-scale input varies from $(1 - 0.5 / 100) \times f_{S\ ideal}$ to $(1 + 0.5 / 100) \times f_{S\ ideal}$.
Offset Error	Offset error is the difference, given in number of LSBs, between the ADC actual average idle channel output code and the ideal average idle channel output code. This quantity is often mapped into millivolts.
Temperature Drift	The temperature drift coefficient (with respect to gain error and offset error) specifies the change per degree Celsius of the parameter from T_{MIN} to T_{MAX} . The coefficient is calculated by dividing the maximum deviation of the parameter across the T_{MIN} to T_{MAX} range by the difference of $T_{MAX} - T_{MIN}$.
Signal-to-Noise Ratio (SNR)	SNR is the ratio of the power of the fundamental (P_S) to the noise floor power (P_N), excluding the power at dc and the first nine harmonics.

$$SNR = 10 \log_{10} \frac{P_S}{P_N} \quad (1)$$

SNR is either given in units of dBc (dB to carrier) when the absolute power of the fundamental is used as the reference, or dBFS (dB to full-scale) when the power of the fundamental is extrapolated to the converter full-scale range.

**Signal-to-Noise
and Distortion
(SINAD)**

SINAD is the ratio of the power of the fundamental (P_S) to the power of all other spectral components, including noise (P_N) and distortion (P_D) but excluding dc.

$$\text{SINAD} = 10\text{Log}^{10} \frac{P_S}{P_N + P_D} \quad (2)$$

SINAD is either given in units of dBc (dB to carrier) when the absolute power of the fundamental is used as the reference, or dBFS (dB to full-scale) when the power of the fundamental is extrapolated to the converter full-scale range.

12.2 Documentation Support

12.2.1 Related Documentation

For related documentation see the following:

- *ADS4449 User Guide*, [SLAU485](#)
- *Design Considerations for Avoiding Timing Errors during High-Speed ADC, LVDS Data Interface with FPGA*, [SLAA592](#)
- *Why Oversample when Undersampling can do the Job?*, [SLAA594](#)

12.3 Receiving Notification of Documentation Updates

To receive notification of documentation updates, navigate to the device product folder on [ti.com](#). Click on *Subscribe to updates* to register and receive a weekly digest of any product information that has changed. For change details, review the revision history included in any revised document.

12.4 Support Resources

[TI E2E™ support forums](#) are an engineer's go-to source for fast, verified answers and design help — straight from the experts. Search existing answers or ask your own question to get the quick design help you need.

Linked content is provided "AS IS" by the respective contributors. They do not constitute TI specifications and do not necessarily reflect TI's views; see TI's [Terms of Use](#).

12.5 Trademarks

TI E2E™ is a trademark of Texas Instruments.
All trademarks are the property of their respective owners.

12.6 Electrostatic Discharge Caution



This integrated circuit can be damaged by ESD. Texas Instruments recommends that all integrated circuits be handled with appropriate precautions. Failure to observe proper handling and installation procedures can cause damage.

ESD damage can range from subtle performance degradation to complete device failure. Precision integrated circuits may be more susceptible to damage because very small parametric changes could cause the device not to meet its published specifications.

12.7 Glossary

[TI Glossary](#) This glossary lists and explains terms, acronyms, and definitions.

Mechanical, Packaging, and Orderable Information

The following pages include mechanical, packaging, and orderable information. This information is the most current data available for the designated devices. This data is subject to change without notice and revision of this document. For browser-based versions of this data sheet, refer to the left-hand navigation.

PACKAGING INFORMATION

Orderable part number	Status (1)	Material type (2)	Package Pins	Package qty Carrier	RoHS (3)	Lead finish/ Ball material (4)	MSL rating/ Peak reflow (5)	Op temp (°C)	Part marking (6)
ADS4449IZCR	Active	Production	NFBGA (ZCR) 144	184 JEDEC TRAY (10+1)	Yes	SNAGCU	Level-3-260C-168 HR	-40 to 85	ADS4449I
ADS4449IZCR.A	Active	Production	NFBGA (ZCR) 144	184 JEDEC TRAY (10+1)	Yes	SNAGCU	Level-3-260C-168 HR	-40 to 85	ADS4449I
ADS4449IZCRR	Active	Production	NFBGA (ZCR) 144	1000 LARGE T&R	Yes	SNAGCU	Level-3-260C-168 HR	-40 to 85	ADS4449I
ADS4449IZCRR.A	Active	Production	NFBGA (ZCR) 144	1000 LARGE T&R	Yes	SNAGCU	Level-3-260C-168 HR	-40 to 85	ADS4449I

(1) **Status:** For more details on status, see our [product life cycle](#).

(2) **Material type:** When designated, preproduction parts are prototypes/experimental devices, and are not yet approved or released for full production. Testing and final process, including without limitation quality assurance, reliability performance testing, and/or process qualification, may not yet be complete, and this item is subject to further changes or possible discontinuation. If available for ordering, purchases will be subject to an additional waiver at checkout, and are intended for early internal evaluation purposes only. These items are sold without warranties of any kind.

(3) **RoHS values:** Yes, No, RoHS Exempt. See the [TI RoHS Statement](#) for additional information and value definition.

(4) **Lead finish/Ball material:** Parts may have multiple material finish options. Finish options are separated by a vertical ruled line. Lead finish/Ball material values may wrap to two lines if the finish value exceeds the maximum column width.

(5) **MSL rating/Peak reflow:** The moisture sensitivity level ratings and peak solder (reflow) temperatures. In the event that a part has multiple moisture sensitivity ratings, only the lowest level per JEDEC standards is shown. Refer to the shipping label for the actual reflow temperature that will be used to mount the part to the printed circuit board.

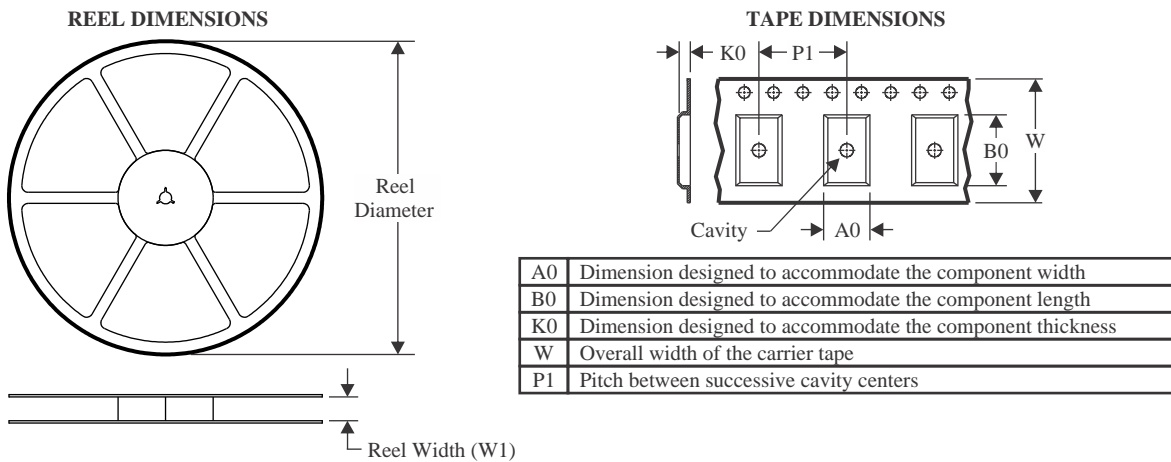
(6) **Part marking:** There may be an additional marking, which relates to the logo, the lot trace code information, or the environmental category of the part.

Multiple part markings will be inside parentheses. Only one part marking contained in parentheses and separated by a "-" will appear on a part. If a line is indented then it is a continuation of the previous line and the two combined represent the entire part marking for that device.

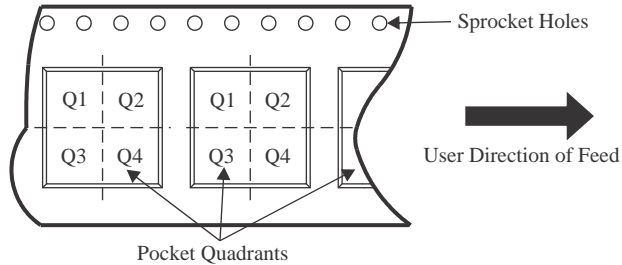
Important Information and Disclaimer: The information provided on this page represents TI's knowledge and belief as of the date that it is provided. TI bases its knowledge and belief on information provided by third parties, and makes no representation or warranty as to the accuracy of such information. Efforts are underway to better integrate information from third parties. TI has taken and continues to take reasonable steps to provide representative and accurate information but may not have conducted destructive testing or chemical analysis on incoming materials and chemicals. TI and TI suppliers consider certain information to be proprietary, and thus CAS numbers and other limited information may not be available for release.

In no event shall TI's liability arising out of such information exceed the total purchase price of the TI part(s) at issue in this document sold by TI to Customer on an annual basis.

TAPE AND REEL INFORMATION



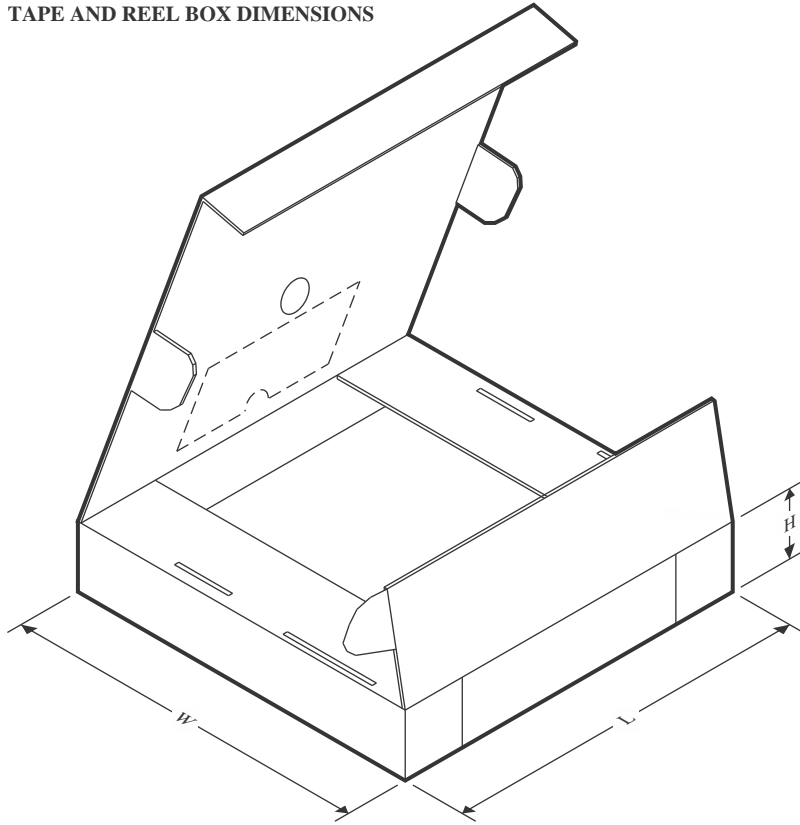
QUADRANT ASSIGNMENTS FOR PIN 1 ORIENTATION IN TAPE



*All dimensions are nominal

Device	Package Type	Package Drawing	Pins	SPQ	Reel Diameter (mm)	Reel Width W1 (mm)	A0 (mm)	B0 (mm)	K0 (mm)	P1 (mm)	W (mm)	Pin1 Quadrant
ADS4449IZCRR	NFBGA	ZCR	144	1000	330.0	24.4	10.25	10.25	2.25	16.0	24.0	Q1

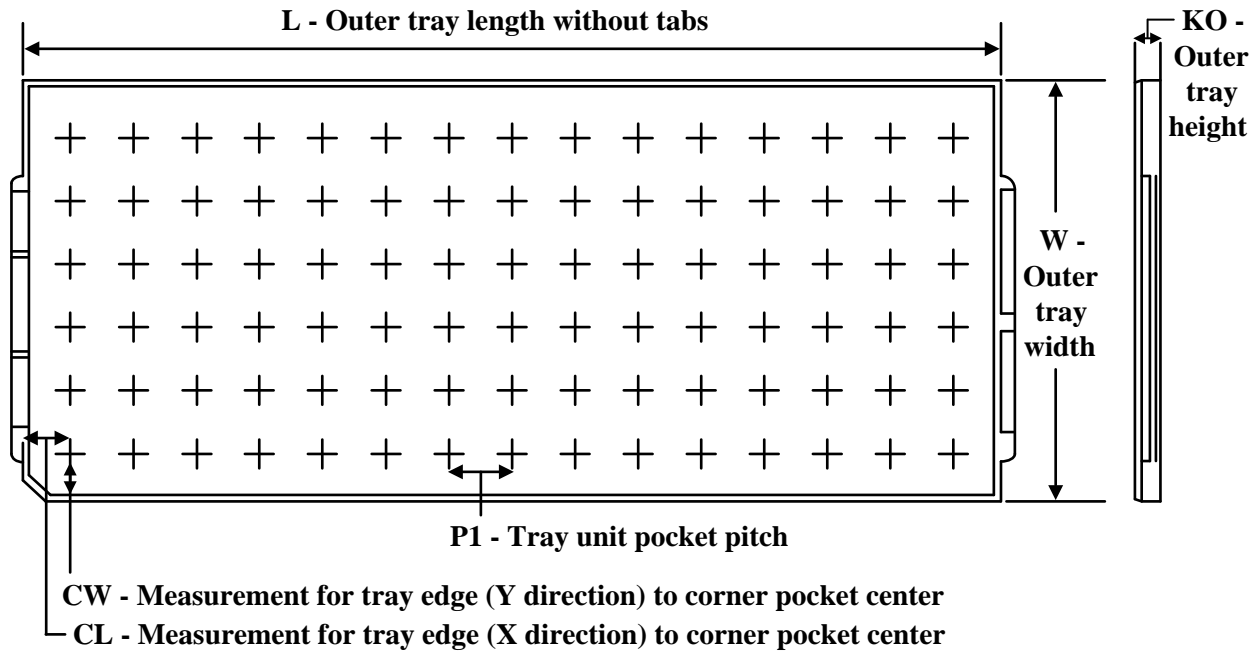
TAPE AND REEL BOX DIMENSIONS



*All dimensions are nominal

Device	Package Type	Package Drawing	Pins	SPQ	Length (mm)	Width (mm)	Height (mm)
ADS4449IZCRR	NFBGA	ZCR	144	1000	350.0	350.0	43.0

TRAY



Chamfer on Tray corner indicates Pin 1 orientation of packed units.

*All dimensions are nominal

Device	Package Name	Package Type	Pins	SPQ	Unit array matrix	Max temperature (°C)	L (mm)	W (mm)	K0 (µm)	P1 (mm)	CL (mm)	CW (mm)
ADS4449IZCR	ZCR	NFBGA	144	184	8 x 23	150	315	135.9	7620	13.4	10.1	19.65
ADS4449IZCR.A	ZCR	NFBGA	144	184	8 x 23	150	315	135.9	7620	13.4	10.1	19.65

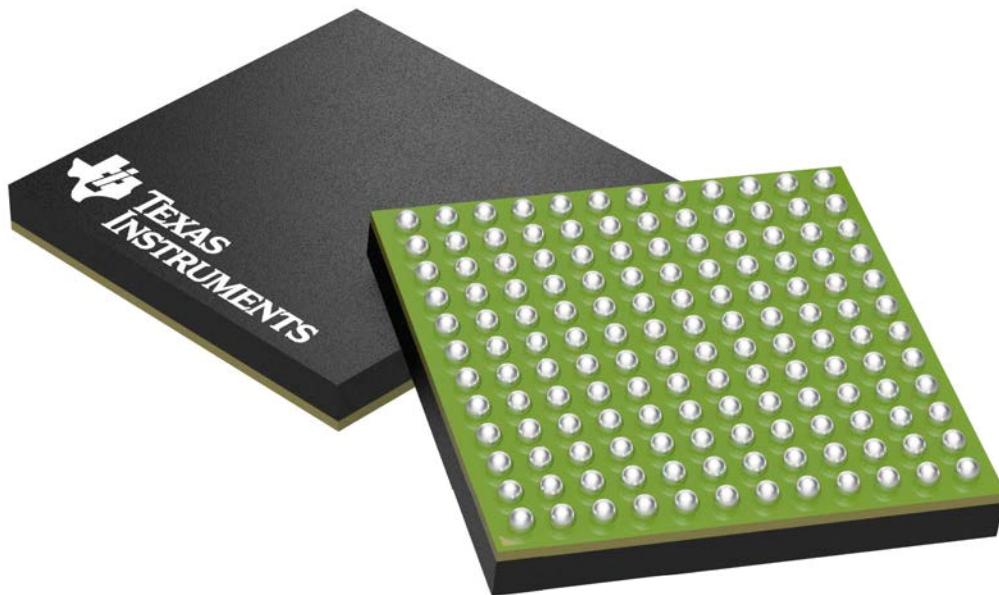
GENERIC PACKAGE VIEW

ZCR 144

NFBGA - 1.5 mm max height

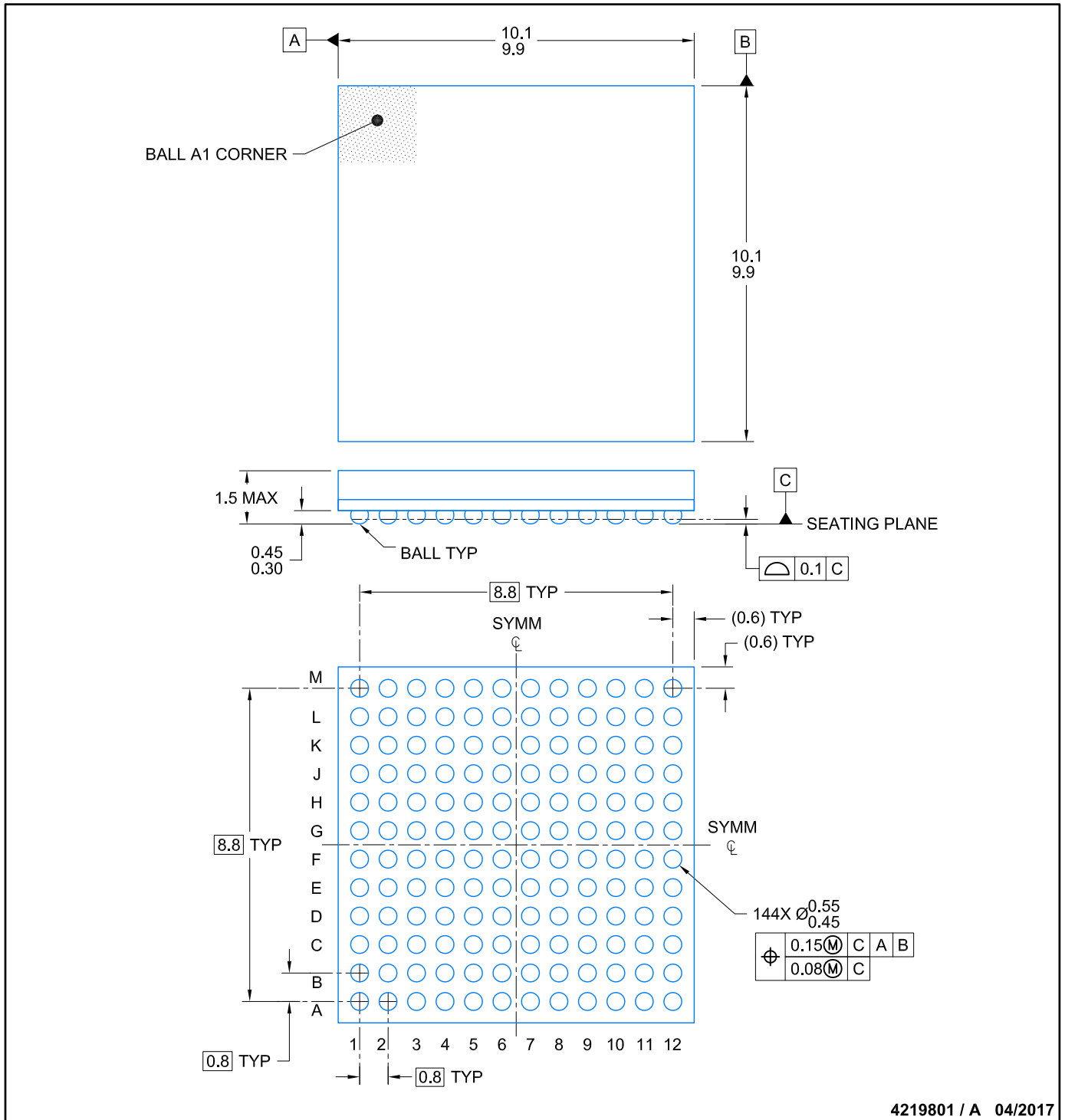
10 x 10 mm, 0.8 mm pitch

PLASTIC BALL GRID ARRAY



Images above are just a representation of the package family, actual package may vary.
Refer to the product data sheet for package details.

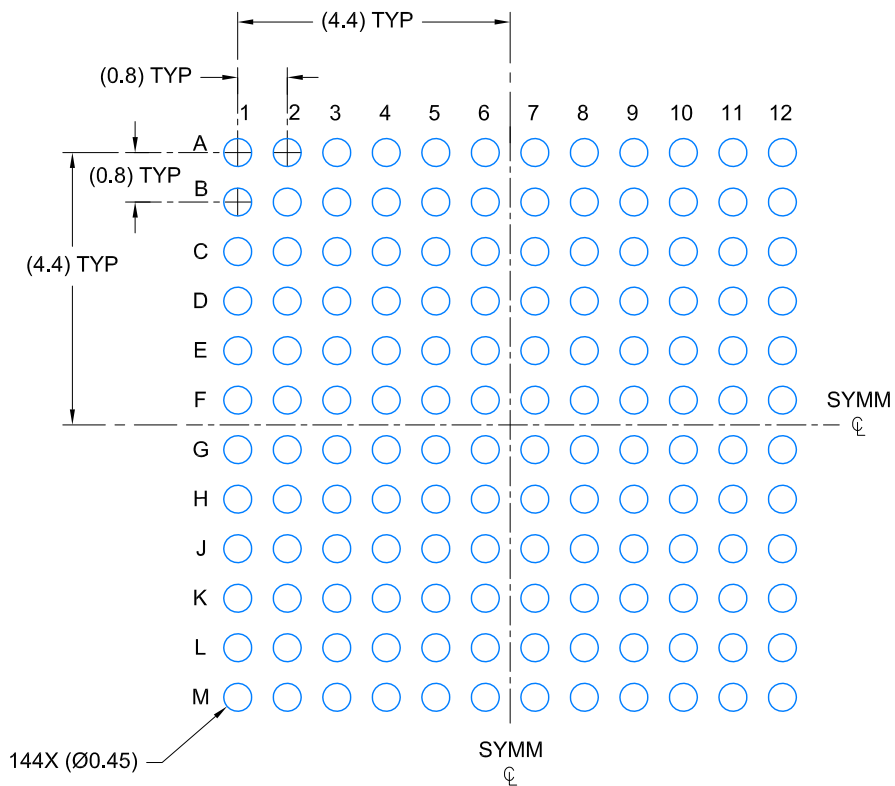
4210272/D



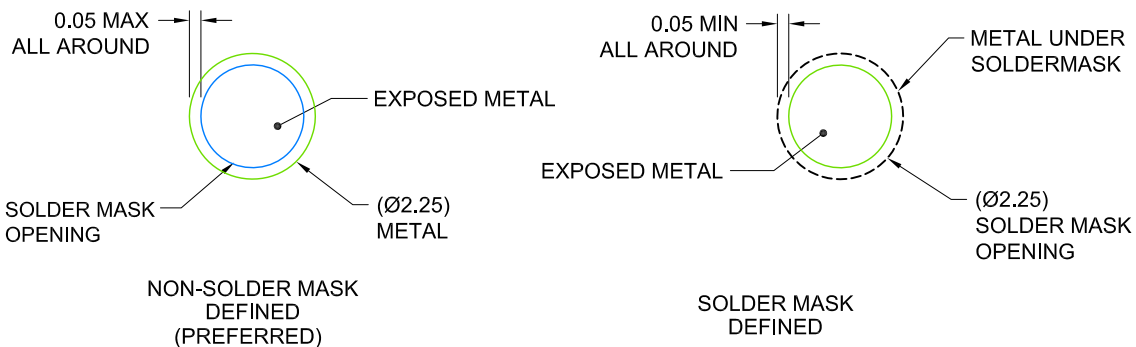
4219801 / A 04/2017

NOTES:

1. All linear dimensions are in millimeters. Any dimensions in parenthesis are for reference only. Dimensioning and tolerancing per ASME Y14.5M.
2. This drawing is subject to change without notice.



LAND PATTERN EXAMPLE
EXPOSED METAL SHOWN
SCALE:8X



SOLDER MASK DETAILS
NOT TO SCALE

4219801 / A 04/2017

NOTES: (continued)

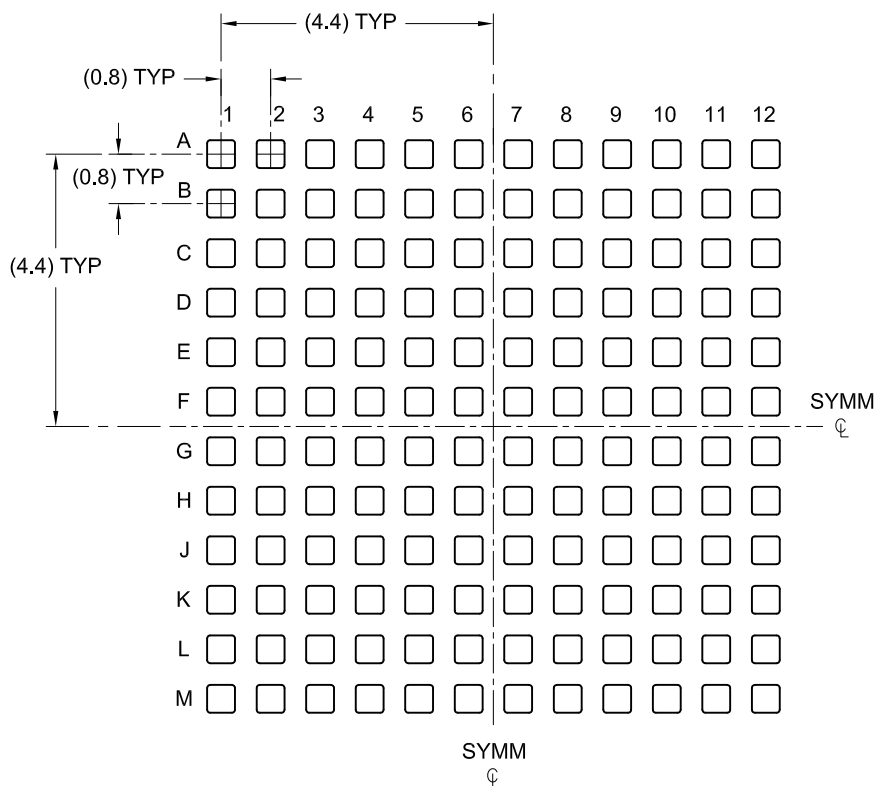
- Final dimensions may vary due to manufacturing tolerance considerations and also routing constraints. Refer to Texas Instruments Literature number SPRAA99 (www.ti.com/lit/spraa9).

EXAMPLE STENCIL DESIGN

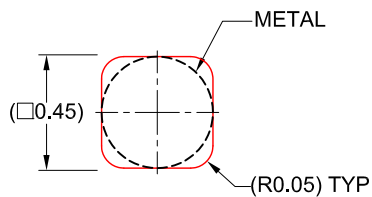
ZCR0144A

NFBGA - 1.5 mm max height

PLASTIC BALL GRID ARRAY



SOLDER PASTE EXAMPLE
 BASED ON 0.15 mm THICK STENCIL
 SCALE: 8X



DETAIL
 SCALE:32X

4219801 / A 04/2017

NOTES: (continued)

- 4. Laser cutting apertures with trapezoidal walls and rounded corners may offer better paste release.

IMPORTANT NOTICE AND DISCLAIMER

TI PROVIDES TECHNICAL AND RELIABILITY DATA (INCLUDING DATASHEETS), DESIGN RESOURCES (INCLUDING REFERENCE DESIGNS), APPLICATION OR OTHER DESIGN ADVICE, WEB TOOLS, SAFETY INFORMATION, AND OTHER RESOURCES "AS IS" AND WITH ALL FAULTS, AND DISCLAIMS ALL WARRANTIES, EXPRESS AND IMPLIED, INCLUDING WITHOUT LIMITATION ANY IMPLIED WARRANTIES OF MERCHANTABILITY, FITNESS FOR A PARTICULAR PURPOSE OR NON-INFRINGEMENT OF THIRD PARTY INTELLECTUAL PROPERTY RIGHTS.

These resources are intended for skilled developers designing with TI products. You are solely responsible for (1) selecting the appropriate TI products for your application, (2) designing, validating and testing your application, and (3) ensuring your application meets applicable standards, and any other safety, security, regulatory or other requirements.

These resources are subject to change without notice. TI grants you permission to use these resources only for development of an application that uses the TI products described in the resource. Other reproduction and display of these resources is prohibited. No license is granted to any other TI intellectual property right or to any third party intellectual property right. TI disclaims responsibility for, and you fully indemnify TI and its representatives against any claims, damages, costs, losses, and liabilities arising out of your use of these resources.

TI's products are provided subject to [TI's Terms of Sale](#), [TI's General Quality Guidelines](#), or other applicable terms available either on [ti.com](#) or provided in conjunction with such TI products. TI's provision of these resources does not expand or otherwise alter TI's applicable warranties or warranty disclaimers for TI products. Unless TI explicitly designates a product as custom or customer-specified, TI products are standard, catalog, general purpose devices.

TI objects to and rejects any additional or different terms you may propose.

Copyright © 2025, Texas Instruments Incorporated

Last updated 10/2025

OUR CERTIFICATE

DiGi provide top-quality products and perfect service for customer worldwide through standardization, technological innovation and continuous improvement. DiGi through third-party certification, we stricly control the quality of products and services. Welcome your RFQ to

Email: Info@DiGi-Electronics.com



Tel: +00 852-30501935

RFQ Email: Info@DiGi-Electronics.com

DiGi is a global authorized distributor of electronic components.