

ADS8317IDGKR Datasheet

www.digi-electronics.com



ADS8317IDGKR

<https://www.DiGi-Electronics.com>

DiGi Electronics Part Number	ADS8317IDGKR-DG
Manufacturer	Texas Instruments
Manufacturer Product Number	ADS8317IDGKR
Description	IC ADC 16BIT SAR 8VSSOP
Detailed Description	16 Bit Analog to Digital Converter 1 Input 1 SAR 8-V SSOP



Tel: +00 852-30501935

RFQ Email: Info@DiGi-Electronics.com

DiGi is a global authorized distributor of electronic components.

Purchase and inquiry

Manufacturer Product Number:

ADS8317IDGKR

Series:

microPOWER™

Number of Bits:

16

Number of Inputs:

1

Data Interface:

SPI

Ratio - S/H:ADC:

1:1

Architecture:

SAR

Voltage - Supply, Analog:

2.7V ~ 3.6V, 5V

Features:

-

Package / Case:

8-TSSOP, 8-MSOP (0.118", 3.00mm Width)

Mounting Type:

Surface Mount

Manufacturer:

Texas Instruments

Product Status:

Active

Sampling Rate (Per Second):

250k

Input Type:

Differential

Configuration:

S/H-ADC

Number of A/D Converters:

1

Reference Type:

External

Voltage - Supply, Digital:

2.7V ~ 3.6V, 5V

Operating Temperature:

-40°C ~ 85°C

Supplier Device Package:

8-VSSOP

Base Product Number:

ADS8317

Environmental & Export classification

RoHS Status:

ROHS3 Compliant

REACH Status:

REACH Unaffected

HTSUS:

8542.39.0001

Moisture Sensitivity Level (MSL):

2 (1 Year)

ECCN:

EAR99



16-Bit, High-Speed, 2.7V to 5.5V *microPower* Sampling ANALOG-TO-DIGITAL CONVERTER

Check for Samples: [ADS8317](#)

FEATURES

- **16 Bits No Missing Codes (Full-Supply Range, High or Low Grade)**
- **Very Low Noise: 5LSB_{PP}**
- **Excellent Linearity:**
 $\pm 0.8\text{LSB}$ typ, $\pm 1.5\text{LSB}$ max INL
 $+0.7\text{LSB}$ typ, $+1.25\text{LSB}$ max DNL
 $\pm 1\text{mV}$ max Offset
 $\pm 16\text{LSB}$ typ Gain Error
- ***microPower*:**
 10mW at 5V, 250kHz
 4mW at 2.7V, 200kHz
 2mW at 2.7V, 100kHz
 0.2mW at 2.7V, 10kHz
- **Packages: MSOP-8, SON-8**
- **Pin-Compatible with the [ADS8321](#)**
- **Serial (SPI™/SSI) Interface**

APPLICATIONS

- **Battery-Operated Systems**
- **Remote Data Acquisition**
- **Isolated Data Acquisition**
- **Simultaneous Sampling, Multichannel Systems**
- **Industrial Controls**
- **Robotics**
- **Vibration Analysis**

DESCRIPTION

The ADS8317 is a 16-bit, sampling, analog-to-digital (A/D) converter specified for a supply voltage range from 2.7V to 5.5V. It requires very little power, even when operating at the full data rate. At lower data rates, the high speed of the device enables it to spend most of its time in the power-down mode. For example, the average power dissipation is less than 0.2mW at a 10kHz data rate.

The ADS8317 offers excellent linearity and very low noise and distortion. It also features a synchronous serial (SPI/SSI-compatible) interface and a differential input. The reference voltage can be set to any level within the range of 0.1V to $V_{DD}/2$.

Low power and small size make the ADS8317 ideal for portable and battery-operated systems. It is also an excellent fit for remote data-acquisition modules, simultaneous multichannel systems, and isolated data acquisition. The ADS8317 is available in MSOP-8 and SON-8 packages. The SON package size is the same as a 3x3 QFN package.

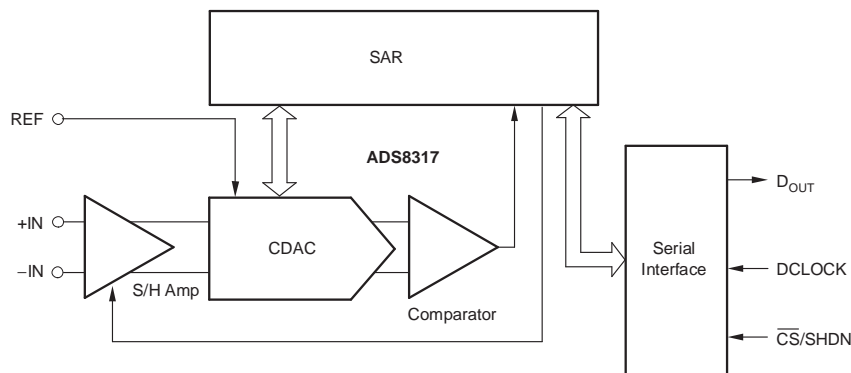

Please be aware that an important notice concerning availability, standard warranty, and use in critical applications of Texas Instruments semiconductor products and disclaimers thereto appears at the end of this data sheet.

SPI is a trademark of Motorola, Inc.

All other trademarks are the property of their respective owners.



This integrated circuit can be damaged by ESD. Texas Instruments recommends that all integrated circuits be handled with appropriate precautions. Failure to observe proper handling and installation procedures can cause damage.

ESD damage can range from subtle performance degradation to complete device failure. Precision integrated circuits may be more susceptible to damage because very small parametric changes could cause the device not to meet its published specifications.

ORDERING INFORMATION⁽¹⁾

PRODUCT	MAXIMUM INTEGRAL LINEARITY ERROR (LSB) ⁽²⁾	NO MISSING CODES ERROR (LSB)	PACKAGE-LEAD	PACKAGE DESIGNATOR	SPECIFIED TEMPERATURE RANGE	PACKAGE MARKING	ORDERING NUMBER	TRANSPORT MEDIA, QUANTITY
ADS8317I	±2	16	MSOP-8	DGK	–40°C to +85°C	D17	ADS8317IDGKT	Tape and Reel, 250
							ADS8317IDGKR	Tape and Reel, 2500
ADS8317IB	±1.5	16	MSOP-8	DGK	–40°C to +85°C	D17	ADS8317IBDGKT	Tape and Reel, 250
							ADS8317IBDGKR	Tape and Reel, 2500
ADS8317I	±2	16	SON-8	DRB	–40°C to +85°C	D17	ADS8317IDRBT	Tape and Reel, 250
							ADS8317IDRBR	Tape and Reel, 2500
ADS8317IB	±1.5	16	SON-8	DRB	–40°C to +85°C	D17	ADS8317IBDRBT	Tape and Reel, 250
							ADS8317IBDRBR	Tape and Reel, 2500

(1) For the most current package and ordering information, see the Package Option Addendum located at the end of this data sheet, or see the TI website at www.ti.com.

(2) **Maximum Integral Linearity Error** specifies a 5V power supply and 2.5V reference voltage.

ABSOLUTE MAXIMUM RATINGS⁽¹⁾

Over operating free-air temperature range (unless otherwise noted).

	ADS8317	UNIT
Supply voltage, V_{DD} to GND	–0.3 to +7	V
Analog input voltage ⁽²⁾	–0.3 to $V_{DD} + 0.3$	V
Reference input voltage ⁽²⁾	–0.3 to $V_{DD} + 0.3$	V
Digital input voltage ⁽²⁾	–0.3 to $V_{DD} + 0.3$	V
Input current to any pin except supply	–20 to +20	mA
Power dissipation	See Dissipation Ratings Table	
Operating virtual junction temperature range, T_J	–40 to +150	°C
Operating free-air temperature range, T_A	–40 to +85	°C
Storage temperature range, T_{STG}	–65 to +150	°C

(1) Stresses beyond those listed under Absolute Maximum Ratings may cause permanent damage to the device. These are stress ratings only, and functional operation of the device at these or any other conditions beyond those indicated under Recommended Operating Conditions is not implied. Exposure to absolute-maximum rated conditions for extended periods may affect device reliability.

(2) All voltage values are with respect to ground terminal.

DISSIPATION RATINGS

PACKAGE	$R_{\theta JC}$	$R_{\theta JA}$	DERATING FACTOR ABOVE $T_A = +25^\circ\text{C}$	$T_A \leq +25^\circ\text{C}$ POWER RATING	$T_A = +70^\circ\text{C}$ POWER RATING	$T_A = +85^\circ\text{C}$ POWER RATING
DGK	+39.1°C/W	+206.3°C/W	4.847mW/°C	606mW	388mW	315mW
DRB	+5°C/W	+45.8°C/W	3.7mW/°C	370mW	204mW	148mW



RECOMMENDED OPERATING CONDITIONS

		MIN	TYP	MAX	UNIT
Supply voltage, GND to V_{DD}	Low-voltage levels	2.7		3.6	V
	5V logic levels	4.5	5.0	5.5	V
Reference input voltage		1		$V_{DD}/2$	V
Analog input voltage	–IN to GND	–0.2		$V_{DD} + 0.2$	V
	+IN to GND	–0.2		$V_{DD} + 0.2$	V
	+IN – (–IN)	$-V_{REF}$		$+V_{REF}$	V
Operating junction temperature, T_J		–40		+125	°C

ELECTRICAL CHARACTERISTICS: $V_{DD} = +5V$

At –40°C to +85°C, $V_{REF} = +2.5V$, –IN = +2.5V, $f_{SAMPLE} = 250kHz$, and $f_{CLK} = 24 \times f_{SAMPLE}$, unless otherwise noted.

PARAMETER	TEST CONDITIONS	ADS8317I			ADS8317IB			UNIT	
		MIN	TYP	MAX	MIN	TYP	MAX		
ANALOG INPUT									
Full-scale range	FSR	+IN – (–IN)	$-V_{REF}$	V_{REF}	$-V_{REF}$	V_{REF}		V	
Absolute input range		+IN	–0.1	$V_{DD} + 0.1$	–0.1	$V_{DD} + 0.1$		V	
Input resistance	R_{ON}	Hold		5		5		GΩ	
		Sampling		50	100		50	100	Ω
Input capacitance		During sampling		24		24		pF	
Input leakage current				±50		±50		nA	
Differential input capacitance		+IN to –IN, during sampling		20		20		pF	
Full-power bandwidth	FSBW	f_S sinewave, SINAD = 60dB		500		500		kHz	
DC ACCURACY									
Resolution			16		16			Bits	
No missing codes	NMC			16	16		16	16	Bits
Integral linearity error	INL		–2	±1.5	+2	–1.5	±0.8	+1.5	LSB
Differential linearity error	DNL		–1	±1	+2	–1	+0.7, –0.5	+1.25	LSB
Offset error	V_{OS}		–2	±0.75	+2	–1	±0.5	+1	mV
Offset error drift	TCV_{OS}			±3			±3		μV/°C
Gain error	G_{ERR}	Positive	–32	±16	+32	–32	±16	+32	LSB
		Negative	–32	±16	+32	–32	±16	+32	LSB
Gain error drift	TCG_{ERR}			±0.1			±0.1		ppm/°C
Bipolar zero error			–2	±0.75	+2	–1	±0.5	+1	mV
Bipolar zero error drift				±3			±3		μV/°C
Noise				50			50		μVRMS
Power-supply rejection	PSRR	$4.75V \leq V_{DD} \leq 5.25V$		1			1		LSB
SAMPLING DYNAMICS									
Conversion time (16 DCLOCKS)	t_{CONV}	$24kHz \leq f_{CLK} \leq 6.0MHz$	2.667		666.7	2.667		666.7	μs
Acquisition time (4.5 DCLOCKS)	t_{AQ}	$f_{CLK} = 6.0MHz$	0.75			0.75			μs
Throughput rate (22 DCLOCKS)					250			250	kSPS
Clock frequency			0.024		6.0	0.024		6.0	MHz

ELECTRICAL CHARACTERISTICS: $V_{DD} = +5V$ (continued)At -40°C to $+85^{\circ}\text{C}$, $V_{REF} = +2.5V$, $-IN = +2.5V$, $f_{SAMPLE} = 250\text{kHz}$, and $f_{CLK} = 24 \times f_{SAMPLE}$, unless otherwise noted.

PARAMETER	TEST CONDITIONS	ADS8317I			ADS8317IB			UNIT
		MIN	TYP	MAX	MIN	TYP	MAX	
AC ACCURACY								
Total harmonic distortion	THD	$5V_{PP}$ sinewave at 2kHz	-102		-106		dB	
		$5V_{PP}$ sinewave at 10kHz	-100		-104		dB	
Spurious-free dynamic range	SFDR	$5V_{PP}$ sinewave at 2kHz	106		110		dB	
		$5V_{PP}$ sinewave at 10kHz	104		109		dB	
Signal-to-noise ratio	SNR	$5V_{PP}$ sinewave at 2kHz	89.6		90		dB	
		$5V_{PP}$ sinewave at 10kHz	89.6		90		dB	
Signal-to-noise + distortion	SINAD	$5V_{PP}$ sinewave at 2kHz	89.5		89.9		dB	
		$5V_{PP}$ sinewave at 10kHz	89.4		89.8		dB	
Effective number of bits	ENOB	$5V_{PP}$ sinewave at 2kHz	14.57		14.65		Bits	
		$5V_{PP}$ sinewave at 10kHz	14.56		14.63		Bits	
VOLTAGE REFERENCE INPUT								
Reference voltage		0.5	$V_{DD}/2$		0.5	$V_{DD}/2$		V
Reference input resistance	$\overline{CS} = \text{GND}$, $f_{SAMPLE} = 0\text{Hz}$	5		5		GΩ		
	$\overline{CS} = V_{DD}$	5		5		GΩ		
Reference input capacitance		24		24		pF		
Reference input current	$f_S = 250\text{kHz}$	35	52	35	52	μA		
	$f_S = 200\text{kHz}$	25	38	25	38	μA		
	$f_S = 100\text{kHz}$	10	15	10	15	μA		
	$f_S = 10\text{kHz}$	1	2	1	2	μA		
	$\overline{CS} = V_{DD}$	0.1		0.1		μA		
DIGITAL INPUTS⁽¹⁾								
Logic family		CMOS			CMOS			
High-level input voltage	V_{IH}	$0.7 \times V_{DD}$	$V_{DD} + 0.3$		$0.7 \times V_{DD}$	$V_{DD} + 0.3$		V
Low-level input voltage	V_{IL}	-0.3	$0.3 \times V_{DD}$		-0.3	$0.3 \times V_{DD}$		V
Input current	I_{IN}	$V_I = V_{DD}$ or GND		-50	+50		nA	
Input capacitance	C_I	5		5		pF		
DIGITAL OUTPUTS⁽¹⁾								
Logic family		CMOS			CMOS			
High-level output voltage	V_{OH}	$V_{DD} = 4.5V$, $I_{OH} = -100\mu\text{A}$	4.44		4.44		V	
Low-level output voltage	V_{OL}	$V_{DD} = 4.5V$, $I_{OL} = 100\mu\text{A}$	0.5		0.5		V	
High-impedance state output current	I_{OZ}	$\overline{CS} = V_{DD}$, $V_I = V_{DD}$ or GND		-50	+50		nA	
Output capacitance	C_O	5		5		pF		
Load capacitance	C_L	30		30		pF		
Data format		Binary twos complement			Binary twos complement			

(1) Applies for 5.0V nominal supply: $V_{DD}(\text{min}) = 4.5V$ and $V_{DD}(\text{max}) = 5.5V$.



ELECTRICAL CHARACTERISTICS: $V_{DD} = +2.7V$

At $-40^{\circ}C$ to $+85^{\circ}C$, $V_{REF} = +1.25V$, $-IN = 1.25V$, $f_{SAMPLE} = 200kHz$, and $f_{CLK} = 24 \times f_{SAMPLE}$, unless otherwise noted.

PARAMETER	TEST CONDITIONS	ADS8317I			ADS8317IB			UNIT	
		MIN	TYP	MAX	MIN	TYP	MAX		
ANALOG INPUT									
Full-scale range	FSR	+IN – (–IN)	$-V_{REF}$	V_{REF}	$-V_{REF}$	V_{REF}		V	
Absolute input range		+IN	–0.1	$V_{DD} + 0.1$	–0.1	$V_{DD} + 0.1$		V	
Input resistance	R_{ON}	Hold		5		5		GΩ	
		Sampling		100	150	100	150		Ω
Input capacitance		During sampling		24		24		pF	
Input leakage current				±50		±50		nA	
Differential input capacitance		+IN to –IN, during sampling		20		20		pF	
Full-power bandwidth	FSBW	f_S sinewave, SINAD = 60dB		1000		1000		kHz	
DC ACCURACY									
Resolution			16		16			Bits	
No missing codes	NMC			16	16		16	16	Bits
Integral linearity error	INL		–3	±2	+3	–2	±1.5	+2	LSB
Differential linearity error	DNL		–1	+1.5, –1	+2.5	–1	±1	+2	LSB
Offset error	V_{OS}		–2	±1	+2	–1	±0.5	+1	mV
Offset error drift	TCV_{OS}			±0.4		±0.4			μV/°C
Gain error	G_{ERR}	Positive	–32	±16	+32	–32	±16	+32	LSB
		Negative	–32	±16	+32	–32	±16	+32	LSB
Gain error drift	TCG_{ERR}			±0.15		±0.15			ppm/°C
Bipolar zero error			–2	±0.8	+2	–1	±0.4	+1	mV
Bipolar zero error drift				±0.2		±0.2			μV/°C
Noise				50		50			μVRMS
Power-supply rejection	PSRR	$2.7V \leq V_{DD} \leq 3.6V$		1		1			LSB
SAMPLING DYNAMICS									
Conversion time (16 DCLOCKS)	t_{CONV}	$24kHz \leq f_{CLK} \leq 4.8MHz$	3.333		666.7	3.333		666.7	μs
Acquisition time (4.5 DCLOCKS)	t_{AQ}	$f_{CLK} = 4.8MHz$	0.9375			0.9375			μs
Throughput rate (22 DCLOCKS)					200			200	kSPS
Clock frequency			0.024		4.8	0.024		4.8	MHz
AC ACCURACY									
Total harmonic distortion	THD	2.5V _{PP} sinewave at 2kHz		–104		–107			dB
		2.5V _{PP} sinewave at 10kHz		–101		–106			dB
Spurious-free dynamic range	SFDR	2.5V _{PP} sinewave at 2kHz		106		108			dB
		2.5V _{PP} sinewave at 10kHz		104		107			dB
Signal-to-noise ratio	SNR	2.5V _{PP} sinewave at 2kHz		84.8		85			dB
		2.5V _{PP} sinewave at 10kHz		84.8		85			dB
Signal-to-noise + distortion	SINAD	2.5V _{PP} sinewave at 2kHz		84.7		84.9			dB
		2.5V _{PP} sinewave at 10kHz		84.7		84.8			dB
Effective number of bits	ENOB	2.5V _{PP} sinewave at 2kHz		13.77		13.8			Bits
		2.5V _{PP} sinewave at 10kHz		13.77		13.79			Bits
VOLTAGE REFERENCE INPUT									
Reference voltage			1		$V_{DD}/2$	1		$V_{DD}/2$	V
Reference input resistance		$\overline{CS} = GND$, $f_{SAMPLE} = 0Hz$		5		5			kΩ
		$\overline{CS} = V_{DD}$		5		5			GΩ
Reference input capacitance				20		20			pF
Reference input current		$f_S = 200kHz$		9	14	9	14		μA
		$f_S = 100kHz$		3	5	3	5		μA
		$f_S = 10kHz$		0.5	1	0.5	1		μA
		$\overline{CS} = V_{DD}$		0.1		0.1			μA

ELECTRICAL CHARACTERISTICS: $V_{DD} = +2.7V$ (continued)

At $-40^{\circ}C$ to $+85^{\circ}C$, $V_{REF} = +1.25V$, $-IN = 1.25V$, $f_{SAMPLE} = 200kHz$, and $f_{CLK} = 24 \times f_{SAMPLE}$, unless otherwise noted.

PARAMETER	TEST CONDITIONS	ADS8317I			ADS8317IB			UNIT
		MIN	TYP	MAX	MIN	TYP	MAX	
DIGITAL INPUTS⁽¹⁾								
Logic family		LVCMOS			LVCMOS			
High-level input voltage	V_{IH} $V_{DD} = 3.6V$	2		$V_{DD} + 0.3$	2		$V_{DD} + 0.3$	V
Low-level input voltage	V_{IL} $V_{DD} = 2.7V$	-0.3		0.8	-0.3		$0.3 \times V_{DD}$	V
Input current	I_{IN} $V_i = V_{DD}$ or GND	-50		+50	-50		+50	nA
Input capacitance	C_i		5			5		pF
DIGITAL OUTPUTS⁽¹⁾								
Logic family		LVCMOS			LVCMOS			
High-level output voltage	V_{OH} $V_{DD} = 2.7V$, $I_{OH} = -100\mu A$	$V_{DD} - 0.2$			$V_{DD} - 0.2$			V
Low-level output voltage	V_{OL} $V_{DD} = 2.7V$, $I_{OL} = 100\mu A$	0.2			0.2			V
High-impedance state output current	I_{OZ} $\overline{CS} = V_{DD}$, $V_i = V_{DD}$ or GND	-50		+50	-50		+50	nA
Output capacitance	C_o		5			5		pF
Load capacitance	C_L			30			30	pF
Data format		Binary twos complement			Binary twos complement			

(1) Applies for 5.0V nominal supply: $V_{DD}(\min) = 2.7V$ and $V_{DD}(\max) = 3.6V$.

ELECTRICAL CHARACTERISTICS: GENERAL

At $-40^{\circ}C$ to $+85^{\circ}C$, $-IN = GND$, and $f_{DCLOCK} = 24 \times f_{SAMPLE}$, unless otherwise noted.

PARAMETER	TEST CONDITIONS	ADS8317I			ADS8317IB			UNIT	
		MIN	TYP	MAX	MIN	TYP	MAX		
ANALOG INPUT									
Power supply	V_{DD}	Low-voltage levels	2.7		3.6	2.7		3.6	V
		5V logic levels	4.5		5.5	4.5		5.5	V
Operating supply current	I_{DD}	$V_{DD} = 2.7V$, $f_S = 10kHz$, $f_{DCLOCK} = 4.8MHz$		0.065	0.085		0.065	0.085	mA
		$V_{DD} = 2.7V$, $f_S = 100kHz$, $f_{DCLOCK} = 4.8MHz$		0.7	1.0		0.7	1.0	mA
		$V_{DD} = 2.7V$, $f_S = 200kHz$, $f_{DCLOCK} = 4.8MHz$		1.4	2.0		1.4	2.0	mA
		$V_{DD} = 5V$, $f_S = 200kHz$, $f_{DCLOCK} = 6MHz$		1.5	2.5		1.5	2.5	mA
		$V_{DD} = 5V$, $f_S = 250kHz$, $f_{DCLOCK} = 6MHz$		2.0	3.0		2.0	3.0	mA
Power-down supply current	I_{DD}	$V_{DD} = 2.7V$		0.1			0.1	μA	
		$V_{DD} = 5V$		0.2			0.2	μA	
Power dissipation		$V_{DD} = 2.7V$, $f_S = 10kHz$, $f_{DCLOCK} = 4.8MHz$		0.18	0.23		0.18	0.23	mW
		$V_{DD} = 2.7V$, $f_S = 100kHz$, $f_{DCLOCK} = 4.8MHz$		1.9	2.7		1.9	2.7	mW
		$V_{DD} = 2.7V$, $f_S = 200kHz$, $f_{DCLOCK} = 4.8MHz$		3.8	5.4		3.8	5.4	mW
		$V_{DD} = 5V$, $f_S = 200kHz$, $f_{DCLOCK} = 6MHz$		7.5	12.5		7.5	12.5	mW
		$V_{DD} = 5V$, $f_S = 250kHz$, $f_{DCLOCK} = 6MHz$		10	15		10	15	mW
Power dissipation in power-down		$V_{DD} = 2.7V$, $\overline{CS} = V_{DD}$		0.3			0.3	μW	
		$V_{DD} = 5V$, $\overline{CS} = V_{DD}$		0.6			0.6	μW	

PIN CONFIGURATION

DGK PACKAGE MSOP-8 (TOP VIEW)

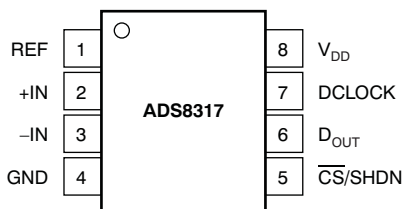

DRB PACKAGE SON-8 (TOP VIEW)

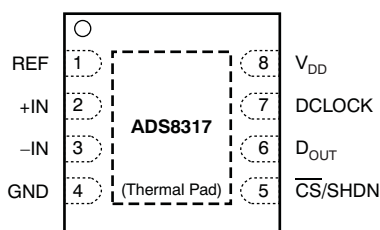

- (1) The DRB package thermal pad must be soldered to the printed circuit board for proper thermal and mechanical performance.

TERMINAL FUNCTIONS

TERMINAL		I/O	DESCRIPTION
NAME	NO.		
REF	1	Analog input	Reference input
+IN	2	Analog input	Noninverting analog input
-IN	3	Analog input	Inverting analog input
GND	4	Power-supply connection	Ground
$\overline{\text{CS}}/\text{SHDN}$	5	Digital input	Chip select when low; Shutdown mode when high.
D _{OUT}	6	Digital output	Serial output data word
DCLOCK	7	Digital input	Data clock synchronizes the serial data transfer and determines conversion speed.
V _{DD}	8	Power-supply connection	Power supply

Equivalent Input Circuits ($V_{DD} = 5.0V$)

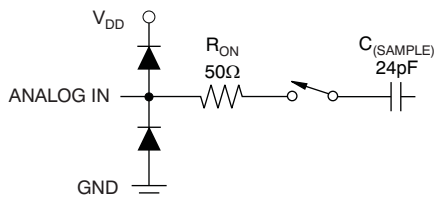

Diode Turn-On Voltage: 0.35V
Equivalent Analog Input Circuit

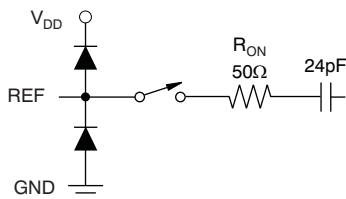

Equivalent Reference Input Circuit

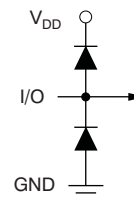

Equivalent Digital Input/Output Circuit

TIMING INFORMATION

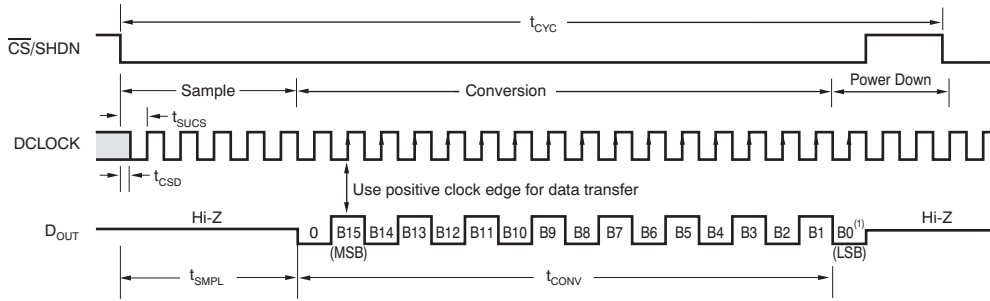

NOTE: (1) A minimum of 22 clock cycles are required for 16-bit conversion; 24 clock cycles are shown. If CS remains low at the end of conversion, a new data stream is shifted out with LSB-first data followed by zeroes indefinitely.

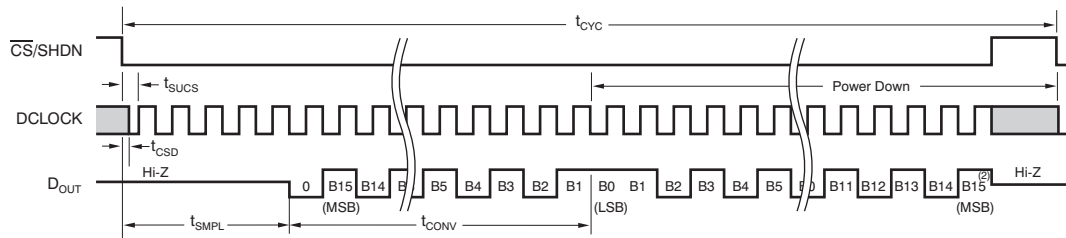

NOTE: (2) After completing the data transfer, if further clocks are applied with CS low, the A/D converter will output zeroes indefinitely.

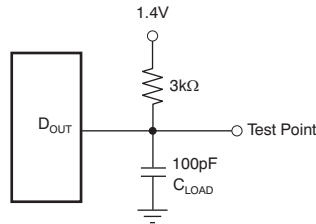

Load Circuit for t_{dD} , t_r , and t_f

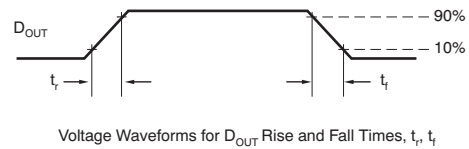

Voltage Waveforms for D_{OUT} Rise and Fall Times, t_r , t_f

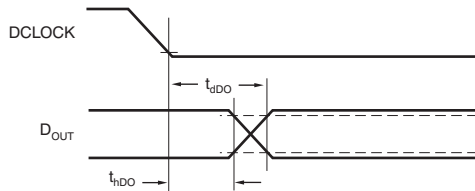

Voltage Waveforms for D_{OUT} Delay Times, t_{dD}

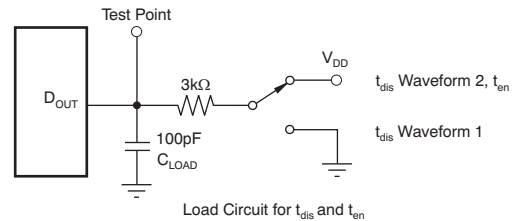

Load Circuit for t_{dis} and t_{en}

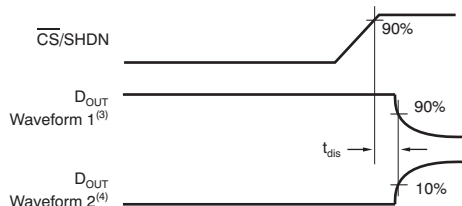

Voltage Waveforms for t_{dis}

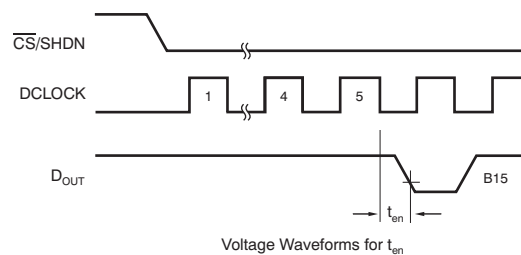

Voltage Waveforms for t_{en}

NOTES: (3) Waveform 1 is for an output with internal conditions such that the output is high unless disabled by the output control.
 (4) Waveform 2 is for an output with internal conditions such that the output is low unless disabled by the output control.

Figure 1. Timing Diagrams



TIMING INFORMATION (continued)

Timing Characteristics

SYMBOL	DESCRIPTION	MIN	TYP	MAX	UNIT
t_{SMPL}	Analog input sample time	4.5		5.0	DCLOCKS
t_{CONV}	Conversion time		16		DCLOCKS
t_{CYC}	Complete cycle time	22			DCLOCKS
t_{CSD}	$\overline{\text{CS}}$ falling to DCLOCK low			0	ns
t_{SUCS}	$\overline{\text{CS}}$ falling to DCLOCK rising	20			ns
t_{HDO}	DCLOCK falling to current D_{OUT} not valid	5	15		ns
t_{DIS}	$\overline{\text{CS}}$ rising to D_{OUT} 3-state		70	100	ns
t_{EN}	DCLOCK falling to D_{OUT} enabled		20	50	ns
t_{F}	D_{OUT} fall time		5	25	ns
t_{R}	D_{OUT} rise time		7	25	ns

TYPICAL CHARACTERISTICS: $V_{DD} = +5V$

At $T_A = 25^\circ C$, $V_{REF} = 2.5V$, $f_{SAMPLE} = 250KHz$, $f_{CLK} = 24 \times f_{SAMPLE}$, unless otherwise noted.

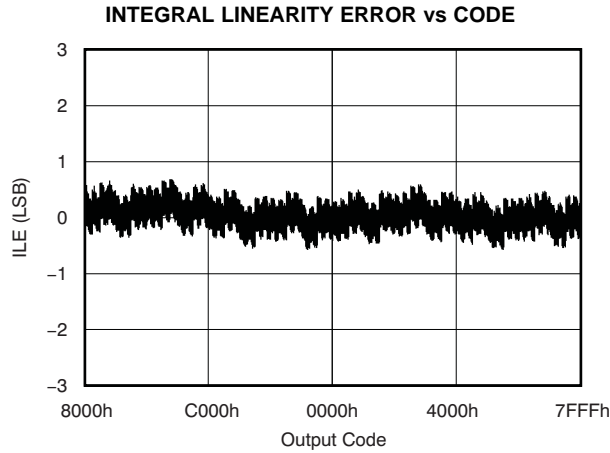

Figure 2.

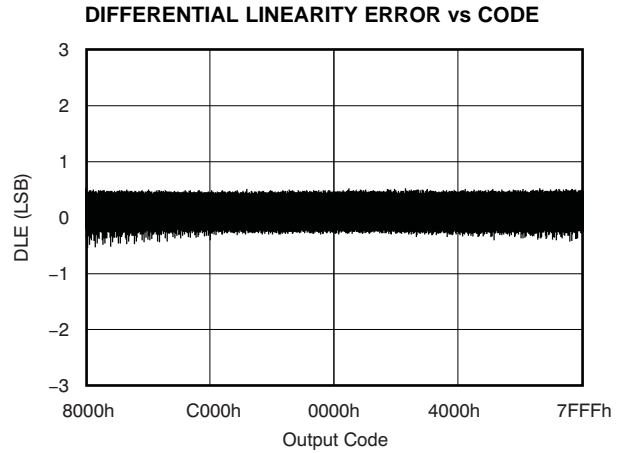

Figure 3.

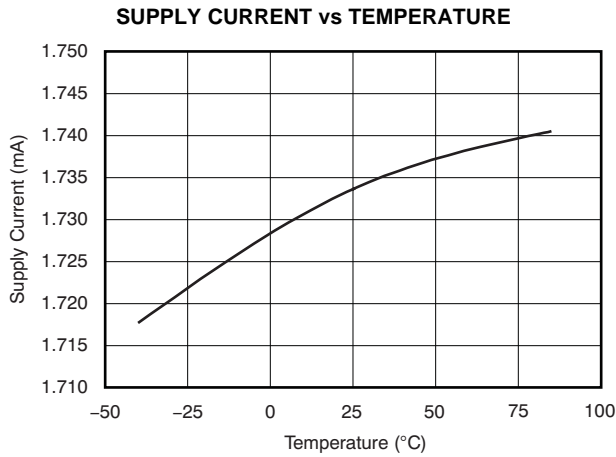

Figure 4.

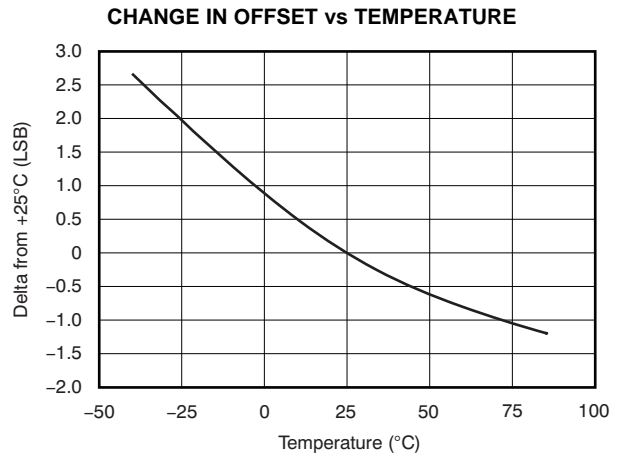

Figure 5.

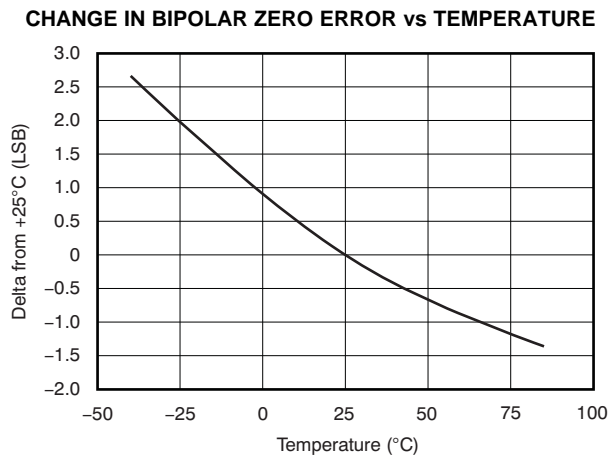

Figure 6.

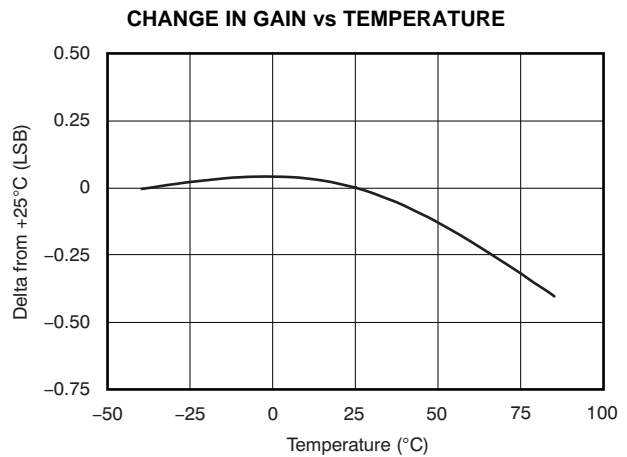

Figure 7.

TYPICAL CHARACTERISTICS: $V_{DD} = +5V$ (continued)

At $T_A = 25^\circ C$, $V_{REF} = 2.5V$, $f_{SAMPLE} = 250kHz$, $f_{CLK} = 24 \times f_{SAMPLE}$, unless otherwise noted.

POWER-DOWN CURRENT vs TEMPERATURE

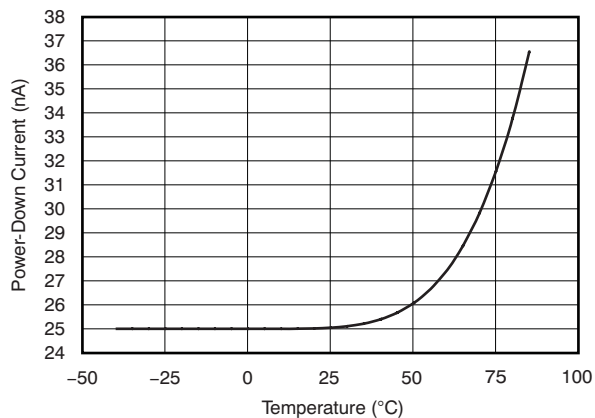

Figure 8.

SUPPLY CURRENT vs SAMPLING RATE

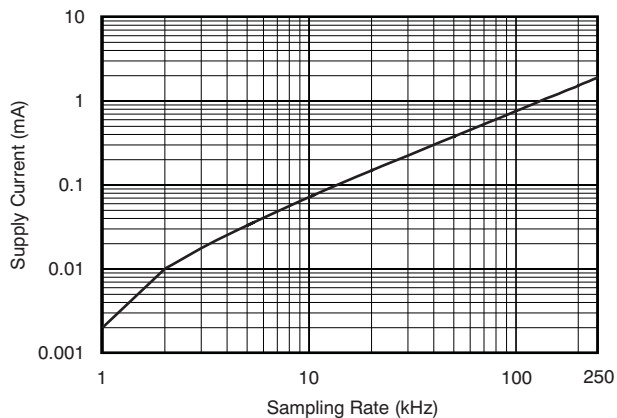

Figure 9.

REFERENCE CURRENT vs SAMPLING RATE

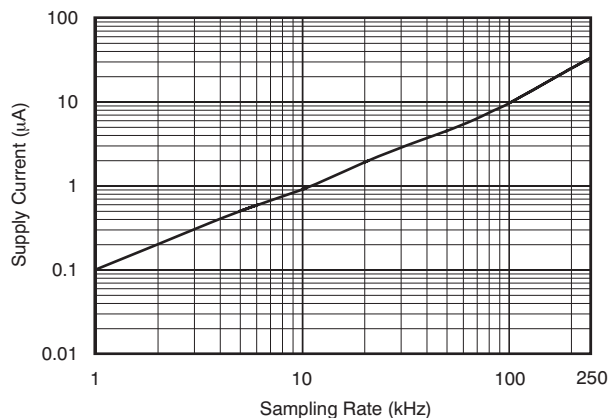

Figure 10.

FREQUENCY SPECTRUM (8192 point FFT, $f_{IN} = 1.9836kHz$, $-0.2dB$)

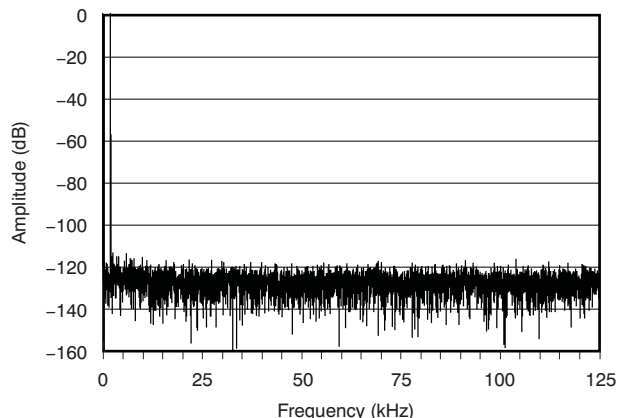

Figure 11.

FREQUENCY SPECTRUM (8192 Point FFT, $f_{IN} = 9.9792kHz$, $-0.2dB$)

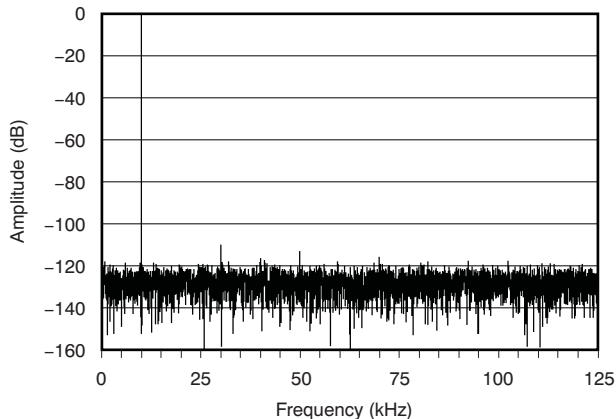

Figure 12.

SIGNAL-TO-NOISE RATIO AND SIGNAL-TO-NOISE + DISTORTION vs INPUT FREQUENCY

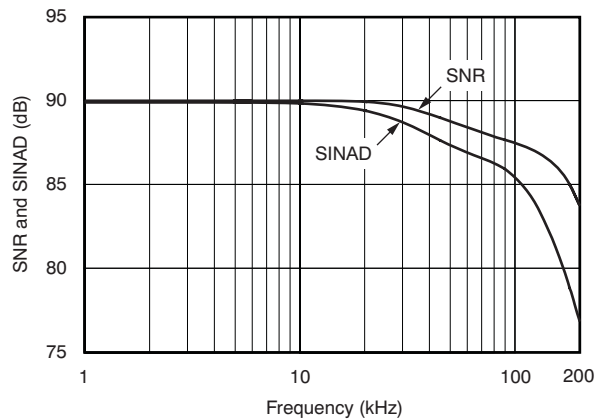

Figure 13.

TYPICAL CHARACTERISTICS: $V_{DD} = +5V$ (continued)

At $T_A = 25^\circ C$, $V_{REF} = 2.5V$, $f_{SAMPLE} = 250kHz$, $f_{CLK} = 24 \times f_{SAMPLE}$, unless otherwise noted.

SPURIOUS-FREE DYNAMIC RANGE AND TOTAL HARMONIC DISTORTION vs INPUT FREQUENCY

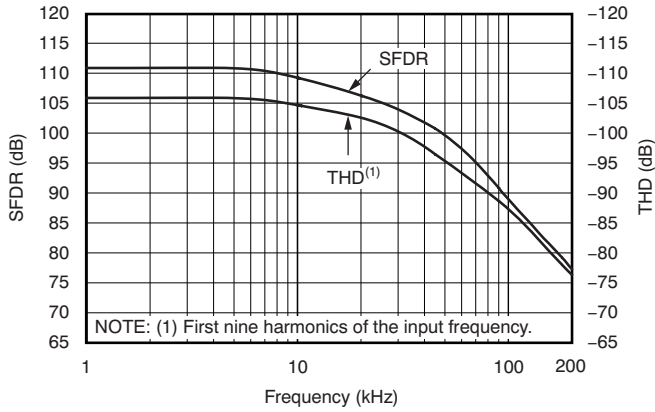

Figure 14.

EFFECTIVE NUMBER OF BITS vs INPUT FREQUENCY

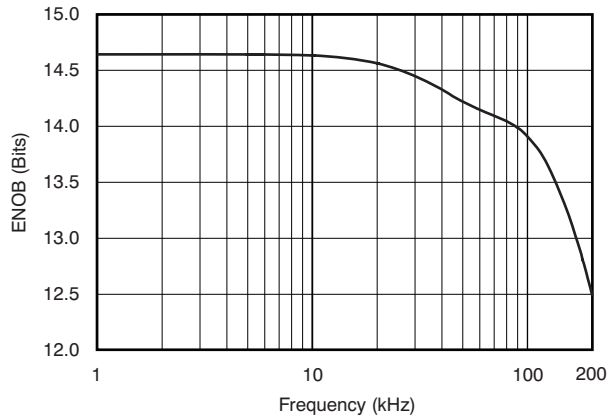

Figure 15.

CHANGE IN SIGNAL-TO-NOISE + DISTORTION vs TEMPERATURE

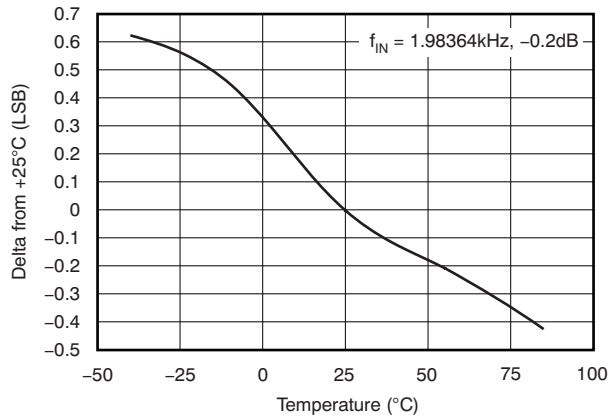

Figure 16.

CHANGE IN SIGNAL-TO-NOISE + DISTORTION vs INPUT LEVEL

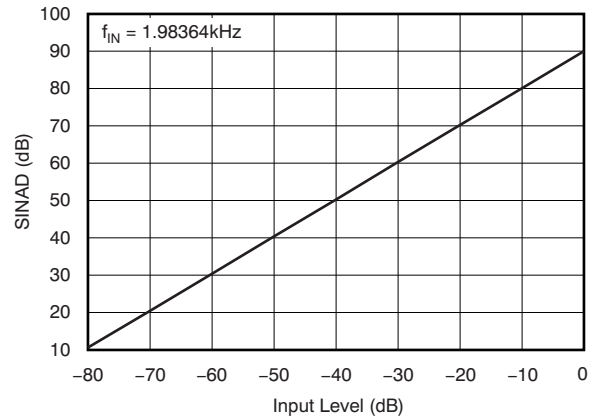

Figure 17.

PEAK-TO-PEAK NOISE FOR A DC INPUT vs REFERENCE VOLTAGE

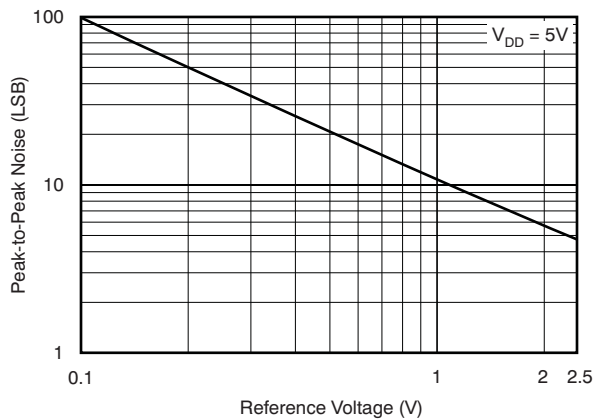

Figure 18.

OUTPUT CODE HISTOGRAM FOR A DC INPUT (8192 Conversions)

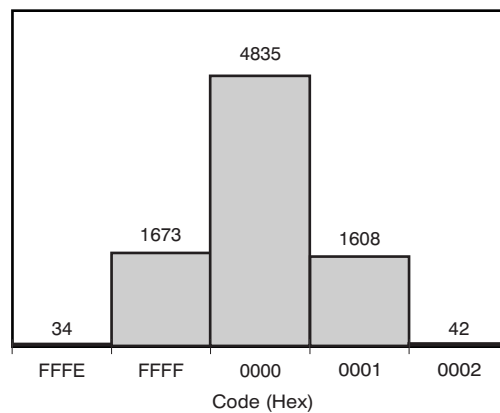

Figure 19.

TYPICAL CHARACTERISTICS: $V_{DD} = +2.7V$

At $T_A = 25^\circ C$, $V_{REF} = 1.25V$, $f_{SAMPLE} = 200kHz$, $f_{CLK} = 24 \times f_{SAMPLE}$, unless otherwise noted.

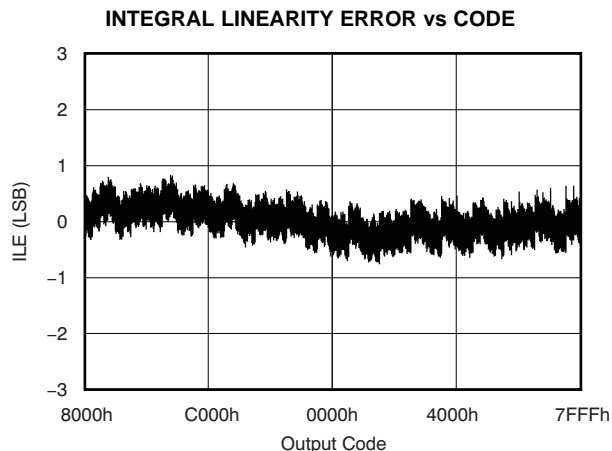

Figure 20.

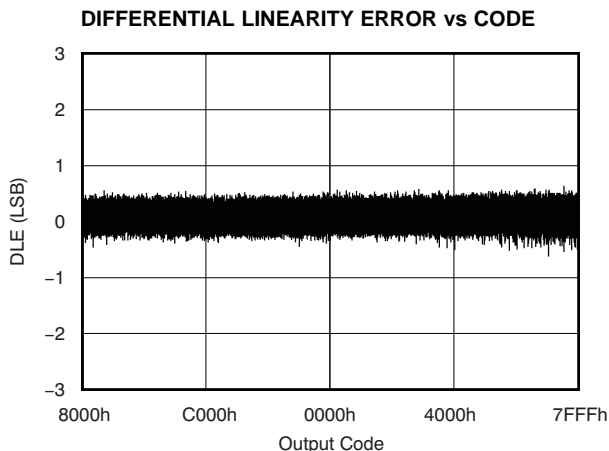

Figure 21.

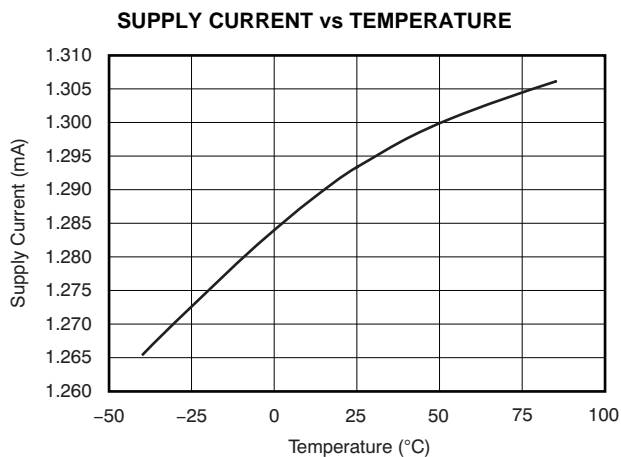

Figure 22.

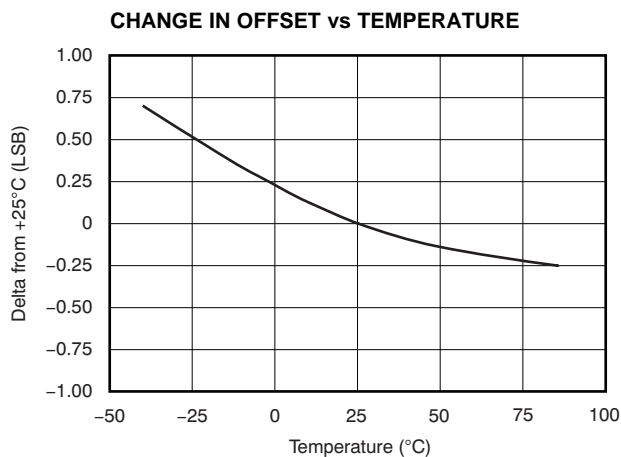

Figure 23.

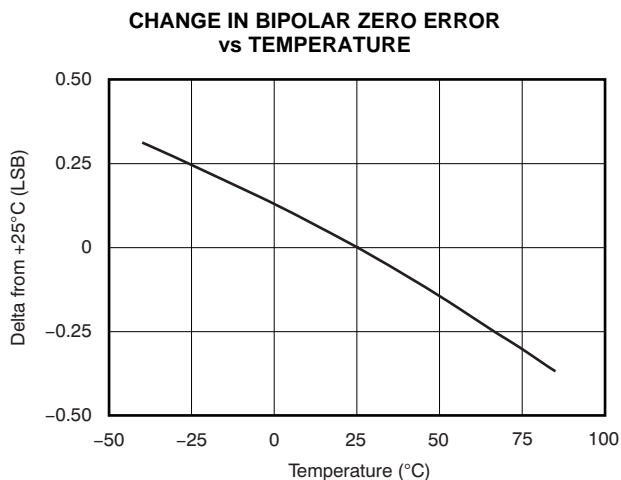

Figure 24.

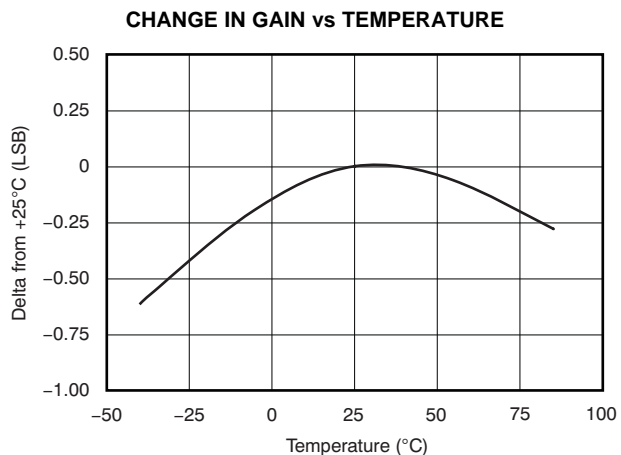

Figure 25.

TYPICAL CHARACTERISTICS: $V_{DD} = +2.7V$ (continued)

At $T_A = 25^\circ C$, $V_{REF} = 1.25V$, $f_{SAMPLE} = 200kHz$, $f_{CLK} = 24 \times f_{SAMPLE}$, unless otherwise noted.

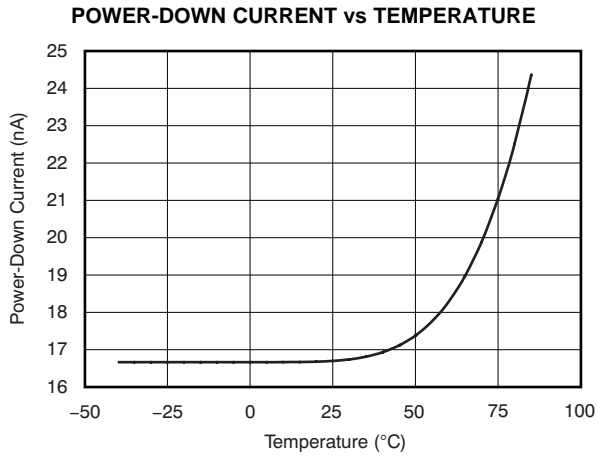

Figure 26.

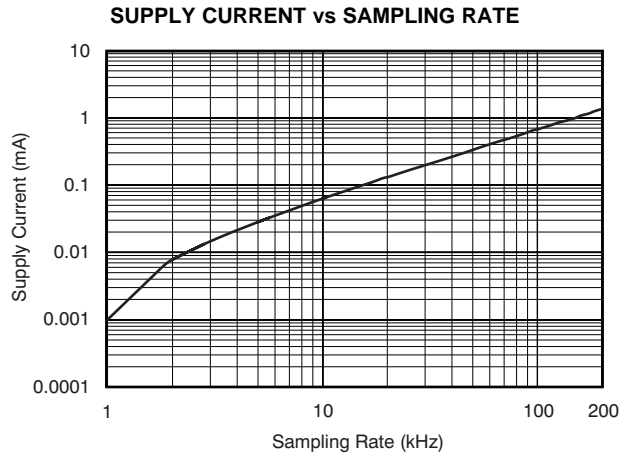

Figure 27.

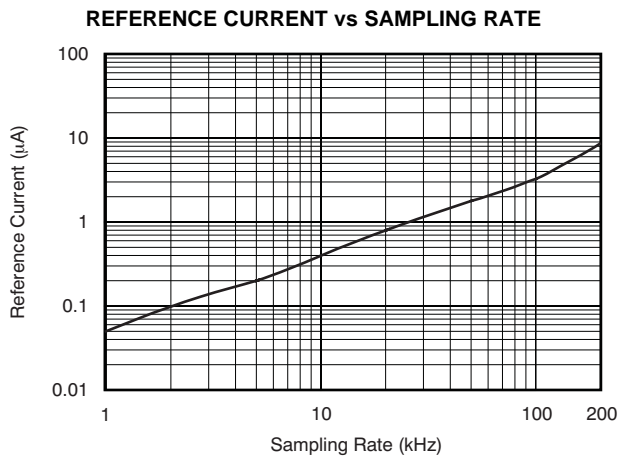

Figure 28.

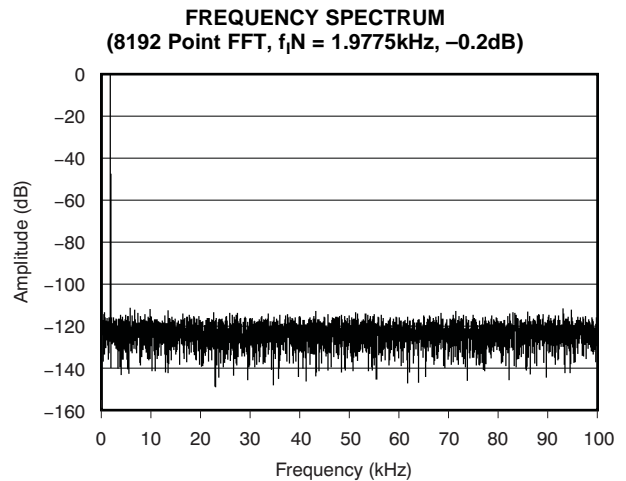

Figure 29.

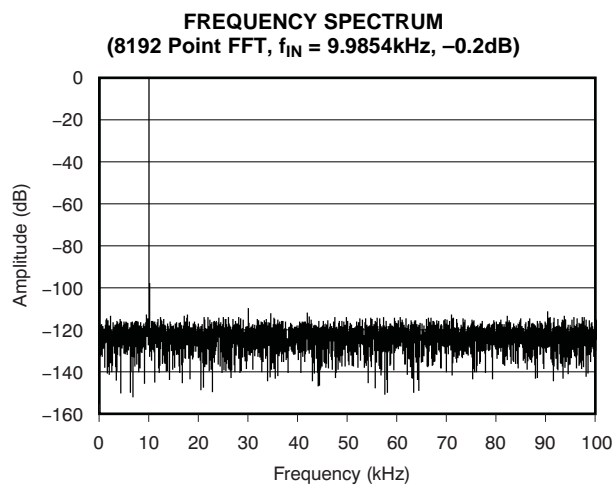

Figure 30.

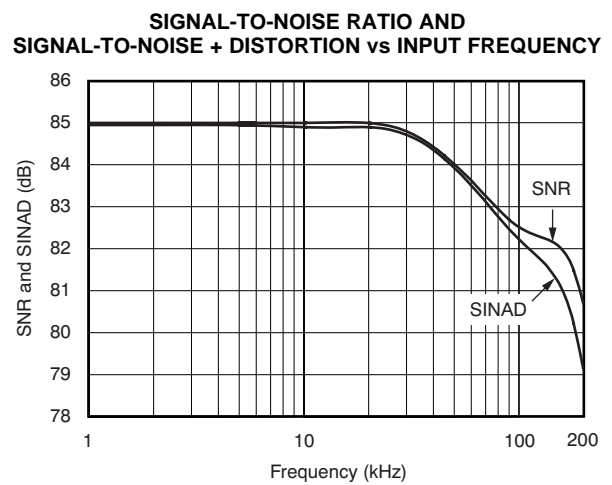

Figure 31.

TYPICAL CHARACTERISTICS: $V_{DD} = +2.7V$ (continued)

At $T_A = 25^\circ C$, $V_{REF} = 1.25V$, $f_{SAMPLE} = 200kHz$, $f_{CLK} = 24 \times f_{SAMPLE}$, unless otherwise noted.

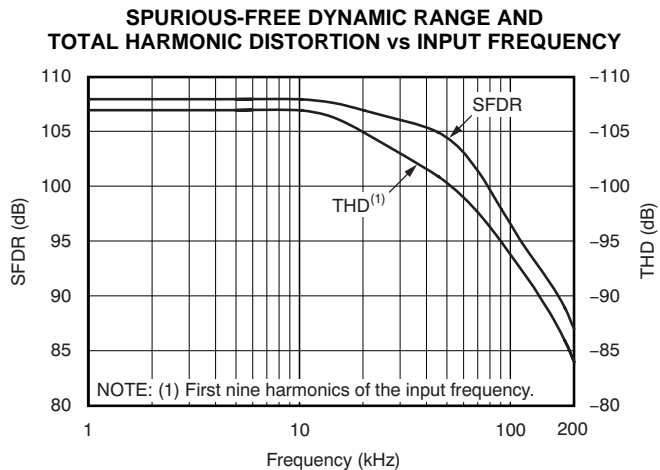

Figure 32.

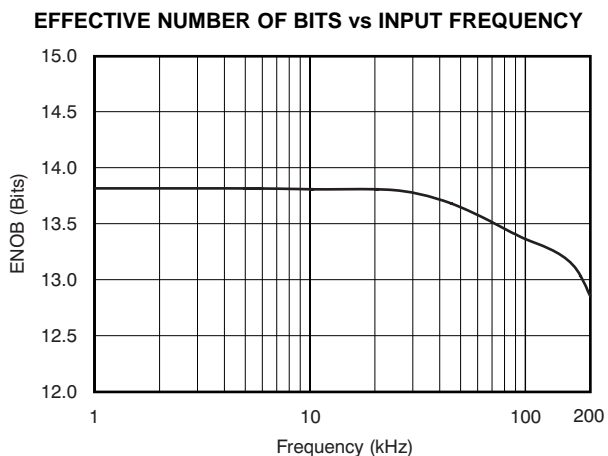

Figure 33.

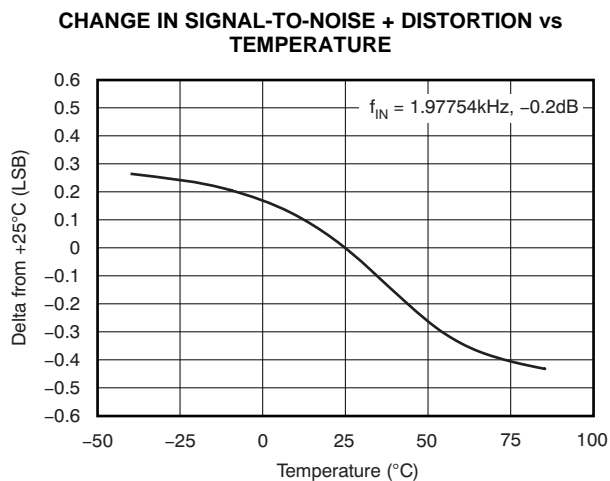

Figure 34.

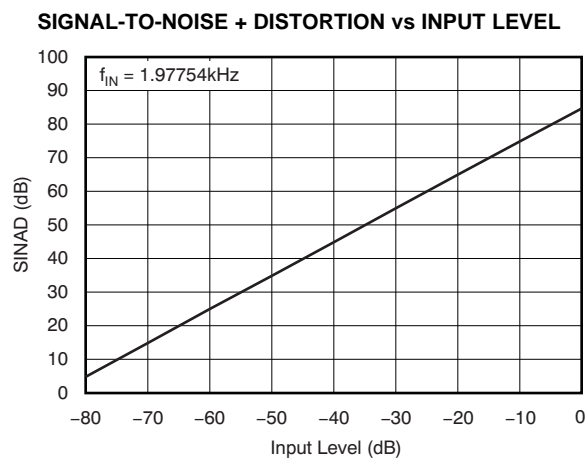

Figure 35.

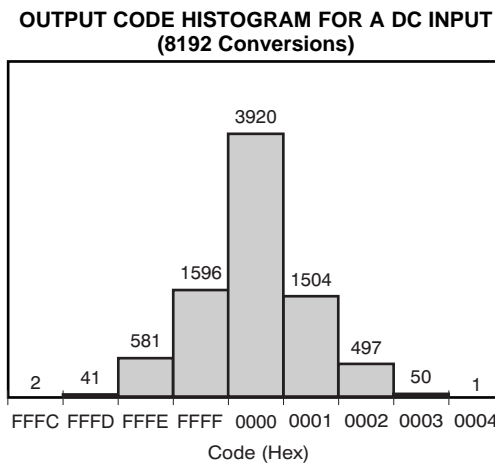

Figure 36.

THEORY OF OPERATION

The ADS8317 is a classic Successive Approximation Register (SAR) analog-to-digital (A/D) converter. The architecture is based on capacitive redistribution that inherently includes a sample-and-hold function. The converter is fabricated on a 0.6 μ CMOS process. The architecture and fabrication process allow the ADS8317 to acquire and convert an analog signal at up to 250,000 conversions per second while consuming less than 10mW from V_{DD} .

Differential linearity for the ADS8317 is factory-adjusted via a package-level trim procedure. The state of the trim elements is stored in non-volatile memory and is continuously updated after each acquisition cycle, just prior to the start of the successive approximation operation. This process ensures that one complete conversion cycle always returns the part to its factory-adjusted state in the event of a power interruption.

The ADS8317 requires an external reference, an external clock, and a single power source (V_{DD}). The external reference can be any voltage between 0.1V and $V_{DD}/2$. The value of the reference voltage directly sets the range of the analog input. The reference input current depends on the conversion rate of the ADS8317.

The external clock can vary between 24kHz (1kHz throughput) and 6.0MHz (250kHz throughput). The duty cycle of the clock is not significant, as long as the minimum high and low times are at least 200ns ($V_{DD} = 4.75V$ or greater). The minimum clock frequency is set by the leakage on the internal capacitors to the ADS8317.

The analog input is provided to two input pins: +IN and –IN. When a conversion is initiated, the differential input on these pins is sampled on the internal capacitor array. While a conversion is in progress, both inputs are disconnected from any internal function.

The digital result of the conversion is clocked out by the DCLOCK input and is provided serially (most significant bit first) on the D_{OUT} pin.

The digital data that are provided on the D_{OUT} pin are for the conversion currently in progress—there is no pipeline delay. It is possible to continue to clock the ADS8317 after the conversion is complete and to obtain the serial data least significant bit first. See the *Digital Timing* section for more information.

ANALOG INPUT

The analog input is bipolar and fully differential. There are two general methods of driving the analog input of the ADS8317: single-ended or differential, as shown in Figure 37. When the input is single-ended, the –IN input is held at a fixed voltage. The +IN input swings around the same voltage and the peak-to-peak amplitude is $2 \times V_{REF}$. The value of V_{REF} determines the range over which the common voltage may vary, as shown in Figure 38 and Figure 39.

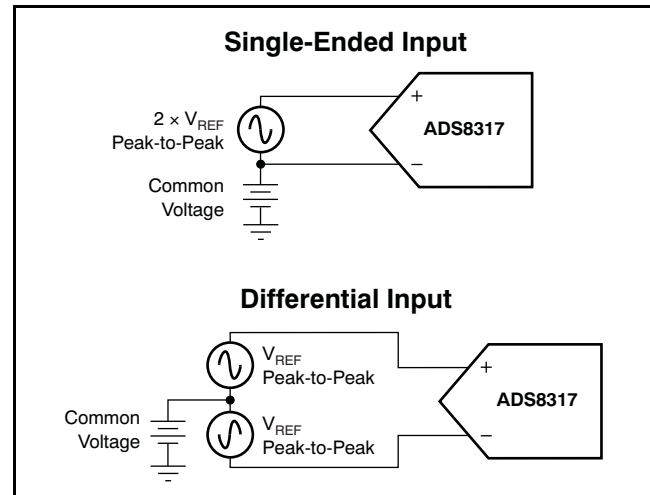

Figure 37. Methods of Driving the ADS8317—Single-Ended or Differential

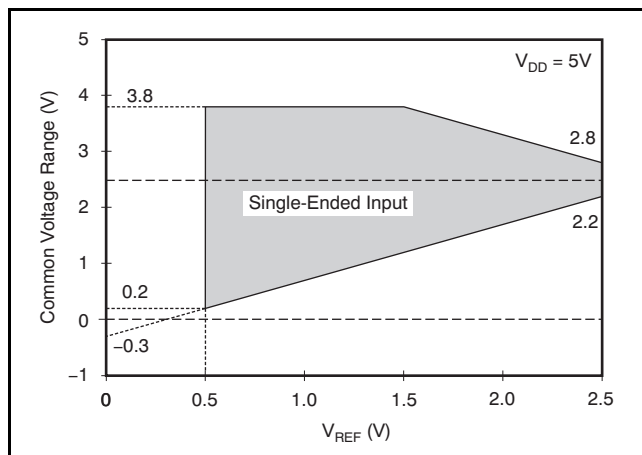

Figure 38. Single-Ended 5V Input, Common Voltage Range vs V_{REF}

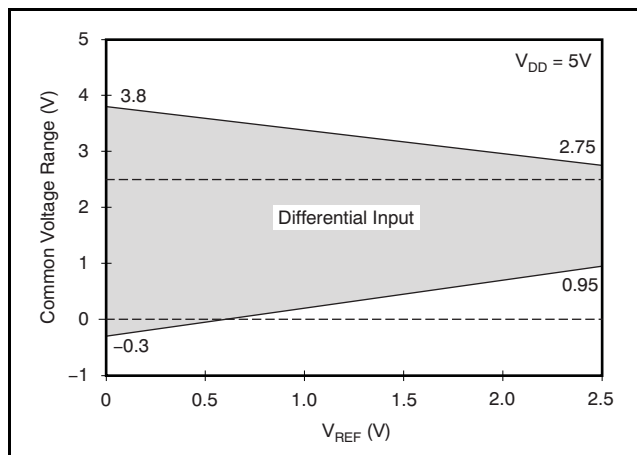

Figure 40. Differential 5V Input, Common Voltage Range vs V_{REF}

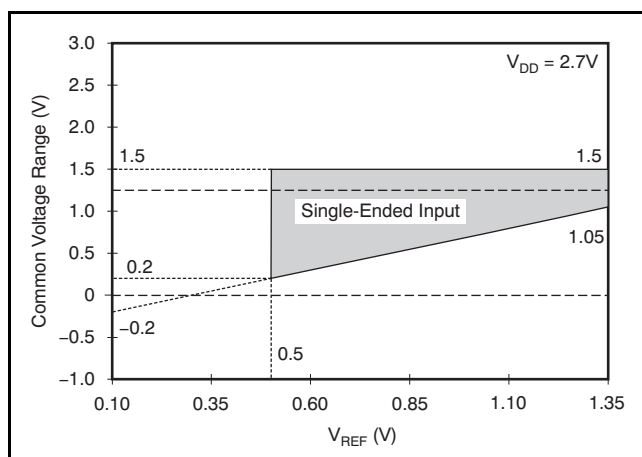

Figure 39. Single-Ended 2.7V Input, Common Voltage Range vs V_{REF}

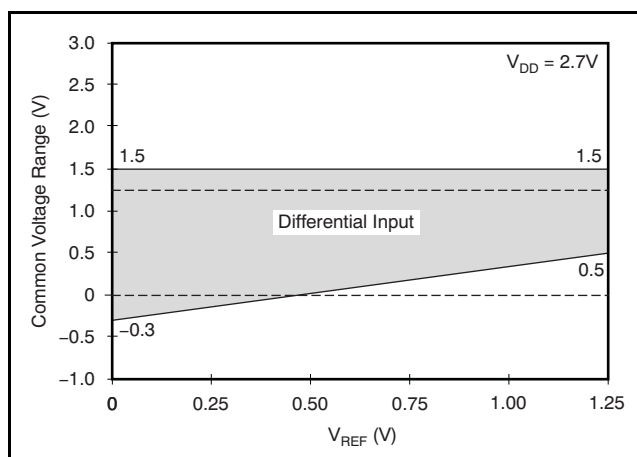

Figure 41. Differential 2.7V Input, Common Voltage Range vs V_{REF}

When the input is differential, the amplitude of the input is the difference between the +IN and –IN input, or +IN – (–IN). A voltage or signal is common to both of these inputs. The peak-to-peak amplitude of each input is V_{REF} about this common voltage. However, since the inputs are 180° out-of-phase, the peak-to-peak amplitude of the difference voltage is $2 \times V_{REF}$. The value of V_{REF} also determines the range of the voltage that may be common to both inputs, as shown in [Figure 41](#) and [Figure 40](#).

In each case, care should be taken to ensure that the output impedance of the sources driving the +IN and –IN inputs are matched. If this matching is not observed, the two inputs could have different settling times. This difference may result in offset error, gain error, and linearity error that change with both temperature and input voltage. If the impedance cannot be matched, the errors can be lessened by giving the ADS8317 additional acquisition time.

The input current on the analog inputs depends on a number of factors: sample rate, input voltage, and source impedance. Essentially, the current into the ADS8317 charges the internal capacitor array during the sample period. After this capacitance has been fully charged, there is no further input current. The source of the analog input voltage must be able to charge the input capacitance (24pF) to 16-bit settling level within 4.5 clock cycles. When the converter goes into the hold mode, or while it is in the power-down mode, the input impedance is greater than 1GΩ.

Care must be taken regarding the absolute analog input voltage. The +IN input should always remain within the range of GND – 300mV to $V_{DD} + 300mV$. The –IN input should always remain within the range of GND – 300mV to 4V. Outside of these ranges, the converter linearity may not meet specifications. To obtain maximum performance from the ADS8317, an input circuit such as that shown in Figure 42 is recommended.

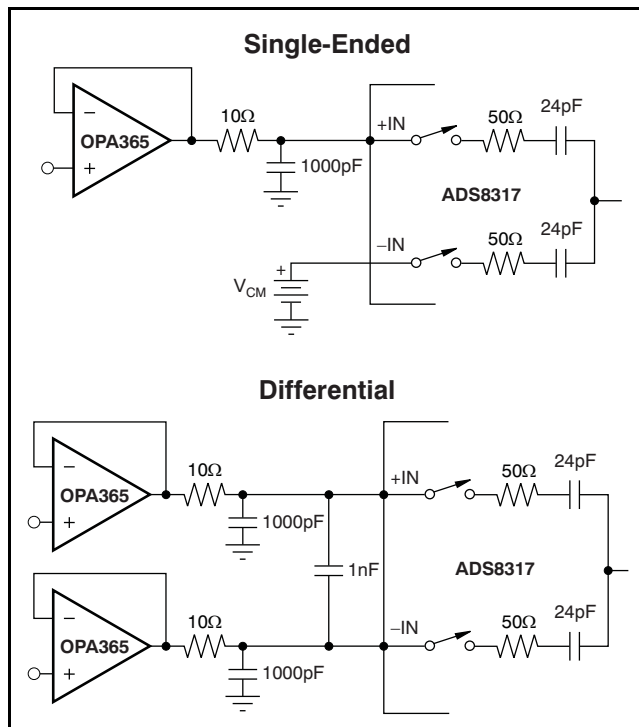

Figure 42. Single-Ended and Differential Methods of Interfacing the ADS8317

REFERENCE INPUT

The external reference sets the analog input range. The ADS8317 operates with a reference in the range of 0.1V to $V_{DD}/2$. There are several important implications to this specification.

As the reference voltage is reduced, the analog voltage weight of each digital output code is reduced. This reduction is often referred to as the least significant bit (LSB) size and is equal to the reference voltage divided by 65,536. This relationship means that any offset or gain error inherent in the A/D converter appears to increase (in terms of LSB size) as the reference voltage is reduced. For a reference voltage of 2.5V, the value of the LSB is 76.3μV, and for a reference voltage of 1.25V, the LSB is 38.15μV.

The noise inherent in the converter also appears to increase with a lower LSB size. With a 2.5V reference, the internal noise of the converter typically contributes only 5LSB peak-to-peak of potential error to the output code. When the external reference is 1.25V, the potential error contribution from the internal noise is almost two times larger (9LSB). The errors arising from the internal noise are Gaussian in nature and can be reduced by averaging consecutive conversion results.

For more information regarding noise, consult Figure 18, *Peak-to-Peak Noise for a DC Input vs Reference Voltage*. Note that the Effective Number Of Bits (ENOB) figure is calculated based on the converter signal-to-(noise + distortion) ratio with a 2kHz, 0dB input signal. SINAD is related to ENOB as follows:

$$\text{SINAD} = 6.02 \times \text{ENOB} + 1.76$$

With lower reference voltages, extra care should be taken to provide a clean layout including adequate bypassing, a clean power supply, a low-noise reference, and a low-noise input signal. Due to the lower LSB size, the converter is also more sensitive to external sources of error, such as nearby digital signals and electromagnetic interference.

The equivalent input circuit for the reference voltage is presented in [Figure 43](#). At the same time, an equivalent capacitor of 24pF is switched. To obtain optimum performance from the ADS8317, special care must be taken in designing the interface circuit to the reference input pin. To ensure a stable reference voltage, a 47μF tantalum capacitor with low ESR should be connected as close as possible to the input pin. If a high output impedance reference source is used, an additional operational amplifier with a current-limiting resistor must be placed in front of the capacitors.

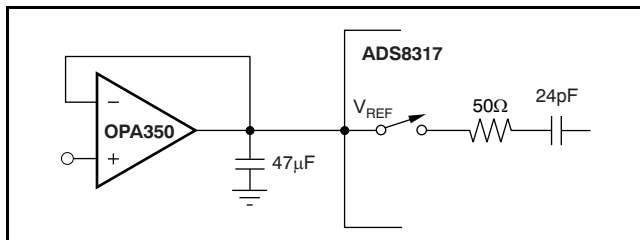

Figure 43. Input Reference Circuit and Interface

When the ADS8317 is in power-down mode, the input resistance of the reference pin has a value of 5GΩ. Because the input capacitors must be recharged before the next conversion starts, an operational amplifier with good dynamic characteristics, such as the [OPA350](#), should be used to buffer the reference input.

Noise

The transition noise of the ADS8317 itself is extremely low, as shown in [Figure 19](#) and [Figure 36](#); it is much lower than competing A/D converters. These histograms were generated by applying a low-noise DC input and initiating 8192 conversions. The digital output of the A/D converter varies in output code because of the internal noise of the ADS8317. This variance is true for all 16-bit, SAR-type A/D converters. Using a histogram to plot the output codes, the distribution should appear bell-shaped with the peak of the bell curve representing the nominal code for the input value. The $\pm 1\sigma$, $\pm 2\sigma$, and $\pm 3\sigma$ distributions represent 68.3%, 95.5%, and 99.7%, respectively, of all codes. The transition noise can be calculated by dividing the number of codes measured by 6, which yields the $\pm 3\sigma$ distribution, or 99.7%, of all codes. Statistically, up to three codes could fall outside the distribution when executing 1000 conversions. The ADS8317, with five output codes for the $\pm 3\sigma$ distribution, yields less than $\pm 0.8\text{LSB}$ of transition noise. Remember that to achieve this low-noise performance, the peak-to-peak noise of the input signal and reference must be less than 50μV.

Averaging

The noise of the A/D converter can be compensated by averaging the digital codes. By averaging conversion results, transition noise is reduced by a factor of $1/\sqrt{n}$, where n is the number of averages. For example, averaging four conversion results reduces the transition noise from $\pm 0.8\text{LSB}$ to $\pm 0.4\text{LSB}$. Averaging should only be used for input signals with frequencies near DC.

For AC signals, a digital filter can be used to low-pass filter and decimate the output codes. This configuration works in a similar manner to averaging; for every decimation by 2, the signal-to-noise ratio improves by 3dB.

DIGITAL INTERFACE

Signal Levels

The ADS8317 has a wide range of power-supply voltage. The A/D converter, as well as the digital interface circuit, is designed to accept and operate from 2.7V up to 5.5V. This voltage range accommodates different logic levels. When the ADS8317 power-supply voltage is in the range of 4.5V to 5.5V (5V logic level), the ADS8317 can be connected directly to another 5V, CMOS-integrated circuit. When the ADS8317 power-supply voltage is in the range of 2.7V to 3.6V (3V logic level), the ADS8317 can be connected directly to another 3.3V LVCMOS integrated circuit.

Serial Interface

The ADS8317 communicates with microprocessors and other digital systems via a synchronous 3-wire serial interface, as illustrated in the [Timing Information](#) section and [Timing Characteristics](#). The DCLOCK signal synchronizes the data transfer, with each bit being transmitted on the falling edge of DCLOCK. Most receiving systems capture the bitstream on the rising edge of DCLOCK. However, if the minimum hold time for D_{OUT} is acceptable, the system can use the falling edge of DCLOCK to capture each bit.

A falling \overline{CS} signal initiates the conversion and data transfer. The first 4.5 to 5.0 clock periods of the conversion cycle are used to sample the input signal.

After the fifth falling DCLOCK edge, D_{OUT} is enabled and outputs a low value for one clock period. For the next 16 DCLOCK periods, D_{OUT} outputs the conversion result, most significant bit first. After the least significant bit (B0) has been output, subsequent clocks repeat the output data, but in a least significant bit first format.

After the most significant bit (B15) has been repeated, D_{OUT} will 3-state. Subsequent clocks have no effect on the converter. A new conversion is initiated only when CS has been taken high and returned low.

Data Format

The output data from the ADS8317 are in binary twos complement format, as shown in [Table 1](#) and [Figure 44](#). The table and figure represent the ideal output code for the given input voltage and do not include the effects of offset, gain error, or noise.

Table 1. Ideal Input Voltages and Output Codes

DESCRIPTION	ANALOG VALUE	DIGITAL OUTPUT BINARY TWOS COMPLEMENT	
		Binary Code	Hex Code
Full-scale range	$2 \times V_{REF}$		
Least significant bit (LSB)	$2 \times V_{REF}/65536$		
+Full scale	$+V_{REF} - 1 \text{ LSB}$	0111 1111 1111 1111	7FFF
Midscale	0V	0000 0000 0000 0000	0000
Midscale – 1 LSB	$0V - 1 \text{ LSB}$	1111 1111 1111 1111	FFFF
–Full scale	$-V_{REF}$	1000 0000 0000 0000	8000

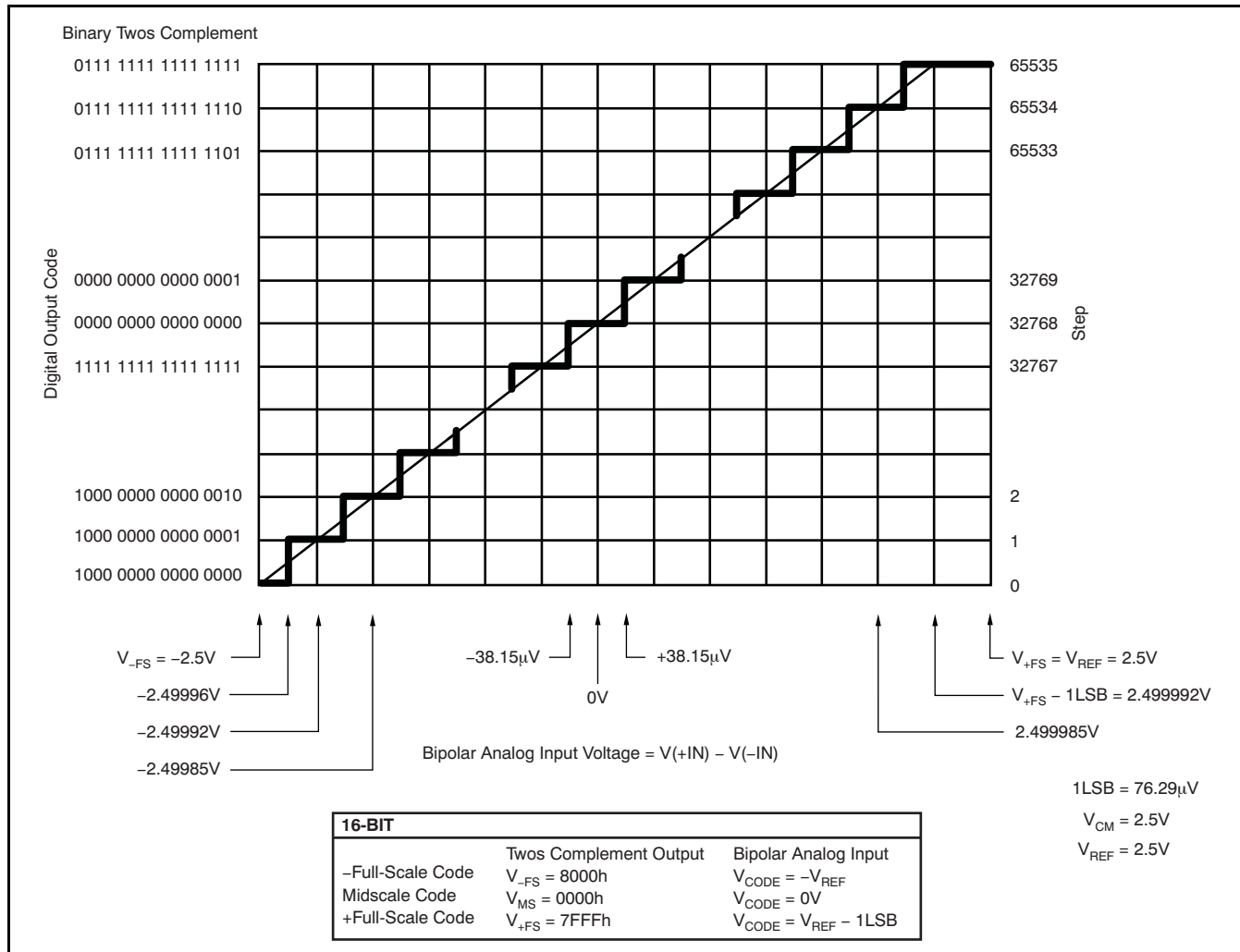

Figure 44. Ideal Conversion Characteristics (Conditions: $V_{CM} = 2.5V$, $V_{REF} = 2.5V$)

POWER DISSIPATION

The architecture of the converter, the semiconductor fabrication process, and a careful design allow the ADS8317 to convert at up to a 250kHz rate while requiring very little power. However, for the absolute lowest power dissipation, there are several things to keep in mind.

The power dissipation of the ADS8317 scales directly with conversion rate. Therefore, the first step to achieving the lowest power dissipation is to find the lowest conversion rate that satisfies the system requirements.

In addition, the ADS8317 goes into Power-Down mode under two conditions: when the conversion is complete and whenever \overline{CS} is high (see the Timing Characteristics section). Ideally, each conversion should occur as quickly as possible, preferably at a 6.0MHz clock rate. This way, the converter spends the longest possible time in power-down mode. This is very important because the converter not only uses power on each DCLOCK transition (as is typical for digital CMOS components), but also uses some current for the analog circuitry, such as the comparator. The analog section dissipates power continuously until power-down mode is entered.

Figure 9 and Figure 27 illustrate the current consumption of the ADS8317 versus sample rate. For these graphs, the converter is clocked at maximum speed regardless of the sample rate. \overline{CS} is held high during the remaining sample period.

There is an important distinction between the power-down mode that is entered after a conversion is complete and the full power-down mode that is enabled when \overline{CS} is high. \overline{CS} low only shuts down the analog section. The digital section completely shuts down only when \overline{CS} is high. Thus, if \overline{CS} is left low at the end of a conversion, and the converter is continually clocked, the power consumption is not as low as when \overline{CS} is high.

Short Cycling

Another way to save power is to use the \overline{CS} signal to short-cycle the conversion. The ADS8317 places the latest data bit on the D_{OUT} line as it is generated; therefore, the converter can easily be *short-cycled*. This term means that the conversion can be terminated at any time. For example, if only 14 bits of the conversion result are needed, then the conversion can be terminated (by pulling \overline{CS} high) after the 14th bit has been clocked out.

This technique can also be used to lower the power dissipation (or to increase the conversion rate) in those applications where an analog signal is being monitored until some condition becomes true. For example, if the signal is outside a predetermined range, the full 16-bit conversion result may not be needed. If so, the conversion can be terminated after the first n bits, where n might be as low as 3 or 4. This technique results in lower power dissipation in both the converter and the rest of the system because they spend more time in power-down mode.

POWER-ON RESET

The ADS8317 bias circuit is self-starting. There may be a static current (approximately 1.5mA with $V_{DD} = 5V$) after power-on, unless the circuit is powered down. It is recommended to run a single test conversion (configured the same as any regular conversion) after the power supply reaches at least 2.4V to ensure the device is put into power-down mode.



LAYOUT

For optimum performance, care should be taken with the physical layout of the ADS8317 circuitry. This caution is particularly true if the reference voltage is low and/or the conversion rate is high. At a 250kHz conversion rate, the ADS8317 makes a bit decision every 167ns. That is, for each subsequent bit decision, the digital output must be updated with the results of the last bit decision, the capacitor array appropriately switched and charged, and the input to the comparator settled to a 16-bit level, all within one clock cycle.

The basic SAR architecture is sensitive to spikes on the power supply, reference, and ground connections that occur just prior to latching the comparator output. Thus, during any single conversion for an n -bit SAR converter, there are n windows in which large external transient voltages can easily affect the conversion result. Such spikes might originate from switching power supplies, digital logic, and high-power devices, to name a few potential sources. This particular source of error can be very difficult to track down if the glitch is almost synchronous to the converter DCLOCK signal because the phase difference between the glitch and DCLOCK changes with time and temperature, causing sporadic misoperation.

With these considerations in mind, power to the ADS8317 should be clean and well-bypassed. A 0.1 μ F ceramic bypass capacitor should be placed as close as possible to the ADS8317 package. In addition, a 1 μ F to 10 μ F capacitor and a 5 Ω or 10 Ω series resistor may be used to low-pass filter a noisy supply.

The reference should be similarly bypassed with a 47 μ F capacitor. Again, a series resistor and large capacitor can be used to low-pass filter the reference voltage. If the reference voltage originates from an op amp, make sure that the op amp can drive the bypass capacitor without oscillation (the series resistor can help in this case). Keep in mind that while the ADS8317 draws very little current from the reference on average, there are still instantaneous current demands placed on the external input and reference circuitry.

Texas Instruments' [OPA365](#) op amp provides optimum performance for buffering the signal inputs; the [OPA350](#) can be used to effectively buffer the reference input.

Also, keep in mind that the ADS8317 offers no inherent rejection of noise or voltage variation in regards to the reference input. This characteristic is of particular concern when the reference input is tied to the power supply. Any noise and ripple from the supply appears directly in the digital results. While high-frequency noise can be filtered out, as described in the previous paragraph, voltage variation resulting from the line frequency (50Hz or 60Hz) can be difficult to remove.

The GND pin on the ADS8317 should be placed on a clean ground point. In many cases, this point is the analog ground. Avoid connecting the GND pin too close to the grounding point for a microprocessor, microcontroller, or digital signal processor. If needed, run a ground trace directly from the converter to the power-supply connection point. The ideal layout includes an analog ground plane for the converter and associated analog circuitry.

APPLICATION CIRCUITS

Figure 45 shows an example of a basic data acquisition system. The ADS8317 input range is connected to 2.5V or 4.096V. The 5Ω resistor and 1μF to 10μF capacitor filters the microcontroller noise

on the supply, as well as any high-frequency noise from the supply itself. The exact values should be picked such that the filter provides adequate rejection of noise. Operational amplifiers and voltage reference are connected to the analog power supply, AV_{DD}.

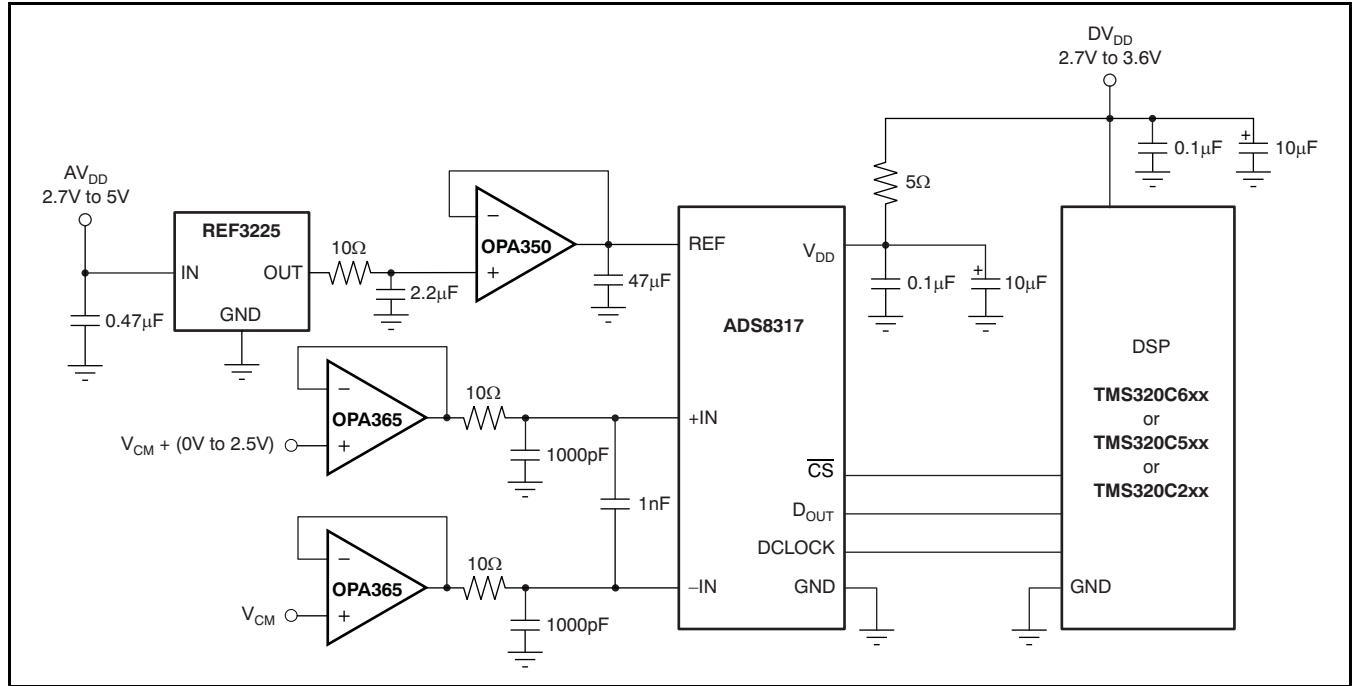

Figure 45. Example of a Basic Data Acquisition System



REVISION HISTORY

NOTE: Page numbers for previous revisions may differ from page numbers in the current version.

Changes from Revision C (June 2008) to Revision D	Page
• Changed SON-8 (DRB) package availability	1
• Deleted lead temperature specification	2
• Added missing mu symbol to High-level output voltage test condition	4
• Added missing mu symbol to Low-level output voltage test condition	4
• Changed X-axis unit from mA to μ A in Figure 10	11
• Changed Figure 38	17
• Changed Figure 39	17
• Changed Figure 40 title (typo)	17
• Added missing mu symbol to the value of the LSB, 76.3V	18
Changes from Revision B (May 2008) to Revision C	Page
• Changed 2nd timing diagram from the top in Figure 1	8

PACKAGING INFORMATION

Orderable part number	Status (1)	Material type (2)	Package Pins	Package qty Carrier	RoHS (3)	Lead finish/ Ball material (4)	MSL rating/ Peak reflow (5)	Op temp (°C)	Part marking (6)
ADS8317IBDGKR	Active	Production	VSSOP (DGK) 8	2500 LARGE T&R	Yes	Call TI	Level-2-260C-1 YEAR	-40 to 85	D17
ADS8317IBDGKR.A	Active	Production	VSSOP (DGK) 8	2500 LARGE T&R	Yes	Call TI	Level-2-260C-1 YEAR	-40 to 85	D17
ADS8317IBDGKT	Active	Production	VSSOP (DGK) 8	250 SMALL T&R	Yes	Call TI	Level-2-260C-1 YEAR	-40 to 85	D17
ADS8317IBDGKT.A	Active	Production	VSSOP (DGK) 8	250 SMALL T&R	Yes	Call TI	Level-2-260C-1 YEAR	-40 to 85	D17
ADS8317IBDRBR	Active	Production	SON (DRB) 8	3000 LARGE T&R	Yes	Call TI	Level-2-260C-1 YEAR	-40 to 85	D17
ADS8317IBDRBR.A	Active	Production	SON (DRB) 8	3000 LARGE T&R	Yes	Call TI	Level-2-260C-1 YEAR	-40 to 85	D17
ADS8317IBDRBT	Active	Production	SON (DRB) 8	250 SMALL T&R	Yes	Call TI	Level-2-260C-1 YEAR	-40 to 85	D17
ADS8317IBDRBT.A	Active	Production	SON (DRB) 8	250 SMALL T&R	Yes	Call TI	Level-2-260C-1 YEAR	-40 to 85	D17
ADS8317IDGKR	Active	Production	VSSOP (DGK) 8	2500 LARGE T&R	Yes	Call TI	Level-2-260C-1 YEAR	-40 to 85	D17
ADS8317IDGKR.A	Active	Production	VSSOP (DGK) 8	2500 LARGE T&R	Yes	Call TI	Level-2-260C-1 YEAR	-40 to 85	D17
ADS8317IDGKT	Active	Production	VSSOP (DGK) 8	250 SMALL T&R	Yes	Call TI	Level-2-260C-1 YEAR	-40 to 85	D17
ADS8317IDGKT.A	Active	Production	VSSOP (DGK) 8	250 SMALL T&R	Yes	Call TI	Level-2-260C-1 YEAR	-40 to 85	D17
ADS8317IDRBR	Active	Production	SON (DRB) 8	3000 LARGE T&R	Yes	Call TI	Level-2-260C-1 YEAR	-40 to 85	D17
ADS8317IDRBR.A	Active	Production	SON (DRB) 8	3000 LARGE T&R	Yes	Call TI	Level-2-260C-1 YEAR	-40 to 85	D17
ADS8317IDRBT	Active	Production	SON (DRB) 8	250 SMALL T&R	Yes	Call TI	Level-2-260C-1 YEAR	-40 to 85	D17
ADS8317IDRBT.A	Active	Production	SON (DRB) 8	250 SMALL T&R	Yes	Call TI	Level-2-260C-1 YEAR	-40 to 85	D17

(1) **Status:** For more details on status, see our [product life cycle](#).

(2) **Material type:** When designated, preproduction parts are prototypes/experimental devices, and are not yet approved or released for full production. Testing and final process, including without limitation quality assurance, reliability performance testing, and/or process qualification, may not yet be complete, and this item is subject to further changes or possible discontinuation. If available for ordering, purchases will be subject to an additional waiver at checkout, and are intended for early internal evaluation purposes only. These items are sold without warranties of any kind.

(3) **RoHS values:** Yes, No, RoHS Exempt. See the [TI RoHS Statement](#) for additional information and value definition.

(4) **Lead finish/Ball material:** Parts may have multiple material finish options. Finish options are separated by a vertical ruled line. Lead finish/Ball material values may wrap to two lines if the finish value exceeds the maximum column width.

(5) **MSL rating/Peak reflow:** The moisture sensitivity level ratings and peak solder (reflow) temperatures. In the event that a part has multiple moisture sensitivity ratings, only the lowest level per JEDEC standards is shown. Refer to the shipping label for the actual reflow temperature that will be used to mount the part to the printed circuit board.

(6) Part marking: There may be an additional marking, which relates to the logo, the lot trace code information, or the environmental category of the part.

Multiple part markings will be inside parentheses. Only one part marking contained in parentheses and separated by a "-" will appear on a part. If a line is indented then it is a continuation of the previous line and the two combined represent the entire part marking for that device.

Important Information and Disclaimer:The information provided on this page represents TI's knowledge and belief as of the date that it is provided. TI bases its knowledge and belief on information provided by third parties, and makes no representation or warranty as to the accuracy of such information. Efforts are underway to better integrate information from third parties. TI has taken and continues to take reasonable steps to provide representative and accurate information but may not have conducted destructive testing or chemical analysis on incoming materials and chemicals. TI and TI suppliers consider certain information to be proprietary, and thus CAS numbers and other limited information may not be available for release.

In no event shall TI's liability arising out of such information exceed the total purchase price of the TI part(s) at issue in this document sold by TI to Customer on an annual basis.

TAPE AND REEL INFORMATION

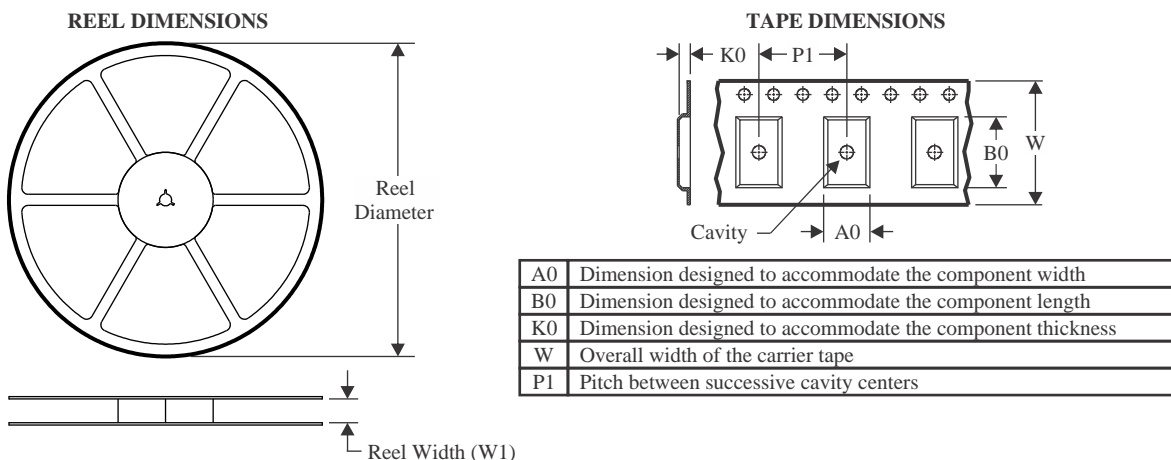

QUADRANT ASSIGNMENTS FOR PIN 1 ORIENTATION IN TAPE

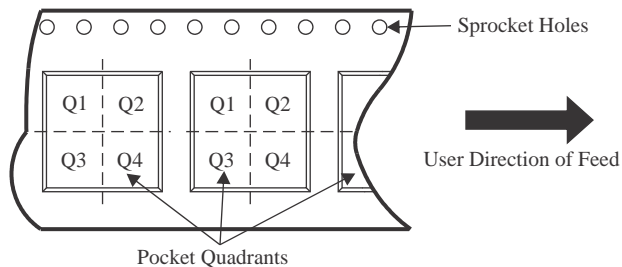

*All dimensions are nominal

Device	Package Type	Package Drawing	Pins	SPQ	Reel Diameter (mm)	Reel Width W1 (mm)	A0 (mm)	B0 (mm)	K0 (mm)	P1 (mm)	W (mm)	Pin1 Quadrant
ADS8317IBDGKR	VSSOP	DGK	8	2500	330.0	12.4	5.3	3.4	1.4	8.0	12.0	Q1
ADS8317IBDGKT	VSSOP	DGK	8	250	180.0	12.4	5.3	3.4	1.4	8.0	12.0	Q1
ADS8317IBDRBR	SON	DRB	8	3000	330.0	12.4	3.3	3.3	1.1	8.0	12.0	Q2
ADS8317IBDRBT	SON	DRB	8	250	180.0	12.4	3.3	3.3	1.1	8.0	12.0	Q2
ADS8317IDGKR	VSSOP	DGK	8	2500	330.0	12.4	5.3	3.4	1.4	8.0	12.0	Q1
ADS8317IDGKT	VSSOP	DGK	8	250	180.0	12.4	5.3	3.4	1.4	8.0	12.0	Q1
ADS8317IDRBR	SON	DRB	8	3000	330.0	12.4	3.3	3.3	1.1	8.0	12.0	Q2
ADS8317IDRBT	SON	DRB	8	250	180.0	12.4	3.3	3.3	1.1	8.0	12.0	Q2

TAPE AND REEL BOX DIMENSIONS

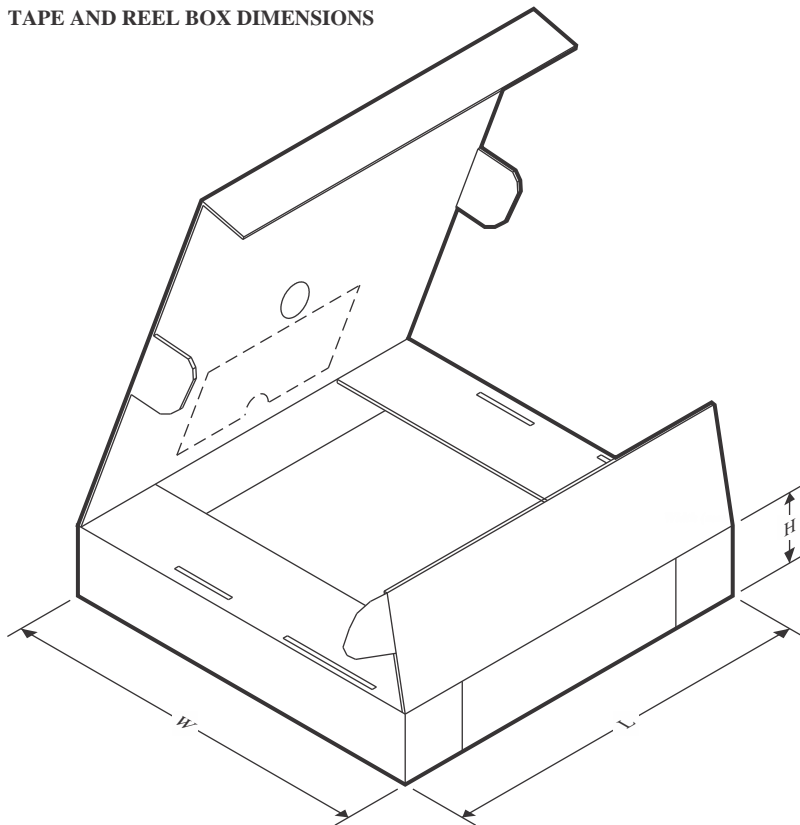

*All dimensions are nominal

Device	Package Type	Package Drawing	Pins	SPQ	Length (mm)	Width (mm)	Height (mm)
ADS8317IBDGKR	VSSOP	DGK	8	2500	350.0	350.0	43.0
ADS8317IBDGKT	VSSOP	DGK	8	250	210.0	185.0	35.0
ADS8317IBDRBR	SON	DRB	8	3000	350.0	350.0	43.0
ADS8317IBDRBT	SON	DRB	8	250	210.0	185.0	35.0
ADS8317IDGKR	VSSOP	DGK	8	2500	350.0	350.0	43.0
ADS8317IDGKT	VSSOP	DGK	8	250	210.0	185.0	35.0
ADS8317IDRBR	SON	DRB	8	3000	350.0	350.0	43.0
ADS8317IDRBT	SON	DRB	8	250	210.0	185.0	35.0

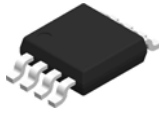

DGK0008A

PACKAGE OUTLINE

VSSOP - 1.1 mm max height

SMALL OUTLINE PACKAGE

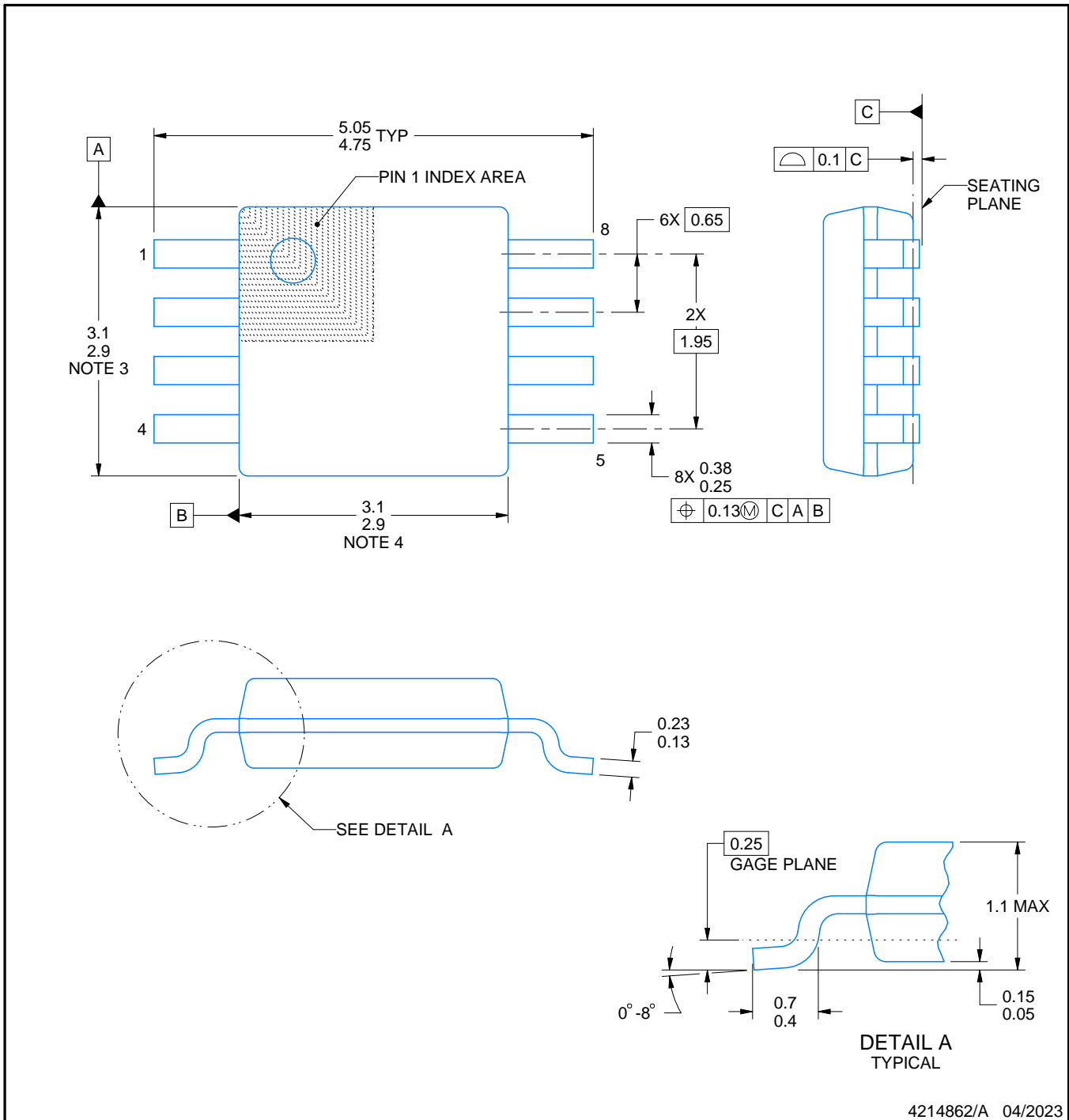

NOTES:

PowerPAD is a trademark of Texas Instruments.

1. All linear dimensions are in millimeters. Any dimensions in parenthesis are for reference only. Dimensioning and tolerancing per ASME Y14.5M.
2. This drawing is subject to change without notice.
3. This dimension does not include mold flash, protrusions, or gate burrs. Mold flash, protrusions, or gate burrs shall not exceed 0.15 mm per side.
4. This dimension does not include interlead flash. Interlead flash shall not exceed 0.25 mm per side.
5. Reference JEDEC registration MO-187.

EXAMPLE BOARD LAYOUT

DGK0008A

TM VSSOP - 1.1 mm max height

SMALL OUTLINE PACKAGE

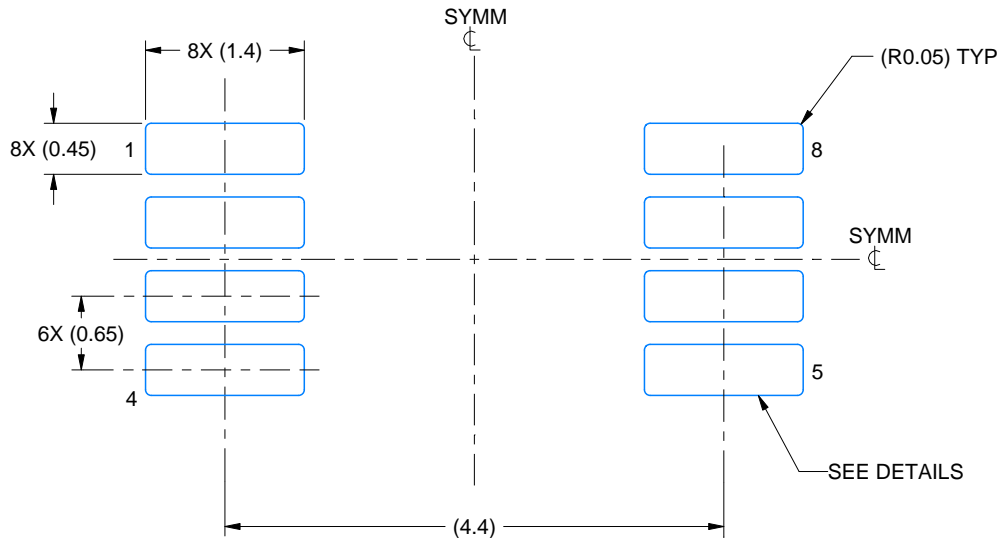

LAND PATTERN EXAMPLE
EXPOSED METAL SHOWN
SCALE: 15X

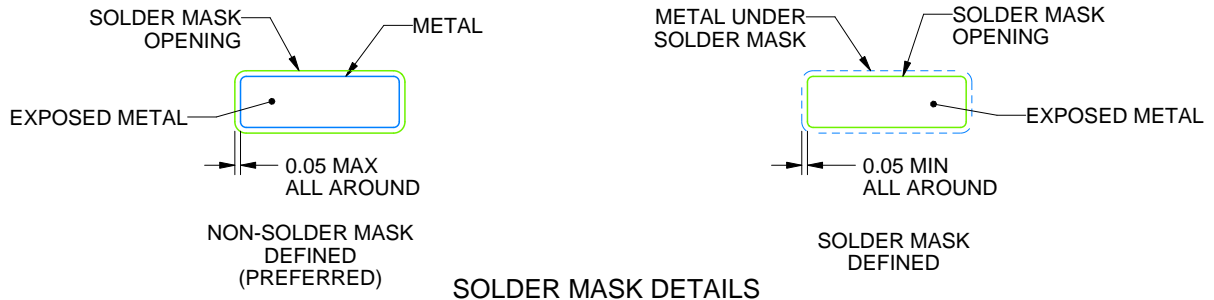

SOLDER MASK DETAILS

4214862/A 04/2023

NOTES: (continued)

- 6. Publication IPC-7351 may have alternate designs.
- 7. Solder mask tolerances between and around signal pads can vary based on board fabrication site.
- 8. Vias are optional depending on application, refer to device data sheet. If any vias are implemented, refer to their locations shown on this view. It is recommended that vias under paste be filled, plugged or tented.
- 9. Size of metal pad may vary due to creepage requirement.

EXAMPLE STENCIL DESIGN

DGK0008A

TM VSSOP - 1.1 mm max height

SMALL OUTLINE PACKAGE

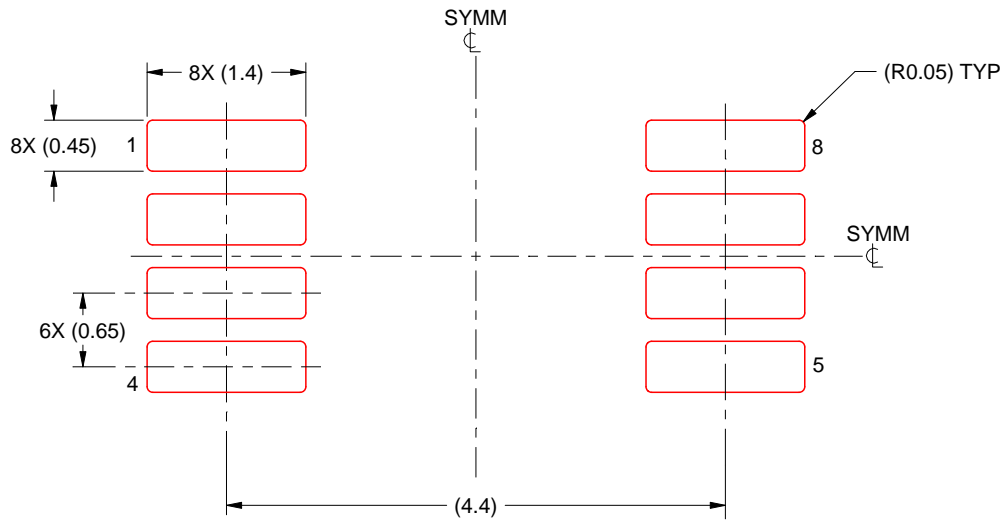

SOLDER PASTE EXAMPLE
SCALE: 15X

4214862/A 04/2023

NOTES: (continued)

11. Laser cutting apertures with trapezoidal walls and rounded corners may offer better paste release. IPC-7525 may have alternate design recommendations.
12. Board assembly site may have different recommendations for stencil design.

GENERIC PACKAGE VIEW

DRB 8

VSON - 1 mm max height

PLASTIC SMALL OUTLINE - NO LEAD



Images above are just a representation of the package family, actual package may vary.
Refer to the product data sheet for package details.

4203482/L



DRB0008B

PACKAGE OUTLINE

VSON - 1 mm max height

PLASTIC SMALL OUTLINE - NO LEAD

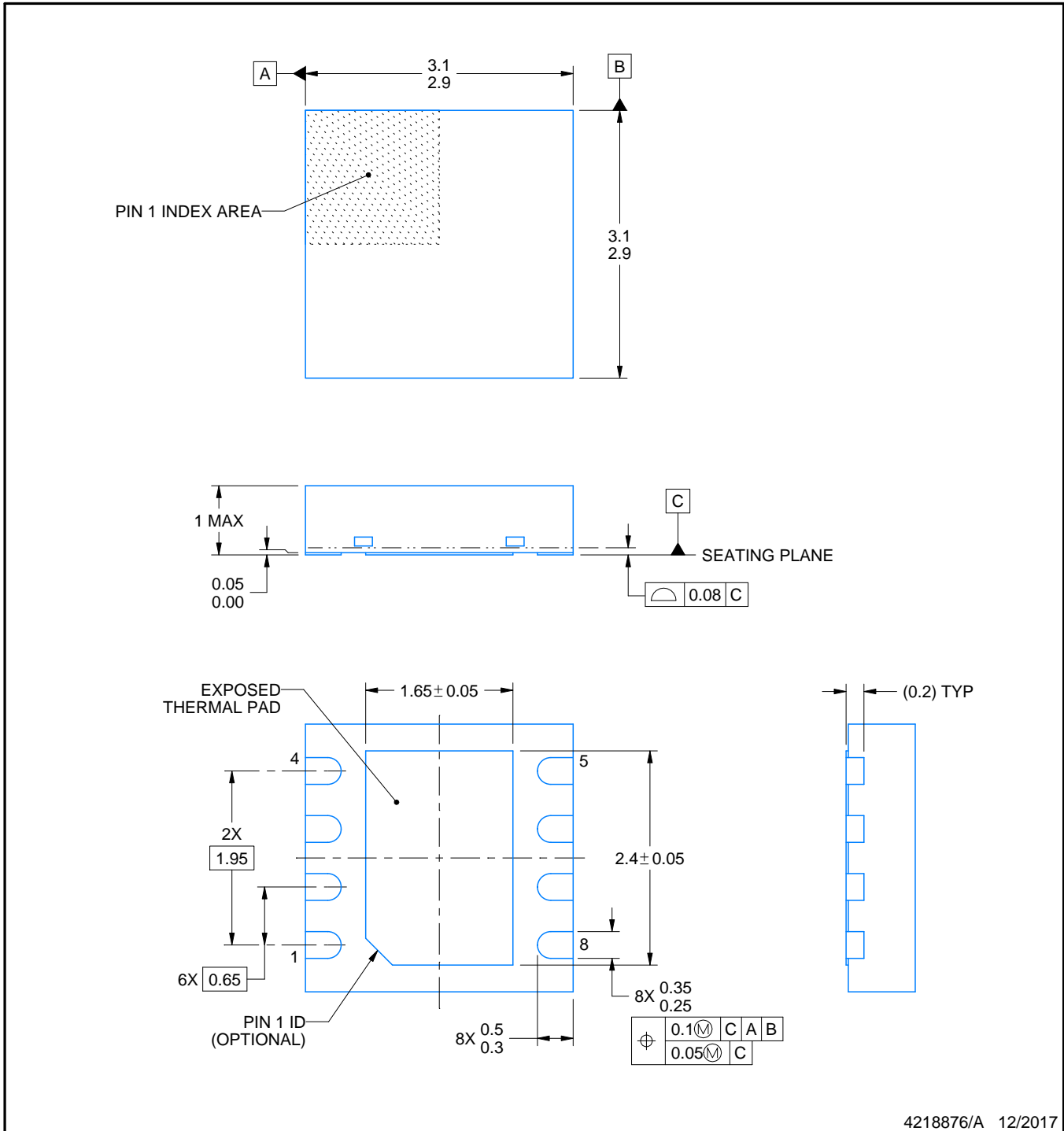

4218876/A 12/2017

NOTES:

1. All linear dimensions are in millimeters. Any dimensions in parenthesis are for reference only. Dimensioning and tolerancing per ASME Y14.5M.
2. This drawing is subject to change without notice.
3. The package thermal pad must be soldered to the printed circuit board for thermal and mechanical performance.

EXAMPLE STENCIL DESIGN

DRB0008B

VSON - 1 mm max height

PLASTIC SMALL OUTLINE - NO LEAD

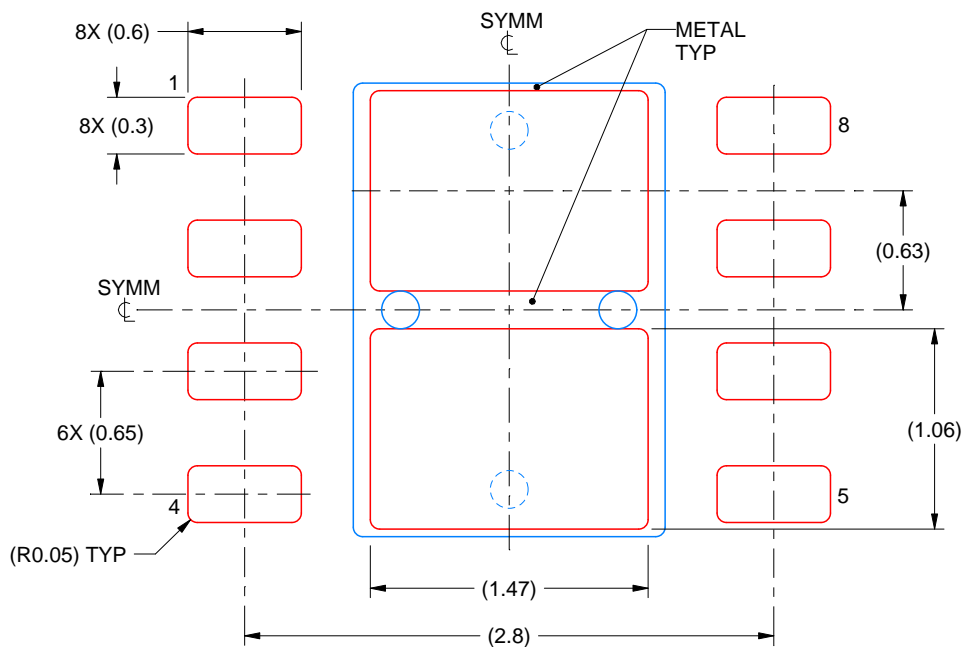

SOLDER PASTE EXAMPLE
 BASED ON 0.125 mm THICK STENCIL
 EXPOSED PAD
 81% PRINTED SOLDER COVERAGE BY AREA
 SCALE:25X

4218876/A 12/2017

NOTES: (continued)

6. Laser cutting apertures with trapezoidal walls and rounded corners may offer better paste release. IPC-7525 may have alternate design recommendations.

IMPORTANT NOTICE AND DISCLAIMER

TI PROVIDES TECHNICAL AND RELIABILITY DATA (INCLUDING DATASHEETS), DESIGN RESOURCES (INCLUDING REFERENCE DESIGNS), APPLICATION OR OTHER DESIGN ADVICE, WEB TOOLS, SAFETY INFORMATION, AND OTHER RESOURCES "AS IS" AND WITH ALL FAULTS, AND DISCLAIMS ALL WARRANTIES, EXPRESS AND IMPLIED, INCLUDING WITHOUT LIMITATION ANY IMPLIED WARRANTIES OF MERCHANTABILITY, FITNESS FOR A PARTICULAR PURPOSE OR NON-INFRINGEMENT OF THIRD PARTY INTELLECTUAL PROPERTY RIGHTS.

These resources are intended for skilled developers designing with TI products. You are solely responsible for (1) selecting the appropriate TI products for your application, (2) designing, validating and testing your application, and (3) ensuring your application meets applicable standards, and any other safety, security, regulatory or other requirements.

These resources are subject to change without notice. TI grants you permission to use these resources only for development of an application that uses the TI products described in the resource. Other reproduction and display of these resources is prohibited. No license is granted to any other TI intellectual property right or to any third party intellectual property right. TI disclaims responsibility for, and you fully indemnify TI and its representatives against any claims, damages, costs, losses, and liabilities arising out of your use of these resources.

TI's products are provided subject to [TI's Terms of Sale](#), [TI's General Quality Guidelines](#), or other applicable terms available either on [ti.com](#) or provided in conjunction with such TI products. TI's provision of these resources does not expand or otherwise alter TI's applicable warranties or warranty disclaimers for TI products. Unless TI explicitly designates a product as custom or customer-specified, TI products are standard, catalog, general purpose devices.

TI objects to and rejects any additional or different terms you may propose.

Copyright © 2025, Texas Instruments Incorporated

Last updated 10/2025

OUR CERTIFICATE

DiGi provide top-quality products and perfect service for customer worldwide through standardization, technological innovation and continuous improvement. DiGi through third-party certification, we strictly control the quality of products and services. Welcome your RFQ to

Email: Info@DiGi-Electronics.com



Tel: +00 852-30501935

RFQ Email: Info@DiGi-Electronics.com

DiGi is a global authorized distributor of electronic components.