

ADS8411IPFBT Datasheet

www.digi-electronics.com

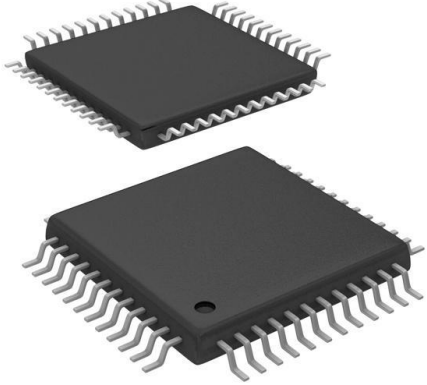

ADS8411IPFBT

<https://www.DiGi-Electronics.com>

DiGi Electronics Part Number	ADS8411IPFBT-DG
Manufacturer	Texas Instruments
Manufacturer Product Number	ADS8411IPFBT
Description	IC ADC 16BIT SAR 48TQFP
Detailed Description	16 Bit Analog to Digital Converter 1 Input 1 SAR 48-TQFP (7x7)



Tel: +00 852-30501935

RFQ Email: Info@DiGi-Electronics.com

DiGi is a global authorized distributor of electronic components.

Purchase and inquiry

Manufacturer Product Number:

ADS8411IPFBT

Series:

microPOWER™

Number of Bits:

16

Number of Inputs:

1

Data Interface:

Parallel

Ratio - S/H:ADC:

1:1

Architecture:

SAR

Voltage - Supply, Analog:

5V

Features:

-

Package / Case:

48-TQFP

Mounting Type:

Surface Mount

Manufacturer:

Texas Instruments

Product Status:

Active

Sampling Rate (Per Second):

2M

Input Type:

Pseudo-Differential, Single Ended

Configuration:

S/H-ADC

Number of A/D Converters:

1

Reference Type:

External, Internal

Voltage - Supply, Digital:

2.7V ~ 5.25V

Operating Temperature:

-40°C ~ 85°C

Supplier Device Package:

48-TQFP (7x7)

Base Product Number:

ADS8411

Environmental & Export classification

RoHS Status:

ROHS3 Compliant

REACH Status:

REACH Unaffected

HTSUS:

8542.39.0001

Moisture Sensitivity Level (MSL):

2 (1 Year)

ECCN:

EAR99

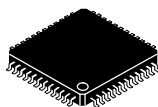

16-BIT, 2 MSPS, UNIPOLAR INPUT, MICRO POWER SAMPLING ANALOG-TO-DIGITAL CONVERTER WITH PARALLEL INTERFACE AND REFERENCE

FEATURES

- 2-MHz Sample Rate
- 16-Bit NMC Ensured Over Temperature
- Zero Latency
- Unipolar Single-Ended Input Range:
0 V to V_{ref}
- Onboard Reference
- Onboard Reference Buffer
- High-Speed Parallel Interface
- Power Dissipation: 175 mW at 2 MHz Typ
- Wide Digital Supply
- 8-/16-Bit Bus Transfer
- 48-Pin TQFP Package
- ESD Sensitive – HBM Capability of 500 V,
1000 V at All Input Pins

APPLICATIONS

- DWDM
- Instrumentation
- High-Speed, High-Resolution, Zero Latency
Data Acquisition Systems
- Transducer Interface
- Medical Instruments
- Communication

DESCRIPTION

The ADS8411 is a 16-bit, 2 MHz A/D converter with an internal 4.096-V reference. The device includes a 16-bit capacitor-based SAR A/D converter with inherent sample and hold. The ADS8411 offers a full 16-bit interface and an 8-bit option where data is read using two 8-bit read cycles.

The ADS8411 has a unipolar single-ended input. It is available in a 48-lead TQFP package and is characterized over the industrial -40°C to 85°C temperature range.

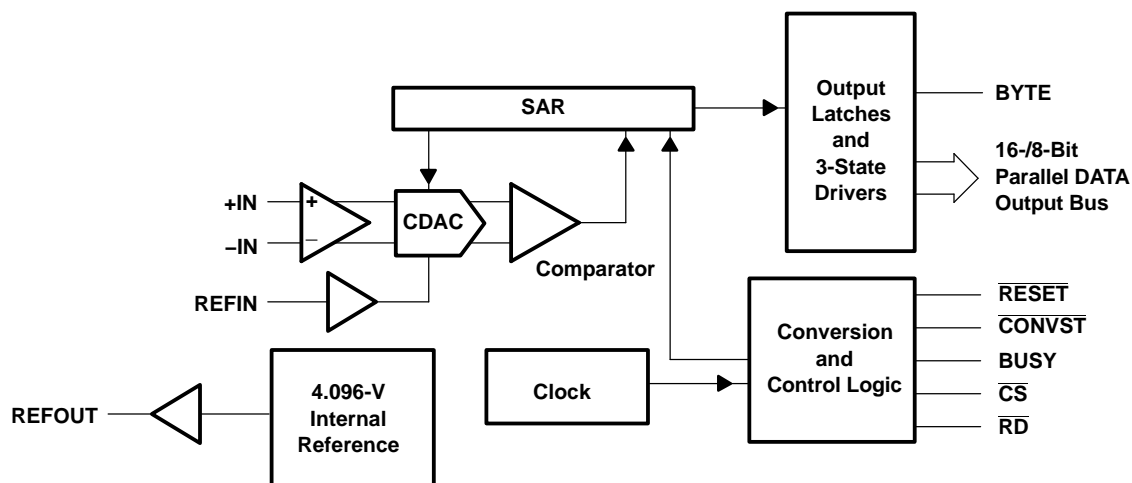

Please be aware that an important notice concerning availability, standard warranty, and use in critical applications of Texas Instruments semiconductor products and disclaimers thereto appears at the end of this data sheet.

 This integrated circuit can be damaged by ESD. Texas Instruments recommends that all integrated circuits be handled with appropriate precautions. Failure to observe proper handling and installation procedures can cause damage.

ESD damage can range from subtle performance degradation to complete device failure. Precision integrated circuits may be more susceptible to damage because very small parametric changes could cause the device not to meet its published specifications.

ORDERING INFORMATION⁽¹⁾

MODEL	MAXIMUM INTEGRAL LINEARITY (LSB)	MAXIMUM DIFFERENTIAL LINEARITY (LSB)	NO MISSING CODES RESOLUTION (BIT)	PACKAGE TYPE	PACKAGE DESIGNATOR	TEMPERATURE RANGE	ORDERING INFORMATION	TRANSPORT MEDIA QUANTITY
ADS8411I	-6 ~ 6	-2~3	15	48 Pin TQFP	PFB	-40°C to 85°C	ADS8411IPFBT	Tape and reel 250
							ADS8411IPFBR	Tape and reel 1000
ADS8411IB	-2.5 ~ 2.5	-1~2	16	48 Pin TQFP	PFB	-40°C to 85°C	ADS8411IBPFBT	Tape and reel 250
							ADS8411IBPFBR	Tape and reel 1000

(1) For the most current specifications and package information, refer to our website at www.ti.com.

ABSOLUTE MAXIMUM RATINGS

over operating free-air temperature range unless otherwise noted⁽¹⁾

		UNIT
Voltage	+IN to AGND	-0.4 V to +VA + 0.1 V
	-IN to AGND	-0.4 V to 0.5 V
Voltage range	+VA to AGND	-0.3 V to 7 V
	+VBD to BDGND	-0.3 V to 7 V
	+VA to +VBD	-0.3 V to 2.55 V
Digital input voltage to BDGND		-0.3 V to +VBD + 0.3 V
Digital output voltage to BDGND		-0.3 V to +VBD + 0.3 V
T _A	Operating free-air temperature range	-40°C to 85°C
T _{stg}	Storage temperature range	-65°C to 150°C
Junction temperature (T _J max)		150°C
TQFP package	Power dissipation	(T _J Max - T _A)/θ _{JA}
	θ _{JA} thermal impedance	86°C/W
Lead temperature, soldering	Vapor phase (60 sec)	215°C
	Infrared (15 sec)	220°C

(1) Stresses beyond those listed under *absolute maximum ratings* may cause permanent damage to the device. These are stress ratings only, and functional operation of the device at these or any other conditions beyond those indicated under *recommended operating conditions* is not implied. Exposure to absolute-maximum-rated conditions for extended periods may affect device reliability.

SPECIFICATIONS
 $T_A = -40^{\circ}\text{C}$ to 85°C , $+V_A = 5\text{ V}$, $+V_{BD} = 3\text{ V}$ or 5 V , $V_{\text{ref}} = 4.096\text{ V}$, $f_{\text{SAMPLE}} = 2\text{ MHz}$ (unless otherwise noted)

PARAMETER		TEST CONDITIONS	MIN	TYP	MAX	UNIT
ANALOG INPUT						
Full-scale input voltage ⁽¹⁾		+IN – (–IN)	0		V_{ref}	V
Absolute input voltage		+IN	–0.2		$V_{\text{ref}} + 0.2$	V
		–IN	–0.2		0.2	
Input capacitance				25		pF
Input leakage current				0.5		nA
SYSTEM PERFORMANCE						
Resolution				16		Bits
No missing codes		ADS8411I	15			Bits
		ADS8411IB	16			
INL	Integral linearity ⁽²⁾⁽³⁾	ADS8411I	–6	± 4	6	LSB
		ADS8411IB	–2.5	± 1.5	2.5	
DNL	Differential linearity	ADS8411I	–2	± 1	3	LSB
		ADS8411IB	–1	± 0.8	2	
E_O	Offset error ⁽⁴⁾	ADS8411I	–1.5	± 0.5	1.5	mV
		ADS8411IB	–0.75	± 0.25	0.75	mV
E_G	Gain error ⁽⁴⁾⁽⁵⁾	ADS8411I	–0.15		0.15	%FS
		ADS8411IB	–0.098		0.098	
Noise				60		$\mu\text{V RMS}$
PSRR	DC Power supply rejection ratio	At FFFFh output code, $+V_A = 4.75\text{ V}$ to 5.25 V , $V_{\text{ref}} = 4.096\text{ V}$ ⁽⁴⁾		2		LSB
SAMPLING DYNAMICS						
Conversion time			340		400	ns
Acquisition time			100			ns
Throughput rate					2	MHz
Aperture delay				2		ns
Aperture jitter				25		ps
Step response				100		ns
Overvoltage recovery				100		ns
DYNAMIC CHARACTERISTICS						
THD	Total harmonic distortion ⁽⁶⁾	$V_{\text{IN}} = 4 V_{\text{pp}}$ at 100 kHz		–90		dB
		$V_{\text{IN}} = 4 V_{\text{pp}}$ at 500 kHz		–88.5		
SNR	Signal-to-noise ratio	$V_{\text{IN}} = 4 V_{\text{pp}}$ at 100 kHz		86		dB
SINAD	Signal-to-noise + distortion	$V_{\text{IN}} = 4 V_{\text{pp}}$ at 100 kHz		85		dB
SFDR	Spurious free dynamic range	$V_{\text{IN}} = 4 V_{\text{pp}}$ at 100 kHz		90		dB
		$V_{\text{IN}} = 4 V_{\text{pp}}$ at 500 kHz		88		
–3dB Small signal bandwidth				5		MHz
EXTERNAL VOLTAGE REFERENCE INPUT						
Reference voltage at REFIN, V_{ref}			3.9	4.096	4.2	V
Reference resistance ⁽⁷⁾				500		k Ω

(1) Ideal input span, does not include gain or offset error.

(2) LSB means least significant bit

(3) This is endpoint INL, not best fit.

(4) Measured relative to an ideal full-scale input [+IN – (–IN)] of 4.096 V

(5) This specification does not include the internal reference voltage error and drift.

(6) Calculated on the first nine harmonics of the input frequency

(7) Can vary $\pm 20\%$

SPECIFICATIONS (continued)

$T_A = -40^{\circ}\text{C}$ to 85°C , $+VA = 5\text{ V}$, $+VBD = 3\text{ V}$ or 5 V , $V_{\text{ref}} = 4.096\text{ V}$, $f_{\text{SAMPLE}} = 2\text{ MHz}$ (unless otherwise noted)

PARAMETER		TEST CONDITIONS	MIN	TYP	MAX	UNIT
INTERNAL REFERENCE OUTPUT						
	Internal reference start-up time	From 95% (+VA), with 1 μF storage capacitor			120	ms
V_{ref}	Reference voltage	IOUT = 0	4.065	4.096	4.13	V
	Source current	Static load			10	μA
	Line regulation	+VA = 4.75 ~ 5.25 V		0.6		mV
	Drift	IOUT = 0		36		PPM/ $^{\circ}\text{C}$
DIGITAL INPUT/OUTPUT						
	Logic family — CMOS					
V_{IH}	High level input voltage	$I_{\text{IH}} = 5\ \mu\text{A}$	+VBD – 1	+VBD + 0.3		V
V_{IL}	Low level input voltage	$I_{\text{IL}} = 5\ \mu\text{A}$	–0.3	0.8		
V_{OH}	High level output voltage	$I_{\text{OH}} = 2\text{ TTL loads}$	+VBD – 0.6	+VBD		
V_{OL}	Low level output voltage	$I_{\text{OL}} = 2\text{ TTL loads}$	0	0.4		
	Data format — straight binary					
POWER SUPPLY REQUIREMENTS						
Power supply voltage	+VBD		2.7	3	5.25	V
	+VA		4.75	5	5.25	V
	+VA Supply current ⁽⁸⁾	$f_s = 2\text{ MHz}$		35	38	mA
P_D	Power dissipation ⁽⁸⁾	$f_s = 2\text{ MHz}$		175	190	mW
TEMPERATURE RANGE						
T_A	Operating free-air		–40		85	$^{\circ}\text{C}$

(8) This includes only +VA current. +VBD current is typically 1 mA with 5-pF load capacitance on output pins.

TIMING CHARACTERISTICS

All specifications typical at -40°C to 85°C , $+V_A = +V_{BD} = 5\text{ V}$ ⁽¹⁾⁽²⁾⁽³⁾

PARAMETER		MIN	TYP	MAX	UNIT
t_{CONV}	Conversion time	340		400	ns
t_{ACQ}	Acquisition time	100			ns
t_{pd1}	$\overline{\text{CONVST}}$ low to BUSY high		30		ns
t_{pd2}	Propagation delay time, end of conversion to BUSY low		5		ns
t_{w1}	Pulse duration, $\overline{\text{CONVST}}$ low	20			ns
t_{su1}	Setup time, $\overline{\text{CS}}$ low to $\overline{\text{CONVST}}$ low	0			ns
t_{w2}	Pulse duration, $\overline{\text{CONVST}}$ high	20			ns
	$\overline{\text{CONVST}}$ falling edge jitter			10	ps
t_{w3}	Pulse duration, BUSY signal low	Min(t_{ACQ})			ns
t_{w4}	Pulse duration, BUSY signal high		370		ns
t_{h1}	Hold time, first data bus data transition ($\overline{\text{RD}}$ low, or $\overline{\text{CS}}$ low for read cycle, or BYTE input changes) after $\overline{\text{CONVST}}$ low	40			ns
t_{d1}	Delay time, $\overline{\text{CS}}$ low to $\overline{\text{RD}}$ low (or BUSY low to RD low)	0			ns
t_{su2}	Setup time, $\overline{\text{RD}}$ high to $\overline{\text{CS}}$ high	0			ns
t_{w5}	Pulse duration, $\overline{\text{RD}}$ low	50			ns
t_{en}	Enable time, $\overline{\text{RD}}$ low (or $\overline{\text{CS}}$ low for read cycle) to data valid			20	ns
t_{d2}	Delay time, data hold from $\overline{\text{RD}}$ high	0			ns
t_{d3}	Delay time, BYTE rising edge or falling edge to data valid	2		20	ns
t_{w6}	Pulse duration, $\overline{\text{RD}}$ high	20			ns
t_{w7}	Pulse duration, $\overline{\text{CS}}$ high	20			ns
t_{h2}	Hold time, last $\overline{\text{RD}}$ (or $\overline{\text{CS}}$ for read cycle) rising edge to $\overline{\text{CONVST}}$ falling edge	50			ns
t_{su3}	Setup time, BYTE transition to $\overline{\text{RD}}$ falling edge	0			ns
t_{h3}	Hold time, BYTE transition to $\overline{\text{RD}}$ falling edge	0			ns
t_{dis}	Disable time, $\overline{\text{RD}}$ high ($\overline{\text{CS}}$ high for read cycle) to 3-stated data bus			20	ns
t_{d5}	Delay time, end of conversion to MSB data valid			10	ns
t_{su4}	Byte transition setup time, from BYTE transition to next BYTE transition	50			ns
t_{d6}	Delay time, $\overline{\text{CS}}$ rising edge to BUSY falling edge	50			ns
t_{d7}	Delay time, BUSY falling edge to $\overline{\text{CS}}$ rising edge	50			ns
$t_{\text{su(AB)}}$	Setup time, from the falling edge of $\overline{\text{CONVST}}$ (used to start the valid conversion) to the next falling edge of $\overline{\text{CONVST}}$ (when $\overline{\text{CS}} = 0$ and $\overline{\text{CONVST}}$ used to abort) or to the next falling edge of $\overline{\text{CS}}$ (when $\overline{\text{CS}}$ is used to abort)	60		340	ns
t_{su5}	Setup time, falling edge of $\overline{\text{CONVST}}$ to read valid data (MSB) from current conversion	MAX(t_{CONV}) + MAX(t_{d5})			ns
t_{h4}	Hold time, data (MSB) from previous conversion hold valid from falling edge of $\overline{\text{CONVST}}$	MIN(t_{CONV})			ns

- (1) All input signals are specified with $t_r = t_f = 5\text{ ns}$ (10% to 90% of $+V_{BD}$) and timed from a voltage level of $(V_{\text{IL}} + V_{\text{IH}})/2$.
- (2) See timing diagrams.
- (3) All timings are measured with 20 pF equivalent loads on all data bits and BUSY pins.

TIMING CHARACTERISTICS

All specifications typical at -40°C to 85°C , $+V_A = 5\text{ V}$, $+V_{BD} = 3\text{ V}^{(1)(2)(3)}$

PARAMETER	MIN	TYP	MAX	UNIT
t_{CONV} Conversion time	340		400	ns
t_{ACQ} Acquisition time	100			ns
t_{pd1} $\overline{\text{CONVST}}$ low to conversion started (BUSY high)		40		ns
t_{pd2} Propagation delay time, end of conversion to BUSY low		10		ns
t_{w1} Pulse duration, $\overline{\text{CONVST}}$ low	20			ns
t_{su1} Setup time, $\overline{\text{CS}}$ low to $\overline{\text{CONVST}}$ low	0			ns
t_{w2} Pulse duration, $\overline{\text{CONVST}}$ high	20			ns
$\overline{\text{CONVST}}$ falling edge jitter			10	ps
t_{w3} Pulse duration, BUSY signal low	Min(t_{ACQ})			ns
t_{w4} Pulse duration, BUSY signal high		370		ns
t_{h1} Hold time, first data bus transition ($\overline{\text{RD}}$ low, or $\overline{\text{CS}}$ low for read cycle, or BYTE input changes) after $\overline{\text{CONVST}}$ low	40			ns
t_{d1} Delay time, $\overline{\text{CS}}$ low to $\overline{\text{RD}}$ low (or BUSY low to $\overline{\text{RD}}$ low)	0			ns
t_{su2} Setup time, $\overline{\text{RD}}$ high to $\overline{\text{CS}}$ high	0			ns
t_{w5} Pulse duration, $\overline{\text{RD}}$ low	50			ns
t_{en} Enable time, $\overline{\text{RD}}$ low (or $\overline{\text{CS}}$ low for read cycle) to data valid			30	ns
t_{d2} Delay time, data hold from $\overline{\text{RD}}$ high	0			ns
t_{d3} Delay time, BYTE rising edge or falling edge to data valid	2		30	ns
t_{w6} Pulse duration, $\overline{\text{RD}}$ high	20			ns
t_{w7} Pulse duration, $\overline{\text{CS}}$ high	20			ns
t_{h2} Hold time, last $\overline{\text{RD}}$ (or $\overline{\text{CS}}$ for read cycle) rising edge to $\overline{\text{CONVST}}$ falling edge	50			ns
t_{su3} Setup time, BYTE transition to $\overline{\text{RD}}$ falling edge	0			ns
t_{h3} Hold time, BYTE transition to $\overline{\text{RD}}$ falling edge	0			ns
t_{dis} Disable time, $\overline{\text{RD}}$ high ($\overline{\text{CS}}$ high for read cycle) to 3-stated data bus			30	ns
t_{d5} Delay time, end of conversion to MSB data valid			20	ns
t_{su4} Byte transition setup time, from BYTE transition to next BYTE transition	50			ns
t_{d6} Delay time, $\overline{\text{CS}}$ rising edge to BUSY falling edge	50			ns
t_{d7} Delay time, BUSY falling edge to $\overline{\text{CS}}$ rising edge	50			ns
$t_{\text{su(AB)}}$ Setup time, from the falling edge of $\overline{\text{CONVST}}$ (used to start the valid conversion) to the next falling edge of $\overline{\text{CONVST}}$ (when $\overline{\text{CS}} = 0$ and $\overline{\text{CONVST}}$ used to abort) or to the next falling edge of $\overline{\text{CS}}$ (when $\overline{\text{CS}}$ is used to abort)	70		350	ns
t_{su5} Setup time, falling edge of $\overline{\text{CONVST}}$ to read valid data (MSB) from current conversion	MAX(t_{CONV}) + MAX(t_{d5})			ns
t_{h4} Hold time, data (MSB) from previous conversion hold valid from falling edge of $\overline{\text{CONVST}}$	MIN(t_{CONV})			ns

- (1) All input signals are specified with $t_r = t_f = 5\text{ ns}$ (10% to 90% of $+V_{BD}$) and timed from a voltage level of $(V_{\text{IL}} + V_{\text{IH}})/2$.
- (2) See timing diagrams.
- (3) All timings are measured with 20 pF equivalent loads on all data bits and BUSY pins.

PIN ASSIGNMENTS

**PFB PACKAGE
(TOP VIEW)**

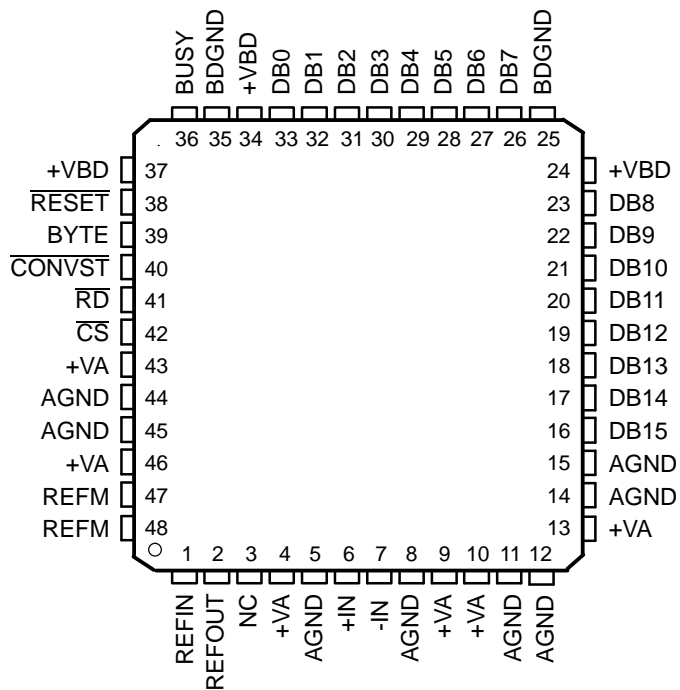

NC - No connection

Terminal Functions

NAME	NO.	I/O	DESCRIPTION		
AGND	5, 8, 11, 12, 14, 15, 44, 45	–	Analog ground		
BDGND	25, 35	–	Digital ground for bus interface digital supply		
BUSY	36	O	Status output. High when a conversion is in progress.		
BYTE	39	I	Byte select input. Used for 8-bit bus reading. 0: No fold back 1: Low byte D[7:0] of the 16 most significant bits is folded back to high byte of the 16 most significant pins DB[15:8].		
$\overline{\text{CONVST}}$	40	I	Convert start. The falling edge of this input ends the acquisition period and starts the hold period.		
$\overline{\text{CS}}$	42	I	Chip select. The falling edge of this input starts the acquisition period.		
Data Bus			8-Bit Bus		16-Bit Bus
			BYTE = 0	BYTE = 1	BYTE = 0
DB15	16	O	D15 (MSB)	D7	D15 (MSB)
DB14	17	O	D14	D6	D14
DB13	18	O	D13	D5	D13
DB12	19	O	D12	D4	D12
DB11	20	O	D11	D3	D11
DB10	21	O	D10	D2	D10
DB9	22	O	D9	D1	D9
DB8	23	O	D8	D0 (LSB)	D8
DB7	26	O	D7	All ones	D7
DB6	27	O	D6	All ones	D6
DB5	28	O	D5	All ones	D5
DB4	29	O	D4	All ones	D4
DB3	30	O	D3	All ones	D3
DB2	31	O	D2	All ones	D2
DB1	32	O	D1	All ones	D1
DB0	33	O	D0 (LSB)	All ones	D0 (LSB)
–IN	7	I	Inverting input channel		
+IN	6	I	Non inverting input channel		
NC	3	–	No connection		
REFIN	1	I	Reference input		
REFM	47, 48	I	Reference ground		
REFOUT	2	O	Reference output. Add 1 μF capacitor between the REFOUT pin and REFM pin when internal reference is used.		
$\overline{\text{RESET}}$	38	I	Current conversion is aborted and output latches are cleared (set to zeros) when this pin is asserted low. $\overline{\text{RESET}}$ works independantly of $\overline{\text{CS}}$.		
$\overline{\text{RD}}$	41	I	Synchronization pulse for the parallel output. When $\overline{\text{CS}}$ is low, this serves as the output enable and puts the previous conversion result on the bus.		
+VA	4, 9, 10, 13, 43, 46	–	Analog power supplies, 5-V dc		
+VBD	24, 34, 37	–	Digital power supply for bus		

TIMING DIAGRAMS

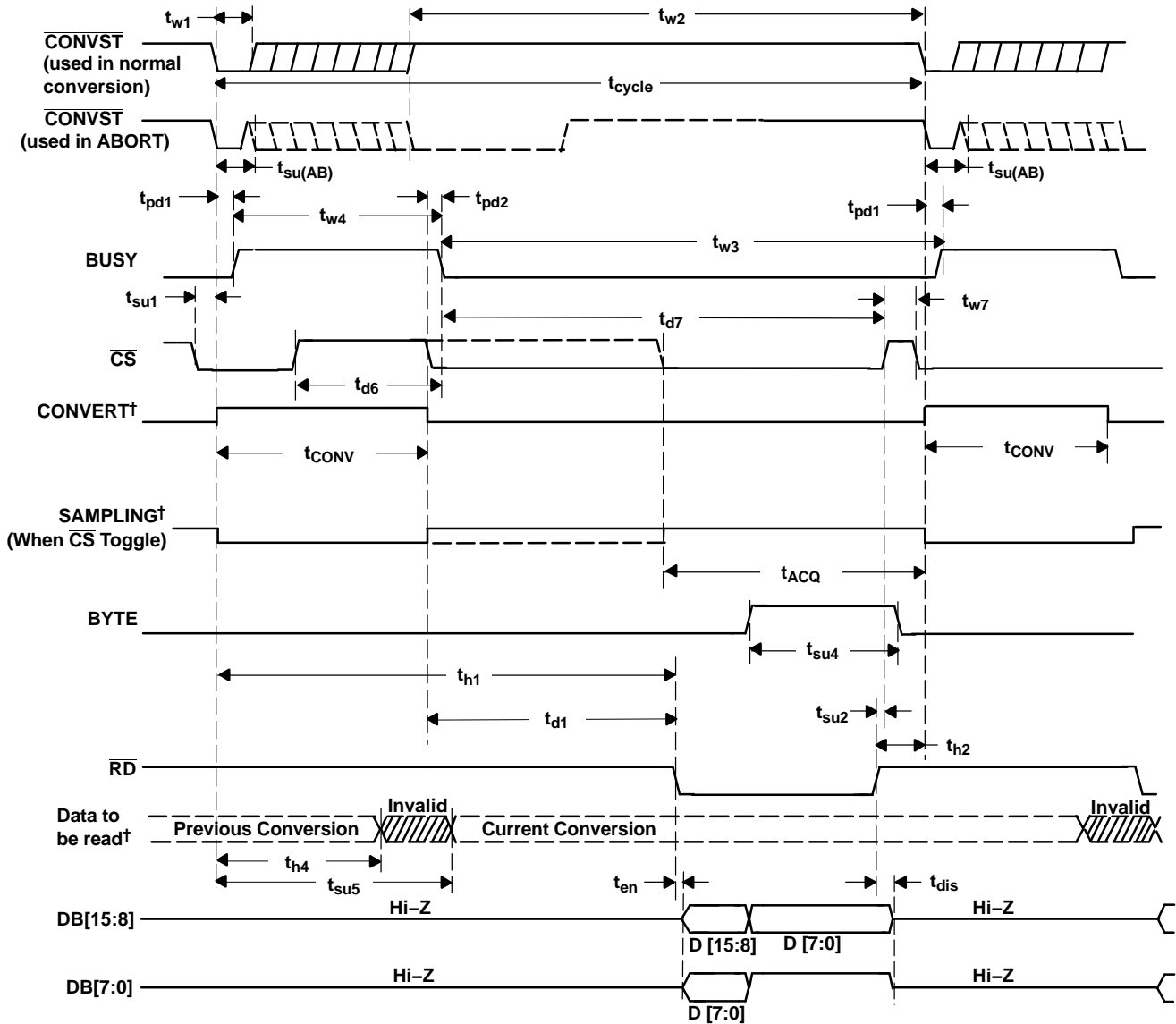

[†]Signal internal to device

Figure 1. Timing for Conversion and Acquisition Cycles With $\overline{\text{CS}}$ and $\overline{\text{RD}}$ Toggling

TIMING DIAGRAMS (continued)

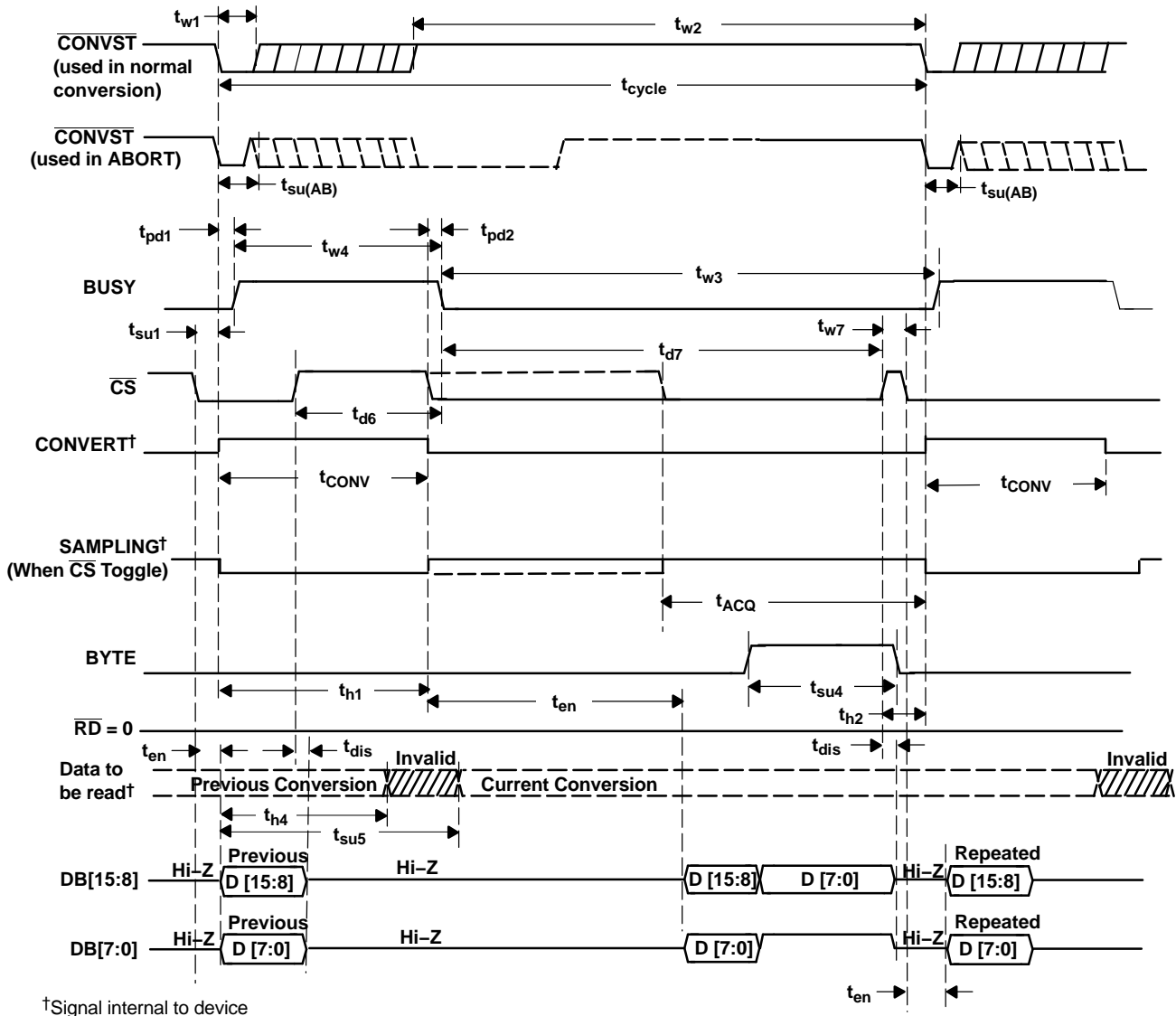

Figure 2. Timing for Conversion and Acquisition Cycles With \overline{CS} Toggling, \overline{RD} Tied to BDGND

TIMING DIAGRAMS (continued)

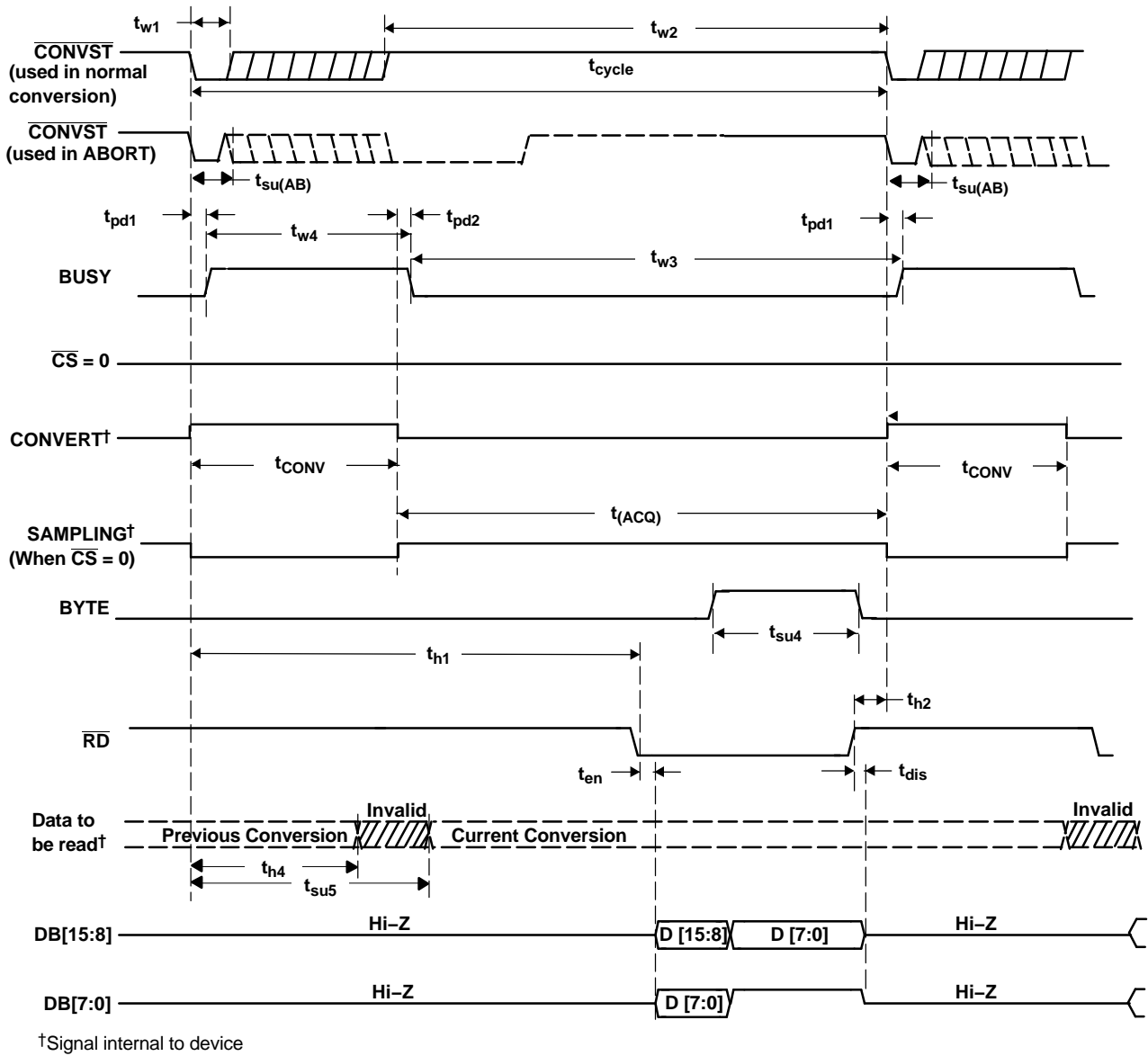
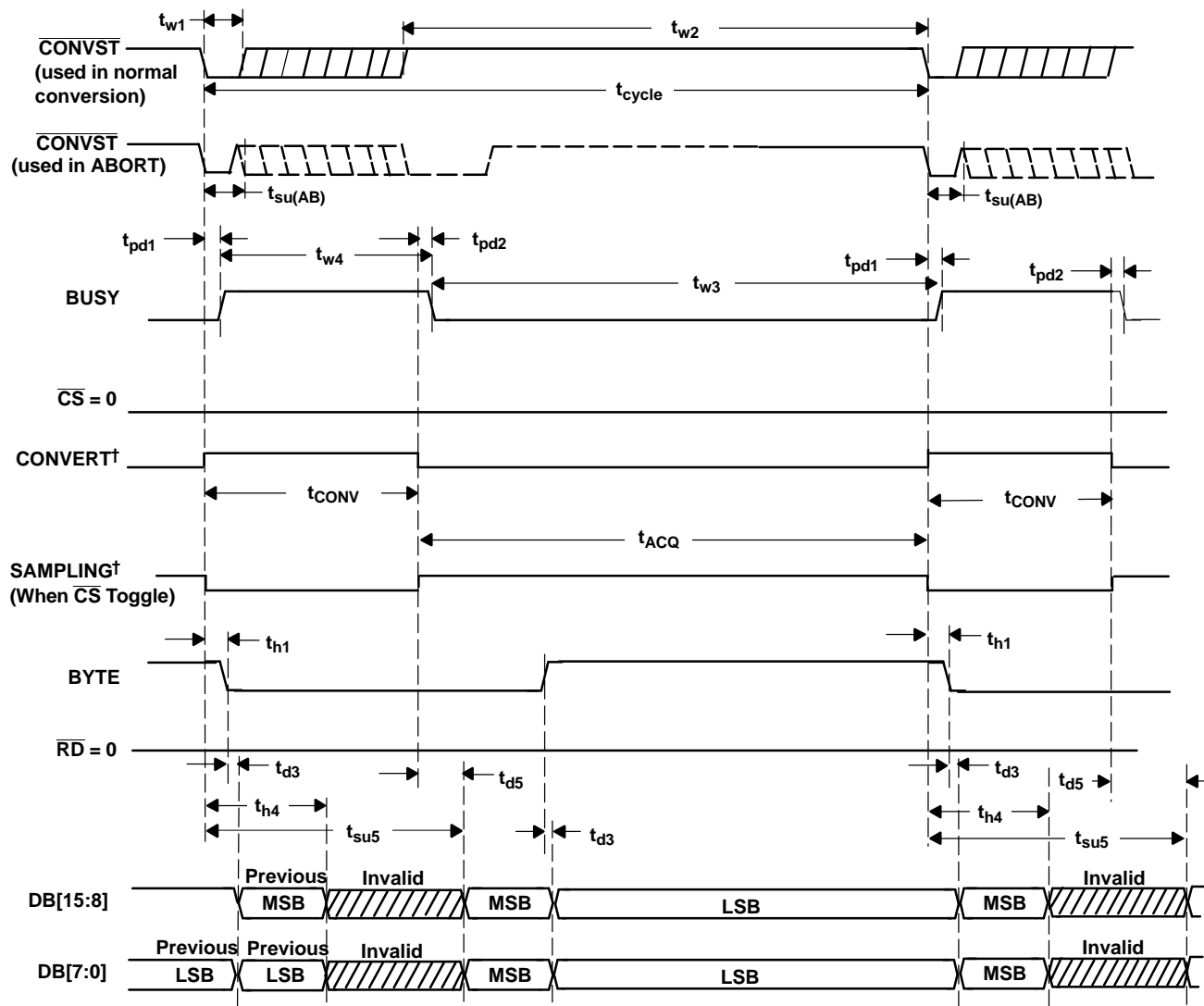

Figure 3. Timing for Conversion and Acquisition Cycles With \overline{CS} Tied to BDGND, \overline{RD} Toggling

TIMING DIAGRAMS (continued)



[†]Signal internal to device

Figure 4. Timing for Conversion and Acquisition Cycles With $\overline{\text{CS}}$ and $\overline{\text{RD}}$ Tied to BDGND—Auto Read

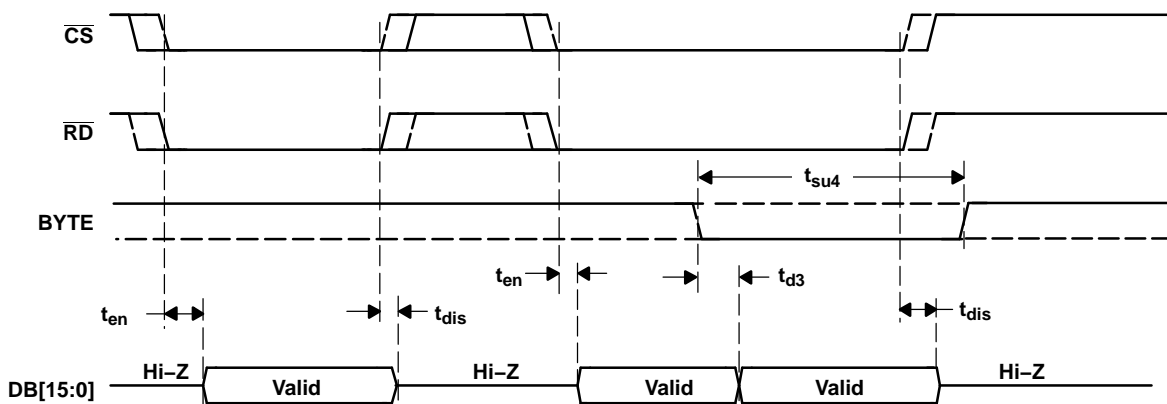

Figure 5. Detailed Timing for Read Cycles

TYPICAL CHARACTERISTICS

At -40°C to 85°C , $+V_A = 5\text{ V}$, $+V_{BD} = 5\text{ V}$, $\text{REFIN} = 4.096\text{ V}$ (internal reference used) and $f_{\text{sample}} = 2\text{ MHz}$ (unless otherwise noted)

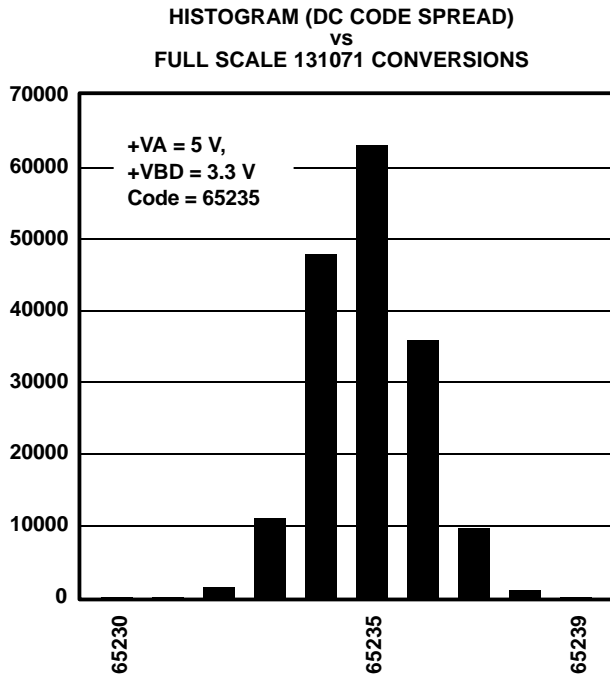

Figure 6.

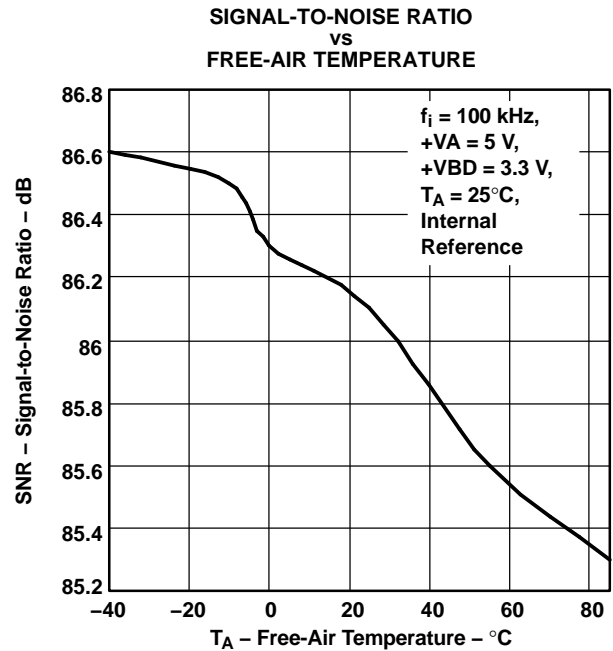

Figure 7.

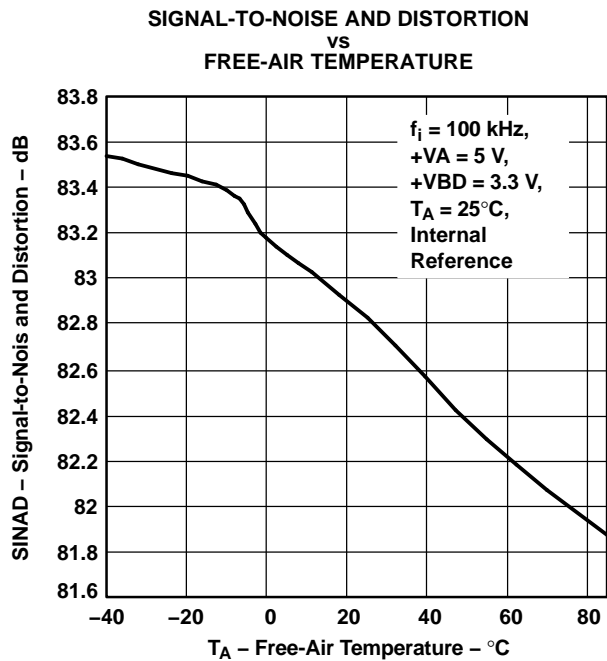

Figure 8.

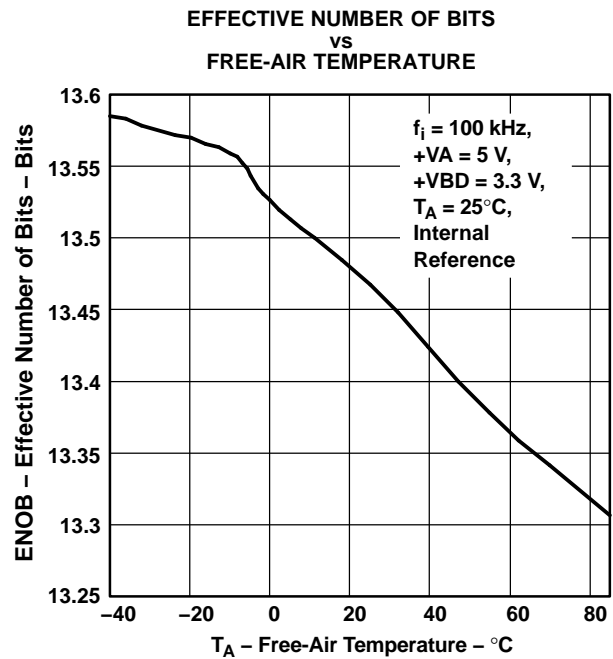

Figure 9.

TYPICAL CHARACTERISTICS (continued)

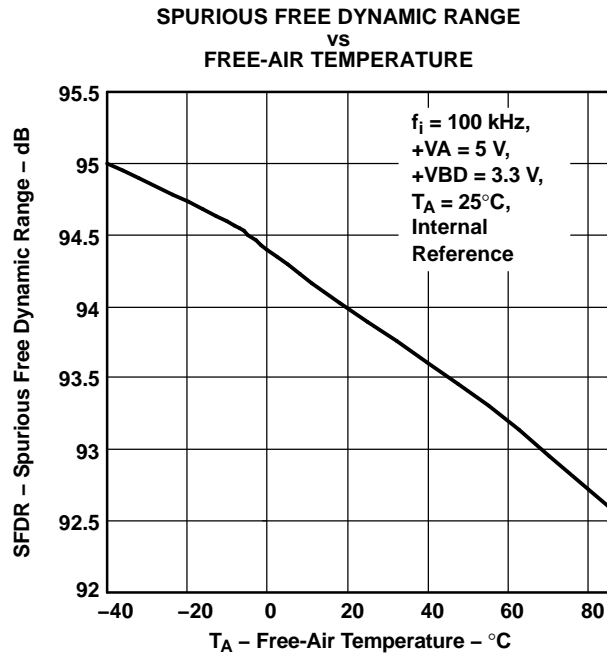

Figure 10.

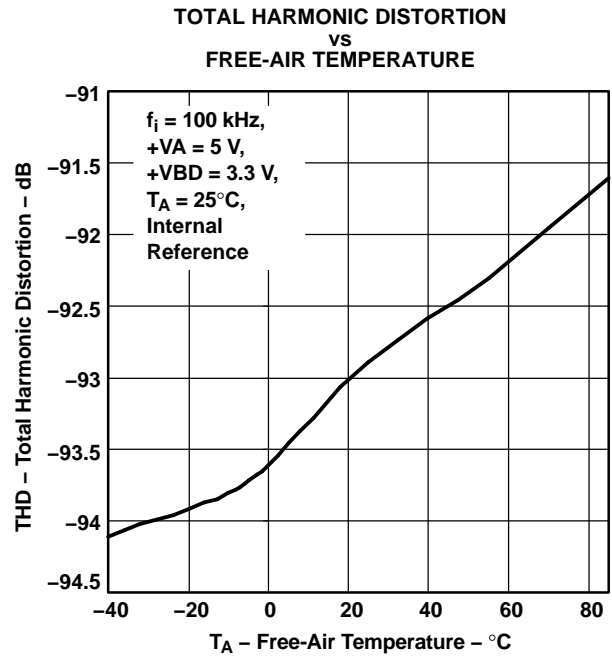

Figure 11.

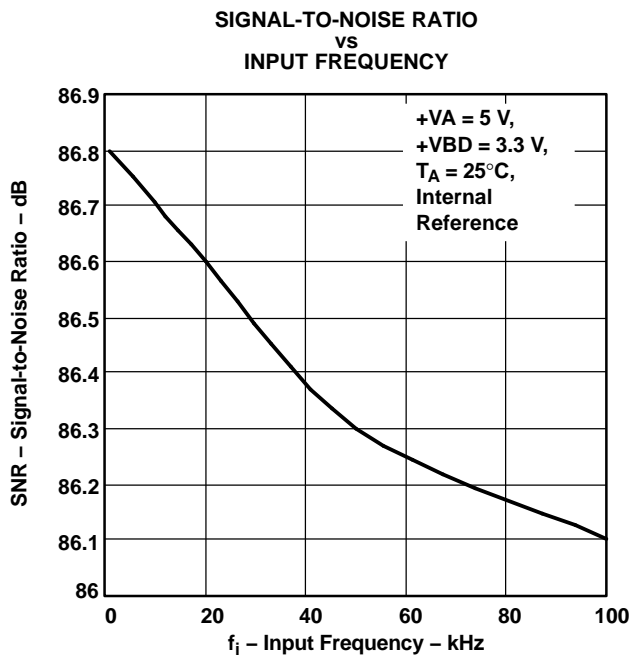

Figure 12.

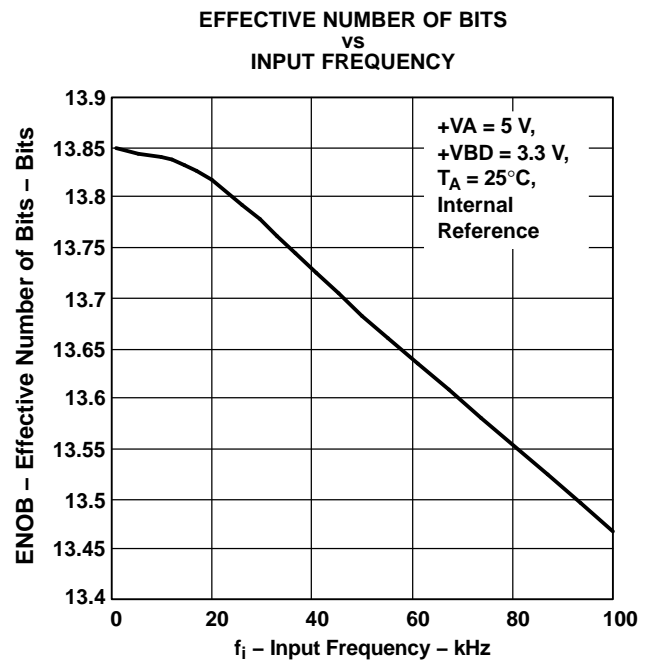

Figure 13.

TYPICAL CHARACTERISTICS (continued)

**SIGNAL-TO-NOISE AND DISTORTION
VS
INPUT FREQUENCY**

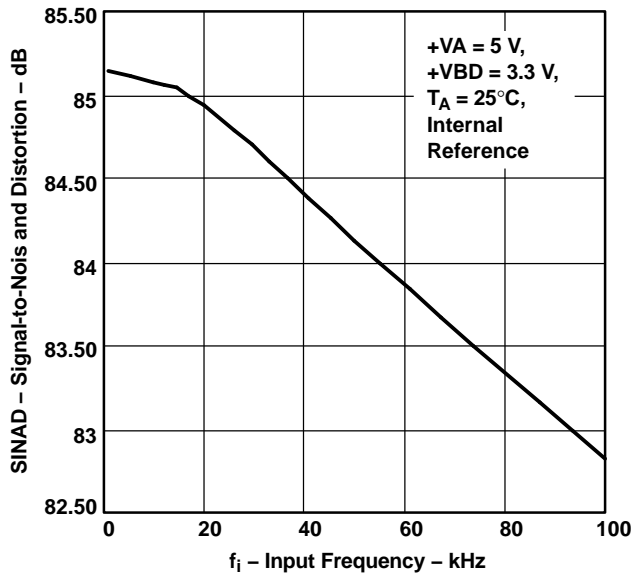

Figure 14.

**SPURIOUS FREE DYNAMIC RANGE
VS
INPUT FREQUENCY**

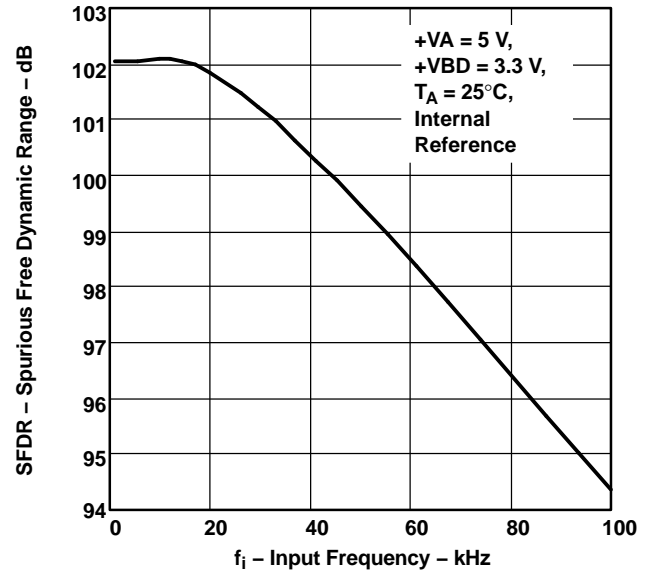

Figure 15.

**TOTAL HARMONIC DISTORTION
VS
INPUT FREQUENCY**

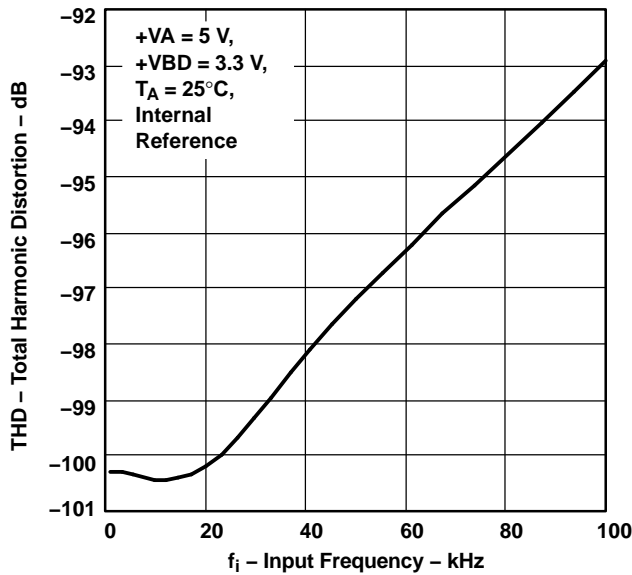

Figure 16.

**SUPPLY CURRENT
VS
SAMPLE RATE**

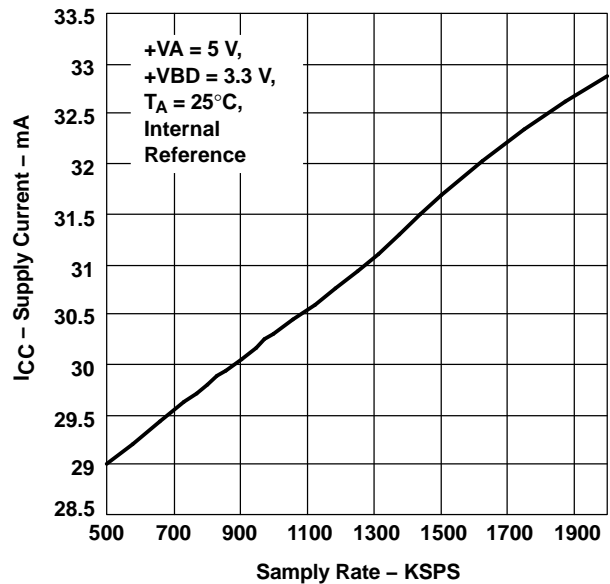

Figure 17.

TYPICAL CHARACTERISTICS (continued)

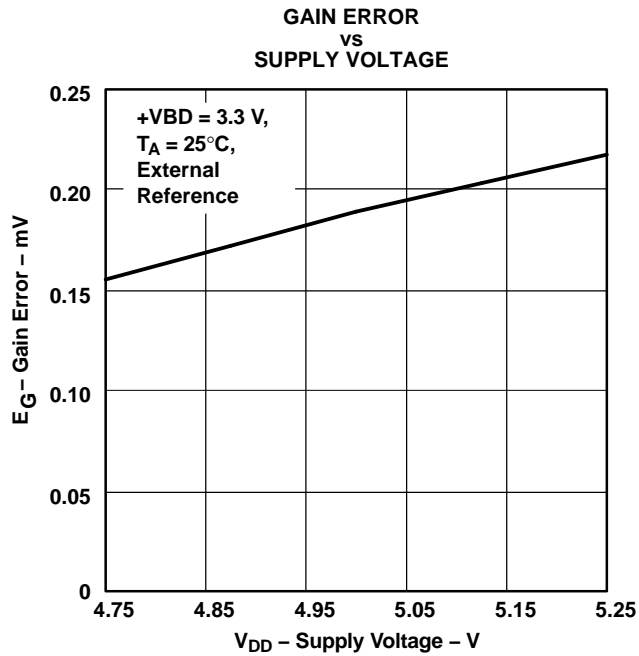

Figure 18.

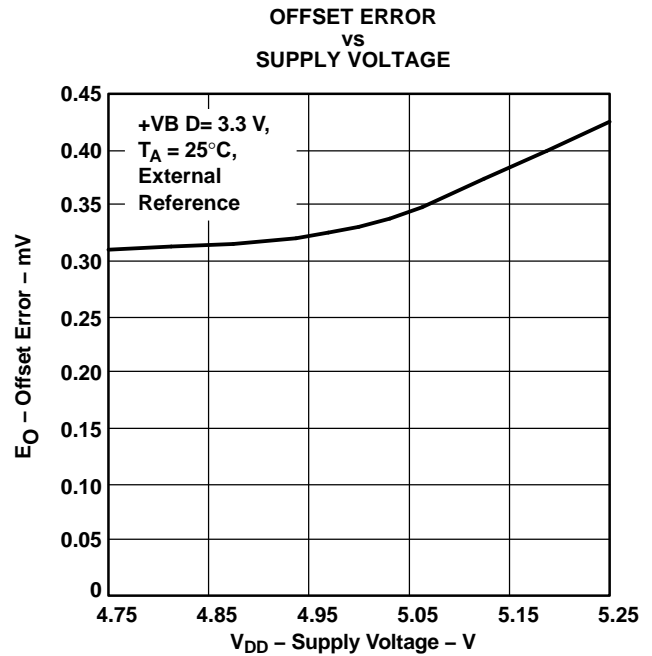

Figure 19.

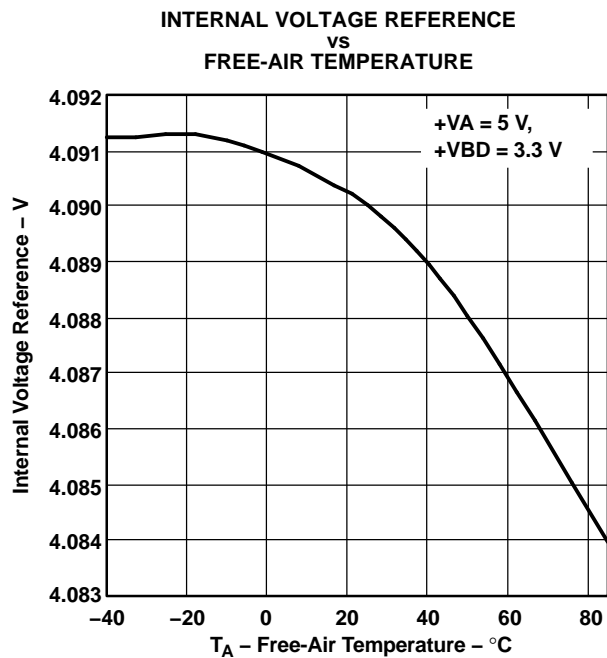

Figure 20.

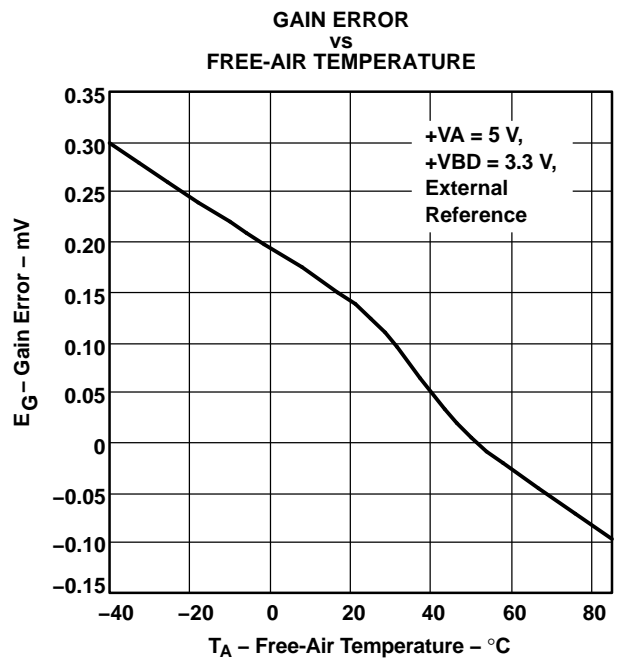

Figure 21.

TYPICAL CHARACTERISTICS (continued)

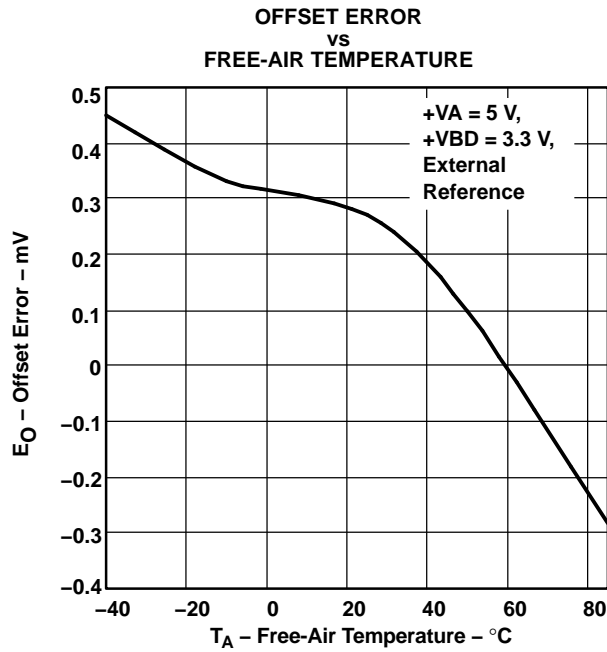

Figure 22.

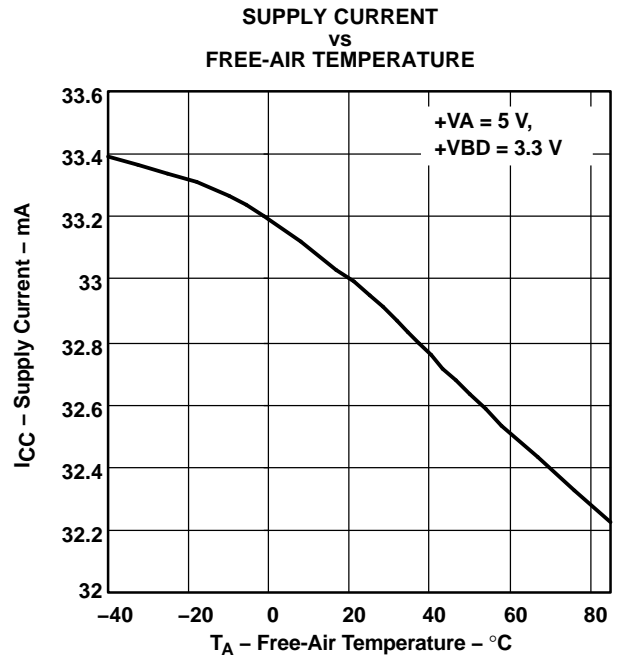

Figure 23.

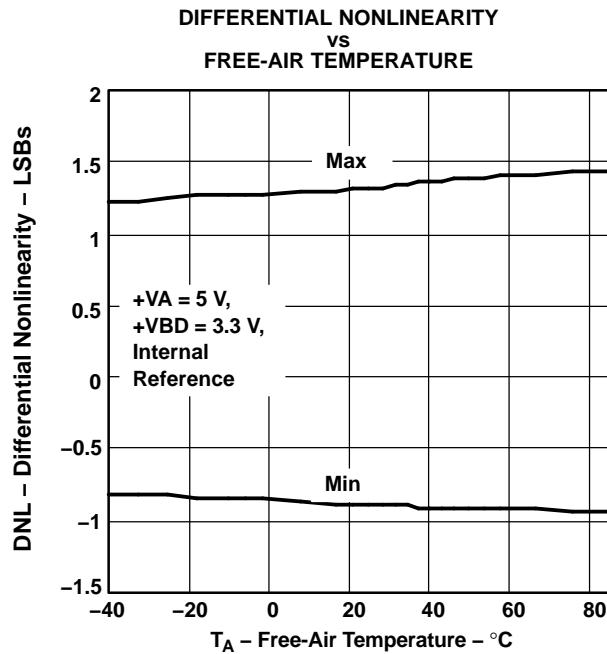

Figure 24.

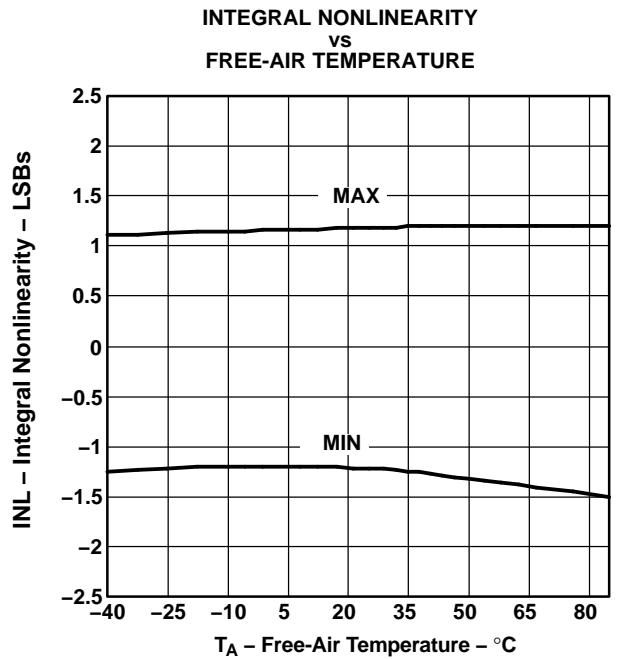

Figure 25.

TYPICAL CHARACTERISTICS (continued)

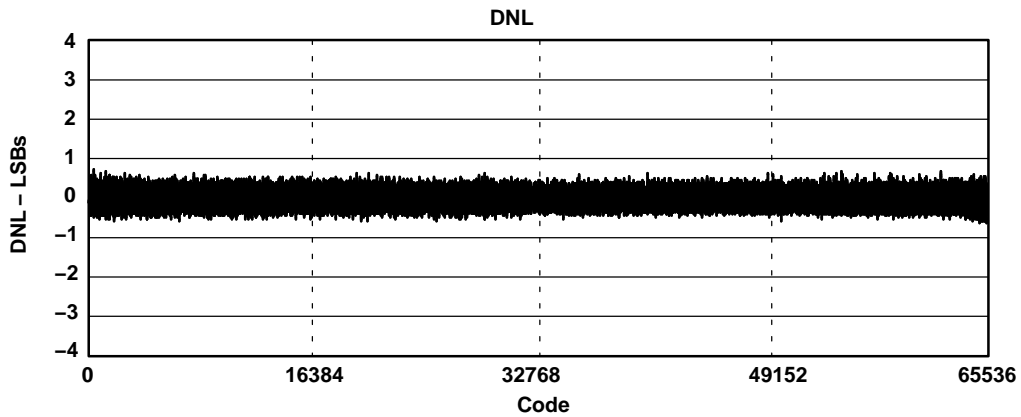

Figure 26.

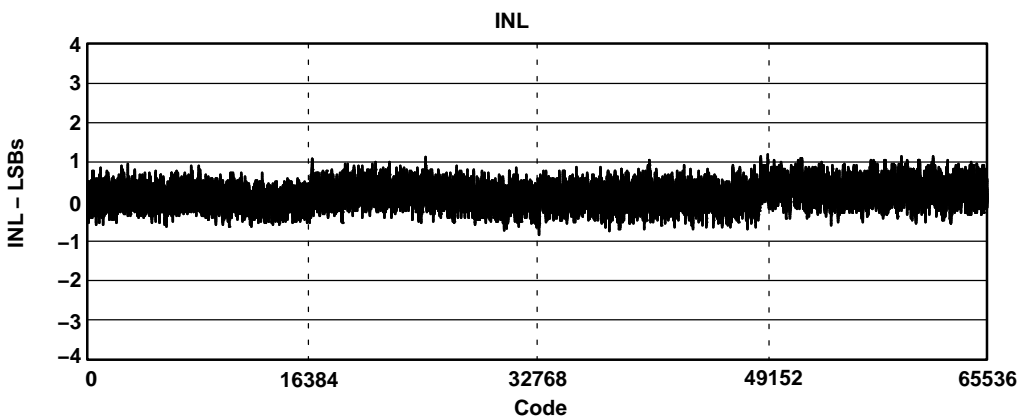

Figure 27.

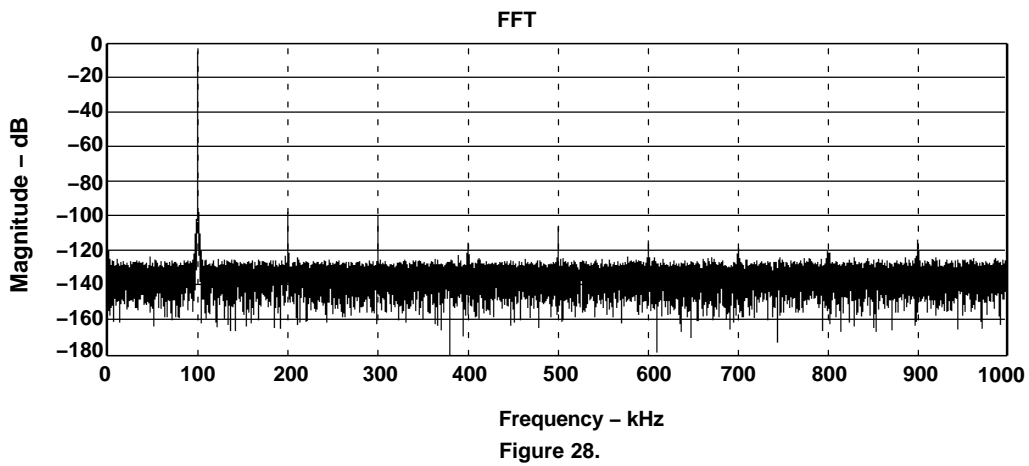

Figure 28.

APPLICATION INFORMATION

MICROCONTROLLER INTERFACING

ADS8411 to 8-Bit Microcontroller Interface

Figure 29 shows a parallel interface between the ADS8411 and a typical microcontroller using the 8-bit data bus. The BUSY signal is used as a falling-edge interrupt to the microcontroller.

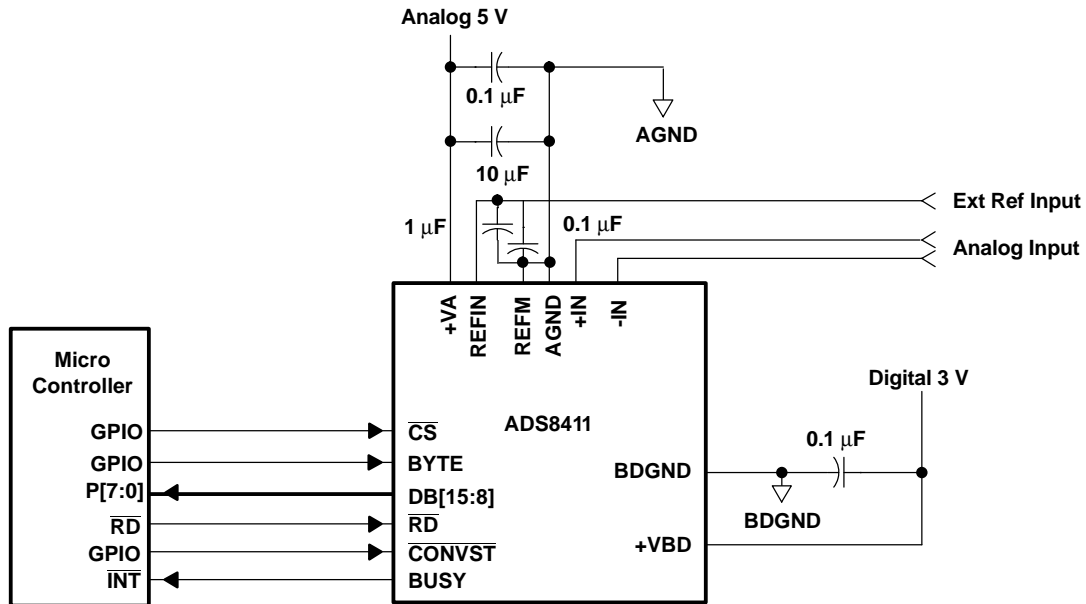

Figure 29. ADS8411 Application Circuitry (using external reference)

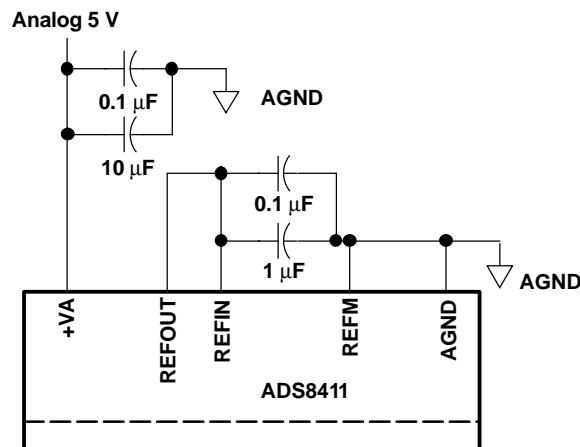

Figure 30. Use Internal Reference

PRINCIPLES OF OPERATION

The ADS8411 is a high-speed successive approximation register (SAR) analog-to-digital converter (ADC). The architecture is based on charge redistribution, which inherently includes a sample/hold function. See Figure 29 for the application circuit for the ADS8411.

The conversion clock is generated internally. The conversion time of 400 ns is capable of sustaining a 2-MHz throughput.

PRINCIPLES OF OPERATION (continued)

The analog input is provided to two input pins: +IN and –IN. When a conversion is initiated, the differential input on these pins is sampled on the internal capacitor array. While a conversion is in progress, both inputs are disconnected from any internal function.

REFERENCE

The ADS8411 can operate with an external reference with a range from 3.9 V to 4.2 V. A 4.096-V internal reference is included. When the internal reference is used, pin 2 (REFOUT) should be connected to pin 1 (REFIN) with 0.1- μ F decoupling capacitor and 1- μ F storage capacitor between pin 2 (REFOUT) and pins 47 and 48 (REFM) (see Figure 30). The internal reference of the converter is double buffered. If an external reference is used, the second buffer provides isolation between the external reference and the CDAC. This buffer is also used to recharge all of the capacitors of the CDAC during conversion. Pin 2 (REFOUT) can be left unconnected (floating) if an external reference is used.

ANALOG INPUT

When the converter enters the hold mode, the voltage difference between the +IN and –IN inputs is captured on the internal capacitor array. The voltage on the –IN input is limited between –0.2 V and 0.2 V, allowing the input to reject small signals which are common to both the +IN and –IN inputs. The +IN input has a range of –0.2 V to $V_{ref} + 0.2$ V. The input span (+IN – (–IN)) is limited to 0 V to V_{ref} .

The input current on the analog inputs depends upon a number of factors: sample rate, input voltage, and source impedance. Essentially, the current into the ADS8411 charges the internal capacitor array during the sample period. After this capacitance has been fully charged, there is no further input current. The source of the analog input voltage must be able to charge the input capacitance (25 pF) to an 16-bit settling level within the acquisition time (100 ns) of the device. When the converter goes into the hold mode, the input impedance is greater than 1 G Ω .

Care must be taken regarding the absolute analog input voltage. To maintain the linearity of the converter, the +IN and –IN inputs and the span (+IN – (–IN)) should be within the limits specified. Outside of these ranges, the converter's linearity may not meet specifications. To minimize noise, low bandwidth input signals with low-pass filters should be used.

Care should be taken to ensure that the output impedance of the sources driving +IN and –IN inputs are matched. If this is not observed, the two inputs could have different settling time. This may result in offset error, gain error and linearity error which varies with temperature and input voltage.

DIGITAL INTERFACE

Timing And Control

See the timing diagrams in the specifications section for detailed information on timing signals and their requirements.

The ADS8411 uses an internal oscillator generated clock which controls the conversion rate and in turn the throughput of the converter. No external clock input is required.

Conversions are initiated by bringing the $\overline{\text{CONVST}}$ pin low for a minimum of 20 ns (after the 20 ns minimum requirement has been met, the $\overline{\text{CONVST}}$ pin can be brought high), while $\overline{\text{CS}}$ is low. The ADS8411 switches from the sample to the hold mode on the falling edge of the $\overline{\text{CONVST}}$ command. A clean and low jitter falling edge of this signal is important to the performance of the converter. The BUSY output is brought high after $\overline{\text{CONVST}}$ goes low. BUSY stays high throughout the conversion process and returns low when the conversion has ended.

Sampling starts with the falling edge of the BUSY signal when $\overline{\text{CS}}$ is tied low or starts with the falling edge of $\overline{\text{CS}}$ when BUSY is low.

Both $\overline{\text{RD}}$ and $\overline{\text{CS}}$ can be high during and before a conversion with one exception ($\overline{\text{CS}}$ must be low when $\overline{\text{CONVST}}$ goes low to initiate a conversion). Both the $\overline{\text{RD}}$ and $\overline{\text{CS}}$ pins are brought low in order to enable the parallel output bus with the conversion.

PRINCIPLES OF OPERATION (continued)

Reading Data

The ADS8411 outputs full parallel data in straight binary format as shown in Table 1. The parallel output is active when \overline{CS} and \overline{RD} are both low. There is a minimal quiet zone requirement around the falling edge of \overline{CONVST} . This is 50 ns prior to the falling edge of \overline{CONVST} and 40 ns after the falling edge. No data read should be attempted within this zone. Any other combination of \overline{CS} and \overline{RD} sets the parallel output to 3-state. BYTE is used for multiword read operations. BYTE is used whenever lower bits of the converter result are output on the higher byte of the bus. Refer to Table 1 for ideal output codes.

Table 1. Ideal Input Voltages and Output Codes

DESCRIPTION	ANALOG VALUE	DIGITAL OUTPUT	
		STRAIGHT BINARY	
Full scale range	V_{ref}		
Least significant bit (LSB)	$V_{ref}/65536$	BINARY CODE	HEX CODE
Full scale	$V_{ref} - 1 \text{ LSB}$	1111 1111 1111 1111	FFFF
Midscale	$V_{ref}/2$	1000 0000 0000 0000	8000
Midscale – 1 LSB	$V_{ref}/2 - 1 \text{ LSB}$	0111 1111 1111 1111	7FFF
Zero	0 V	0000 0000 0000 0000	0000

The output data is a full 16-bit word (D15–D0) on DB15–DB0 pins (MSB-LSB) if BYTE is low.

The result may also be read on an 8-bit bus for convenience. This is done by using only pins DB15-DB8. In this case two reads are necessary: the first as before, leaving BYTE low and reading the 8 most significant bits on pins DB15-DB8, then bringing BYTE high, the low bits (D7–D0) appear on pins DB15–D8.

These multiword read operations can be done with multiple active \overline{RD} (toggling) or with \overline{RD} tied low for simplicity.

Table 2. Conversion Data Readout

BYTE	DATA READ OUT	
	DB15–DB8 Pins	DB7-DB0 Pins
High	D7–D0	All one's
Low	D15–D8	D7-D0

RESET

\overline{RESET} is an asynchronous active low input signal (that works independently of \overline{CS}). Minimum \overline{RESET} low time is 25 ns. Current conversion will be aborted no later than 50 ns after the converter is in the reset mode. In addition, all output latches are cleared (set to zero's) after \overline{RESET} . The converter goes back to normal operation mode no later than 20 ns after \overline{RESET} input is brought high.

The converter starts the first sampling period 20 ns after the rising edge of \overline{RESET} . Any sampling period except for the one immediately after a \overline{RESET} is started with the falling edge of the previous BUSY signal or the falling edge of CS, whichever is later.

Another way to reset the device is through the use of the combination of \overline{CS} and \overline{CONVST} . This is useful when the dedicated \overline{RESET} pin is tied to the system reset but there is a need to abort only the conversion in a specific converter. Since the BUSY signal is held high during the conversion, either one of these conditions triggers an internal self-clear reset to the converter just the same as a reset via the dedicated \overline{RESET} pin. The reset does not have to be cleared as for the dedicated \overline{RESET} pin. A reset can be started with either of the two following steps.

- Issue a \overline{CONVST} when \overline{CS} is low and a conversion is in progress. The falling edge of \overline{CONVST} must satisfy the timing as specified by the timing parameter $t_{su(AB)}$ mentioned in the timing characteristics table to ensure a reset. The falling edge of \overline{CONVST} starts a reset. Timing is the same as a reset using the dedicated \overline{RESET} pin except the instance of the falling edge is replaced by the falling edge of \overline{CONVST} .
- Issue a \overline{CS} while a conversion is in progress. The falling edge of \overline{CS} must satisfy the timing as specified by the timing parameter $t_{su(AB)}$ mentioned in the timing characteristics table to ensure a reset. The falling edge of \overline{CS} causes a reset. Timing is the same as a reset using the dedicated \overline{RESET} pin except the instance of the falling edge is replaced by the falling edge of \overline{CS} .

POWER-ON INITIALIZATION

RESET is not required after power on. An internal power-on-reset circuit generates the reset. To ensure that all of the registers are cleared, the three conversion cycles must be given to the converter after power on.

LAYOUT

For optimum performance, care should be taken with the physical layout of the ADS8411 circuitry.

As the ADS8411 offers single-supply operation, it is often used in close proximity with digital logic, microcontrollers, microprocessors, and digital signal processors. The more digital logic present in the design and the higher the switching speed, the more difficult it is to achieve good performance from the converter.

The basic SAR architecture is sensitive to glitches or sudden changes on the power supply, reference, ground connections and digital inputs that occur just prior to latching the output of the analog comparator. Thus, driving any single conversion for an n-bit SAR converter, there are at least n *windows* in which large external transient voltages can affect the conversion result. Such glitches might originate from switching power supplies, nearby digital logic, or high power devices.

The degree of error in the digital output depends on the reference voltage, layout, and the exact timing of the external event.

On average, the ADS8411 draws very little current from an external reference, as the reference voltage is internally buffered. If the reference voltage is external and originates from an op amp, make sure that it can drive the bypass capacitor or capacitors without oscillation. A 0.1- μ F bypass capacitor and a 1- μ F storage capacitor are recommended from pin 1 (REFIN) directly to pin 48 (REFM). REFM and AGND should be shorted on the same ground plane under the device.

The AGND and BDGND pins should be connected to a clean ground point. In all cases, this should be the analog ground. Avoid connections which are close to the grounding point of a microcontroller or digital signal processor. If required, run a ground trace directly from the converter to the power supply entry point. The ideal layout consists of an analog ground plane dedicated to the converter and associated analog circuitry.

As with the AGND connections, +VA should be connected to a 5-V power supply plane or trace that is separate from the connection for digital logic until they are connected at the power entry point. Power to the ADS8411 should be clean and well bypassed. A 0.1- μ F ceramic bypass capacitor should be placed as close to the device as possible. See Table 3 for the placement of the capacitor. In addition, a 1- μ F to 10- μ F capacitor is recommended. In some situations, additional bypassing may be required, such as a 100- μ F electrolytic capacitor or even a Pi filter made up of inductors and capacitors—all designed to essentially low-pass filter the 5-V supply, removing the high frequency noise.

Table 3. Power Supply Decoupling Capacitor Placement

POWER SUPPLY PLANE	CONVERTER ANALOG SIDE	CONVERTER DIGITAL SIDE
SUPPLY PINS		
Pin pairs that require shortest path to decoupling capacitors	(4,5), (8,9), (10,11), (13,15), (43,44), (45,46)	(24,25), (34, 35)
Pins that require no decoupling	12, 14	37

PACKAGING INFORMATION

Orderable part number	Status (1)	Material type (2)	Package Pins	Package qty Carrier	RoHS (3)	Lead finish/ Ball material (4)	MSL rating/ Peak reflow (5)	Op temp (°C)	Part marking (6)
ADS8411IBPFBR	Active	Production	TQFP (PFB) 48	1000 LARGE T&R	Yes	NIPDAU	Level-2-260C-1 YEAR	-40 to 85	ADS8411I B
ADS8411IBPFBR.B	Active	Production	TQFP (PFB) 48	1000 LARGE T&R	Yes	NIPDAU	Level-2-260C-1 YEAR	-40 to 85	ADS8411I B
ADS8411IBPFBT	Active	Production	TQFP (PFB) 48	250 SMALL T&R	Yes	Call TI	Level-2-260C-1 YEAR	-40 to 85	ADS8411I B
ADS8411IBPFBT.B	Active	Production	TQFP (PFB) 48	250 SMALL T&R	Yes	Call TI	Level-2-260C-1 YEAR	-40 to 85	ADS8411I B
ADS8411IPFBT	Active	Production	TQFP (PFB) 48	250 SMALL T&R	Yes	Call TI	Level-2-260C-1 YEAR	-40 to 85	ADS8411I
ADS8411IPFBT.B	Active	Production	TQFP (PFB) 48	250 SMALL T&R	Yes	Call TI	Level-2-260C-1 YEAR	-40 to 85	ADS8411I

(1) **Status:** For more details on status, see our [product life cycle](#).

(2) **Material type:** When designated, preproduction parts are prototypes/experimental devices, and are not yet approved or released for full production. Testing and final process, including without limitation quality assurance, reliability performance testing, and/or process qualification, may not yet be complete, and this item is subject to further changes or possible discontinuation. If available for ordering, purchases will be subject to an additional waiver at checkout, and are intended for early internal evaluation purposes only. These items are sold without warranties of any kind.

(3) **RoHS values:** Yes, No, RoHS Exempt. See the [TI RoHS Statement](#) for additional information and value definition.

(4) **Lead finish/Ball material:** Parts may have multiple material finish options. Finish options are separated by a vertical ruled line. Lead finish/Ball material values may wrap to two lines if the finish value exceeds the maximum column width.

(5) **MSL rating/Peak reflow:** The moisture sensitivity level ratings and peak solder (reflow) temperatures. In the event that a part has multiple moisture sensitivity ratings, only the lowest level per JEDEC standards is shown. Refer to the shipping label for the actual reflow temperature that will be used to mount the part to the printed circuit board.

(6) **Part marking:** There may be an additional marking, which relates to the logo, the lot trace code information, or the environmental category of the part.

Multiple part markings will be inside parentheses. Only one part marking contained in parentheses and separated by a "-" will appear on a part. If a line is indented then it is a continuation of the previous line and the two combined represent the entire part marking for that device.

Important Information and Disclaimer: The information provided on this page represents TI's knowledge and belief as of the date that it is provided. TI bases its knowledge and belief on information provided by third parties, and makes no representation or warranty as to the accuracy of such information. Efforts are underway to better integrate information from third parties. TI has taken and continues to take reasonable steps to provide representative

and accurate information but may not have conducted destructive testing or chemical analysis on incoming materials and chemicals. TI and TI suppliers consider certain information to be proprietary, and thus CAS numbers and other limited information may not be available for release.

In no event shall TI's liability arising out of such information exceed the total purchase price of the TI part(s) at issue in this document sold by TI to Customer on an annual basis.

TAPE AND REEL INFORMATION

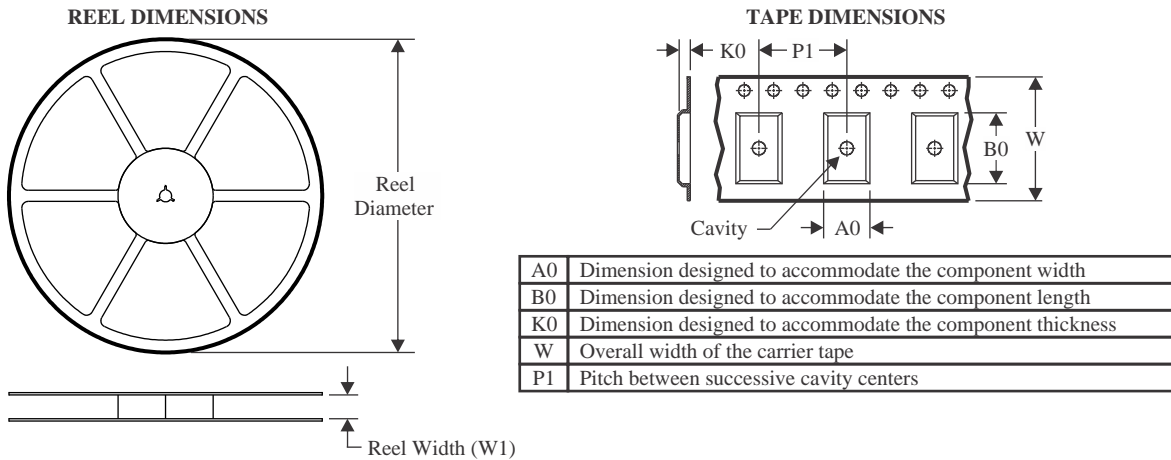

QUADRANT ASSIGNMENTS FOR PIN 1 ORIENTATION IN TAPE

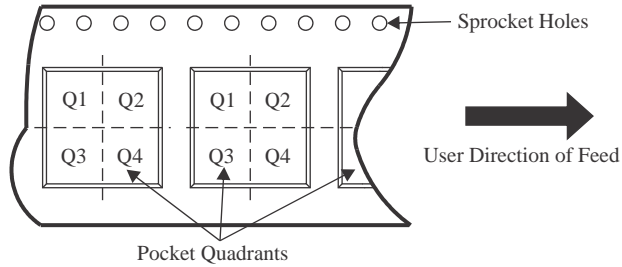

*All dimensions are nominal

Device	Package Type	Package Drawing	Pins	SPQ	Reel Diameter (mm)	Reel Width W1 (mm)	A0 (mm)	B0 (mm)	K0 (mm)	P1 (mm)	W (mm)	Pin1 Quadrant
ADS8411IBPFBR	TQFP	PFB	48	1000	330.0	16.4	9.6	9.6	1.5	12.0	16.0	Q2

TAPE AND REEL BOX DIMENSIONS



*All dimensions are nominal

Device	Package Type	Package Drawing	Pins	SPQ	Length (mm)	Width (mm)	Height (mm)
ADS8411IBPFBR	TQFP	PFB	48	1000	350.0	350.0	43.0

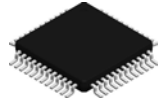

PFB0048A

PACKAGE OUTLINE

TQFP - 1.2 mm max height

PLASTIC QUAD FLATPACK

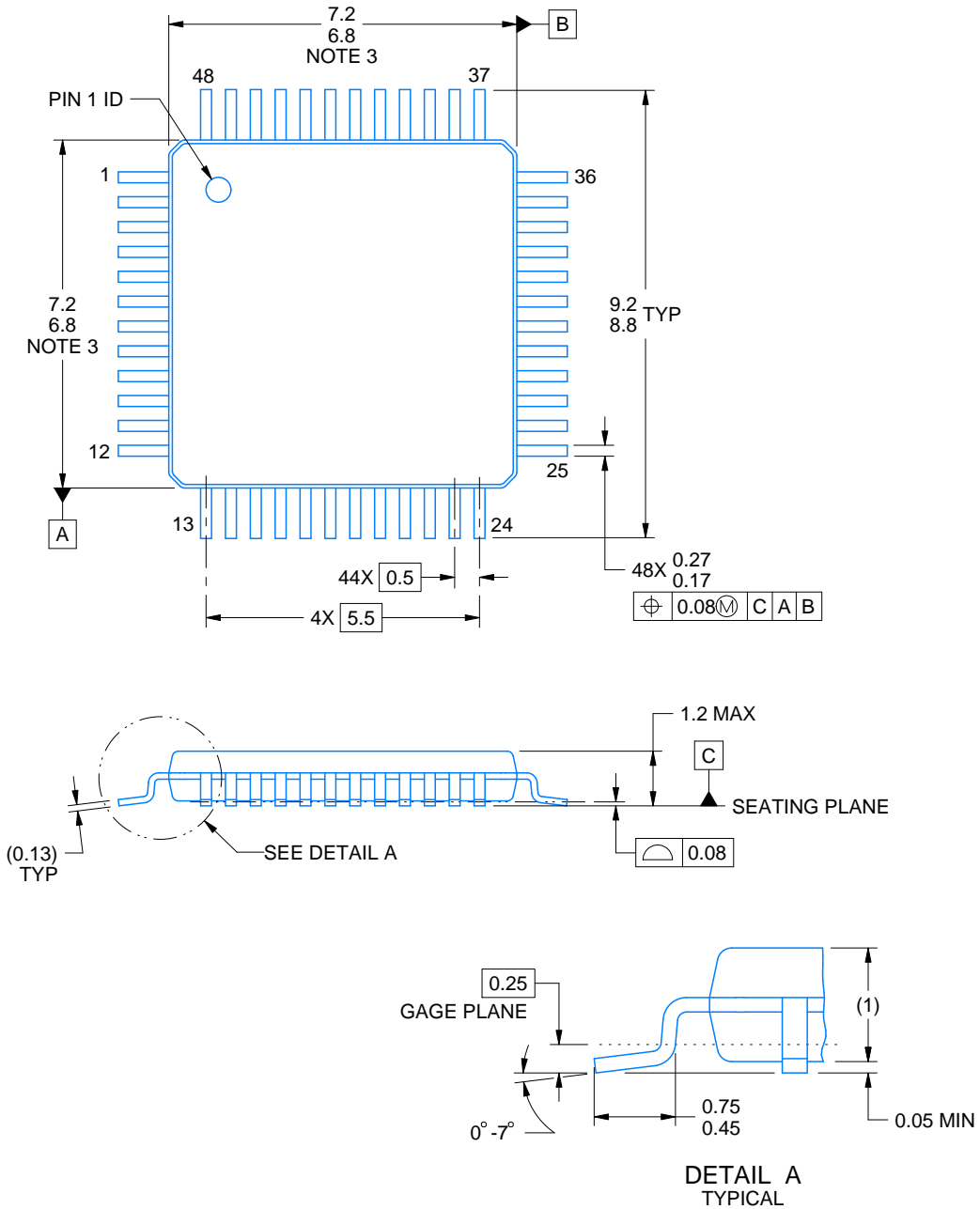

4215157/A 03/2024

NOTES:

1. All linear dimensions are in millimeters. Any dimensions in parenthesis are for reference only. Dimensioning and tolerancing per ASME Y14.5M.
2. This drawing is subject to change without notice.
3. Reference JEDEC registration MS-026.

EXAMPLE BOARD LAYOUT

PFB0048A

TQFP - 1.2 mm max height

PLASTIC QUAD FLATPACK

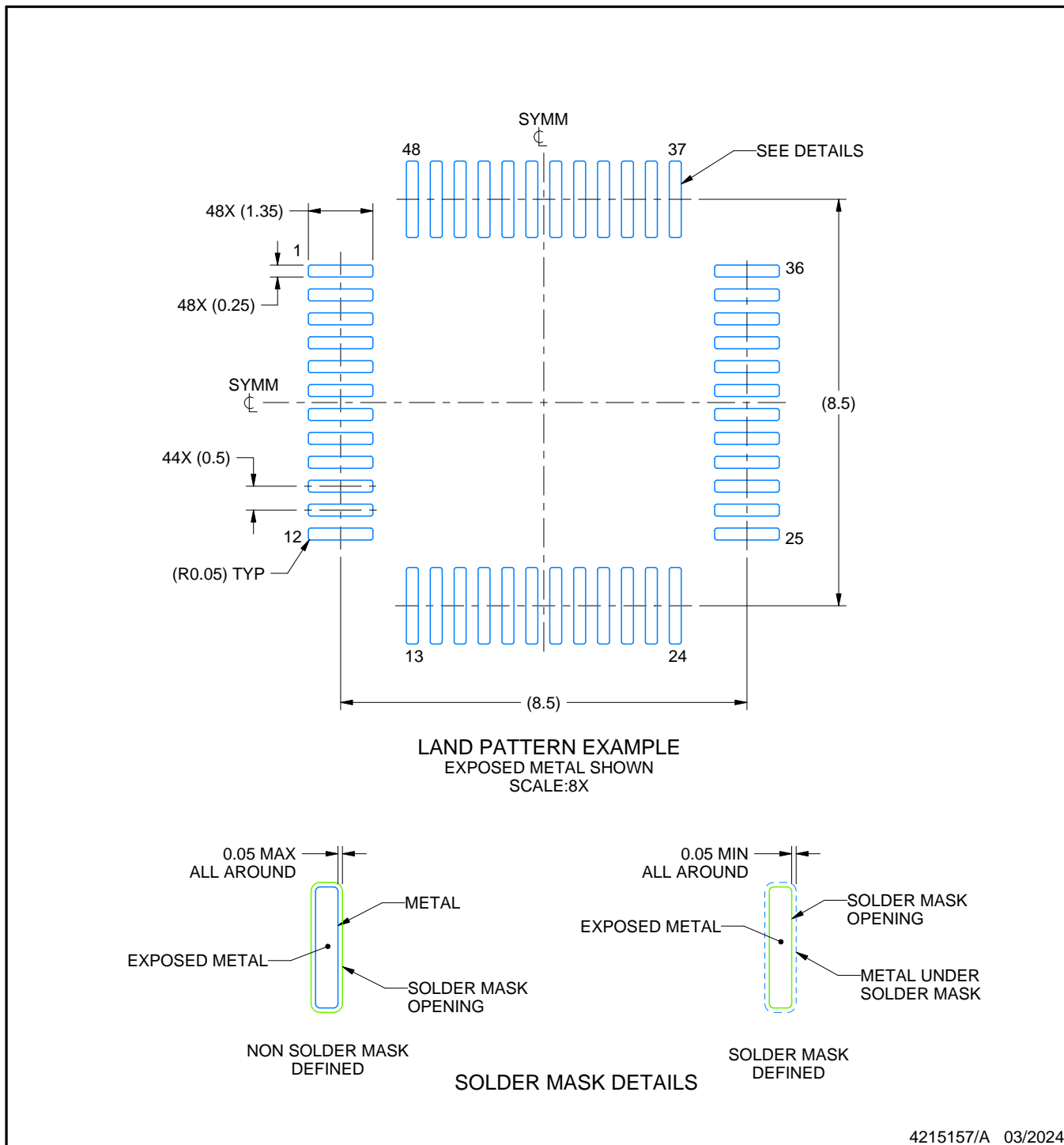

4215157/A 03/2024

NOTES: (continued)

- 4. Publication IPC-7351 may have alternate designs.
- 5. Solder mask tolerances between and around signal pads can vary based on board fabrication site.

EXAMPLE STENCIL DESIGN

PFB0048A

TQFP - 1.2 mm max height

PLASTIC QUAD FLATPACK

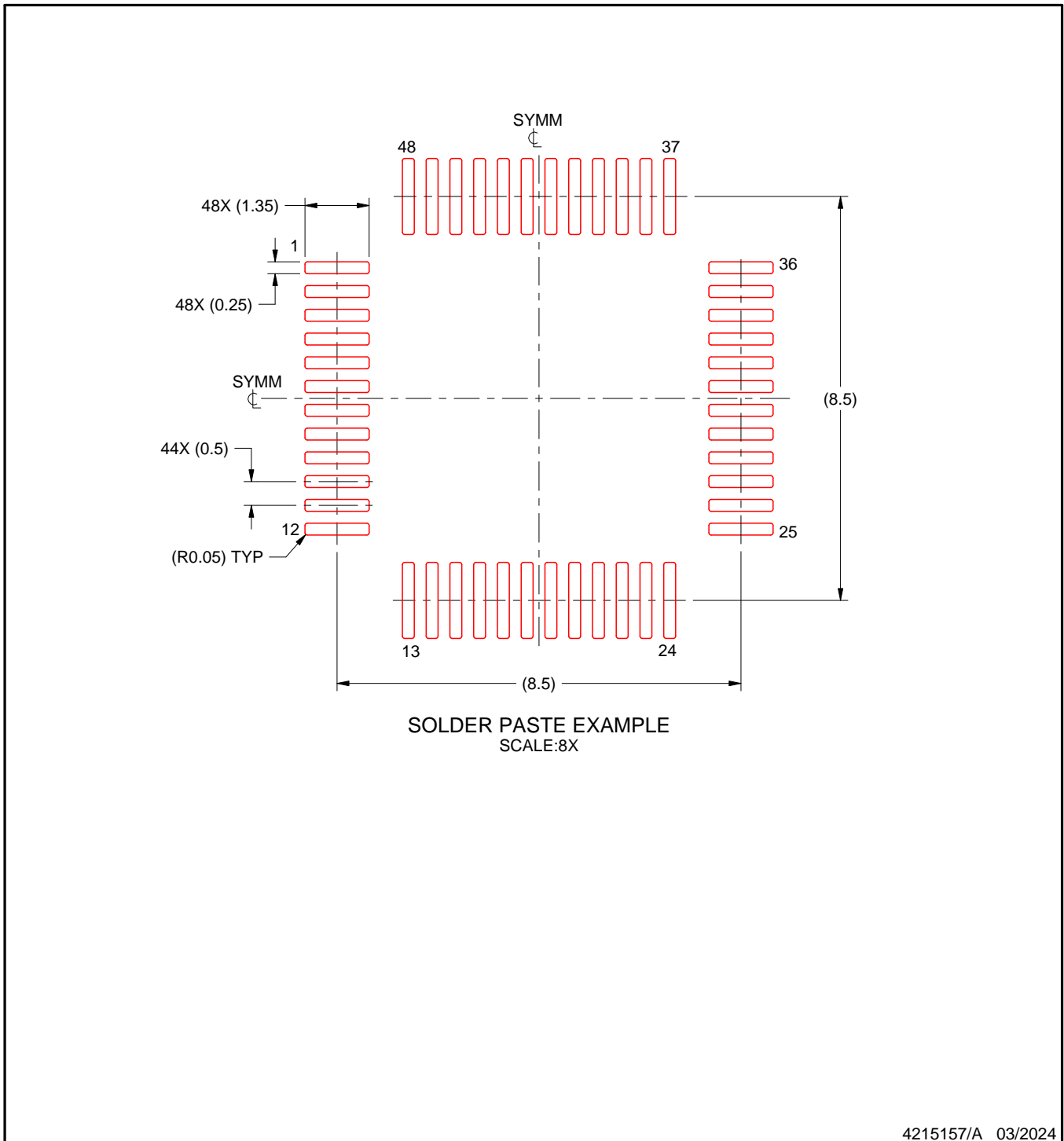

NOTES: (continued)

6. Laser cutting apertures with trapezoidal walls and rounded corners may offer better paste release. IPC-7525 may have alternate design recommendations.
7. Board assembly site may have different recommendations for stencil design.

IMPORTANT NOTICE AND DISCLAIMER

TI PROVIDES TECHNICAL AND RELIABILITY DATA (INCLUDING DATASHEETS), DESIGN RESOURCES (INCLUDING REFERENCE DESIGNS), APPLICATION OR OTHER DESIGN ADVICE, WEB TOOLS, SAFETY INFORMATION, AND OTHER RESOURCES "AS IS" AND WITH ALL FAULTS, AND DISCLAIMS ALL WARRANTIES, EXPRESS AND IMPLIED, INCLUDING WITHOUT LIMITATION ANY IMPLIED WARRANTIES OF MERCHANTABILITY, FITNESS FOR A PARTICULAR PURPOSE OR NON-INFRINGEMENT OF THIRD PARTY INTELLECTUAL PROPERTY RIGHTS.

These resources are intended for skilled developers designing with TI products. You are solely responsible for (1) selecting the appropriate TI products for your application, (2) designing, validating and testing your application, and (3) ensuring your application meets applicable standards, and any other safety, security, regulatory or other requirements.

These resources are subject to change without notice. TI grants you permission to use these resources only for development of an application that uses the TI products described in the resource. Other reproduction and display of these resources is prohibited. No license is granted to any other TI intellectual property right or to any third party intellectual property right. TI disclaims responsibility for, and you fully indemnify TI and its representatives against any claims, damages, costs, losses, and liabilities arising out of your use of these resources.

TI's products are provided subject to [TI's Terms of Sale](#), [TI's General Quality Guidelines](#), or other applicable terms available either on ti.com or provided in conjunction with such TI products. TI's provision of these resources does not expand or otherwise alter TI's applicable warranties or warranty disclaimers for TI products. Unless TI explicitly designates a product as custom or customer-specified, TI products are standard, catalog, general purpose devices.

TI objects to and rejects any additional or different terms you may propose.

Copyright © 2025, Texas Instruments Incorporated

Last updated 10/2025

OUR CERTIFICATE

DiGi provide top-quality products and perfect service for customer worldwide through standardization, technological innovation and continuous improvement. DiGi through third-party certification, we stricly control the quality of products and services. Welcome your RFQ to

Email: Info@DiGi-Electronics.com



Tel: +00 852-30501935

RFQ Email: Info@DiGi-Electronics.com

DiGi is a global authorized distributor of electronic components.