

ADS8422IBPFBR Datasheet

www.digi-electronics.com

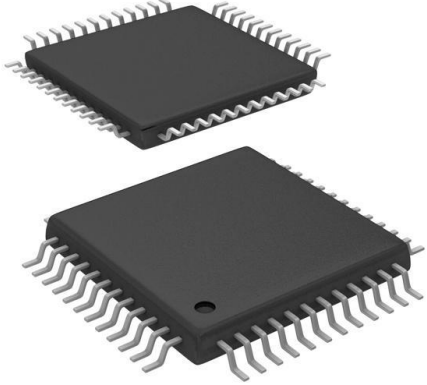

ADS8422IBPFBR

<https://www.DiGi-Electronics.com>

| | |
|------------------------------|--|
| DiGi Electronics Part Number | ADS8422IBPFBR-DG |
| Manufacturer | Texas Instruments |
| Manufacturer Product Number | ADS8422IBPFBR |
| Description | IC ADC 16BIT SAR 48TQFP |
| Detailed Description | 16 Bit Analog to Digital Converter 1 Input 1 SAR 48-TQFP (7x7) |



Tel: +00 852-30501935

RFQ Email: Info@DiGi-Electronics.com

DiGi is a global authorized distributor of electronic components.

Purchase and inquiry

Manufacturer Product Number:

ADS8422IBPFBR

Series:

microPOWER™

Number of Bits:

16

Number of Inputs:

1

Data Interface:

Parallel

Ratio - S/H:ADC:

1:1

Architecture:

SAR

Voltage - Supply, Analog:

5V

Features:

-

Package / Case:

48-TQFP

Mounting Type:

Surface Mount

Manufacturer:

Texas Instruments

Product Status:

Active

Sampling Rate (Per Second):

4M

Input Type:

Differential

Configuration:

S/H-ADC

Number of A/D Converters:

1

Reference Type:

External, Internal

Voltage - Supply, Digital:

2.7V ~ 5.25V

Operating Temperature:

-40°C ~ 85°C

Supplier Device Package:

48-TQFP (7x7)

Base Product Number:

ADS8422

Environmental & Export classification

RoHS Status:

ROHS3 Compliant

REACH Status:

REACH Unaffected

HTSUS:

8542.39.0001

Moisture Sensitivity Level (MSL):

2 (1 Year)

ECCN:

3A991C4



16-BIT, 4-MSPS, PSEUDO-BIPOLAR, FULLY DIFFERENTIAL INPUT, MICROPOWER SAMPLING ANALOG-TO-DIGITAL CONVERTER WITH PARALLEL INTERFACE, REFERENCE

FEATURES

- Fully Differential Input with Pseudo-Bipolar Input Range -4 V to +4 V
- 16-Bit NMC at 4 MSPS
- 1 LSB INL Typ
- 92dB SNR, -102dB THD Typ with 100-kHz Input
- Internal 4.096-V Reference and Reference Buffer
- REFIN/2 Available for Setting Analog Input Common-Mode Voltage
- Zero Latency
- High-Speed Parallel Interface
- Single Supply Operation Capability
- Low Power: 155 mW at 4 MHz Typ, Flexible Power-Down Scheme
- Pin-Out Similar to ADS8412/8402
- 48-Pin 9×9 TQFP Package

APPLICATIONS

- DWDM
- Instrumentation
- High-Speed, High-Resolution, Zero Latency Data Acquisition Systems
- Transducer Interface
- Medical Instruments
- Spectrum Analysis
- ATE

DESCRIPTION

The ADS8422 is a 16-bit, 4-MHz A/D converter with an internal 4.096-V reference. The device includes a 16-bit capacitor-based multi-bit SAR A/D converter with inherent sample and hold. This converter includes a full 16-bit interface and an 8-bit option where data is read using two 8-bit read cycles if necessary.

The ADS8422 has a fully differential, pseudo-bipolar input. It is available in a 48-lead TQFP package and is characterized over the industrial -40°C to +85°C temperature range.

HIGH-SPEED SAR CONVERTER FAMILY⁽¹⁾

| TYPE/SPEED | 500 kHz | ~600 kHz | 750 kHz | 1 MHz | 1.25 MHz | 2 MHz | 3 MHz | 4MHz |
|-----------------------------------|----------------|-------------|---------|----------------|-------------|-------------|---------|---------|
| 18-Bit Pseudo-Diff | ADS8383 | ADS8381 | | ADS8481 | | | | |
| | | ADS8380 (s) | | | | | | |
| 18-Bit Pseudo-Bipolar, Fully Diff | | ADS8382 (s) | | ADS8482 | | | | |
| 16-Bit Pseudo-Diff | | ADS8370 (s) | ADS8371 | ADS8471 | ADS8401 | ADS8411 | | |
| | ADS8327/28 (s) | ADS8372 (s) | | ADS8329/30 (s) | ADS8405 | ADS8410 (s) | | |
| 16-Bit Pseudo-Bipolar, Fully Diff | | | | ADS8472 | ADS8402 | ADS8412 | | ADS8422 |
| | | | | | ADS8406 | ADS8413 (s) | | |
| 14-Bit Pseudo-Diff | | | | | ADS7890 (s) | | ADS7891 | |
| 12-Bit Pseudo-Diff | | | | ADS7886 | | ADS7883 | | ADS7881 |

(1) S: Serial

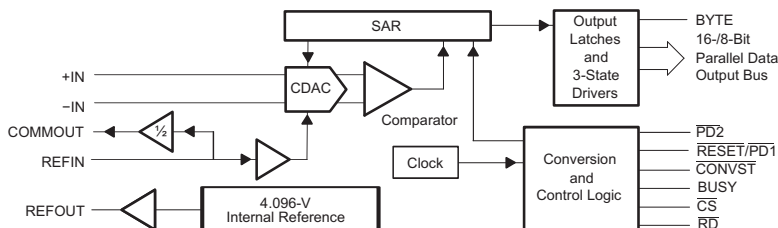

Please be aware that an important notice concerning availability, standard warranty, and use in critical applications of Texas Instruments semiconductor products and disclaimers thereto appears at the end of this data sheet.



These devices have limited built-in ESD protection. The leads should be shorted together or the device placed in conductive foam during storage or handling to prevent electrostatic damage to the MOS gates.

ORDERING INFORMATION⁽¹⁾

| MODEL | MAXIMUM INTEGRAL LINEARITY (LSB) | MAXIMUM DIFFERENTIAL LINEARITY (LSB) | NO MISSING CODES RESOLUTION (BIT) | PACKAGE TYPE | PACKAGE DESIGNATOR | TEMPERATURE RANGE | ORDERING INFORMATION | TRANSPORT MEDIA QTY. |
|-----------|----------------------------------|--------------------------------------|-----------------------------------|-----------------|--------------------|-------------------|----------------------|-------------------------|
| ADS8422I | ±6 | ±2 | 15 | 9×9 48-Pin TQFP | PFB | –40°C to 85°C | ADS8422IPFBT | Small tape and reel 250 |
| | | | | | | | ADS8422IPFBR | Tape and reel 1000 |
| ADS8422IB | ±2 | +1.5/-1 | 16 | 9×9 48-Pin TQFP | PFB | –40°C to 85°C | ADS8422IBPFBT | Small tape and reel 250 |
| | | | | | | | ADS8422IBPFBR | Tape and reel 1000 |

(1) For the most current package and ordering information, see the Package Option Addendum at the end of this document, or see the TI website at www.ti.com.

ABSOLUTE MAXIMUM RATINGS⁽¹⁾

over operating free-air temperature range (unless otherwise noted)

| | | VALUE | UNIT |
|---|--------------------------------------|--|------|
| Voltage | +IN to AGND | –0.4 to +VA + 0.1 | V |
| | –IN to AGND | –0.4 to +VA + 0.1 | V |
| | +VA to AGND | –0.3 to 7 | V |
| | +VBD to BDGND | –0.3 to 7 | V |
| Digital input voltage to BDGND | | –0.3 to +VBD + 0.3 | V |
| Digital output voltage to BDGND | | –0.3 to +VBD + 0.3 | V |
| T _A | Operating free-air temperature range | –40 to 85 | °C |
| T _{stg} | Storage temperature range | –65 to 150 | °C |
| Junction temperature (T _J max) | | 150 | °C |
| TQFP 48-pin package | Power dissipation | (T _J Max – T _A)/θ _{JA} | |
| | θ _{JA} thermal impedance | 86 | °C/W |
| Lead temperature, soldering | Vapor phase (60 sec) | 215 | °C |
| | Infrared (15 sec) | 220 | °C |

(1) Stresses beyond those listed under *absolute maximum ratings* may cause permanent damage to the device. These are stress ratings only, and functional operation of the device at these or any other conditions beyond those indicated under *recommended operating conditions* is not implied. Exposure to absolute-maximum-rated conditions for extended periods may affect device reliability.

SPECIFICATIONS

$T_A = -40^\circ\text{C}$ to 85°C , $+V_A = 5\text{ V}$, $+V_{\text{AREG}} = 5\text{ V}$ to 3 V , $+V_{\text{BD}} = 5\text{ V}$ to 2.7 V , $f_{\text{SAMPLE}} = 4\text{ MSPS}$, $V_{\text{ref}} = 4.096\text{ V}$ (measured with internal reference buffer) (unless otherwise noted)

| PARAMETER | | TEST CONDITIONS | MIN | TYP | MAX | UNIT |
|---|--|--|----------------------------|----------------------|----------------------------|--------------------------------|
| ANALOG INPUT | | | | | | |
| Full-scale input voltage ⁽¹⁾ | | +IN – (–IN) | $-V_{\text{ref}}$ | | V_{ref} | V |
| Absolute input voltage | | +IN | –0.2 | | $V_{\text{ref}} + 0.2$ | V |
| | | –IN | –0.2 | | $V_{\text{ref}} + 0.2$ | |
| Common-mode input range | | | $(V_{\text{ref}})/2 - 0.2$ | $(V_{\text{ref}})/2$ | $(V_{\text{ref}})/2 + 0.2$ | V |
| Input capacitance | | | | 30 | | pF |
| Input leakage current | | | | | 1 | nA |
| SYSTEM PERFORMANCE | | | | | | |
| Resolution | | | | 16 | | Bits |
| No missing codes | | ADS8422I | 15 | | | Bits |
| | | ADS8422IB | 16 | | | |
| Integral linearity ⁽²⁾⁽³⁾ | | ADS8422I | –6 | ± 2 | 6 | LSB (16 bit) ⁽²⁾ |
| | | ADS8422IB | –2 | ± 1 | 2 | |
| Differential linearity | | ADS8422I | –2 | ± 0.7 | 2 | LSB (16 bit) |
| | | ADS8422IB | –1 | ± 0.7 | 1.5 | |
| Offset error | | | –0.5 | ± 0.25 | 0.5 | mV |
| Offset error drift | | | | ± 0.2 | | ppm/ $^\circ\text{C}$ |
| Gain error ⁽⁴⁾⁽⁵⁾ | | $V_{\text{ref}} = 4.096\text{ V}$ | –0.1 | ± 0.05 | 0.1 | %FS |
| Gain error drift | | $V_{\text{ref}} = 4.096\text{ V}$ | | ± 2 | | ppm/ $^\circ\text{C}$ |
| Common-mode rejection ratio | | At dc | | 81 | | dB |
| | | At code 0000h with $[+IN + (-IN)]/2 = 512\text{ mV}_{\text{pp}}$ at 500 kHz, | | 78 | | |
| Noise | | At 0000h output code | | 40 | | $\mu\text{V RMS}$ |
| Power supply rejection ratio | | At 8000h output code | | 78 | | dB |
| SAMPLING DYNAMICS | | | | | | |
| Conversion time | | | | | 0.180 | μs |
| Acquisition time | | | 0.070 | | | μs |
| Throughput rate | | | | | 4 | MHz |
| Aperture delay | | | | 3 | | ns |
| Aperture jitter | | | | 7 | | ps RMS |
| Step response | | | | 70 | | ns |
| Overvoltage recovery | | | | 140 | | ns |

- (1) Ideal input span, does not include gain or offset error.
- (2) LSB means least significant bit and is equal to $2V_{\text{REF}}/65536$.
- (3) This is endpoint INL, not best fit.
- (4) Measured relative to an ideal full-scale input $[+IN - (-IN)]$ of 8.192 V.
- (5) This specification does not include the internal reference voltage error and drift.

SPECIFICATIONS (Continued)

$T_A = -40^{\circ}\text{C}$ to 85°C , $+VA = 5\text{ V}$, $+VAREG = 5.25\text{ V}$ to 3 V , $+VBD = 5\text{ V}$ to 2.7 V , $f_{\text{SAMPLE}} = 4\text{ MSPS}$, $V_{\text{ref}} = 4.096\text{ V}$ (measured with internal reference buffer) (unless otherwise noted)

| PARAMETER | TEST CONDITIONS | MIN | TYP | MAX | UNIT |
|---|---|----------------------------|--------------------|----------------------------|--------|
| DYNAMIC CHARACTERISTICS | | | | | |
| Total harmonic distortion (THD) ⁽¹⁾ | $V_{\text{IN}} = 8\text{ V}_{\text{pp}}$ | 10 kHz | -114 | | dB |
| | | 100 kHz | -102 | | |
| | | 500 kHz | -100 | | |
| Signal to noise ratio (SNR) | $V_{\text{IN}} = 8\text{ V}_{\text{pp}}$ | 10 kHz | 93 | | dB |
| | | 100 kHz | 92 | | |
| | | 500 kHz | 90 | | |
| Signal to noise + distortion (SINAD) | $V_{\text{IN}} = 8\text{ V}_{\text{pp}}$ | 10 kHz | 92.5 | | dB |
| | | 100 kHz | 91.5 | | |
| | | 500 kHz | 89.5 | | |
| Spurious free dynamic range (SFDR) | $V_{\text{IN}} = 8\text{ V}_{\text{pp}}$ | 10 kHz | 116 | | dB |
| | | 100 kHz | 109 | | |
| | | 500 kHz | 106 | | |
| -3dB Small signal bandwidth | | | 30 | | MHz |
| Maximum input frequency, $f_{i(\text{max})}$ ⁽²⁾ | $V_{\text{IN}} = 8\text{ V}_{\text{pp}}$ | 2 | | | MHz |
| VOLTAGE REFERENCE INPUT | | | | | |
| Reference voltage at REFIN, V_{ref} | | 3.9 | 4.096 | 4.15 | V |
| Reference resistance | | | 1000 | | MΩ |
| INTERNAL REFERENCE OUTPUT | | | | | |
| Internal reference start-up time | From 95% (+VA), with 1-μF capacitor on REFOUT | | | 25 | ms |
| Reference voltage range, V_{ref} | $I_O = 0$, $T_A = 25^{\circ}\text{C}$ | 4.088 | 4.096 | 4.104 | V |
| Source current | Static load | | | 10 | μA |
| Line regulation | $+VA = 4.75\text{ V}$ to 5.25 V | | ±1 | | mV |
| Drift | $I_O = 0$ | | ±6 | | PPM/°C |
| ANALOG COMMON-MODE, PIN 3 | | | | | |
| Output voltage range | $I_O = 0$ | $V_{\text{REF}}/2 - 0.016$ | $V_{\text{REF}}/2$ | $V_{\text{REF}}/2 + 0.016$ | V |
| Source current | Static load | | 200 | | μA |

(1) Calculated on the first nine harmonics of the input frequency.

(2) ADC Sampling circuit is optimized to accept inputs until Nyquist frequency. Dynamic performance may degrade rapidly above $f_{i(\text{max})}$.

SPECIFICATIONS (Continued)

$T_A = -40^\circ\text{C}$ to 85°C , $+VA = 5\text{ V}$, $+VAREG = 5\text{ V}$ to 3 V , $+VBD = 5\text{ V}$ to 2.7 V , $f_{\text{SAMPLE}} = 4\text{ MSPS}$, $V_{\text{ref}} = 4.096\text{ V}$ (measured with internal reference buffer) (unless otherwise noted)

| PARAMETER | | TEST CONDITIONS | MIN | TYP | MAX | UNIT | |
|----------------------------------|---------------------|---|----------------------|-----|--------------|------------------|---------------|
| DIGITAL INPUT/OUTPUT | | | | | | | |
| Logic family – CMOS | | | | | | | |
| Logic level | V_{IH} | $I_{\text{IH}} = 5\ \mu\text{A}$ | $0.75 \times (+VBD)$ | | $+VBD + 0.3$ | V | |
| | V_{IL} | $I_{\text{IL}} = 5\ \mu\text{A}$ | -0.3 | | 0.8 | | |
| | V_{OH} | $I_{\text{OH}} = 2\text{ TTL loads}$ | $+VBD - 0.6$ | | | | |
| | V_{OL} | $I_{\text{OL}} = 2\text{ TTL loads}$ | | | 0.4 | | |
| Data format – Twos complement | | | | | | | |
| POWER SUPPLY REQUIREMENTS | | | | | | | |
| Power supply voltage | +VA | | 4.75 | 5 | 5.25 | V | |
| | +VAREG | | 2.85 | 3.0 | 5.25 | | |
| | +VBD | | 2.7 | 3.0 | 5.25 | | |
| Supply current | +VA | $+VA = 5\text{ V}$, $\overline{\text{PD1}} = 1$, $\overline{\text{PD2}} = 1$ | | 24 | 27 | mA | |
| | +VAREG | $+VAREG = 5\text{ V}$, $\overline{\text{PD1}} = 1$, $\overline{\text{PD2}} = 1$ | | 12 | 14 | mA | |
| | | $+VAREG = 3\text{ V}$, $\overline{\text{PD1}} = 1$, $\overline{\text{PD2}} = 1$ | | 12 | 14 | | |
| | +VBD ⁽¹⁾ | $+VBD = 3\text{ V}$, 10 pF/pin | | | 0.55 | mA | |
| $+VBD = 5\text{ V}$, 20 pF/pin | | | | 1.8 | | | |
| POWER DOWN⁽²⁾ | | | | | | | |
| Supply current | +VA | $\overline{\text{PD1}} = 0$, $\overline{\text{PD2}} = 1$, $+VA = 5\text{ V}$ | | 2.5 | 3.4 | mA | |
| | +VAREG | | | 5 | | μA | |
| Power | | | | | | 17 | mW |
| Power-up time | | $(\overline{\text{PD1}}, \overline{\text{PD2}}) : (0,1) \rightarrow (1,1)$ | | | 5 | μs | |
| Supply current | +VA | $\overline{\text{PD1}} = 0$, $\overline{\text{PD2}} = 0$ | | 5 | | μA | |
| | +VAREG | | | 5 | | | |
| Power | | | | | | 40 | μW |
| Power-up time | | $(\overline{\text{PD1}}, \overline{\text{PD2}}) : (0,0) \rightarrow (1,1)$, 1- μF Storage capacitor from REFOUT to AGND | | | 25 | ms | |
| TEMPERATURE RANGE | | | | | | | |
| Operating free-air | | | -40 | | 85 | $^\circ\text{C}$ | |

- (1) This includes the current required for charging the external load capacitance on the digital outputs and is measured with four digital outputs toggling at the same time.
 (2) $(\overline{\text{PD1}}, \overline{\text{PD2}}) = (1,0)$ is reserved. Do not use this power-down pins combination.

TIMING CHARACTERISTICS FROM DIGITAL INPUTS

All specifications typical at –40°C to 85°C, +VBD = 2.7 V to 5.25 V ⁽¹⁾⁽²⁾

| PARAMETER | | MIN | TYP | MAX | UNIT |
|-----------------------------------|---|--|------|-----|------|
| CONVERSION AND ACQUISITION | | | | | |
| $t_{(ACQ)}$ | Acquisition time, internal to device, not externally visible | 70 | | | ns |
| t_{w1} | Pulse duration, \overline{CONVST} low | 20 | | | ns |
| t_{w2} | Pulse duration, \overline{CONVST} high | 100 | | | ns |
| t_{p1} | Period, \overline{CONVST} | 250 | | | ns |
| t_{q1} | Quiet time, last toggle of interface input signals during acquisition before \overline{CONVST} falling ⁽³⁾ | 30 | | | ns |
| t_{q2} | Quiet time, \overline{CONVST} falling to first toggle of interface input signals ⁽³⁾ | 10 | | | ns |
| POWER DOWN | | | | | |
| t_{w3} | Pulse duration | $\overline{PD1}$ low for only ADC reset (no powerdown) | 20 | 500 | ns |
| | | $\overline{PD1}$ low for ADC reset and also ADC powerdown | 1500 | | |
| | | $\overline{PD2}$ low pulse duration for REFOUT and COMMOUT buffers powerdown | 1500 | | |
| | Pulse duration, all others unspecified | 10 | | | ns |

- (1) All input signals are specified with $t_r = t_f = 5$ ns (10% to 90% of V_{DD}) and timed from after 90% of transition.
- (2) All digital output signals loaded with 10-pF capacitors at +VBD = 2.7 V and 20-pF capacitor at +VBD = 5.25 V and timed to reaching 90% of transition.
- (3) Quiet time zones are for meeting performance and not functionality.

TIMING CHARACTERISTICS OF DIGITAL OUTPUTS

All specifications typical at –40°C to 85°C, +VBD = 2.7 V to 5.25 V ⁽¹⁾⁽²⁾

| PARAMETER | | MIN | TYP | MAX | UNIT |
|-----------------------------------|---|-----|-----|-----|---------|
| CONVERSION AND ACQUISITION | | | | | |
| $t_{(CONV)}$ | Conversion time, internal to device, not externally visible | | | 180 | ns |
| t_{d1} | Delay time, \overline{CONVST} fall to conversion start (aperture delay) | | 3 | | ns |
| DATA READ OPERATION | | | | | |
| t_{d2} | Delay time, \overline{CONVST} low to data valid if $\overline{CS} = \overline{RD} = 0$ | | | 225 | ns |
| t_{d3} | Delay time, data valid to BUSY low if $\overline{CS} = \overline{RD} = 0$ | 5 | | | ns |
| t_{d4} | Delay time, \overline{RD} (or \overline{CS}) low to data valid | | | 17 | ns |
| t_{d5} | Delay time, BYTE toggle to data valid | | | 20 | ns |
| t_{d6} | Delay time, data three-state after \overline{RD} (or \overline{CS}) high | | | 12 | ns |
| POWER DOWN | | | | | |
| t_{d7} | Delay time, $\overline{PD1}$ low to BUSY rising | | | 20 | ns |
| t_{d8} | Delay time, $\overline{PD1}$ high to device operational (with $\overline{PD2}$ held high) | | | 5 | μ s |
| | Delay time, $\overline{PD2}$ high to REFOUT/COMMOUT valid | | | 25 | ms |
| | Delay time, power up (after $AV_{DD} = 4.75$ V) | | | 25 | ms |
| t_{d9} | Delay time, data three-state after $\overline{PD1}$ low | | | 1.5 | μ s |

- (1) All input signals are specified with $t_r = t_f = 5$ ns (10% to 90% of V_{DD}) and timed from after 90% of transition.
- (2) All digital output signals loaded with 10-pF capacitors at +VBD = 2.7 V and 20-pF capacitor at +VBD = 5.25 V and timed to reaching 90% of transition.

PIN ASSIGNMENTS

PFB Package (Top View)

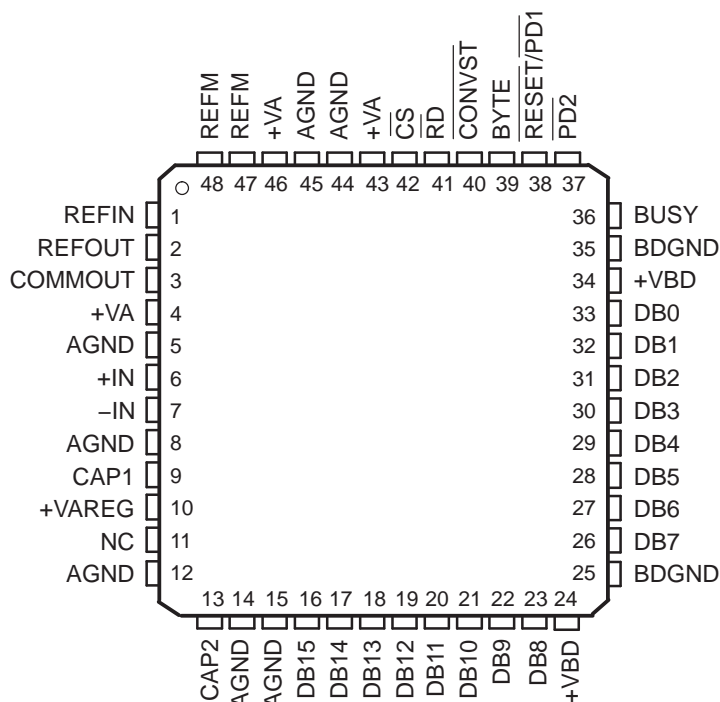

- A. NC - No connection
- B. Pins 9 and 13 are internally regulated 3-V outputs and are externally to be connected to decoupling capacitors only.
- C. +VAREG can be connected to a 3-V to 5-V supply.
- D. Pin 3 outputs REFIN/2
- E. Pin 38 can be used for ADC powerdown and pin 37 for analog output powerdown.

TERMINAL FUNCTIONS

| NAME | NO | I/O | DESCRIPTION | | |
|------------|--------------------------|-----|---|----------|------------|
| AGND | 5, 8, 12, 14, 15, 44, 45 | – | Analog ground | | |
| BDGND | 25, 35 | – | Digital ground for bus interface digital supply | | |
| BUSY | 36 | O | Status output. High when a conversion is in progress. | | |
| BYTE | 39 | I | Byte select input. Used for 8-bit bus reading. 0: No fold back 1: Low byte D[7:0] of the 16 most significant bits is folded back to high byte of the 16 most significant pins DB[15:8]. | | |
| COMMOUT | 3 | O | This pin outputs REFIN/2 and can be used to set the common-mode voltage of the differential analog input, (+IN + –IN)/2. | | |
| CONVST | 40 | I | Convert start. This input is low true and can act independent of the CS input. | | |
| CS | 42 | I | Chip select. | | |
| CAP1, CAP2 | 9, 13 | O | Decoupling of internally generated 3-V supply. Add 1-μF capacitor from these pins to AGND. | | |
| Data Bus | | | 8-BIT BUS | | 16-BIT BUS |
| | | | BYTE = 0 | BYTE = 1 | BYTE = 0 |
| DB15 | 16 | O | D15 (MSB) | D7 | D15 (MSB) |
| DB14 | 17 | O | D14 | D6 | D14 |
| DB13 | 18 | O | D13 | D5 | D13 |
| DB12 | 19 | O | D12 | D4 | D12 |
| DB11 | 20 | O | D11 | D3 | D11 |
| DB10 | 21 | O | D10 | D2 | D10 |

TERMINAL FUNCTIONS (continued)

| NAME | NO | I/O | DESCRIPTION | | |
|-------------------------------|--------|-----|---|----------|----------|
| DB9 | 22 | O | D9 | D1 | D9 |
| DB8 | 23 | O | D8 | D0 (LSB) | D8 |
| DB7 | 26 | O | D7 | All ones | D7 |
| DB6 | 27 | O | D6 | All ones | D6 |
| DB5 | 28 | O | D5 | All ones | D5 |
| DB4 | 29 | O | D4 | All ones | D4 |
| DB3 | 30 | O | D3 | All ones | D3 |
| DB2 | 31 | O | D2 | All ones | D2 |
| DB1 | 32 | O | D1 | All ones | D1 |
| DB0 | 33 | O | D0 (LSB) | All ones | D0 (LSB) |
| –IN | 7 | I | Inverting input channel | | |
| +IN | 6 | I | Noninverting input channel | | |
| NC | 11 | – | No connection | | |
| $\overline{\text{PD2}}$ | 37 | I | Low true signal. A logic low longer than 1.5 μs applied to this pin powers down only the analog outputs that include REFOUT and COMMOUT. (NOTE: The combination $\overline{\text{PD1}} = 1$, $\overline{\text{PD2}} = 0$ is reserved. Do not use this combination.) | | |
| REFIN | 1 | I | Reference input. Add 0.1- μF decoupling capacitor between REFIN and REFM. | | |
| REFOUT | 2 | O | Reference output. Add 1- μF capacitor between the REFOUT pin and REFM pin when internal reference is used. | | |
| REFM | 47, 48 | I | Reference ground | | |
| $\overline{\text{RESET/PD1}}$ | 38 | I | Low true signal. A low pulse applied to this pin resets the ADC; the ongoing conversion is aborted. A low pulse shorter than 0.5 μs only resets, and one longer than 1.5 μs resets and also powers down the ADC. Note that analog outputs REFOUT and COMMOUT can be powered down by $\overline{\text{PD2}}$, if necessary. | | |
| $\overline{\text{RD}}$ | 41 | I | Synchronization pulse for the parallel output. | | |
| +VA | 4, 46 | – | Analog power supplies, 4.75 V to 5.25 VDC | | |
| +VAREG | 10 | – | Regulator supply, 2.85 V to 5.25 VDC | | |
| +VBD | 24, 34 | – | Digital power supply for bus | | |

TYPICAL CHARACTERISTICS

HISTOGRAM OF 262144 CONVERSIONS OF DC INPUT AT CENTER CODE (Internal Reference)

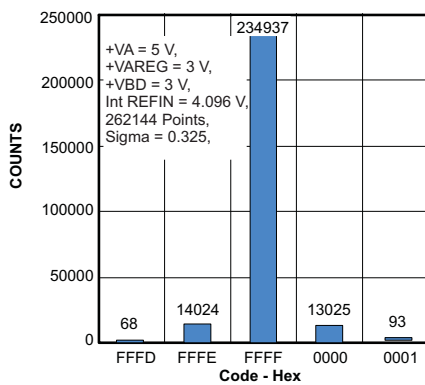

Figure 1.

HISTOGRAM OF 262144 CONVERSIONS OF DC INPUT AT CENTER CODE (External Reference)

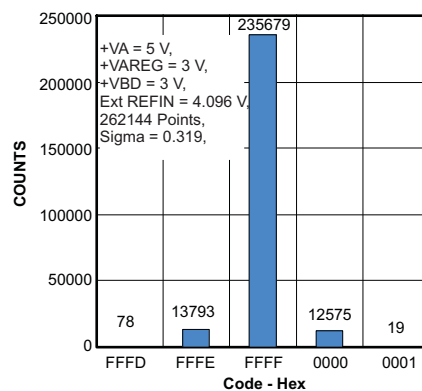

Figure 2.

INTERNAL REFERENCE VOLTAGE vs FREE-AIR TEMPERATURE (Three Devices Shown)

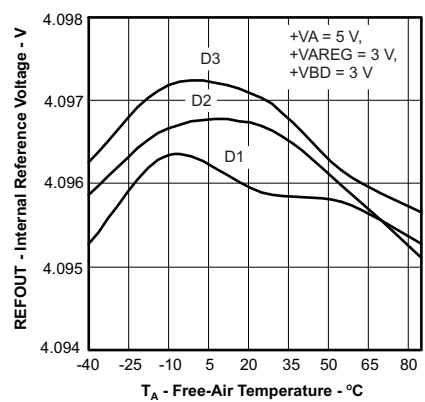

Figure 3.

TYPICAL CHARACTERISTICS (continued)

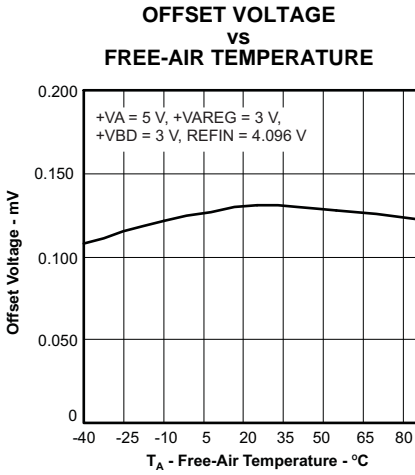

Figure 4.

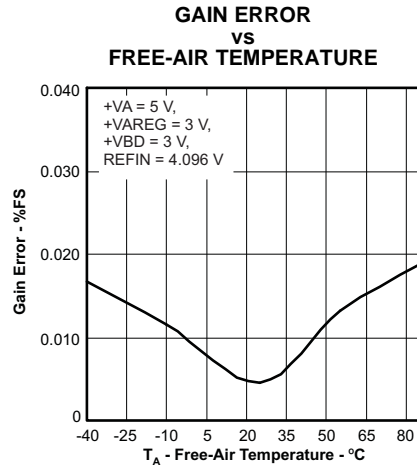

Figure 5.

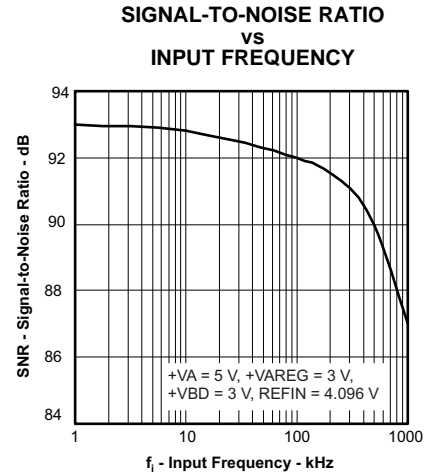

Figure 6.

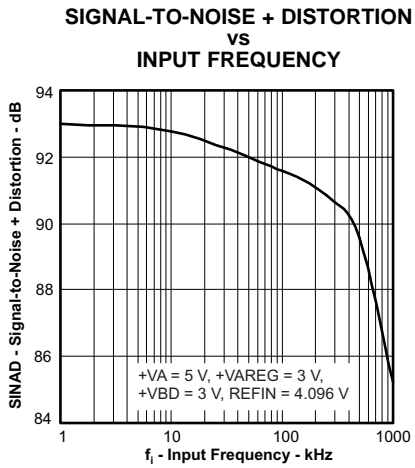

Figure 7.

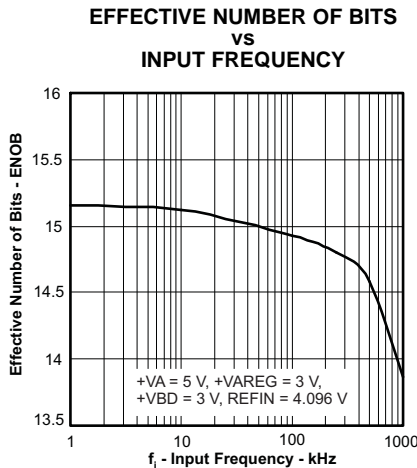

Figure 8.

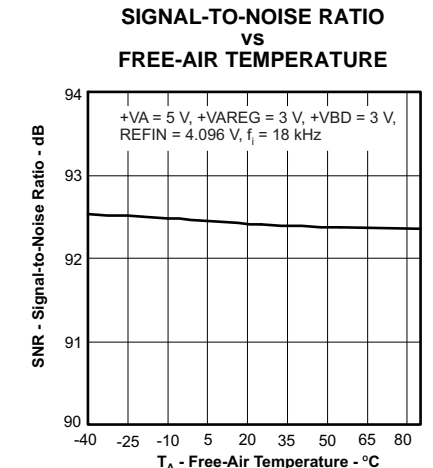

Figure 9.

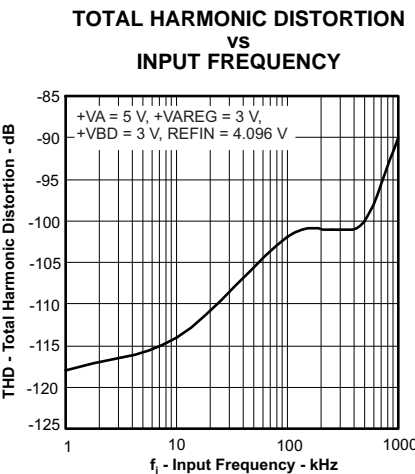

Figure 10.

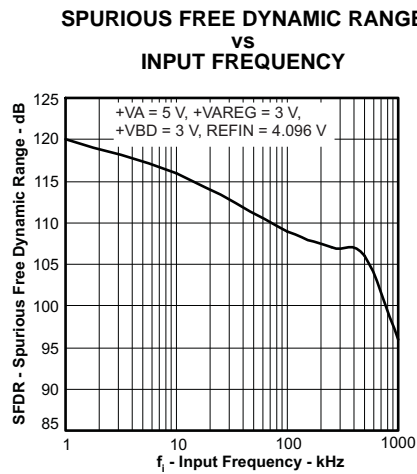

Figure 11.

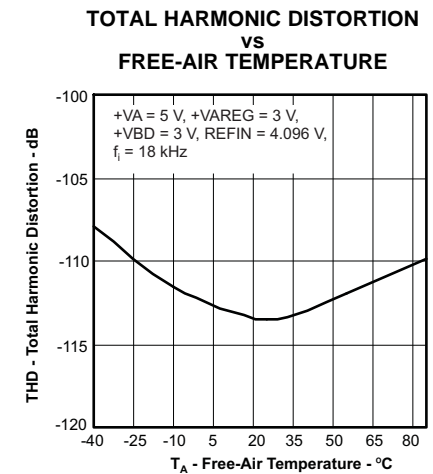

Figure 12.

TYPICAL CHARACTERISTICS (continued)

POWER DISSIPATION
VS
THROUGHPUT

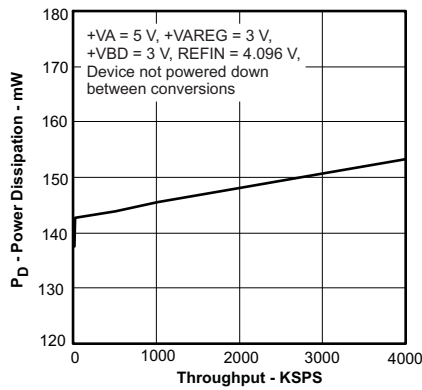

Figure 13.

+VAREG CURRENT
VS
THROUGHPUT

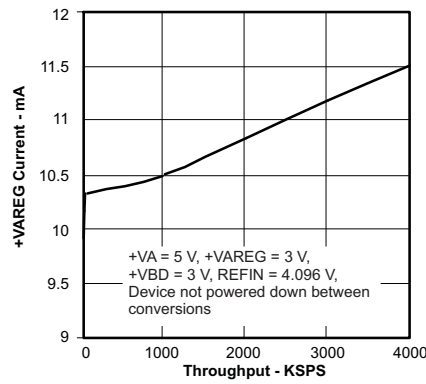

Figure 14.

+VA CURRENT
VS
THROUGHPUT

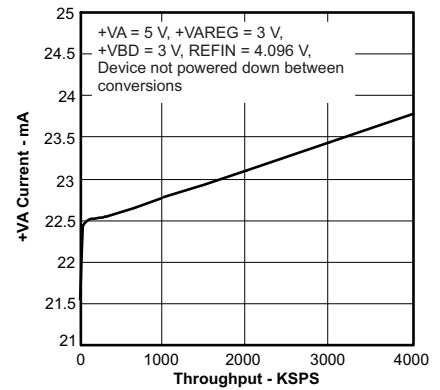

Figure 15.

DIFFERENTIAL NONLINEARITY
VS
FREE-AIR TEMPERATURE

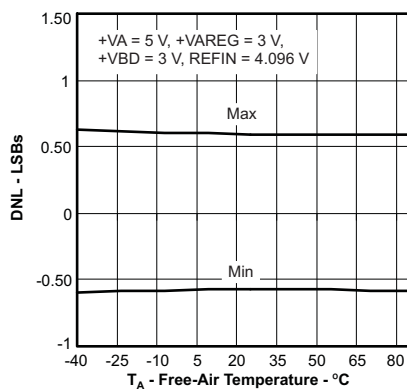

Figure 16.

INTEGRAL NONLINEARITY
VS
FREE-AIR TEMPERATURE

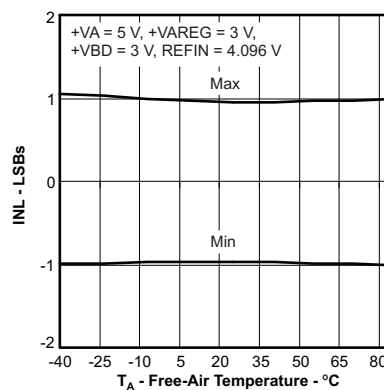

Figure 17.

COMMON-MODE REJECTION RATIO
VS
FREQUENCY

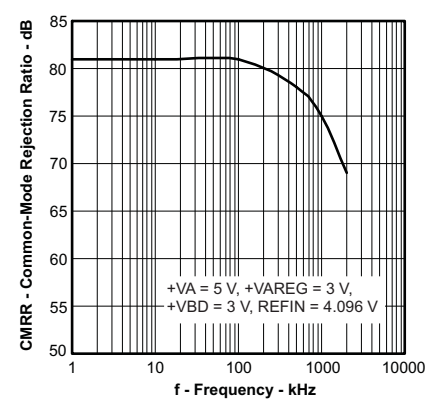

Figure 18.

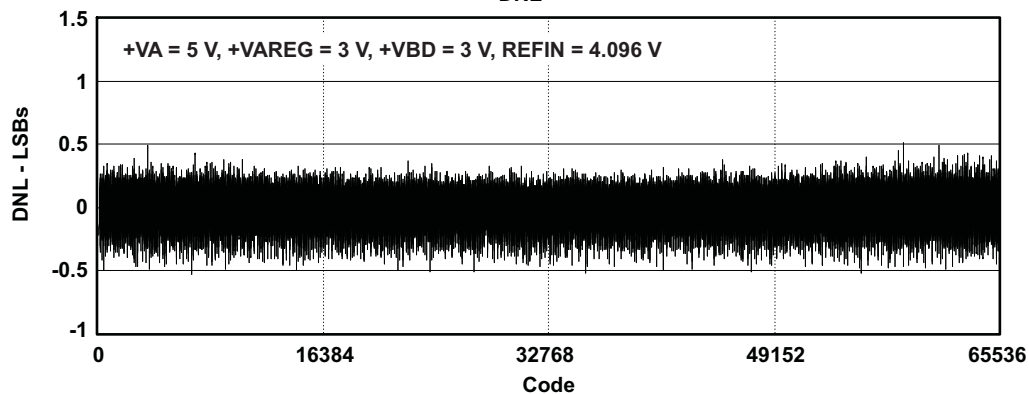

Figure 19.

TYPICAL CHARACTERISTICS (continued)

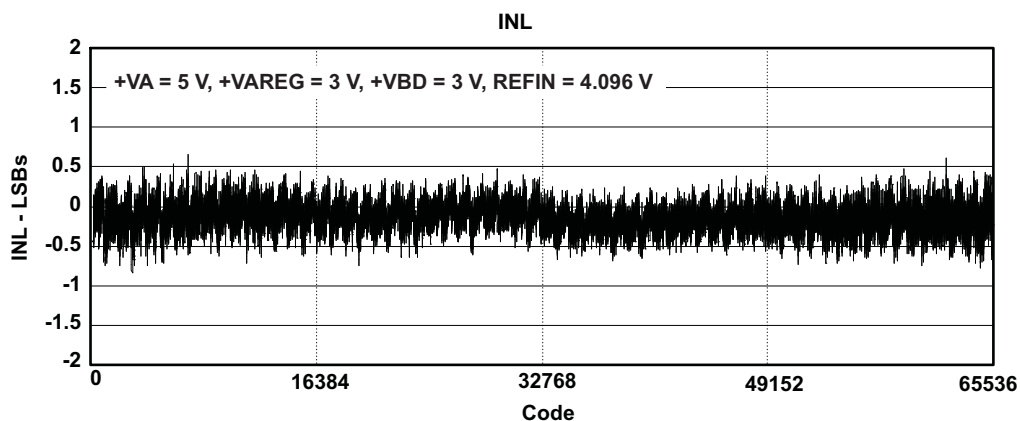

Figure 20.

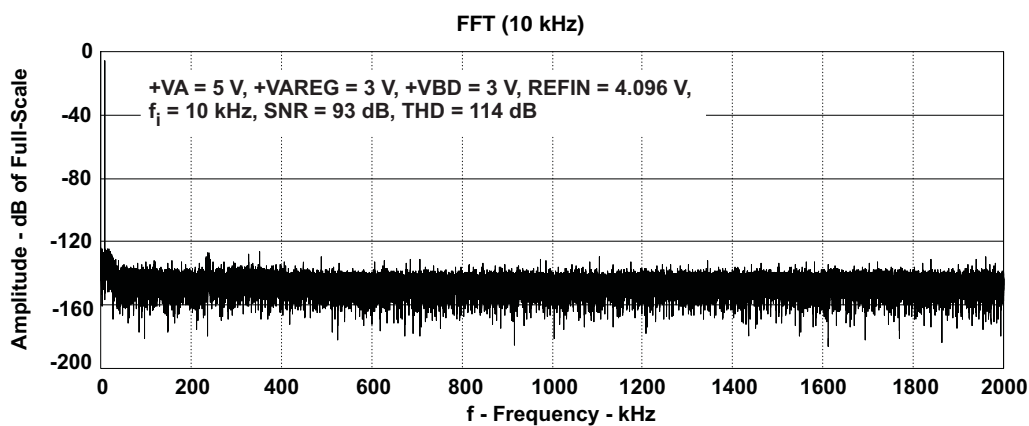

Figure 21.

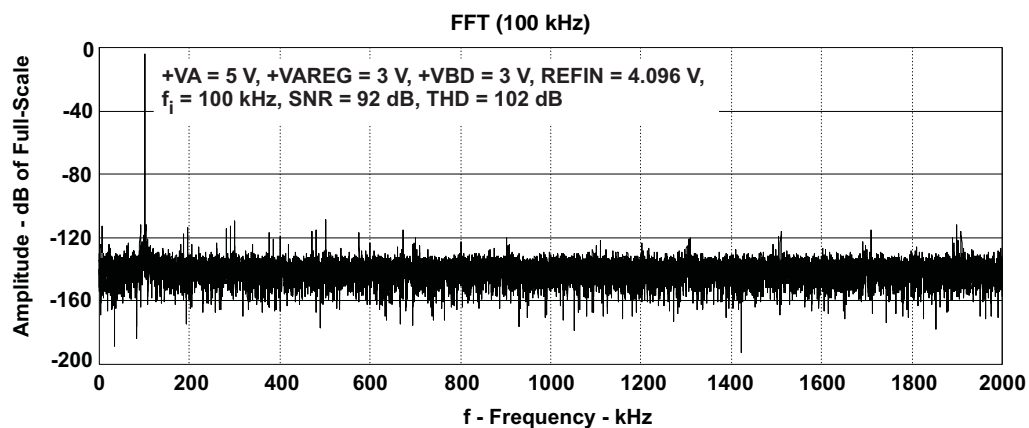
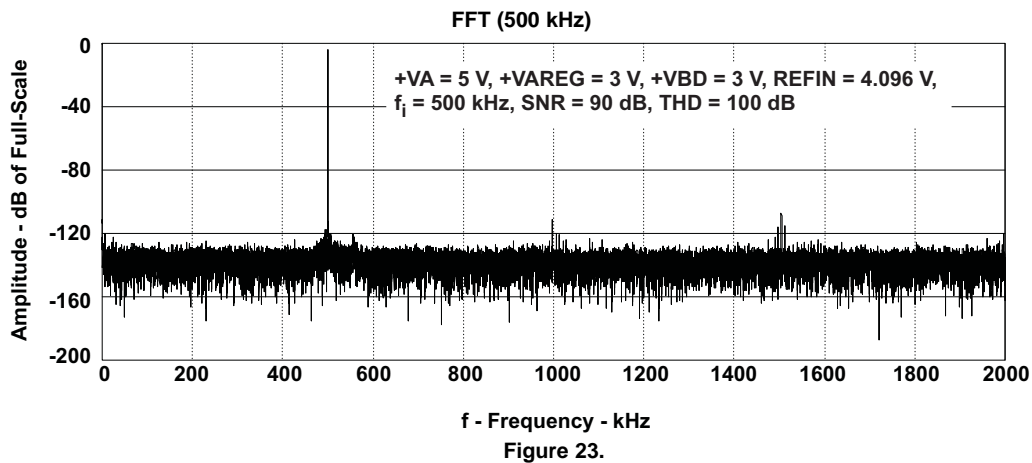
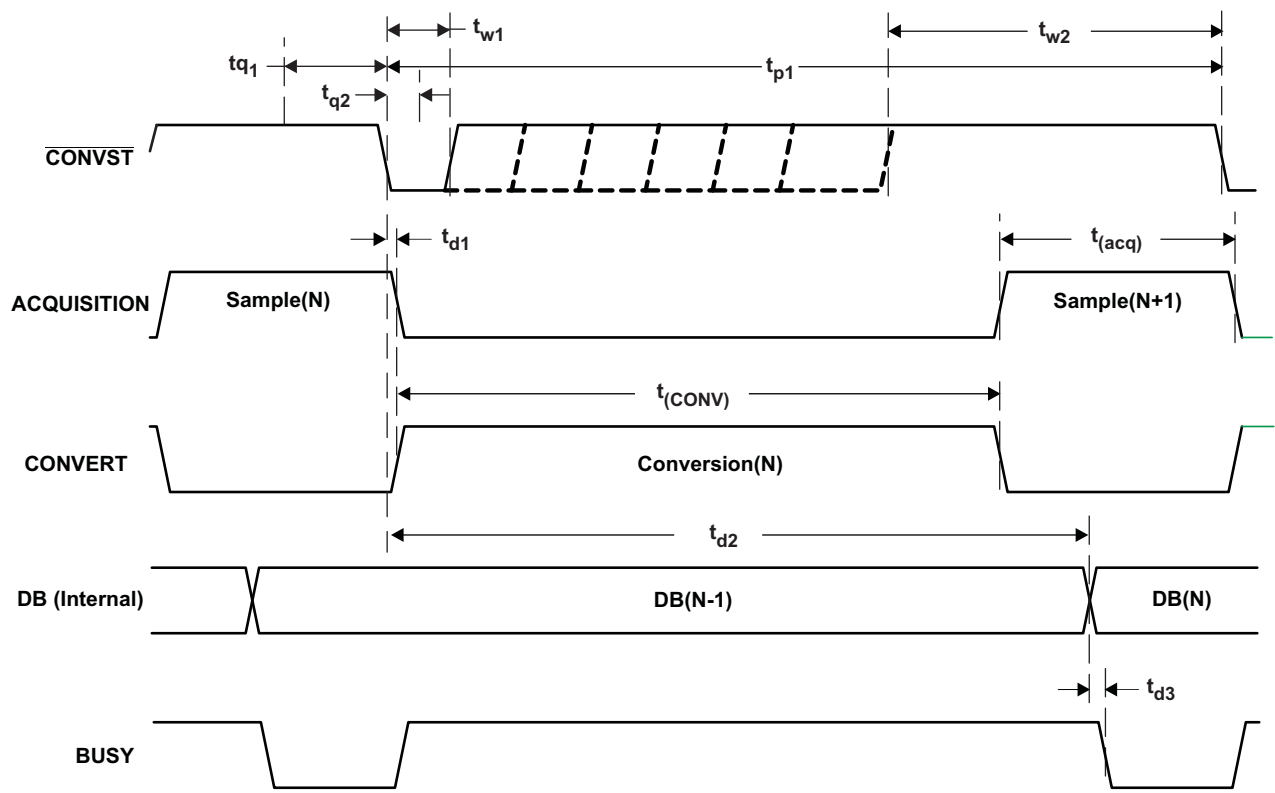

Figure 22.

TYPICAL CHARACTERISTICS (continued)



TIMING DIAGRAMS



Note: The DB shown here is internal to the device and output on the pins only if and when \overline{CS} and \overline{RD} are both low (after t_{d4} ns). This is shown in Figure 25.

Figure 24. Conversion Control Timing

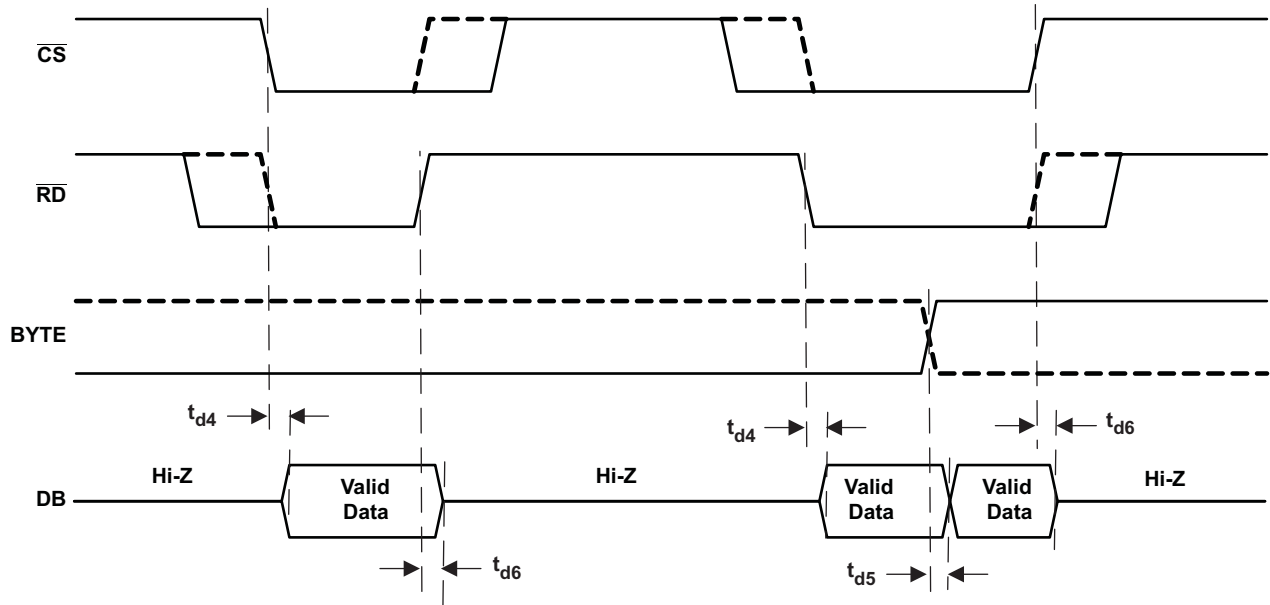

Note: Data is output on the pins only if \overline{CS} and \overline{RD} are both low, t_{d4} ns after this condition is satisfied.

Figure 25. Data Read Timing

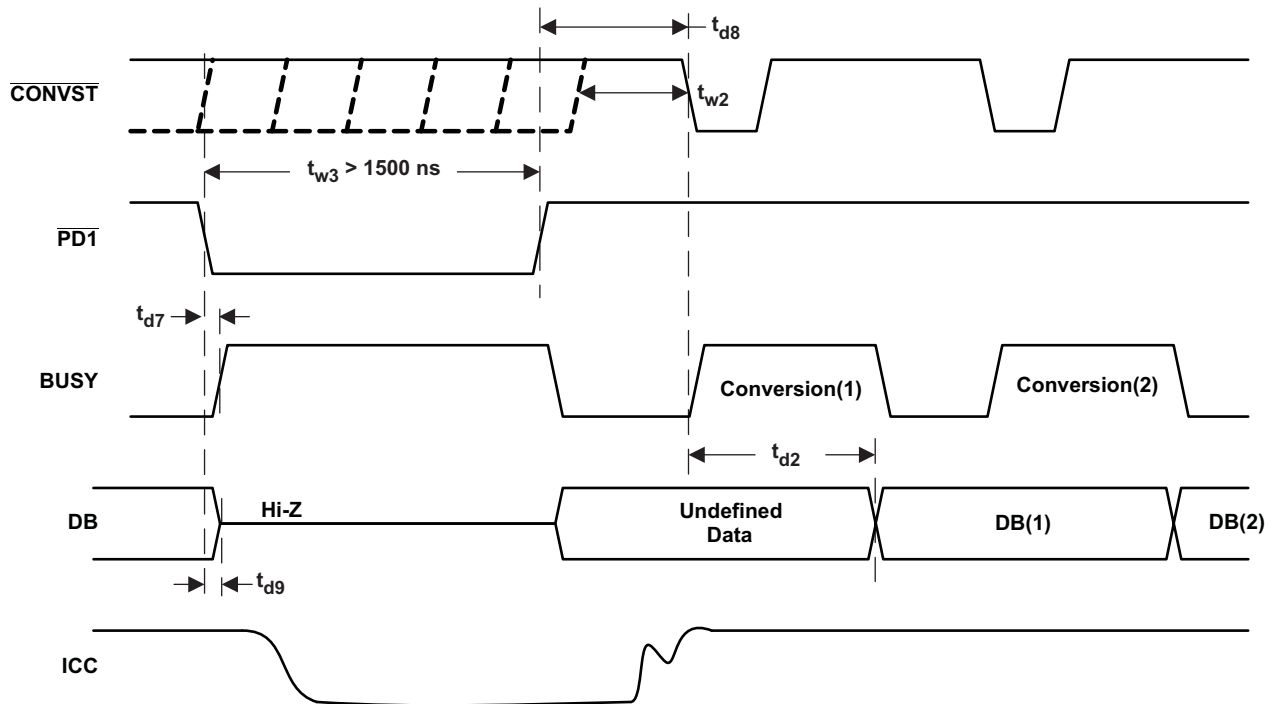

Note: Data is valid from the first conversion initiated 5 μ s after $\overline{PD1}$ is pulled high.

Figure 26. ADC Power-Down Timing

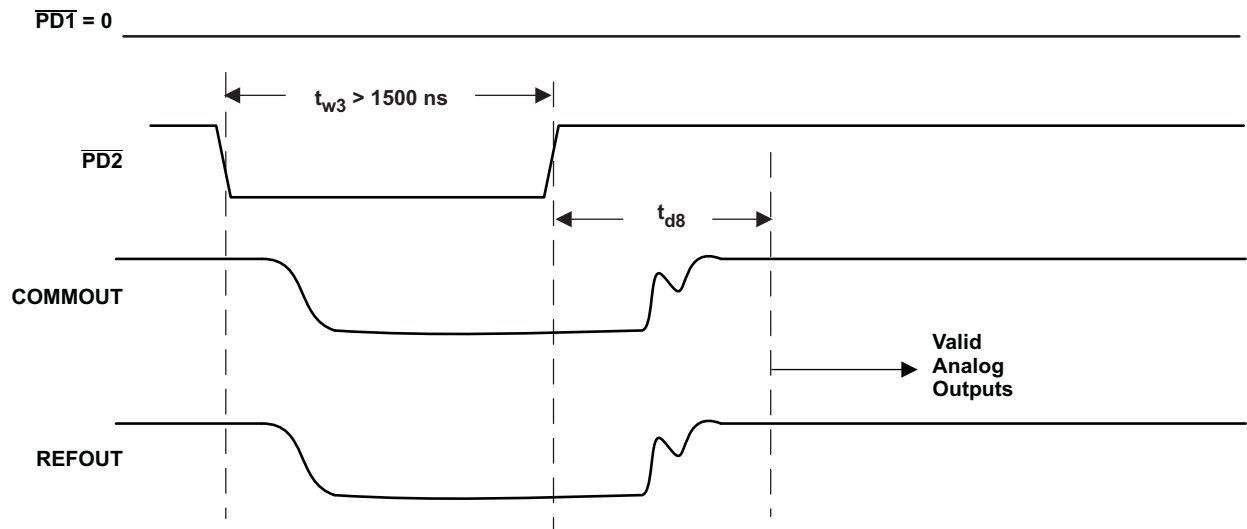

Note: Analog outputs are valid 25 ms after $\overline{\text{PD2}}$ is pulled high.

Figure 27. Analog Output Power-Down Timing

RESET TIMING

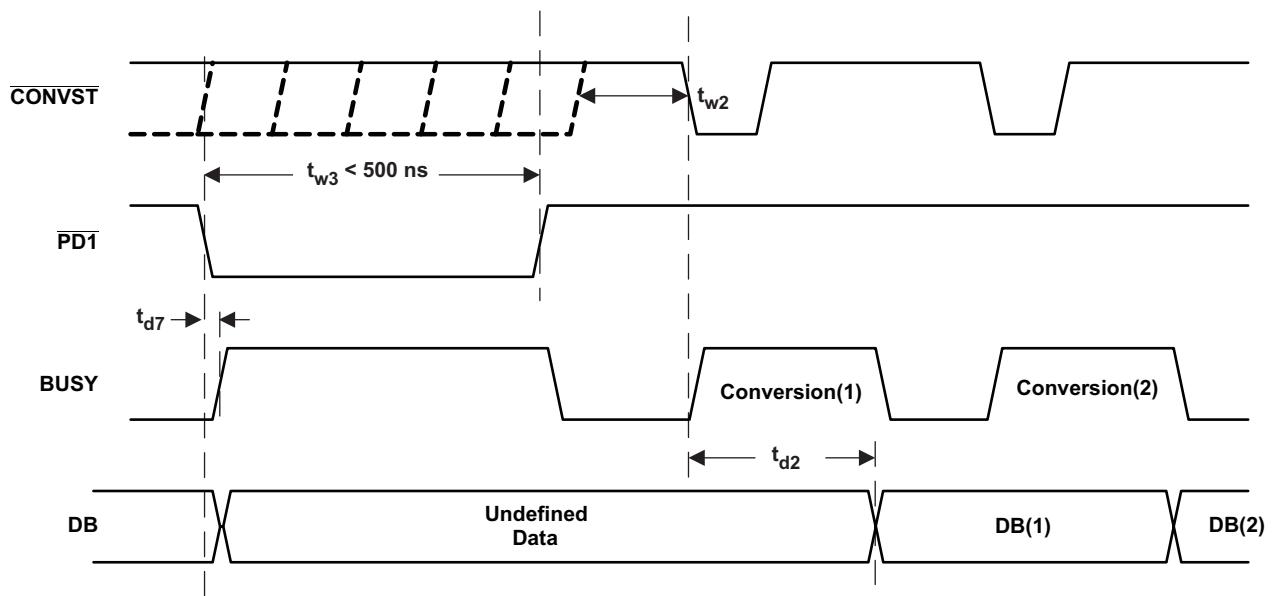

Note: Data valid from first conversion initiated 100 ns after $\overline{\text{PD1}}$ is pulled high.

Figure 28. ADC Reset

PRINCIPLES OF OPERATION

The ADS8422 is a member of a family of high-speed multi-bit successive approximation register (SAR) analog-to-digital converters (ADC). The architecture is based on charge redistribution, which inherently includes a sample/hold function. See [Figure 34](#) for the application circuit for the ADS8422.

The conversion clock is generated internally. The conversion time is a maximum of 180 ns that is capable of sustaining a 4-MHz throughput.

The analog input is provided to two input pins: +IN and -IN. When a conversion is initiated, the differential input on these pins is sampled on the internal capacitor array. While a conversion is in progress, both inputs are disconnected from any internal function.

REFERENCE

The ADS8422 has a built-in 4.096-V reference but can operate with an external 4.096-V reference. When internal reference is used, pin 2 (REFOUT) should be connected to pin 1 (REFIN) with a 0.1- μ F decoupling capacitor and a 1- μ F storage capacitor between pin 2 (REFOUT) and pins 47 and 48 (REFM). The internal reference of the converter is double buffered. If an external reference is used, the second buffer provides isolation between the external reference and the CDAC. This buffer is also used to recharge all of the capacitors of the CDAC during conversion. Pin 2 (REFOUT) can be left unconnected (floating) if an external reference is used.

ANALOG INPUT

The ADS8422 has a pseudo-bipolar, fully differential input. When the input is differential, the amplitude of the input equals the difference between +IN and -IN. The peak-to-peak amplitude of each input is V_{REF} . However since the two inputs are 180° out of phase, the peak-to-peak amplitude of the difference voltage [+IN – (-IN)] is equal to $2V_{REF}$. The common-mode input range is from $V_{REF}/2 - 0.2$ V to $V_{REF}/2 + 0.2$ V.

In order to avoid additional external circuitry on the board, the ADS8422 outputs reference input on REFIN divided by 2 on pin 3 (COMMOOUT). This voltage can be used to set the common-mode of the output from the input driver.

[Figure 29](#), [Figure 30](#), [Figure 31](#), [Figure 32](#), and [Figure 33](#) show the recommended circuits to interface an analog input signal to the ADS8422.

PRINCIPLES OF OPERATION (continued)

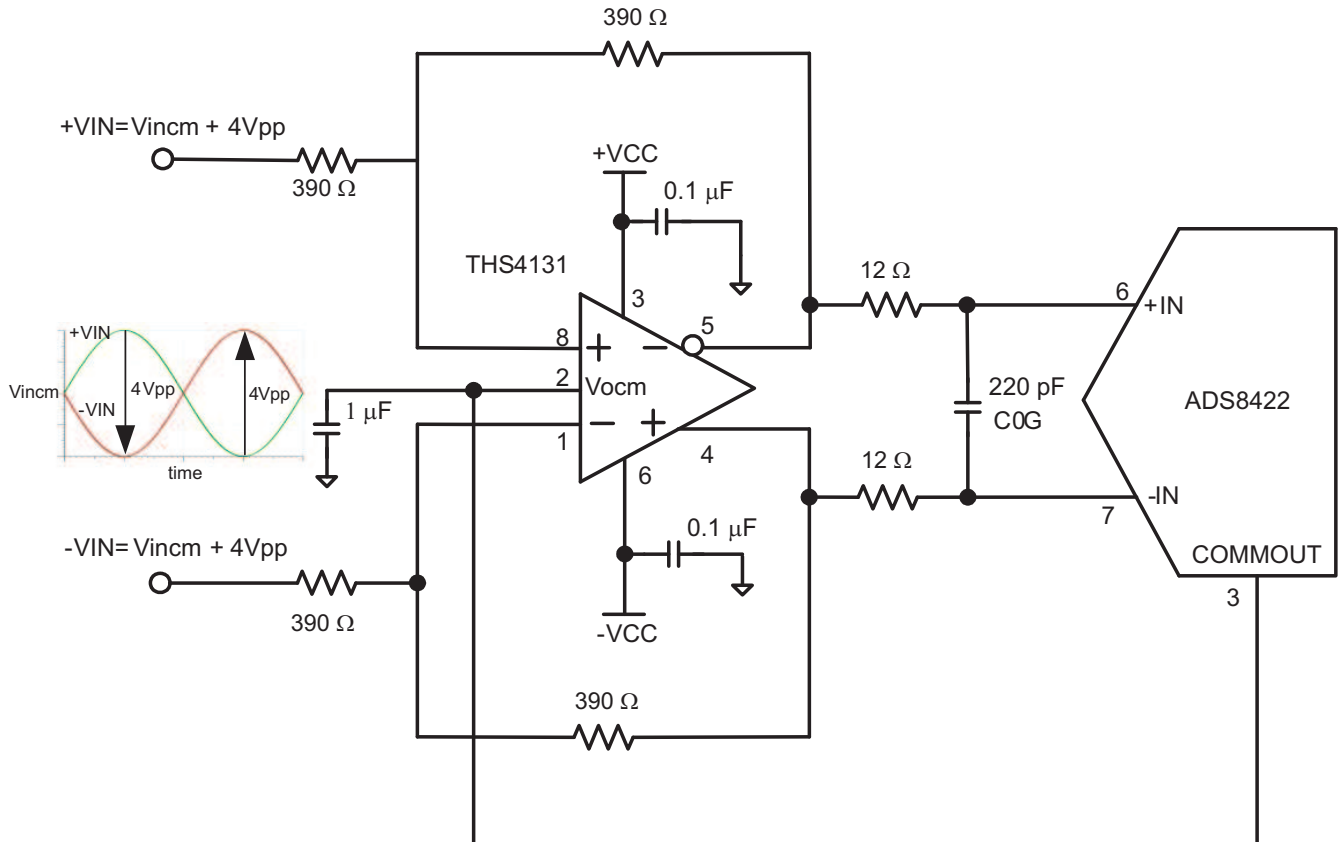

- A. Input common-mode voltage ($V_{in_{cm}}$) range is restricted by the amplifier. Refer to the amplifier data sheet for more information. Output common mode of the THS4131 is set by the voltage at pin 2. The COMMOUT pin of the ADS8422 is designed to source pin 2 of the THS4131. However to use this feature both the positive supply and negative supply rails must equal ($|-VCC| = |+VCC|$), absolutely.

Figure 29. Fully Differential Input Driver Circuit for Unipolar or Bipolar Signals

PRINCIPLES OF OPERATION (continued)

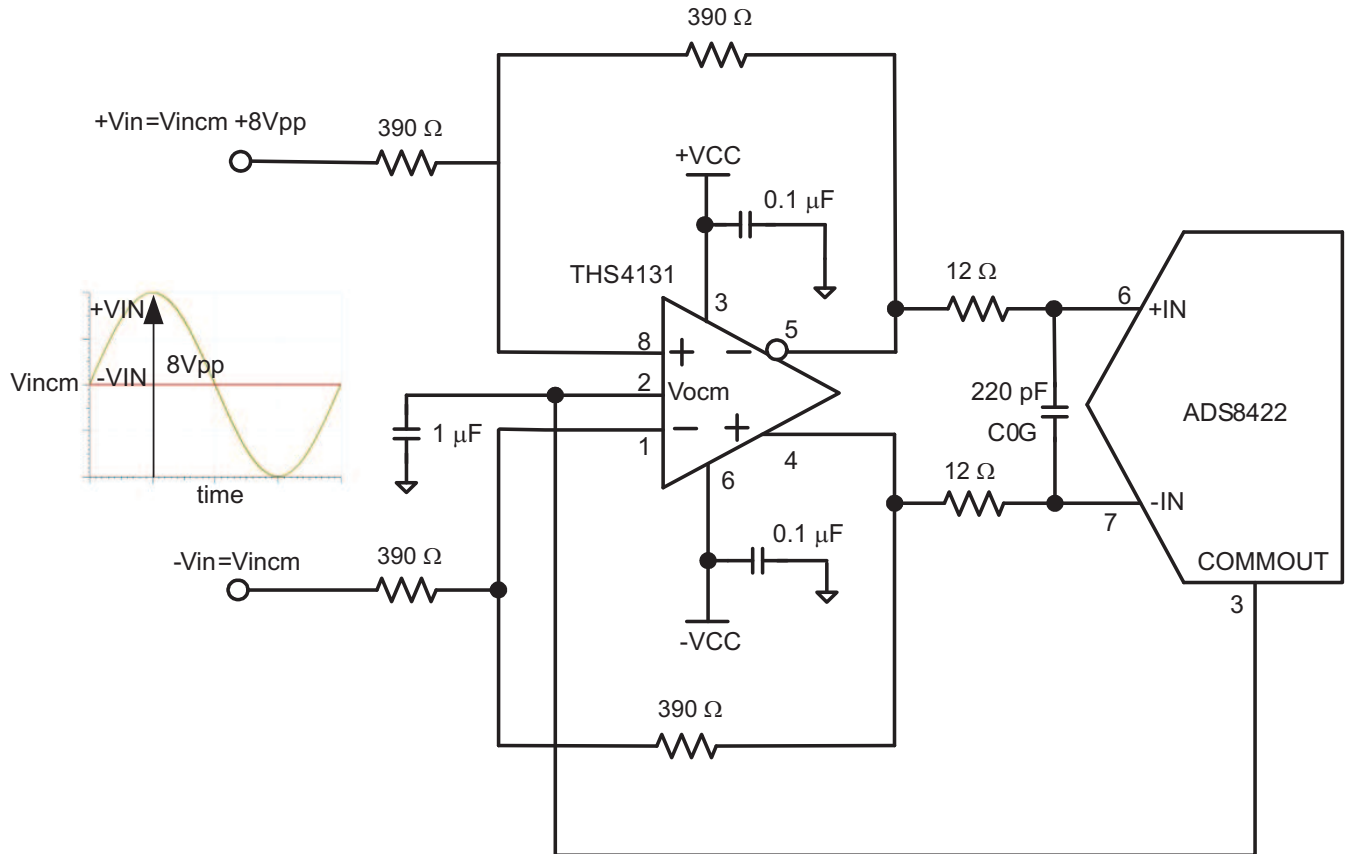

- A. Input common-mode voltage ($V_{in\text{cm}}$) range is restricted by the amplifier. Refer to the amplifier data sheet for more information. Output common mode of the THS4131 is set by the voltage at pin 2. The COMMOUT pin of the ADS8422 is designed to source pin 2 of the THS4131. However to use this feature both the positive supply and negative supply rails must equal ($|-VCC| = |+VCC|$), absolutely.

Figure 30. Single-Ended Input Driving Circuit for When Input is Unipolar or Bipolar

PRINCIPLES OF OPERATION (continued)

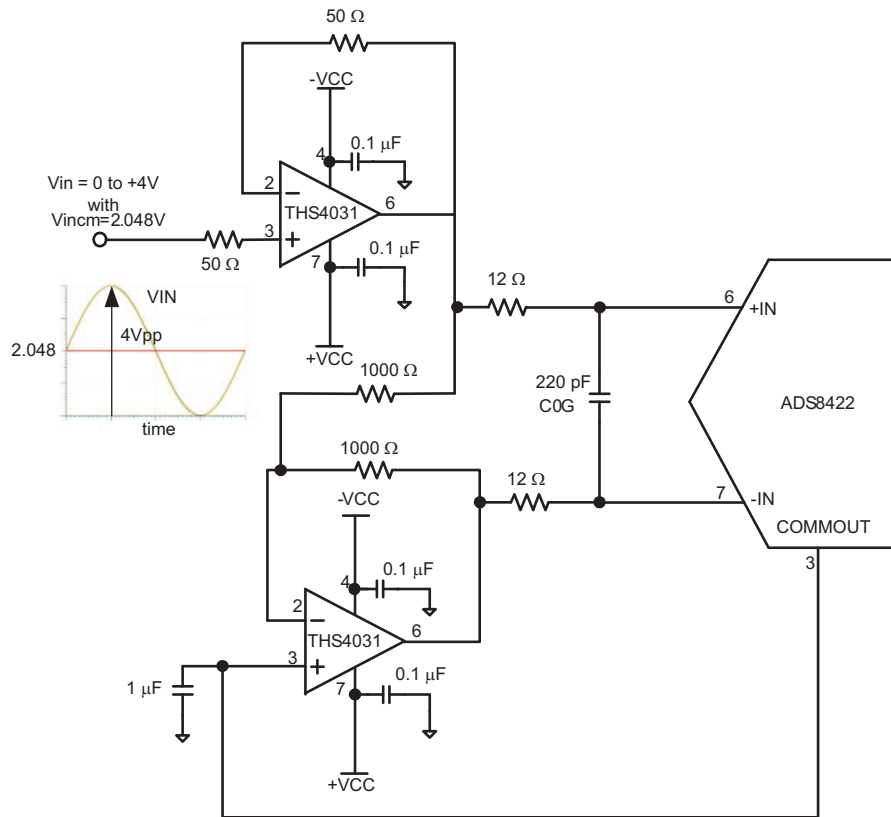
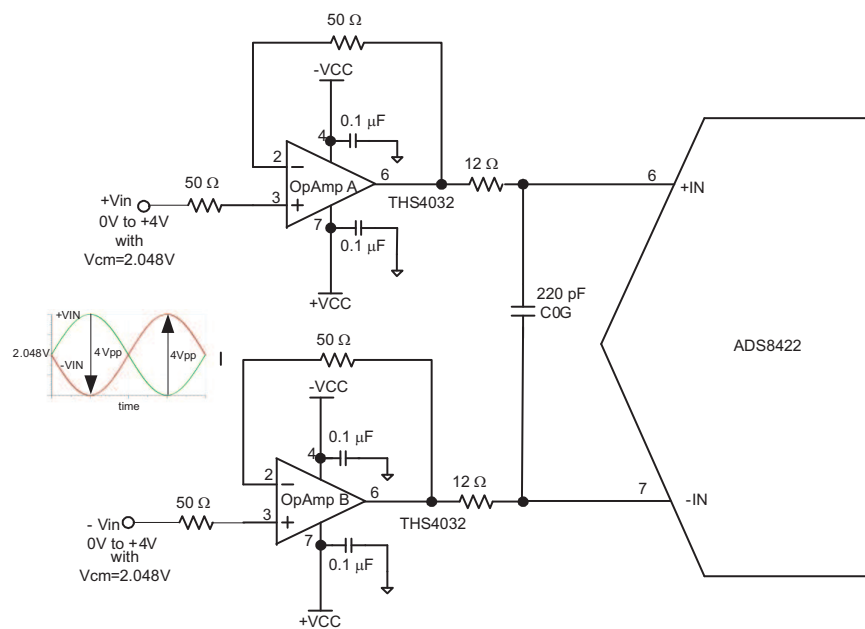

Figure 31. Single-Ended Driving Circuit for When Input is Single-Ended Unipolar and has Common-Mode of 2.048 V



A. This circuit is used to specify ADS8422 performance parameters listed in the data sheet.

Figure 32. Driver Circuit for When Input is Fully Differential Riding on Common-Mode of 2.048 V

PRINCIPLES OF OPERATION (continued)

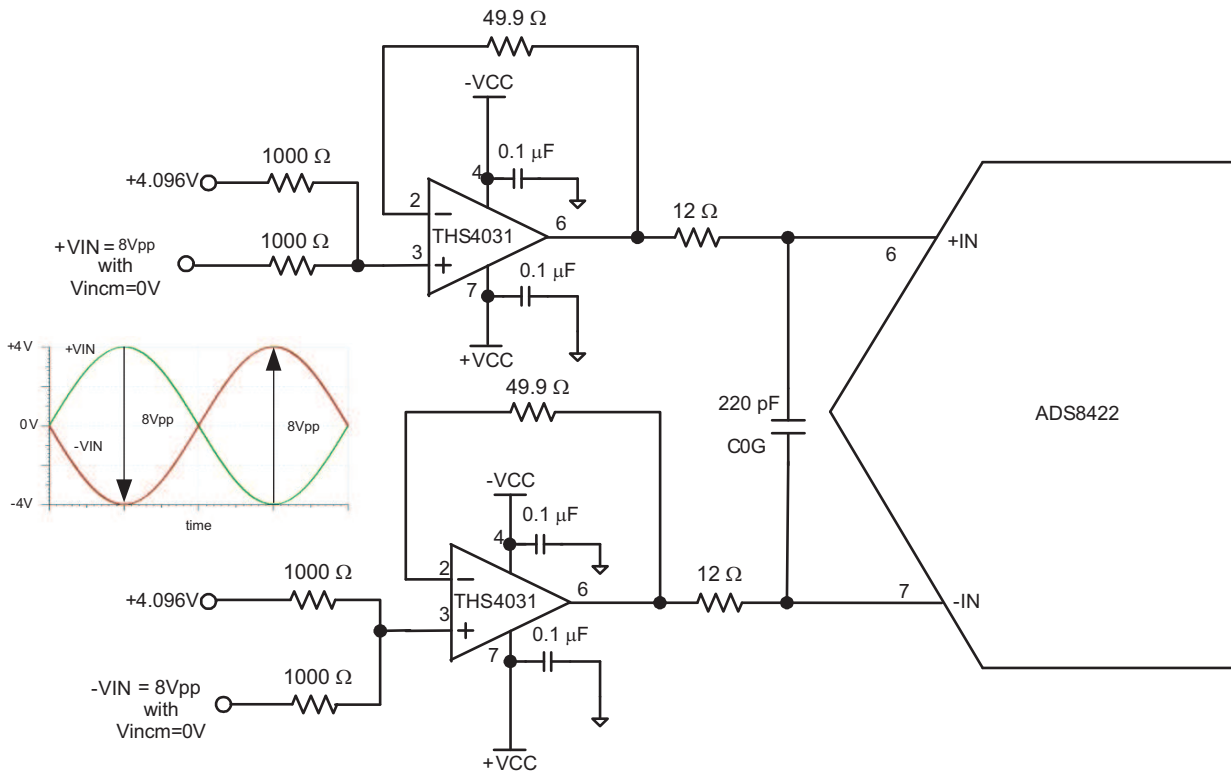

Figure 33. Driver Circuit for Bipolar Fully Differential Input Signals with 0-V Common-Mode

The input current on the analog inputs depends upon a number of factors: sample rate, input voltage, and source impedance. Essentially, the current into the ADS8422 charges the internal capacitor array during the sample period. After this capacitance has been fully charged, there is no further input current. The source of the analog input voltage must be able to charge the input capacitance (30 pF) to a 16-bit settling level within the 70 ns acquisition time of the device. When the converter goes into hold mode, the input impedance is greater than 1 GΩ.

Care must be taken regarding the absolute analog input voltage. To maintain the linearity of the converter, both -IN and +IN inputs should be within the limits specified. Outside of these ranges, the converter linearity may not meet specifications. To minimize noise, low bandwidth input signals with low pass filters should be used.

Care should be taken to ensure that the output impedances of the sources driving the +IN and -IN inputs are matched. If this is not observed, the two inputs could have different settling times. This may result in offset error, gain error, and linearity error which change with temperature and input voltage.

When the converter enters hold mode, the voltage difference between the +IN and -IN inputs is captured on the internal capacitor array.

DIGITAL INTERFACE

Timing and Control

See the timing diagrams for detailed information on timing signals and their requirements.

The ADS8422 uses an internal oscillator generated clock which controls the conversion rate and in turn the throughput of the converter. No external clock input is required.

PRINCIPLES OF OPERATION (continued)

Conversions are initiated by bringing the $\overline{\text{CONVST}}$ pin low for a minimum of 20 ns (after the 20 ns minimum requirement has been met, the $\overline{\text{CONVST}}$ pin can be brought high). The converter switches from sample to hold mode on the falling edge of the $\overline{\text{CONVST}}$ command. A clean and low jitter falling edge of this signal is important to the performance of the converter. The $\overline{\text{BUSY}}$ pin is brought high immediately following $\overline{\text{CONVST}}$ going low. $\overline{\text{BUSY}}$ stays high through the conversion process and returns low when the conversion has ended and data is available on the DB pins. Once the conversion is started, it cannot be stopped except with an asynchronous $\overline{\text{RESET}}$ (or a logical $\overline{\text{PD1}}$).

If $\overline{\text{CONVST}}$ is detected high at the end of conversion, the device immediately enters sampling mode and the analog input is connected to the CDAC. Otherwise, the CDAC is connected to the analog input only when $\overline{\text{CONVST}}$ goes high. The high duration of $\overline{\text{CONVST}}$ should be at least 100 ns. There is no maximum high pulse duration specification for $\overline{\text{CONVST}}$.

Reading Data

The ADS8422 outputs full parallel data in 2's complement format as shown in Table 1. The parallel output is active when $\overline{\text{CS}}$ and $\overline{\text{RD}}$ are both low. There is a minimal quiet zone requirement around the falling edge of $\overline{\text{CONVST}}$. This is 30 ns prior to the falling edge of $\overline{\text{CONVST}}$ and 10 ns after the falling edge. No data read should be attempted within this zone. Any other combination of $\overline{\text{CS}}$ and $\overline{\text{RD}}$ three-states the parallel output. $\overline{\text{BYTE}}$ is used for multi-word read operation. $\overline{\text{BYTE}}$ is used whenever lower bits on the bus are output on the higher byte of the bus. Refer to Table 1 for ideal output codes.

Table 1. Ideal Input Voltages and Output Codes

| DESCRIPTION | ANALOG VALUE | DIGITAL OUTPUT 2'S COMPLIMENT | |
|-----------------------------|-------------------------|-------------------------------|----------|
| | | BINARY CODE | HEX CODE |
| Full scale range | $2V_{\text{ref}}$ | | |
| Least significant bit (LSB) | $2V_{\text{ref}}/65536$ | | |
| +Full scale | $(+V_{\text{ref}}) -$ | 0111 1111 1111 1111 | 7FFF |
| Midscale | 0 V | 0000 0000 0000 0000 | 0000 |
| Midscale – 1 LSB | 0 V – | 1111 1111 1111 1111 | FFFF |
| -Full scale | $-V_{\text{ref}}+$ | 1000 0000 0000 0000 | 8000 |

The output data can be read as a full 16-bit word on pins DB15 – DB0 (MSB-LSB) if $\overline{\text{BYTE}}$ is low.

The result may also be read on an 8-bit bus for convenience. This is done by using only pins DB15-DB8. In this case two reads are necessary: the first as before, leaving $\overline{\text{BYTE}}$ low and reading the 8 most significant bits on pins DB15-DB8, then bringing $\overline{\text{BYTE}}$ high. When $\overline{\text{BYTE}}$ is high, the low bits (D7-D0) appear on pins DB15-DB8.

These multi-word read operations can be performed with a multiple active (toggling) $\overline{\text{RD}}$ signal or with the $\overline{\text{RD}}$ signal tied low for simplicity.

Table 2. Conversion Data Read Out

| BYTE | DATA READ OUT | |
|------|---------------|--------------|
| | PINS DB15–DB8 | PINS DB7–DB0 |
| High | D7 - D0 | All One's |
| Low | D15 - D8 | D7 - D0 |

RESET

$\overline{\text{RESET/PD1}}$ is an asynchronous active low input signal. Maximum $\overline{\text{RESET/PD1}}$ low time is 0.5 μs to avoid ADC powerdown. Current conversion is aborted no later than 20 ns after the converter is in reset mode. The converter returns to normal operation mode no later than 20 ns after the $\overline{\text{RESET/PD1}}$ input is brought high (see Figure 28).

The converter provides two power saving options: ADC powerdown (using pin 38, $\overline{\text{PD1}}$) and analog output powerdown ($\overline{\text{PD2}}$).

ADC powerdown is activated by asserting $\overline{\text{PD1}}$ to 0 for longer than 1.5 μs . If the signal $\overline{\text{PD1}}$ is asserted 0 for less than 0.5 μs , the ADC is only reset and any ongoing conversion aborted. See Figure 26. ADC operation can be resumed from ADC powerdown by de-asserting the $\overline{\text{PD1}}$ pin. In ADC power-down mode, the analog outputs from the ADC (COMMOUT, REFOUT) are not powered down thereby reducing the power-on time.

Full chip power-down is activated by turning off the power supply or by asserting both, $\overline{\text{PD1}} = 0$ and $\overline{\text{PD2}} = 0$ for longer than 1.5 μs (see Figure 27). In this mode, even the analog outputs of the ADC (COMMOUT, REFOUT) are powered down thereby giving maximum power saving. Device operation can be resumed from full chip power-down by turning on the power supply or by deasserting both, $\overline{\text{PD1}} = 1$ and $\overline{\text{PD2}} = 1$.

Table 3. Effects of $\overline{\text{RESET}}$, $\overline{\text{PD1}}$, and $\overline{\text{PD2}}$

| COMMAND | APPLICATION TIME | POWER WHEN APPLIED | RESUME TIME |
|--|--|--------------------|-----------------|
| $\overline{\text{RESET}}/\overline{\text{PD1}} = 0$ | 20 ns | No change | 20 ns |
| $\overline{\text{PD1}} = 0, \overline{\text{PD2}} = 1$ | 1.5 μs | 17mW | 5 μs |
| $\overline{\text{PD1}} = \overline{\text{PD2}} = 0$ | 1.5 μs | 40 μW | 25 ms |
| $\overline{\text{PD1}} = 1, \overline{\text{PD2}} = 0$ | Reserved – Do not use this combination | | |

LAYOUT

For optimum performance, care should be taken with the physical layout of the ADS8422 circuitry.

As the ADS8422 offers single-supply operation, it is often used in close proximity with digital logic, microcontrollers, microprocessors, and digital signal processors. The more digital logic present in the design and the higher the switching speed, the more difficult it is to achieve good performance from the converter.

The basic SAR architecture is sensitive to glitches or sudden changes on the power supply, reference, ground connections, and digital inputs that occur just prior to latching the output of the analog comparator. Thus, driving any single conversion for an n-clock SAR converter, there are n *windows* in which large external transient voltages can affect the conversion result. Such glitches might originate from switching power supplies, nearby digital logic, or high power devices. The 50 ns period before BUSY falls should be kept free of supply glitches.

The degree of error in the digital output depends on the reference voltage, layout, and the exact timing of the external event.

On average, the ADS8422 draws very little current from an external reference as the reference voltage is internally buffered. If the reference voltage is external and originates from an op amp, make sure that it can drive the bypass capacitor or capacitors without oscillation. A 0.1- μF bypass capacitor is recommended from pin 1 directly to REFM (pin 48). REFM and AGND should be shorted on the same ground plane underneath the device.

The AGND, BDGND, and AGND pins should be connected to a clean ground point. In all cases, this should be the *analog* ground. Avoid connections which are too close to the grounding point of a microcontroller or digital signal processor. If required, run a ground trace directly from the converter to the power supply entry point. The ideal layout consists of an analog ground plane dedicated to the converter and associated analog circuitry.

As with the AGND connections, +VA and +VAREG should be connected to their respective power supply planes or traces that are separate from the connection for digital logic, until they are connected at the power entry point. Power to the ADS8422 should be clean and well bypassed. A 0.1- μF ceramic bypass capacitor should be placed as close to the device as possible. See Table 4 for capacitor placement. In addition, a 1- μF to 10- μF capacitor is recommended. In some situations, additional bypassing may be required, such as a 100- μF electrolytic capacitor or even a *Pi* filter made up of inductors and capacitors — all designed to essentially low-pass filter the +5-V supply, thus removing the high frequency noise.

Table 4. Power Supply Decoupling Capacitor Placement

| POWER SUPPLY PLANE | CONVERTER ANALOG SIDE | CONVERTER DIGITAL SIDE |
|---|--|------------------------|
| SUPPLY PINS | | |
| Pin pairs that require shortest path to decoupling capacitors | (4,5), (9,8), (10,12), (13,15), (43,44), (46,45) | (24,25), (34,35) |

PACKAGING INFORMATION

| Orderable part number | Status (1) | Material type (2) | Package Pins | Package qty Carrier | RoHS (3) | Lead finish/ Ball material (4) | MSL rating/ Peak reflow (5) | Op temp (°C) | Part marking (6) |
|-------------------------------|---------------|----------------------|-----------------|-----------------------|-------------|--------------------------------------|-----------------------------------|--------------|---------------------|
| ADS8422IBPFBR | Active | Production | TQFP (PFB) 48 | 1000 LARGE T&R | Yes | NIPDAU | Level-2-260C-1 YEAR | -40 to 85 | ADS 8422I B |
| ADS8422IBPFBR.A | Active | Production | TQFP (PFB) 48 | 1000 LARGE T&R | Yes | NIPDAU | Level-2-260C-1 YEAR | -40 to 85 | ADS 8422I B |
| ADS8422IBPFBT | Active | Production | TQFP (PFB) 48 | 250 SMALL T&R | Yes | Call TI | Level-2-260C-1 YEAR | -40 to 85 | ADS 8422I B |
| ADS8422IBPFBT.A | Active | Production | TQFP (PFB) 48 | 250 SMALL T&R | Yes | Call TI | Level-2-260C-1 YEAR | -40 to 85 | ADS 8422I B |
| ADS8422IPFBR | Active | Production | TQFP (PFB) 48 | 1000 LARGE T&R | Yes | NIPDAU | Level-2-260C-1 YEAR | -40 to 85 | ADS 8422I |
| ADS8422IPFBR.A | Active | Production | TQFP (PFB) 48 | 1000 LARGE T&R | Yes | NIPDAU | Level-2-260C-1 YEAR | -40 to 85 | ADS 8422I |

(1) **Status:** For more details on status, see our [product life cycle](#).

(2) **Material type:** When designated, preproduction parts are prototypes/experimental devices, and are not yet approved or released for full production. Testing and final process, including without limitation quality assurance, reliability performance testing, and/or process qualification, may not yet be complete, and this item is subject to further changes or possible discontinuation. If available for ordering, purchases will be subject to an additional waiver at checkout, and are intended for early internal evaluation purposes only. These items are sold without warranties of any kind.

(3) **RoHS values:** Yes, No, RoHS Exempt. See the [TI RoHS Statement](#) for additional information and value definition.

(4) **Lead finish/Ball material:** Parts may have multiple material finish options. Finish options are separated by a vertical ruled line. Lead finish/Ball material values may wrap to two lines if the finish value exceeds the maximum column width.

(5) **MSL rating/Peak reflow:** The moisture sensitivity level ratings and peak solder (reflow) temperatures. In the event that a part has multiple moisture sensitivity ratings, only the lowest level per JEDEC standards is shown. Refer to the shipping label for the actual reflow temperature that will be used to mount the part to the printed circuit board.

(6) **Part marking:** There may be an additional marking, which relates to the logo, the lot trace code information, or the environmental category of the part.

Multiple part markings will be inside parentheses. Only one part marking contained in parentheses and separated by a "~" will appear on a part. If a line is indented then it is a continuation of the previous line and the two combined represent the entire part marking for that device.

Important Information and Disclaimer: The information provided on this page represents TI's knowledge and belief as of the date that it is provided. TI bases its knowledge and belief on information provided by third parties, and makes no representation or warranty as to the accuracy of such information. Efforts are underway to better integrate information from third parties. TI has taken and continues to take reasonable steps to provide representative and accurate information but may not have conducted destructive testing or chemical analysis on incoming materials and chemicals. TI and TI suppliers consider certain information to be proprietary, and thus CAS numbers and other limited information may not be available for release.

In no event shall TI's liability arising out of such information exceed the total purchase price of the TI part(s) at issue in this document sold by TI to Customer on an annual basis.

TAPE AND REEL INFORMATION

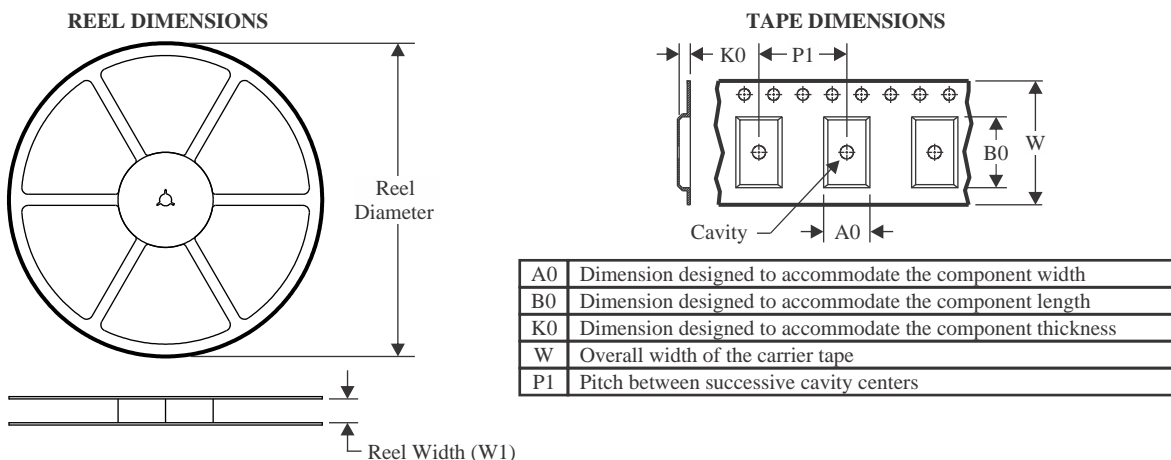

QUADRANT ASSIGNMENTS FOR PIN 1 ORIENTATION IN TAPE

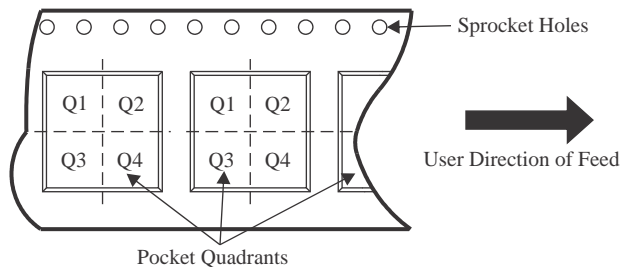

*All dimensions are nominal

| Device | Package Type | Package Drawing | Pins | SPQ | Reel Diameter (mm) | Reel Width W1 (mm) | A0 (mm) | B0 (mm) | K0 (mm) | P1 (mm) | W (mm) | Pin1 Quadrant |
|---------------|--------------|-----------------|------|------|--------------------|--------------------|---------|---------|---------|---------|--------|---------------|
| ADS8422IBPFBR | TQFP | PFB | 48 | 1000 | 330.0 | 16.4 | 9.6 | 9.6 | 1.5 | 12.0 | 16.0 | Q2 |
| ADS8422IPFBR | TQFP | PFB | 48 | 1000 | 330.0 | 16.4 | 9.6 | 9.6 | 1.5 | 12.0 | 16.0 | Q2 |

TAPE AND REEL BOX DIMENSIONS



*All dimensions are nominal

| Device | Package Type | Package Drawing | Pins | SPQ | Length (mm) | Width (mm) | Height (mm) |
|---------------|--------------|-----------------|------|------|-------------|------------|-------------|
| ADS8422IBPFBR | TQFP | PFB | 48 | 1000 | 350.0 | 350.0 | 43.0 |
| ADS8422IPFBR | TQFP | PFB | 48 | 1000 | 350.0 | 350.0 | 43.0 |

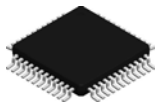

PFB0048A

PACKAGE OUTLINE

TQFP - 1.2 mm max height

PLASTIC QUAD FLATPACK

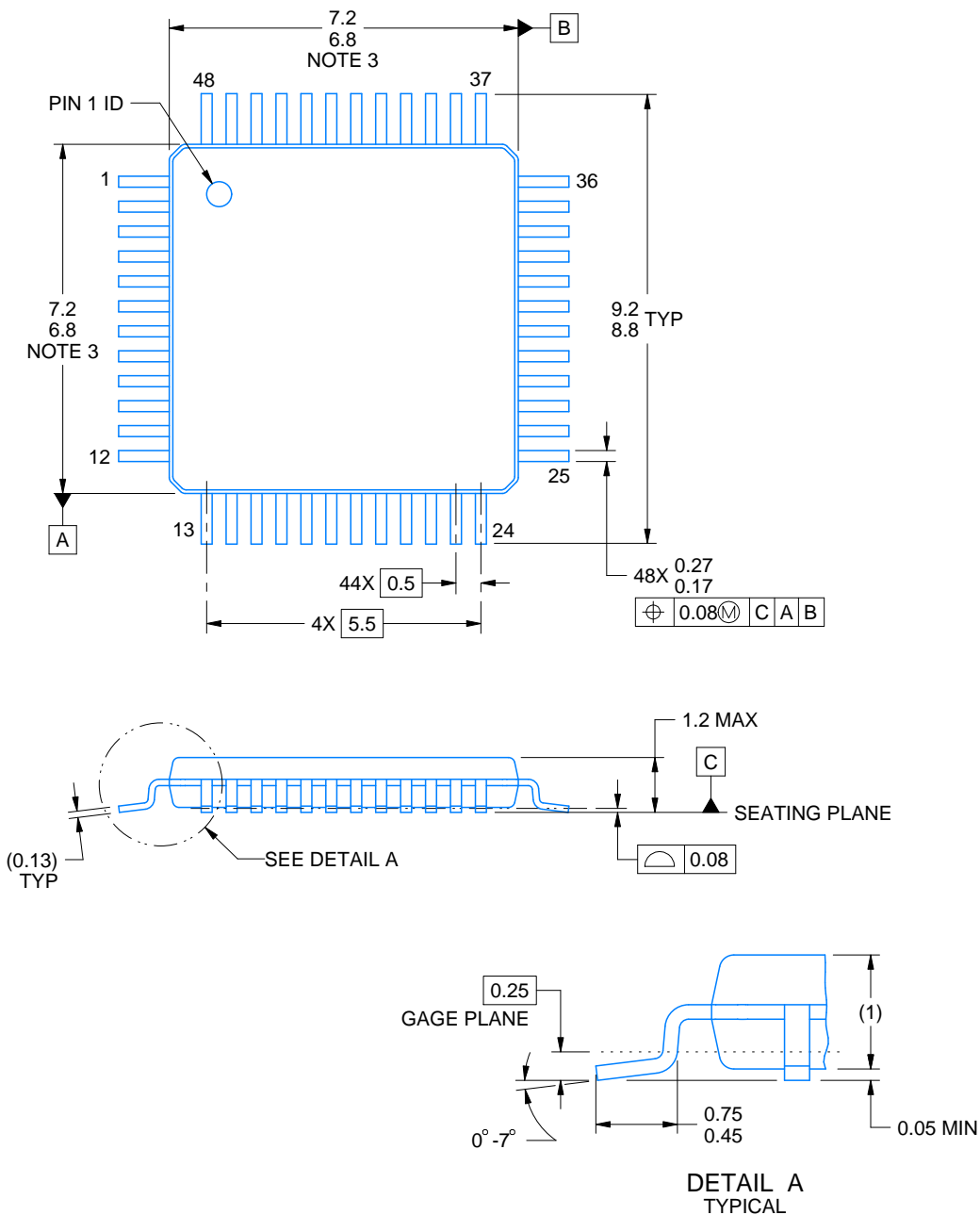

4215157/A 03/2024

NOTES:

1. All linear dimensions are in millimeters. Any dimensions in parenthesis are for reference only. Dimensioning and tolerancing per ASME Y14.5M.
2. This drawing is subject to change without notice.
3. Reference JEDEC registration MS-026.

EXAMPLE BOARD LAYOUT

PFB0048A

TQFP - 1.2 mm max height

PLASTIC QUAD FLATPACK

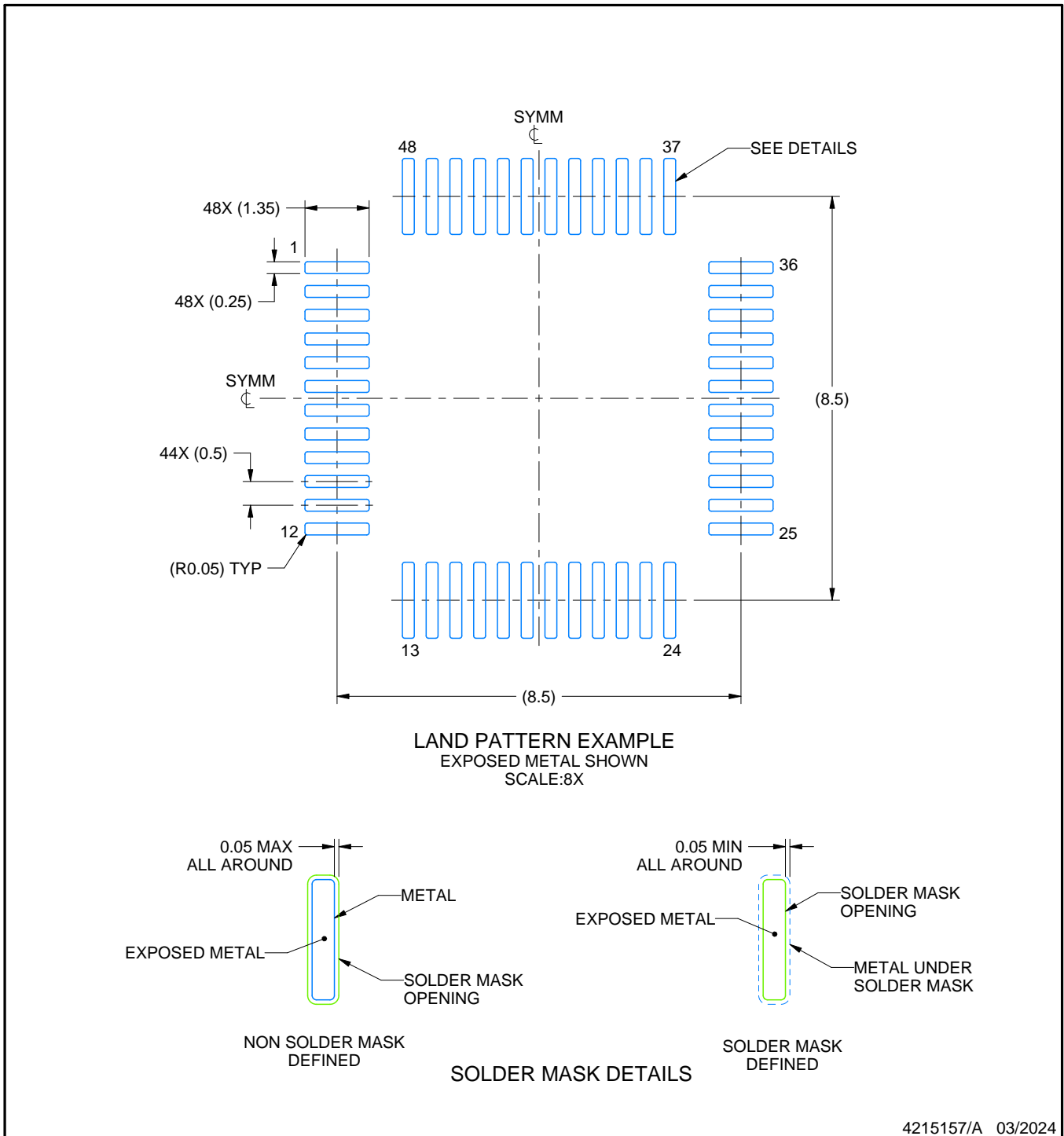

4215157/A 03/2024

NOTES: (continued)

- 4. Publication IPC-7351 may have alternate designs.
- 5. Solder mask tolerances between and around signal pads can vary based on board fabrication site.

EXAMPLE STENCIL DESIGN

PFB0048A

TQFP - 1.2 mm max height

PLASTIC QUAD FLATPACK

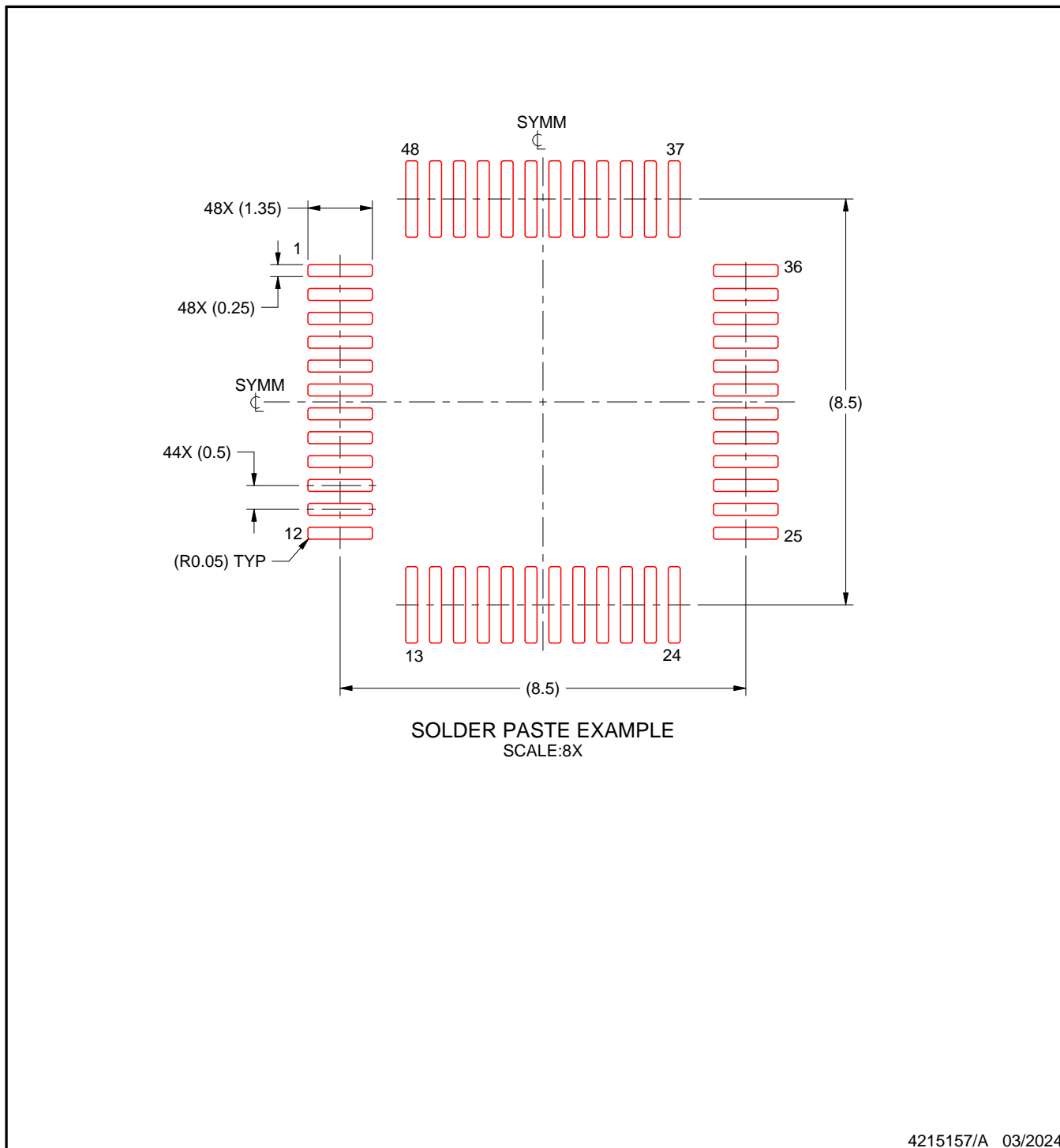

NOTES: (continued)

6. Laser cutting apertures with trapezoidal walls and rounded corners may offer better paste release. IPC-7525 may have alternate design recommendations.
7. Board assembly site may have different recommendations for stencil design.

IMPORTANT NOTICE AND DISCLAIMER

TI PROVIDES TECHNICAL AND RELIABILITY DATA (INCLUDING DATASHEETS), DESIGN RESOURCES (INCLUDING REFERENCE DESIGNS), APPLICATION OR OTHER DESIGN ADVICE, WEB TOOLS, SAFETY INFORMATION, AND OTHER RESOURCES "AS IS" AND WITH ALL FAULTS, AND DISCLAIMS ALL WARRANTIES, EXPRESS AND IMPLIED, INCLUDING WITHOUT LIMITATION ANY IMPLIED WARRANTIES OF MERCHANTABILITY, FITNESS FOR A PARTICULAR PURPOSE OR NON-INFRINGEMENT OF THIRD PARTY INTELLECTUAL PROPERTY RIGHTS.

These resources are intended for skilled developers designing with TI products. You are solely responsible for (1) selecting the appropriate TI products for your application, (2) designing, validating and testing your application, and (3) ensuring your application meets applicable standards, and any other safety, security, regulatory or other requirements.

These resources are subject to change without notice. TI grants you permission to use these resources only for development of an application that uses the TI products described in the resource. Other reproduction and display of these resources is prohibited. No license is granted to any other TI intellectual property right or to any third party intellectual property right. TI disclaims responsibility for, and you fully indemnify TI and its representatives against any claims, damages, costs, losses, and liabilities arising out of your use of these resources.

TI's products are provided subject to [TI's Terms of Sale](#), [TI's General Quality Guidelines](#), or other applicable terms available either on ti.com or provided in conjunction with such TI products. TI's provision of these resources does not expand or otherwise alter TI's applicable warranties or warranty disclaimers for TI products. Unless TI explicitly designates a product as custom or customer-specified, TI products are standard, catalog, general purpose devices.

TI objects to and rejects any additional or different terms you may propose.

Copyright © 2025, Texas Instruments Incorporated

Last updated 10/2025

OUR CERTIFICATE

DiGi provide top-quality products and perfect service for customer worldwide through standardization, technological innovation and continuous improvement. DiGi through third-party certification, we strictly control the quality of products and services. Welcome your RFQ to

Email: Info@DiGi-Electronics.com



Tel: +00 852-30501935

RFQ Email: Info@DiGi-Electronics.com

DiGi is a global authorized distributor of electronic components.