

# DAC8551AQDGKRQ1 Datasheet

[www.digi-electronics.com](http://www.digi-electronics.com)



DAC8551AQDGKRQ1

<https://www.DiGi-Electronics.com>

DiGi Electronics Part Number	DAC8551AQDGKRQ1-DG
Manufacturer	<a href="#">Texas Instruments</a>
Manufacturer Product Number	DAC8551AQDGKRQ1
Description	IC DAC 16BIT V-OUT 8VSSOP
Detailed Description	16 Bit Digital to Analog Converter 1 8-VSSOP



Tel: +00 852-30501935

RFQ Email: [Info@DiGi-Electronics.com](mailto:Info@DiGi-Electronics.com)

DiGi is a global authorized distributor of electronic components.

## Purchase and inquiry

Manufacturer Product Number:

DAC8551AQDGKRQ1

Series:

microPOWER™

DiGi-Electronics Programmable:

Not Verified

Number of D/A Converters:

1

Output Type:

Voltage - Buffered

Data Interface:

SPI, DSP

Voltage - Supply, Analog:

3.2V ~ 5.5V

INL/DNL (LSB):

±4, ±0.35

Operating Temperature:

-40°C ~ 125°C

Supplier Device Package:

8-VSSOP

Grade:

Automotive

Base Product Number:

DAC8551

Manufacturer:

Texas Instruments

Product Status:

Active

Number of Bits:

16

Settling Time:

8µs (Typ)

Differential Output:

No

Reference Type:

External

Voltage - Supply, Digital:

3.2V ~ 5.5V

Architecture:

String DAC

Package / Case:

8-TSSOP, 8-MSOP (0.118", 3.00mm Width)

Mounting Type:

Surface Mount

Qualification:

AEC-Q100

## Environmental & Export classification

RoHS Status:

ROHS3 Compliant

REACH Status:

REACH Unaffected

HTSUS:

8542.39.0001

Moisture Sensitivity Level (MSL):

2 (1 Year)

ECCN:

EAR99

DAC8551-Q1  
Product FolderAODGKRO1  
Sample & BuyTexas Instruments  
Technical DocumentsIC DAC 16BIT V-OUT 8VSSQP  
Tools & Software

Support &amp; Community



Reference Design



DAC8551-Q1, DAC6551-Q1

SLASEB8C –FEBRUARY 2016–REVISED NOVEMBER 2016

# DACx551-Q1 Automotive 16-, 12-Bit, Ultralow-Glitch, Voltage-Output DAC

## 1 Features

- Qualified for Automotive Applications
- AEC-Q100 Qualified With the Following Results:
  - Device Temperature Grade 1:  $-40^{\circ}\text{C}$  to  $125^{\circ}\text{C}$  Ambient Operating Temperature Range
  - Device HBM ESD Classification Level 2
  - Device CDM ESD Classification Level C4B
- Relative Accuracy:
  - DAC8551-Q1 (16-Bit): 4 LSB INL
  - DAC6551-Q1 (12-Bit): 0.3 LSB INL
- Ultralow Glitch Impulse: 0.1 nV-s
- Settling Time: 8  $\mu\text{s}$  to  $\pm 0.003\%$  FSR
- Power Supply: 3 V to 5.5 V
- Power-On Reset to Zero Scale
- *MicroPower* Operation: 160  $\mu\text{A}$  at 5 V
- Low-Power Serial Interface With Schmitt-Triggered Inputs
- On-Chip Output Buffer Amplifier With Rail-to-Rail Operation
- Power-Down Capability
- Binary Input
- SYNC Interrupt Facility
- Available in a Tiny VSSOP-8 Package

## 2 Applications

- Automotive Radar
- Automotive Sensors

## 3 Description

The DAC8551-Q1 and DAC6551-Q1 are small, low-power, voltage-output, 16- and 12-bit digital-to-analog converters (DACs) qualified for automotive applications. The DACx551-Q1 devices provide good linearity and minimize undesired code-to-code transient voltages. The devices use a versatile 3-wire serial interface that operates at clock rates to 30 MHz and is compatible with standard SPI, QSPI, Microwire, and digital signal-processor (DSP) interfaces.

The DACx551-Q1 devices require an external reference voltage to set the output range. The devices incorporate a power-on-reset circuit that ensures the DAC output powers up at 0 V and remains there until a valid write to the device takes place. The devices contain a power-down feature, accessed over the serial interface, that reduces the current consumption to 800 nA at 5 V.

The DACx551-Q1 devices power consumption is only 800  $\mu\text{W}$  at 5 V, reducing to less than 4  $\mu\text{W}$  in power-down mode. The DACx551-Q1 devices are available in a VSSOP-8 package.

### Device Information<sup>(1)</sup>

PART NUMBER	PACKAGE	BODY SIZE (NOM)
DAC8551-Q1	VSSOP (8)	3.00 mm x 3.00 mm
DAC6551-Q1		

(1) For all available packages, see the orderable addendum at the end of the data sheet.

### Functional Block Diagram

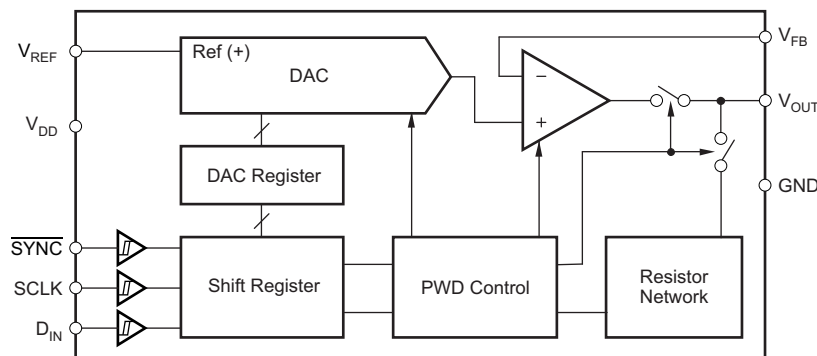

Copyright © 2016, Texas Instruments Incorporated



An IMPORTANT NOTICE at the end of this data sheet addresses availability, warranty, changes, use in safety-critical applications, intellectual property matters and other important disclaimers. PRODUCTION DATA.

**DAC8551-Q1, DAC6551-Q1**

SLASEB8C – FEBRUARY 2016 – REVISED NOVEMBER 2016

www.ti.com

**Table of Contents**

<b>1 Features</b> .....	1	7.4 Device Functional Modes .....	15
<b>2 Applications</b> .....	1	7.5 Programming .....	16
<b>3 Description</b> .....	1	<b>8 Application and Implementation</b> .....	17
<b>4 Revision History</b> .....	2	8.1 Application Information .....	17
<b>5 Pin Configuration and Functions</b> .....	4	8.2 Typical Applications .....	17
<b>6 Specifications</b> .....	4	8.3 System Examples .....	20
6.1 Absolute Maximum Ratings .....	4	<b>9 Power Supply Recommendations</b> .....	21
6.2 ESD Ratings .....	5	<b>10 Layout</b> .....	21
6.3 Recommended Operating Conditions .....	5	10.1 Layout Guidelines .....	21
6.4 Thermal Information .....	5	10.2 Layout Example .....	21
6.5 Electrical Characteristics .....	5	<b>11 Device and Documentation Support</b> .....	22
6.6 Timing Requirements .....	7	11.1 Documentation Support .....	22
6.7 Switching Characteristics .....	7	11.2 Receiving Notification of Documentation Updates .....	22
6.8 Typical Characteristics .....	8	11.3 Community Resources .....	22
<b>7 Detailed Description</b> .....	13	11.4 Trademarks .....	22
7.1 Overview .....	13	11.5 Electrostatic Discharge Caution .....	22
7.2 Functional Block Diagram .....	13	11.6 Glossary .....	22
7.3 Feature Description .....	13	<b>12 Mechanical, Packaging, and Orderable Information</b> .....	22

**4 Revision History**

<b>Changes from Revision B (November 2016) to Revision C</b>	<b>Page</b>
• Added device DAC6551-Q1 to the data sheet .....	1
• Changed the data sheet Title From: DAC8551-Q1 Automotive 16-Bit... To: DACx551-Q1 Automotive 16-, 12-Bit... .....	1
• Changed Relative Accuracy in the <i>Features</i> section .....	1
• Updated the <i>Description</i> to include the DAC6551-Q1 device .....	1
• Added DAC6551-Q1 to the <i>Thermal Table</i> .....	5
• Added separate lines for the DAC6551-Q1 and DAC8551-Q1 devices for Resolution, Relative accuracy, and Differential nonlinearity in the <i>Electrical Characteristics</i> table .....	5
• Changed Note 1 of the <i>Electrical Characteristics</i> table .....	6
• Updated the <i>Overview</i> section to include the DAC6551-Q1 device .....	13
• Changed <a href="#">Equation 1</a> .....	13
• Changed the definitions of in the "where:" statement for <a href="#">Equation 1</a> .....	14
• Deleted a sentence from the <i>Resistor String</i> section: "Monotonicity is ensured because of the string resistor architecture." .....	14
• Added <a href="#">Figure 31</a> .....	16
• Updated the <i>Application Information</i> section to include the DAC6551-Q1 device .....	17
• Updated the <i>Using the REF02 As a Power Supply for the DACx551-Q1 Device</i> section to include the DAC6551-Q1 device .....	19
• Updated the <i>System Examples</i> section to include the DAC6551-Q1 device .....	20
• Updated the <i>Power Supply Recommendations</i> section to include the DAC6551-Q1 device .....	21
• Updated the <i>Layout Guidelines</i> section to include the DAC6551-Q1 device .....	21

<b>Changes from Revision A (March 2016) to Revision B</b>	<b>Page</b>
• Changed Relative Accuracy in the <i>Features</i> section .....	1
• Changed power supply voltage in the <i>Features</i> section .....	1
• Changed voltage for $V_{DD}$ in the <i>Pin Functions</i> table .....	4
• Changed supply voltage in the <i>Recommended Operating Conditions</i> table .....	5
• Changed values in the <i>Thermal Information</i> table.....	5
• Changed supply voltage in the conditions statement of the <i>Electrical Characteristics</i> table .....	5
• Removed two rows and all test conditions in the <i>LOGIC INPUTS</i> section of the <i>Electrical Characteristics</i> table.....	6
• Changed supply voltage in the <i>POWER REQUIREMENTS</i> section of the <i>Electrical Characteristics</i> table .....	6
• Changed test conditions for supply current in the <i>POWER REQUIREMENTS</i> section of the <i>Electrical Characteristics</i> table .....	6
• Changed $V_{DD}$ in the condition statement and test conditions of the <i>Timing Requirements</i> <sup>(1)(2)</sup> section .....	7
• Changed MIN value for SCLK low time in the <i>Timing Requirements</i> <sup>(1)(2)</sup> section .....	7
• Added text in the <i>Application Information</i> section .....	17
• Changed supply voltage in the <i>Power Supply Recommendations</i> section .....	21
• Added new <i>Receiving Notification of Documentation Updates</i> section.....	22
<hr/>	
<b>Changes from Original (February 2016) to Revision A</b>	<b>Page</b>
• Changed data sheet from PRODUCT PREVIEW to PRODUCTON DATA .....	1

**DAC8551-Q1, DAC6551-Q1**

SLASEB8C – FEBRUARY 2016 – REVISED NOVEMBER 2016

www.ti.com

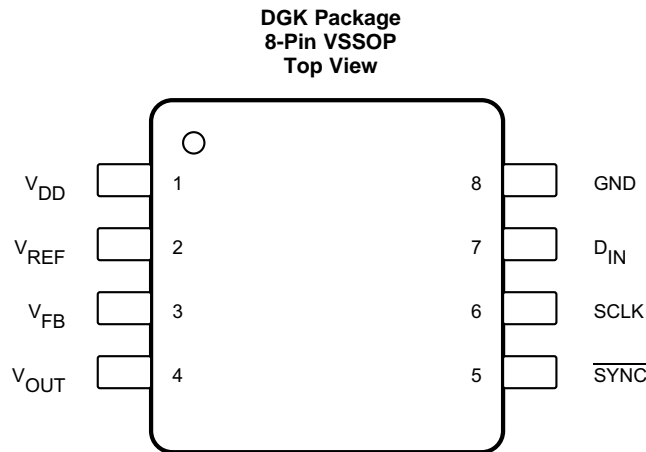
**5 Pin Configuration and Functions****Pin Functions**

PIN		TYPE	DESCRIPTION
NAME	NO.		
D <sub>IN</sub>	7	I	Serial data input. Data is clocked into the 24-bit input shift register on each falling edge of the serial clock input. Schmitt-trigger logic input.
GND	8	GND	Ground reference point for all circuitry on the device
SCLK	6	I	Serial clock input. Data can be transferred at rates up to 30 MHz. Schmitt-trigger logic input.
$\overline{\text{SYNC}}$	5	I	Level-triggered control input (active-low). This is the frame synchronization signal for the input data. $\overline{\text{SYNC}}$ going low enables the input shift register, and data is transferred in on the falling edges of the following clocks. The DAC is updated following the 24th clock (unless $\overline{\text{SYNC}}$ is taken high before this edge, in which case the rising edge of $\overline{\text{SYNC}}$ acts as an interrupt, and the write sequence is ignored by the device). Schmitt-trigger logic input.
V <sub>DD</sub>	1	PWR	Power supply input, 3 V to 5.5 V
V <sub>FB</sub>	3	I	Feedback connection for the output amplifier. For voltage output operation, tie to V <sub>OUT</sub> externally.
V <sub>OUT</sub>	4	O	Analog output voltage from DAC. The output amplifier has rail-to-rail operation.
V <sub>REF</sub>	2	I	Reference voltage input

**6 Specifications****6.1 Absolute Maximum Ratings**over operating ambient temperature range (unless otherwise noted)<sup>(1)</sup>

	MIN	MAX	UNIT
V <sub>DD</sub> to GND	-0.3	6	V
Digital input voltage to GND D <sub>IN</sub> , SCLK and $\overline{\text{SYNC}}$	-0.3	V <sub>DD</sub> + 0.3	V
V <sub>OUT</sub> to GND	-0.3	V <sub>DD</sub> + 0.3	V
V <sub>REF</sub> to GND	-0.3	V <sub>DD</sub> + 0.3	V
V <sub>FB</sub> to GND	-0.3	V <sub>DD</sub> + 0.3	V
Junction temperature range, T <sub>J</sub> max	-65	150	°C
Storage temperature, T <sub>stg</sub>	-65	150	°C

(1) Stresses beyond those listed under *Absolute Maximum Ratings* may cause permanent damage to the device. These are stress ratings only, which do not imply functional operation of the device at these or any other conditions beyond those indicated under *Recommended Operating Conditions*. Exposure to absolute-maximum-rated conditions for extended periods may affect device reliability.

## 6.2 ESD Ratings

		VALUE	UNIT	
V <sub>(ESD)</sub>	Electrostatic discharge	Human-body model (HBM), per AEC Q100-002 <sup>(1)</sup>	±2000	
		Charged-device model (CDM), per AEC Q100-011	All pins	±500
			Corner pins (1, 4, 5, and 8)	±750

(1) AEC Q100-002 indicates that HBM stressing shall be in accordance with the ANSI/ESDA/JEDEC JS-001 specification.

## 6.3 Recommended Operating Conditions

over operating ambient temperature range (unless otherwise noted)

		MIN	NOM	MAX	UNIT
<b>POWER SUPPLY</b>					
Supply voltage	V <sub>DD</sub> to GND	3		5.5	V
<b>DIGITAL INPUTS</b>					
Digital input voltage	D <sub>IN</sub> , SCLK and SYNC	0		V <sub>DD</sub>	V
<b>REFERENCE INPUT</b>					
V <sub>REF</sub>	Reference input voltage	0		V <sub>DD</sub>	V
<b>AMPLIFIER FEEDBACK INPUT</b>					
V <sub>FB</sub>	Output amplifier feedback input		V <sub>OUT</sub>		V
<b>TEMPERATURE RANGE</b>					
T <sub>A</sub>	Operating ambient temperature	–40		125	°C

## 6.4 Thermal Information

THERMAL METRIC <sup>(1)</sup>		DAC8551-Q1 DAC6551-Q1	UNIT
		DGK (VSSOP)	
		8 PINS	
R <sub>θJA</sub>	Junction-to-ambient thermal resistance	173.7	°C/W
R <sub>θJC(top)</sub>	Junction-to-case (top) thermal resistance	65.4	°C/W
R <sub>θJB</sub>	Junction-to-board thermal resistance	94.2	°C/W
ψ <sub>JT</sub>	Junction-to-top characterization parameter	10.2	°C/W
ψ <sub>JB</sub>	Junction-to-board characterization parameter	92.7	°C/W

(1) For more information about traditional and new thermal metrics, see the [Semiconductor and IC Package Thermal Metrics](#) application report.

## 6.5 Electrical Characteristics

V<sub>DD</sub> = 3 V to 5.5 V, V<sub>REF</sub> = V<sub>DD</sub> and T<sub>A</sub> = –40°C to 125°C, unless otherwise noted.

PARAMETER	TEST CONDITIONS	MIN	TYP	MAX	UNIT
<b>STATIC PERFORMANCE<sup>(1)</sup></b>					
Resolution	DAC8551-Q1	16			Bits
	DAC6551-Q1	12			
Relative accuracy	DAC8551-Q1		±4	±16	LSB
	DAC6551-Q1		±0.3	±1	
Differential nonlinearity	DAC8551-Q1		±0.35	±2	LSB
	DAC6551-Q1		±0.02	±1	
Offset error			±1	±15	mV
Full-scale error			±0.05	±0.5	% of FSR
Gain error			±0.02	±0.2	% of FSR
Offset error drift			±5		μV/°C
Gain temperature coefficient			±1		ppm of FSR/°C

(1) Linearity calculated using a reduced code range of 485 to 64,741 (16-bit); 30 to 4,046 (12-bit); output unloaded.

**DAC8551-Q1, DAC6551-Q1**

SLASEB8C – FEBRUARY 2016 – REVISED NOVEMBER 2016

www.ti.com

**Electrical Characteristics (continued)** $V_{DD} = 3\text{ V to }5.5\text{ V}$ ,  $V_{REF} = V_{DD}$  and  $T_A = -40^\circ\text{C to }125^\circ\text{C}$ , unless otherwise noted.

PARAMETER		TEST CONDITIONS	MIN	TYP	MAX	UNIT
PSRR	Power-supply rejection ratio	$R_L = 2\text{ k}\Omega$ , $C_L = 200\text{ pF}$		0.75		mV/V
<b>OUTPUT CHARACTERISTICS<sup>(2)</sup></b>						
	Output voltage range		0		$V_{REF}$	V
	Output voltage settling time	To $\pm 0.003\%$ FSR, 0200h to FD00h $R_L = 2\text{ k}\Omega$ , $0\text{ pF} < C_L < 200\text{ pF}$		8		$\mu\text{s}$
	Slew rate			1.4		V/ $\mu\text{s}$
	Capacitive load stability	$R_L = \infty$		470		pF
		$R_L = 2\text{ k}\Omega$		1000		pF
	Code change glitch impulse	1 LSB change around major carry		0.1		nV-s
	Digital feedthrough	50 k $\Omega$ series resistance on digital lines		0.1		nV-s
	DC output impedance	At mid-code input		1		$\Omega$
	Short-circuit current	$V_{DD} = 3\text{ V to }5.5\text{ V}$		35		mA
<b>AC PERFORMANCE</b>						
SNR	Signal-to-noise ratio	BW = 20 kHz, $V_{DD} = 5\text{ V}$ , $V_{REF} = 4.5\text{ V}$ , $f_{OUT} = 1\text{ kHz}$ First 19 harmonics removed for SNR calculation		84		dB
THD	Total harmonic distortion			-80		dB
SFDR	Spurious-free dynamic range			84		dB
SINAD	Signal to noise and distortion			76		dB
<b>REFERENCE INPUT</b>						
	Reference current	$V_{REF} = V_{DD} = 5.5\text{ V}$		50		$\mu\text{A}$
		$V_{REF} = V_{DD} = 3.6\text{ V}$		25		
	Reference input range		0		$V_{DD}$	V
	Reference input impedance			125		k $\Omega$
<b>LOGIC INPUTS<sup>(2)</sup></b>						
	Input current			$\pm 1$		$\mu\text{A}$
$V_{INL}$	Input low voltage				$0.3 \times V_{DD}$	V
$V_{INH}$	Input high voltage		$0.7 \times V_{DD}$			V
	Pin capacitance			3		pF
<b>POWER REQUIREMENTS</b>						
$V_{DD}$	Supply voltage		3		5.5	V
$I_{DD}$	Supply current	Normal mode, midscale code, no load, does not include reference current. $V_{IH} = V_{DD}$ and $V_{IL} = \text{GND}$ , $V_{DD} = 3.6\text{ V to }5.5\text{ V}$		160	250	$\mu\text{A}$
		Normal mode, midscale code, no load, does not include reference current. $V_{IH} = V_{DD}$ and $V_{IL} = \text{GND}$ , $V_{DD} = 3\text{ V to }3.6\text{ V}$		110	240	
		All power-down modes, $V_{IH} = V_{DD}$ and $V_{IL} = \text{GND}$ , $V_{DD} = 3.6\text{ V to }5.5\text{ V}$		0.8	3	
		All power-down modes, $V_{IH} = V_{DD}$ and $V_{IL} = \text{GND}$ , $V_{DD} = 3\text{ V to }3.6\text{ V}$		0.5	3	
<b>POWER EFFICIENCY</b>						
	$I_{OUT} / I_{DD}$	$I_{LOAD} = 2\text{ mA}$ , $V_{DD} = 5\text{ V}$		89%		
<b>TEMPERATURE RANGE</b>						
$T_A$	Ambient temperature		-40		125	$^\circ\text{C}$

(2) Specified by design and characterization; not production tested.

## 6.6 Timing Requirements<sup>(1)(2)</sup>

$V_{DD} = 3\text{ V to }5.5\text{ V}$  and  $T_A = -40^\circ\text{C to }125^\circ\text{C}$ , unless otherwise noted.

PARAMETER		TEST CONDITIONS	MIN	NOM	MAX	UNIT
$f_{SCLK}$	Serial clock frequency	$V_{DD} = 3\text{ V to }3.6\text{ V}$			25	MHz
		$V_{DD} = 3.6\text{ V to }5.5\text{ V}$			30	
$t_1$	SCLK cycle time	$V_{DD} = 3\text{ V to }3.6\text{ V}$	40			ns
		$V_{DD} = 3.6\text{ V to }5.5\text{ V}$	34			
$t_2$	SCLK high time	$V_{DD} = 3\text{ V to }3.6\text{ V}$	13			ns
		$V_{DD} = 3.6\text{ V to }5.5\text{ V}$	13			
$t_3$	SCLK low time	$V_{DD} = 3\text{ V to }3.6\text{ V}$	13			ns
		$V_{DD} = 3.6\text{ V to }5.5\text{ V}$	13			
$t_4$	$\overline{SYNC}$ to SCLK rising edge setup time	$V_{DD} = 3\text{ V to }3.6\text{ V}$	0			ns
		$V_{DD} = 3.6\text{ V to }5.5\text{ V}$	0			
$t_5$	Data setup time	$V_{DD} = 3\text{ V to }3.6\text{ V}$	5			ns
		$V_{DD} = 3.6\text{ V to }5.5\text{ V}$	5			
$t_6$	Data hold time	$V_{DD} = 3\text{ V to }3.6\text{ V}$	5			ns
		$V_{DD} = 3.6\text{ V to }5.5\text{ V}$	5			
$t_7$	24th SCLK falling edge to $\overline{SYNC}$ rising edge	$V_{DD} = 3\text{ V to }3.6\text{ V}$	0			ns
		$V_{DD} = 3.6\text{ V to }5.5\text{ V}$	0			
$t_8$	Minimum $\overline{SYNC}$ high time	$V_{DD} = 3\text{ V to }3.6\text{ V}$	50			ns
		$V_{DD} = 3.6\text{ V to }5.5\text{ V}$	34			
$t_9$	24th SCLK falling edge to $\overline{SYNC}$ falling edge	$V_{DD} = 3\text{ V to }5.5\text{ V}$	50			ns

(1) All input signals are specified with  $t_R = t_F = 5\text{ ns}$  (10% to 90% of  $V_{DD}$ ) and timed from a voltage level of  $(V_{IL} + V_{IH}) / 2$ .

(2) See the [Serial-Write-Operation Timing Diagram](#).

## 6.7 Switching Characteristics

over operating ambient temperature range (unless otherwise noted)

PARAMETER	TEST CONDITIONS	MIN	TYP	MAX	UNIT
Power-up time	Coming out of power-down mode, $V_{DD} = 5\text{ V}$		2.5		$\mu\text{s}$
	Coming out of power-down mode, $V_{DD} = 3.3\text{ V}$		5		

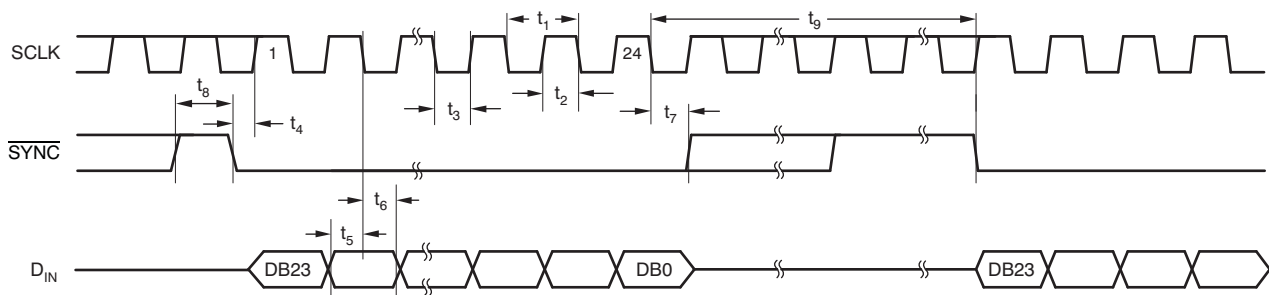

Figure 1. Serial-Write-Operation Timing Diagram

**DAC8551-Q1, DAC6551-Q1**

SLASEB8C – FEBRUARY 2016 – REVISED NOVEMBER 2016

www.ti.com

**6.8 Typical Characteristics**

At  $T_A = 25^\circ\text{C}$ ,  $V_{DD} = 5\text{ V}$  unless otherwise noted.

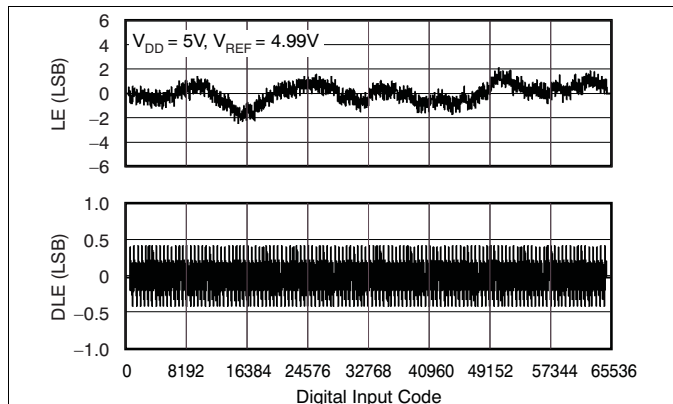

**Figure 2. Linearity Error and Differential Linearity Error vs Digital Input Code ( $-40^\circ\text{C}$ )**

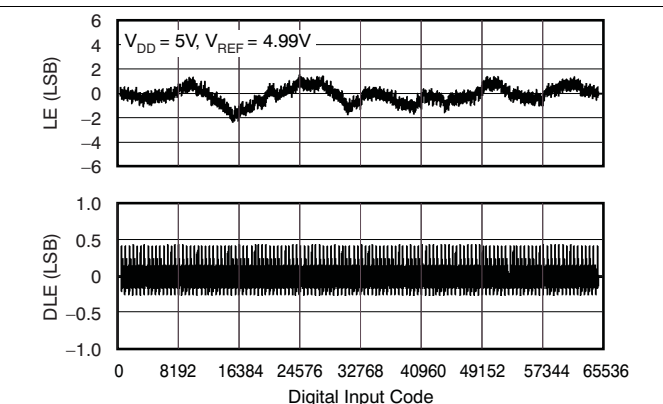

**Figure 3. Linearity Error and Differential Linearity Error vs Digital Input Code ( $25^\circ\text{C}$ )**

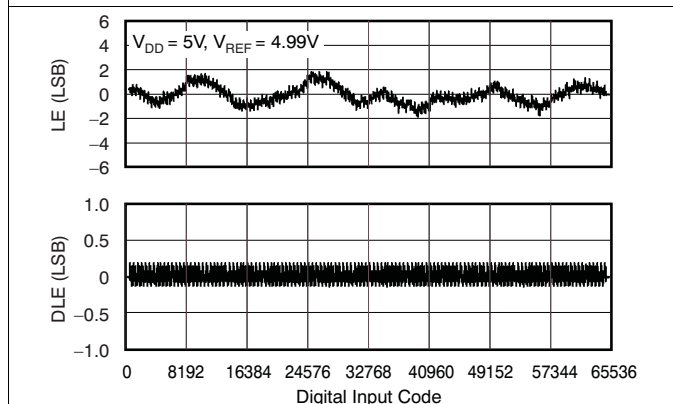

**Figure 4. Linearity Error and Differential Linearity Error vs Digital Input Code ( $125^\circ\text{C}$ )**

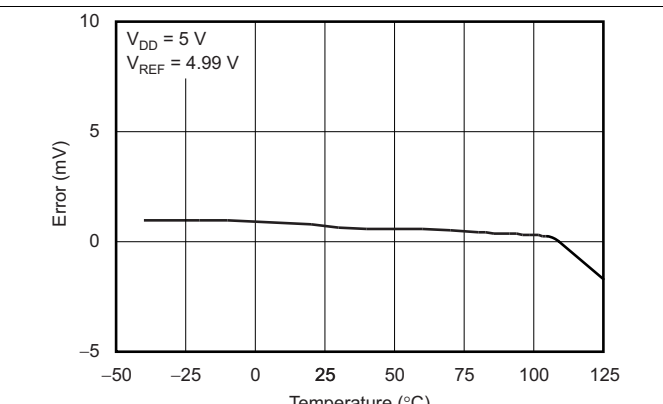

**Figure 5. Offset Error vs Temperature**

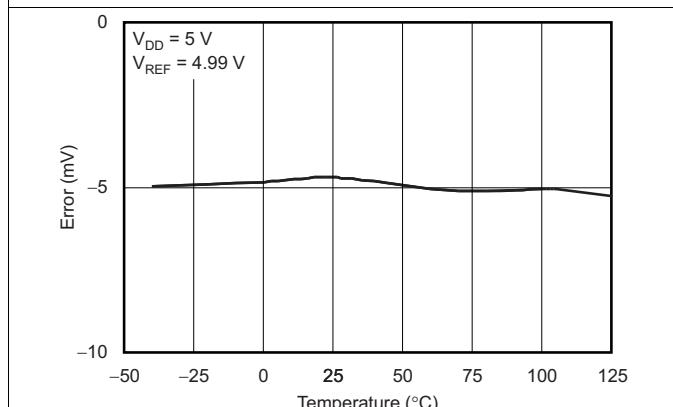

**Figure 6. Full-Scale Error vs Temperature**

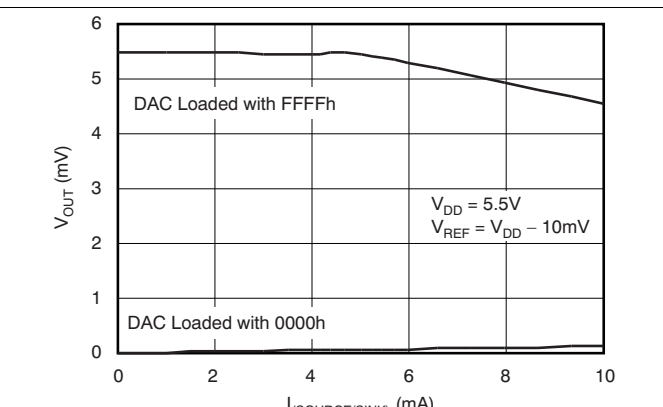

**Figure 7. Source and Sink Current Capability**

**Typical Characteristics (continued)**

At  $T_A = 25^\circ\text{C}$ ,  $V_{DD} = 5\text{ V}$  unless otherwise noted.

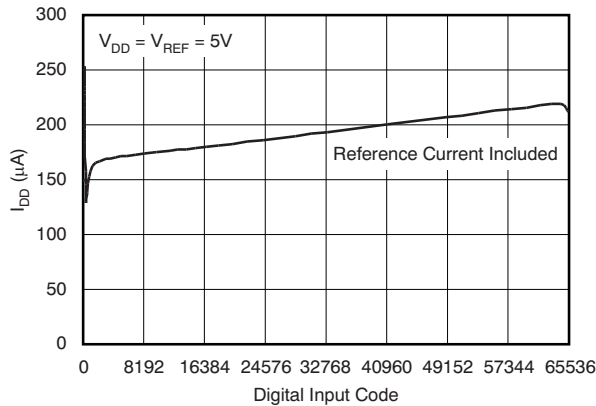

**Figure 8. Supply Current vs Digital Input Code**

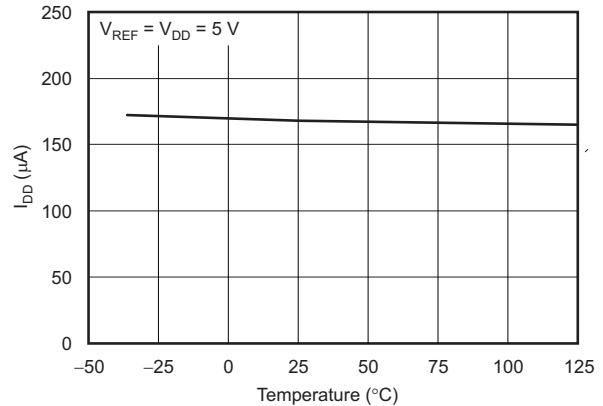

**Figure 9. Power-Supply Current vs Temperature**

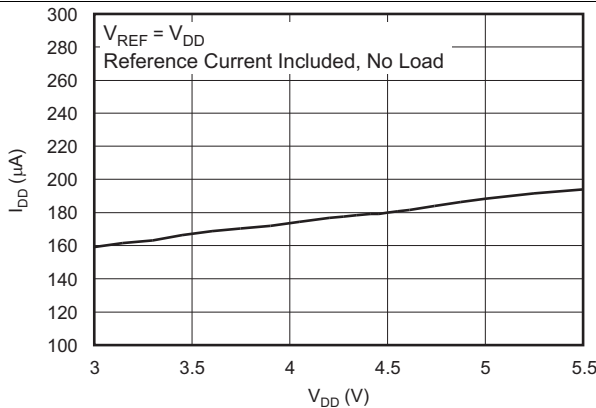

**Figure 10. Supply Current vs Supply Voltage**

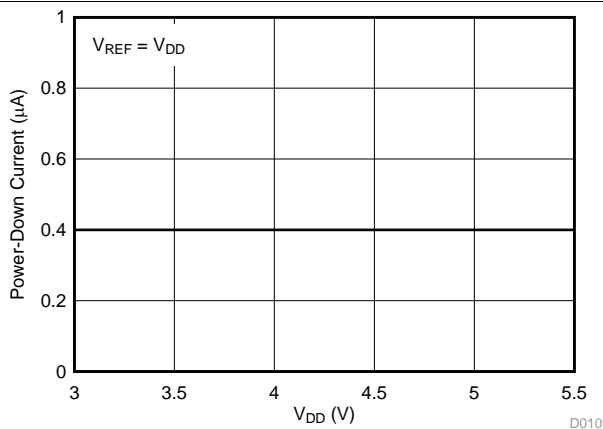

**Figure 11. Power-Down Current vs Supply Voltage**

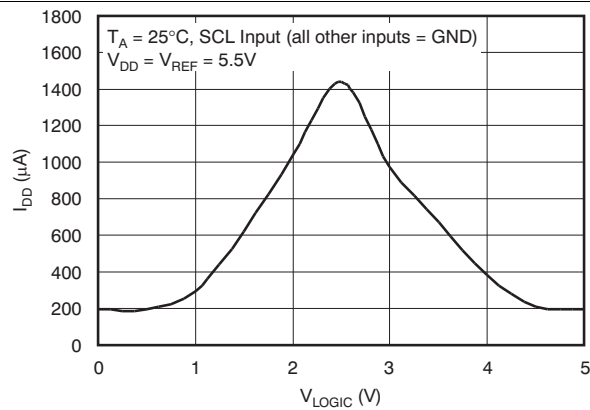

**Figure 12. Supply Current vs Logic Input Voltage**

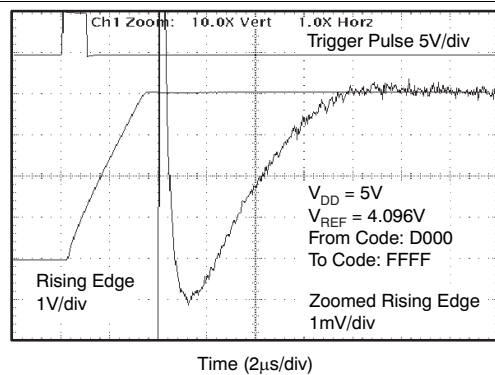

**Figure 13. Full-Scale Settling Time: 5-V Rising Edge**

**DAC8551-Q1, DAC6551-Q1**

SLASEB8C – FEBRUARY 2016 – REVISED NOVEMBER 2016

www.ti.com

**Typical Characteristics (continued)**

At  $T_A = 25^\circ\text{C}$ ,  $V_{DD} = 5\text{ V}$  unless otherwise noted.

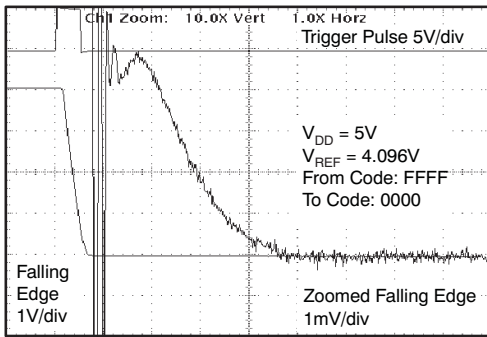

Time (2µs/div)

**Figure 14. Full-Scale Settling Time: 5-V Falling Edge**

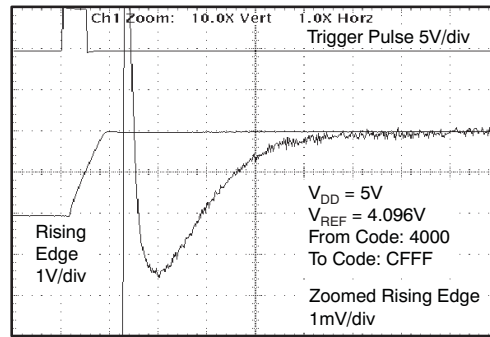

Time (2µs/div)

**Figure 15. Half-Scale Settling Time: 5-V Rising Edge**

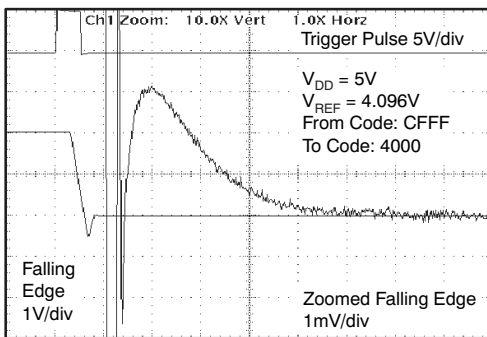

Time (2µs/div)

**Figure 16. Half-Scale Settling Time: 5-V Falling Edge**

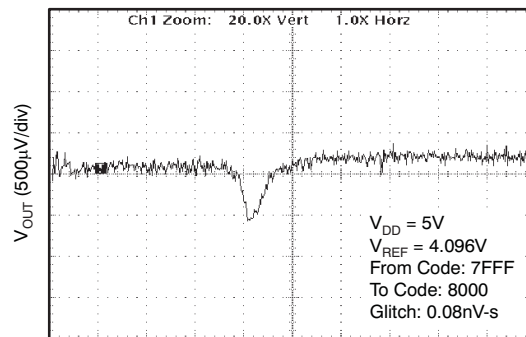

Time (400ns/div)

**Figure 17. Glitch Impulse: 5 V, 1-LSB Step, Rising Edge**

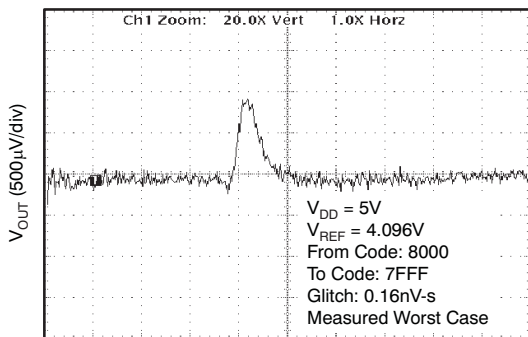

Time (400ns/div)

**Figure 18. Glitch Impulse: 5 V, 1-LSB Step, Falling Edge**

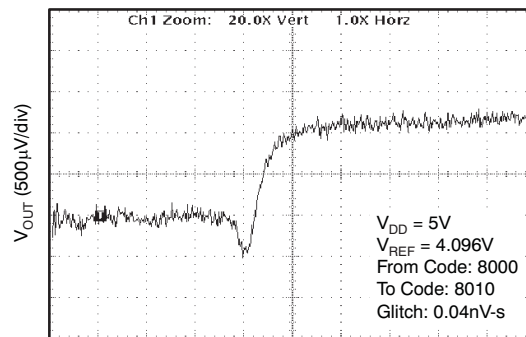

Time (400ns/div)

**Figure 19. Glitch Impulse: 5 V, 16-LSB Step, Rising Edge**

Typical Characteristics (continued)

At  $T_A = 25^\circ\text{C}$ ,  $V_{DD} = 5\text{ V}$  unless otherwise noted.

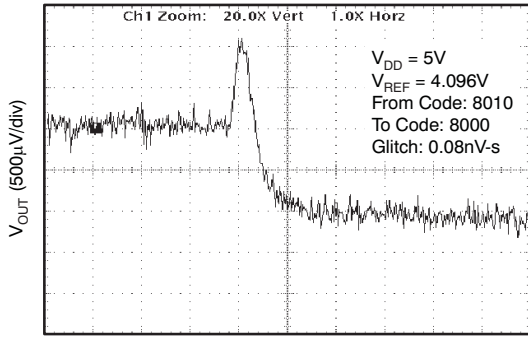

Figure 20. Glitch Impulse: 5 V, 16-LSB Step, Falling Edge

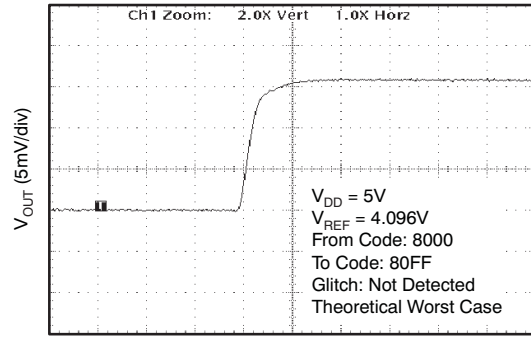

Figure 21. Glitch Impulse: 5 V, 256-LSB Step, Rising Edge

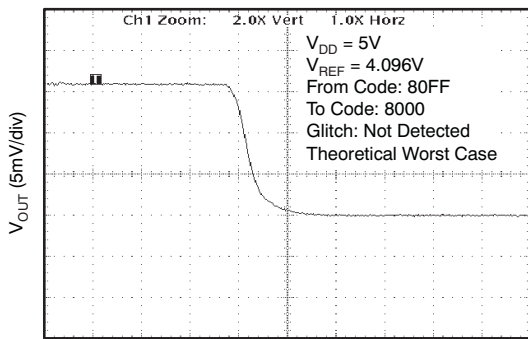

Figure 22. Glitch Impulse: 5 V, 256-LSB Step, Falling Edge

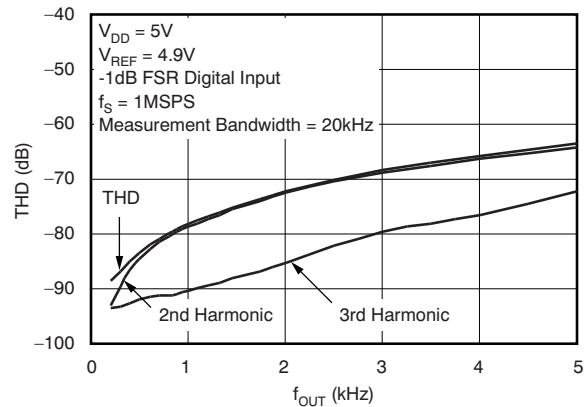

Figure 23. Total Harmonic Distortion vs Output Frequency

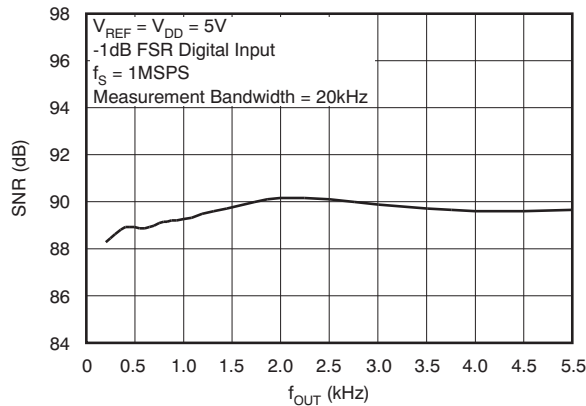

Figure 24. Signal-to-Noise Ratio vs Output Frequency

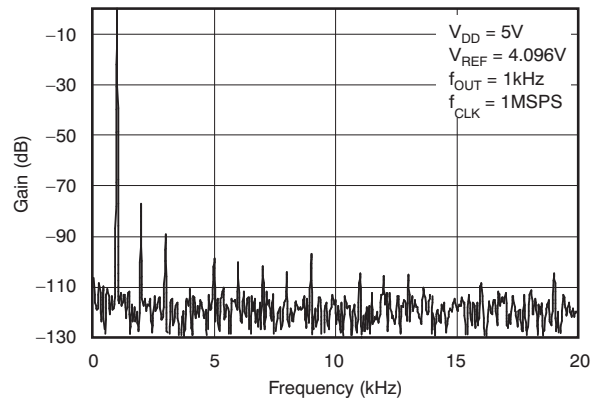
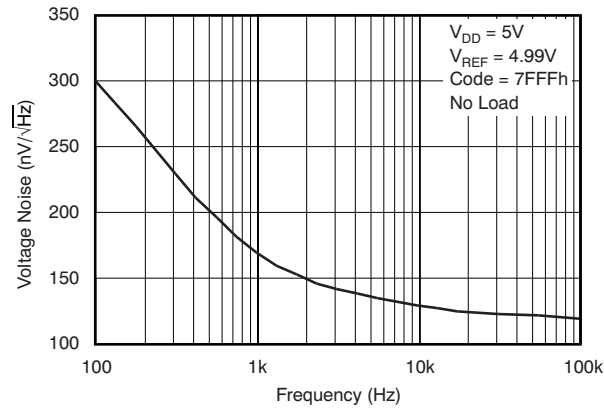

Figure 25. Power Spectral Density

**DAC8551-Q1, DAC6551-Q1**

SLASEB8C – FEBRUARY 2016 – REVISED NOVEMBER 2016

[www.ti.com](http://www.ti.com)**Typical Characteristics (continued)**At  $T_A = 25^\circ\text{C}$ ,  $V_{DD} = 5\text{ V}$  unless otherwise noted.**Figure 26. Output Noise Density**

## 7 Detailed Description

### 7.1 Overview

The DAC8551-Q1 and DAC6551-Q1 are small, low-power, voltage-output, 16- and 12-bit digital-to-analog converters (DACs) qualified for automotive applications. The DACx551-Q1 devices provide good linearity and minimize undesired code-to-code transient voltages. The devices use a versatile 3-wire serial interface that operates at clock rates to 30 MHz and is compatible with standard SPI, QSPI, Microwire, and digital signal processor (DSP) interfaces.

The DACx551-Q1 devices require an external reference voltage to set the output range. The devices incorporate a power-on-reset circuit that ensures the DAC output powers up at 0 V and remains there until a valid write to the device takes place. The devices contain a power-down feature, accessed over the serial interface, that reduces the current consumption to 800 nA at 5 V.

The DACx551-Q1 devices power consumption is only 800  $\mu$ W at 5 V, reducing to less than 4  $\mu$ W in power-down mode. The DACx551-Q1 devices are available in a VSSOP-8 package.

### 7.2 Functional Block Diagram

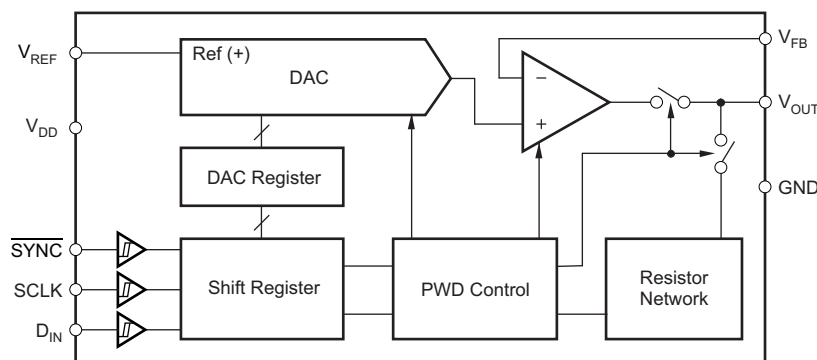

Copyright © 2016, Texas Instruments Incorporated

### 7.3 Feature Description

#### 7.3.1 DAC Section

The DACx551-Q1 architecture consists of a string DAC followed by an output buffer amplifier. Figure 27 shows a block diagram of the DAC architecture.

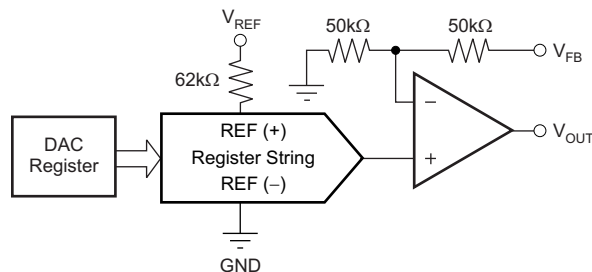

Copyright © 2016, Texas Instruments Incorporated

**Figure 27. DACx551-Q1 Architecture**

The input coding to the DACx551-Q1 is straight binary, so the ideal output voltage is given by:

$$V_{\text{OUT}} = \frac{D_{\text{IN}}}{2^{n-1}} \times V_{\text{REF}} \quad (1)$$

## DAC8551-Q1, DAC6551-Q1

SLASEB8C – FEBRUARY 2016 – REVISED NOVEMBER 2016

www.ti.com

### Feature Description (continued)

where:

- $n$  = resolution in bits; 12 (DAC6551-Q1) or 16 (DAC8551-Q1)
- $D_{IN}$  = decimal equivalent of the binary code that is loaded to the DAC register; it can range from 0 to  $2^{n-1}$ .

#### 7.3.1.1 Resistor String

The resistor string section is shown in Figure 28. It is simply a string of resistors, each of value  $R$ . The code loaded into the DAC register determines at which node on the string the voltage is tapped off to be fed into the output amplifier by closing one of the switches connecting the string to the amplifier.

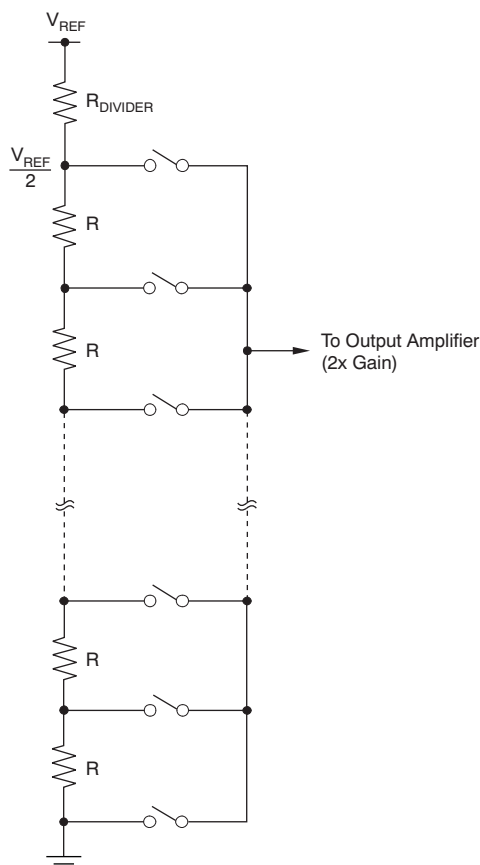

Figure 28. Resistor String

#### 7.3.1.2 Output Amplifier

The output buffer amplifier is capable of generating rail-to-rail voltages on its output, giving an output range of 0 V to  $V_{DD}$ . It is capable of driving a load of 2 k $\Omega$  in parallel with 1000 pF to GND. The source and sink capabilities of the output amplifier can be seen in the [Typical Characteristics](#). The slew rate is 1.4 V/ $\mu$ s with a full-scale setting time of 8  $\mu$ s with the output unloaded.

The inverting input of the output amplifier is brought out to the  $V_{FB}$  pin. This configuration allows for better accuracy in critical applications by tying the  $V_{FB}$  point and the amplifier output together directly at the load. Other signal conditioning circuitry may also be connected between these points for specific applications.

#### 7.3.2 Power-On Reset

The DACx551-Q1 contains a power-on-reset circuit that controls the output voltage during power up. On power up, the DAC registers are filled with zeros and the output voltages are 0 V; they remain that way until a valid write sequence is made to the DAC. The power-on reset is useful in applications where it is important to know the state of the output of the DAC while it is in the process of powering up.

## 7.4 Device Functional Modes

### 7.4.1 Power-Down Modes

The DACx551-Q1 supports four separate modes of operation. These modes are programmable by setting two bits (PD1 and PD0) in the control register. [Table 1](#) shows how the state of the bits corresponds to the mode of operation of the device.

**Table 1. Operating Modes**

PD1 (DB17)	PD0 (DB16)	OPERATING MODE
0	0	Normal operation
—	—	Power-down modes
0	1	Output typically 1 kΩ to GND
1	0	Output typically 100 kΩ to GND
1	1	High-Z

When both bits are set to 0, the device works normally with its typical current consumption of 160  $\mu\text{A}$  at 5 V. However, for the three power-down modes, the supply current falls to 800 nA at 5 V. Not only does the supply current fall, but the output stage is also internally switched from the output of the amplifier to a resistor network of known values. This configuration has the advantage that the output impedance of the device is known while it is in power-down mode. There are three different options. The output is connected internally to GND through a 1-k $\Omega$  resistor, a 100-k $\Omega$  resistor, or it is left open-circuited (High-Z). The output stage is illustrated in [Figure 29](#).

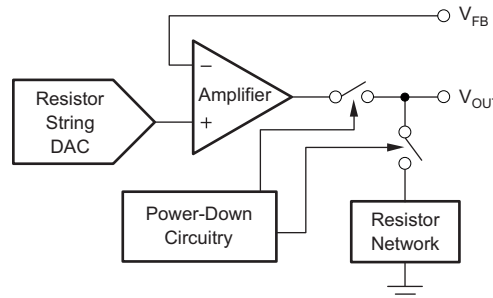

Copyright © 2016, Texas Instruments Incorporated

**Figure 29. Output Stage During Power Down**

All analog circuitry is shut down when the power-down mode is activated. However, the contents of the DAC register are unaffected when in power down. The time to exit power-down is typically 2.5  $\mu\text{s}$  for  $V_{\text{DD}} = 5 \text{ V}$ , and 5  $\mu\text{s}$  for  $V_{\text{DD}} = 3 \text{ V}$ . See the [Typical Characteristics](#) for more information.

## DAC8551-Q1, DAC6551-Q1

SLASEB8C – FEBRUARY 2016 – REVISED NOVEMBER 2016

www.ti.com

### 7.5 Programming

The DAC8551-Q1 and DAC6551-Q1 devices have a 3-wire serial interface ( $\overline{\text{SYNC}}$ , SCLK, and  $\text{D}_{\text{IN}}$ ), which is compatible with SPI, QSPI, and Microwire interface standards, as well as most DSPs. See the [Serial Write Operation Timing Diagram](#) section for an example of a typical write sequence.

The input shift register is 24 bits wide, as shown in [Figure 30](#) and [Figure 31](#). The first six bits are *don't care* bits. The next two bits (PD1 and PD0) are control bits that control which mode of operation the part is in (normal mode or any one of three power-down modes). A more complete description of the various modes is located in the [Power-Down Modes](#) section. The next 16 bits are the left aligned data bits. These bits are transferred to the DAC register on the 24th falling edge of SCLK.

DB23																		DB0					
X	X	X	X	X	X	PD1	PD0	D15	D14	D13	D12	D11	D10	D9	D8	D7	D6	D5	D4	D3	D2	D1	D0

**Figure 30. DAC8551-Q1 Data-Input Register Format**

DB23																		DB0					
X	X	X	X	X	X	PD1	PD0	D11	D10	D9	D8	D7	D6	D5	D4	D3	D2	D1	D0	0	0	0	0

**Figure 31. DAC6551-Q1 Data-Input Register Format**

The write sequence begins by bringing the  $\overline{\text{SYNC}}$  line low. Data from the  $\text{D}_{\text{IN}}$  line are clocked into the 24-bit shift register on each falling edge of SCLK. The serial clock frequency can be as high as 30 MHz, making the devices compatible with high-speed DSPs. On the 24th falling edge of the serial clock, the last data bit is clocked in and the programmed function is executed (that is, a change in DAC register contents and/or a change in the mode of operation).

At this point, the  $\overline{\text{SYNC}}$  line may be kept low or brought high. In either case, it must be brought high for a minimum of 33 ns before the next write sequence so that a falling edge of  $\overline{\text{SYNC}}$  can initiate the next write sequence. As previously mentioned, it must be brought high again just before the next write sequence.

#### 7.5.1 $\overline{\text{SYNC}}$ Interrupt

In a normal write sequence, the  $\overline{\text{SYNC}}$  line is kept low for at least 24 falling edges of SCLK, and the DAC is updated on the 24th falling edge. However, if  $\overline{\text{SYNC}}$  is brought high before the 24th falling edge, it acts as an interrupt to the write sequence. The shift register is reset, and the write sequence is seen as invalid. Neither an update of the DAC register contents nor a change in the operating mode occurs, as shown in [Figure 32](#).

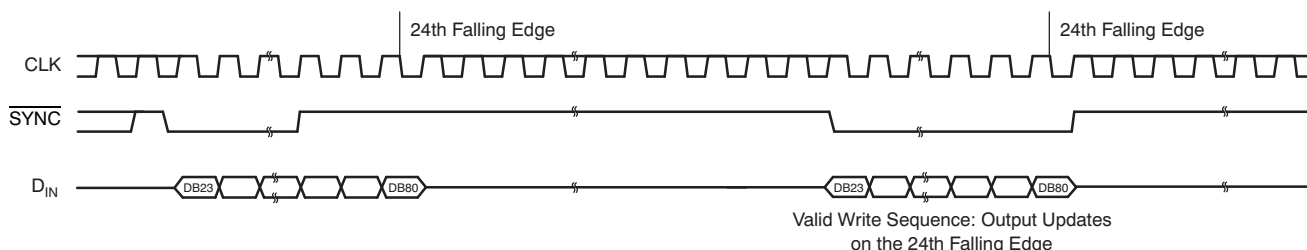

**Figure 32.  $\overline{\text{SYNC}}$  Interrupt Facility**

## 8 Application and Implementation

### NOTE

Information in the following applications sections is not part of the TI component specification, and TI does not warrant its accuracy or completeness. TI's customers are responsible for determining suitability of components for their purposes. Customers should validate and test their design implementation to confirm system functionality.

### 8.1 Application Information

The DAC8551-Q1 and DAC6551-Q1 devices are AEC-Q100 qualified, low-power, ultralow-glitch, 16-bit and 12-bit DACs, respectively. The wide temperature range, low-power consumption and very low glitch of the devices make them a great choice for automotive applications such as radar and sensor conditioning.

### 8.2 Typical Applications

#### 8.2.1 Loop-Powered 2-Wire 4-mA to 20-mA Transmitter With XTR116

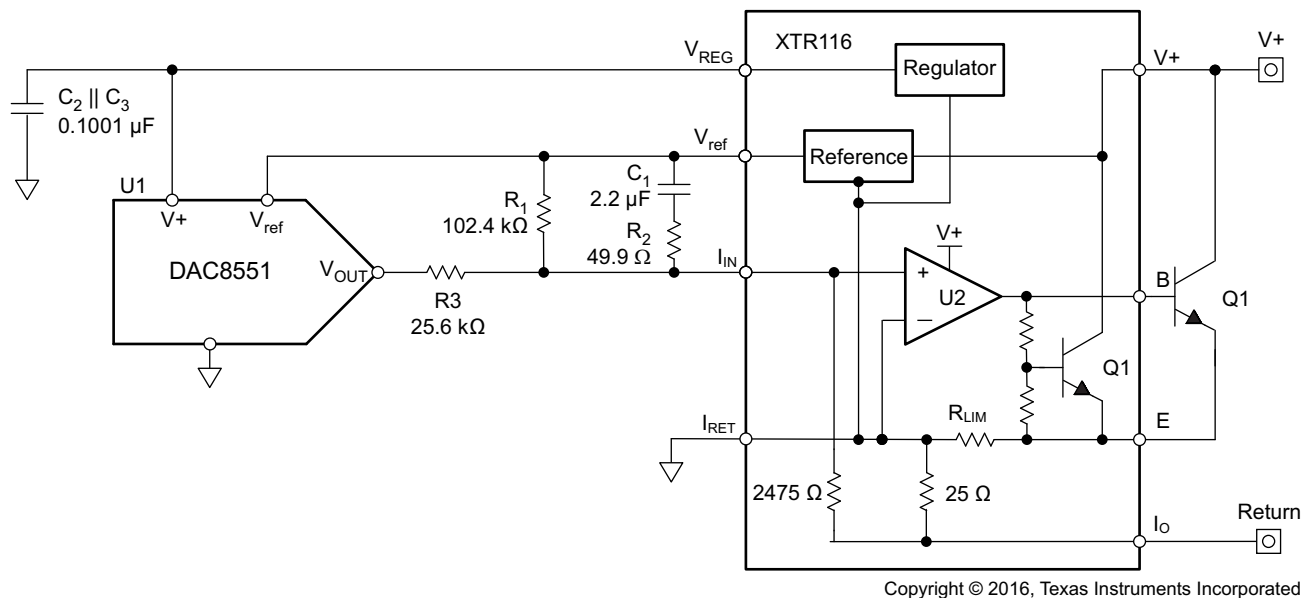

Figure 33. Loop-Powered Transmitter

#### 8.2.1.1 Design Requirements

This design is commonly referred to as a loop-powered, or 2-wire, 4 mA to 20 mA transmitter. The transmitter has only two external input terminals: a supply connection and an output, or return, connection. The transmitter communicates back to its host, typically a PLC analog input module, by precisely controlling the magnitude of its return current. In order to conform to the 4 mA to 20 mA communication standard, the complete transmitter must consume less than 4 mA of current. The DAC8551-Q1 device enables the accurate control of the loop current from 4 mA to 20 mA in 16-bit steps.

#### 8.2.1.2 Detailed Design Procedure

Although it is possible to recreate the loop-powered circuit using discrete components, the XTR116 provides simplicity and improved performance due to the matched internal resistors. The output current can be modified if necessary by looking using Equation 2.

$$I_{OUT}(\text{Code}) = \left( \frac{V_{ref} \times \text{Code}}{2^N \times R_3} + \frac{V_{REG}}{R_1} \right) \times \left( 1 + \frac{2475 \Omega}{25 \Omega} \right) \quad (2)$$

**DAC8551-Q1, DAC6551-Q1**

SLASEB8C – FEBRUARY 2016 – REVISED NOVEMBER 2016

www.ti.com

**Typical Applications (continued)**

For more details of this application, see *2-wire, 4-20mA Transmitter, EMC/EMI Tested Reference Design (TIDUA07)*. It covers in detail the design of this circuit as well as how to protect it from EMC/EMI tests.

**8.2.1.3 Application Curves**

Total unadjusted error (TUE) is a good estimate for the performance of the output as shown in [Figure 34](#). The linearity of the output or INL is in [Figure 35](#).

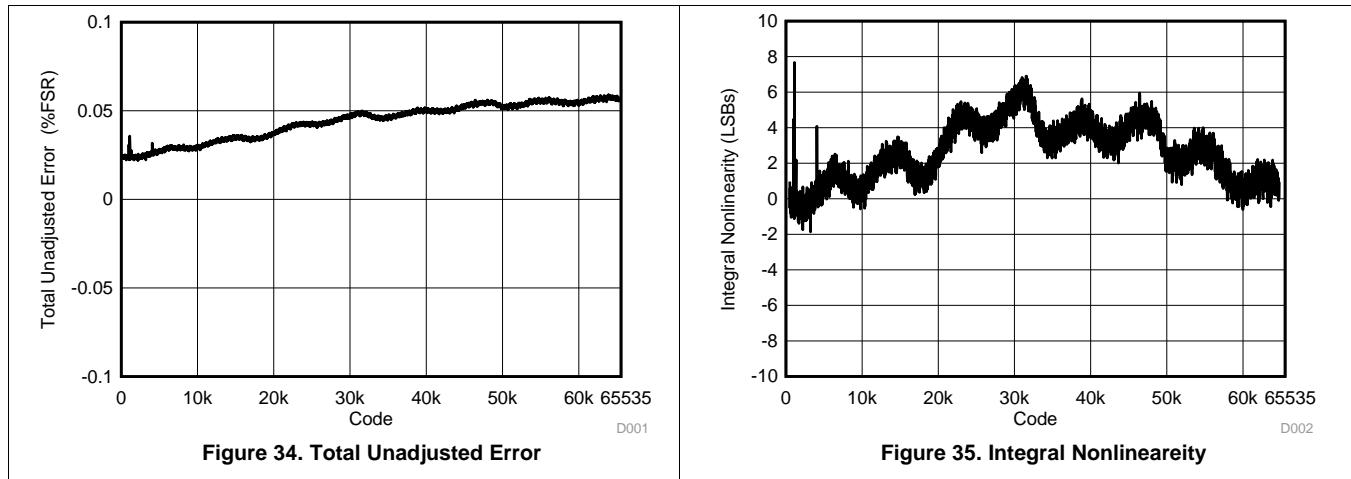
**8.2.2 Bipolar Operation Using the DAC8551-Q1 Device**

The DAC8551-Q1 device has been designed for single-supply operation, but a bipolar output range is also possible using the circuit in [Figure 36](#). The circuit shown gives an output voltage range of  $\pm V_{REF}$ . Rail-to-rail operation at the amplifier output is achievable using an [OPA703](#) as the output amplifier.

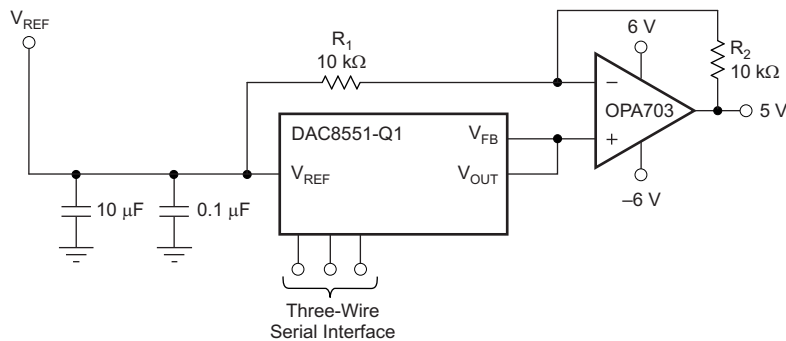
**Figure 36. Bipolar Output Range**

The output voltage for any input code can be calculated as follows:

$$V_O = \left[ V_{REF} \times \left( \frac{D}{65536} \right) \times \left( \frac{R_1 + R_2}{R_1} \right) - V_{REF} \times \left( \frac{R_2}{R_1} \right) \right] \quad (3)$$

where D represents the input code in decimal (0–65,535)

with  $V_{REF} = 5V$ ,  $R_1 = R_2 = 10\text{ k}\Omega$ .

$$V_O = \left( \frac{10 \times D}{65536} \right) - 5\text{ V} \quad (4)$$

Using this example, an output voltage range of  $\pm 5$  V with 0000h corresponding to a  $-5$  V output and FFFFh corresponding to a  $5$  V output can be achieved. Similarly, using  $V_{REF} = 2.5$  V, a  $\pm 2.5$  V output voltage range can be achieved.

### 8.2.3 Using the REF02 As a Power Supply for the DACx551-Q1

Due to the extremely low supply current required by the DACx551-Q1, an alternative option is to use a precision reference such as the REF02 device to supply the required voltage to the device, as illustrated in Figure 37.

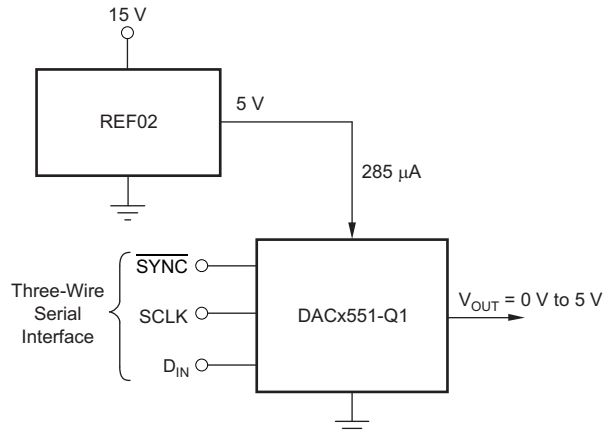

**Figure 37. REF02 As a Power Supply to the DACx551-Q1**

This configuration is especially useful if the power supply is quite noisy or if the system supply voltages are at some value other than 5 V. The REF02 device outputs a steady supply voltage for the device. If the REF02 device is used, the current it must supply to the device is 200 µA. This configuration is with no load on the output of the DAC. When a DAC output is loaded, the REF02 also must supply the current to the load.

The total current required (with a 5 kΩ load on the DAC output) is:

$$200\mu\text{A} + \frac{5\text{V}}{5\text{k}\Omega} = 1.2\text{mA} \quad (5)$$

The load regulation of the REF02 is typically 0.005%/mA, resulting in an error of 299 µV for the 1.2 mA current drawn from it. This value corresponds to a 3.9 LSB error.

## DAC8551-Q1, DAC6551-Q1

SLASEB8C – FEBRUARY 2016 – REVISED NOVEMBER 2016

www.ti.com

### 8.3 System Examples

#### 8.3.1 Interface From the DACx551-Q1 to 8051

See [Figure 38](#) for a serial interface between the DACx551-Q1 and a typical 8051-type microcontroller. The setup for the interface is as follows: TXD of the 8051 drives SCLK of the DACx551-Q1, whereas RXD drives the serial data line of the device. The  $\overline{\text{SYNC}}$  signal is derived from a bit-programmable pin on the port of the 8051. In this case, port line P3.3 is used. When data are to be transmitted to the DACx551-Q1, P3.3 is taken low. The 8051 transmits data in 8-bit bytes; thus, only eight falling clock edges occur in the transmit cycle. To load data to the DAC, P3.3 is left low after the first eight bits are transmitted, then a second write cycle is initiated to transmit the second byte of data. P3.3 is taken high following the completion of the third write cycle. The 8051 outputs the serial data in a format that has the LSB first. The DACx551-Q1 requires data with the MSB as the first bit received. Therefore, the 8051 transmit routine must take this into account, and *mirror* the data as needed.

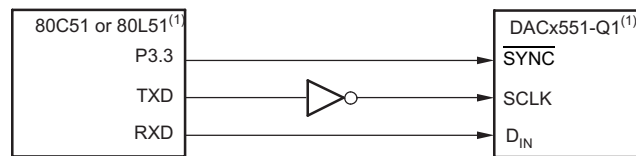

NOTE: (1) Additional pins omitted for clarity.

**Figure 38. Interface From the DACx551-Q1 to 80C51 or 80L51**

#### 8.3.2 Interface From the DACx551-Q1 to Microwire

[Figure 39](#) shows an interface between the DACx551-Q1 and any Microwire-compatible device. Serial data are shifted out on the falling edge of the serial clock and is clocked into the DACx551-Q1 on the rising edge of the SK signal.

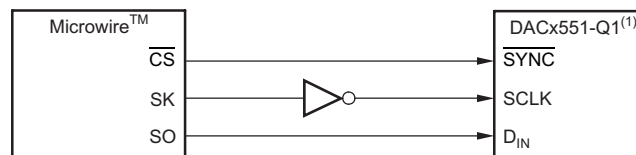

NOTE: (1) Additional pins omitted for clarity.

**Figure 39. Interface From the DACx551-Q1 to Microwire**

#### 8.3.3 Interface From the DACx551-Q1 to 68HC11

[Figure 40](#) shows a serial interface between the DACx551-Q1 and the 68HC11 microcontroller. SCK of the 68HC11 drives SCLK of the DACx551-Q1, whereas the MOSI output drives the serial data line of the DAC. The SYNC signal is derived from a port line (PC7), similar to the 8051 diagram.

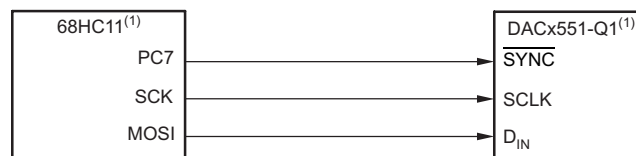

NOTE: (1) Additional pins omitted for clarity.

**Figure 40. Interface From the DACx551-Q1 to 68HC11**

The 68HC11 should be configured so that its CPOL bit is 0 and its CPHA bit is 1. This configuration causes data appearing on the MOSI output to be valid on the falling edge of SCK. When data are being transmitted to the DAC, the SYNC line is held low (PC7). Serial data from the 68HC11 are transmitted in 8-bit bytes with only eight falling clock edges occurring in the transmit cycle. (Data are transmitted MSB first.) In order to load data to the DACx551-Q1, PC7 is left low after the first eight bits are transferred, then a second and third serial write operation are performed to the DAC. PC7 is taken high at the end of this procedure.

## 9 Power Supply Recommendations

The DACx551-Q1 can operate within the specified supply voltage range of 3 V to 5.5 V. The power applied to  $V_{DD}$  should be well-regulated and low-noise. Switching power supplies and dc/dc converters often have high-frequency glitches or spikes riding on the output voltage. In addition, digital components can create similar high-frequency spikes. This noise can easily couple into the DAC output voltage through various paths between the power connections and analog output. In order to further minimize noise from the power supply, a strong recommendation is to include a 1- $\mu$ F to 10- $\mu$ F capacitor and 0.1- $\mu$ F bypass capacitor. The current consumption on the  $V_{DD}$  pin, the short-circuit current limit, and the load current for the device is listed in the Electrical Characteristics table. The power supply must meet the aforementioned current requirements.

## 10 Layout

### 10.1 Layout Guidelines

A precision analog component requires careful layout, adequate bypassing, and clean, well-regulated power supplies.

The DACx551-Q1 offers single-supply operation, and is often used in close proximity with digital logic, microcontrollers, microprocessors, and digital signal processors. The more digital logic present in the design and the higher the switching speed, the more difficult it is to keep digital noise from appearing at the output.

Due to the single ground pin of the DACx551-Q1, all return currents, including digital and analog return currents for the DAC, must flow through a single point. Ideally, GND would be connected directly to an analog ground plane. This plane would be separate from the ground connection for the digital components until they were connected at the power-entry point of the system.

As with the GND connection,  $V_{DD}$  should be connected to a power-supply plane or trace that is separate from the connection for digital logic until they are connected at the power-entry point. In addition, a 1  $\mu$ F to 10  $\mu$ F capacitor and 0.1  $\mu$ F bypass capacitor are strongly recommended. In some situations, additional bypassing may be required, such as a 100  $\mu$ F electrolytic capacitor or even a *Pi* filter made up of inductors and capacitors—all designed to essentially low-pass filter the 5 V supply, removing the high-frequency noise.

### 10.2 Layout Example

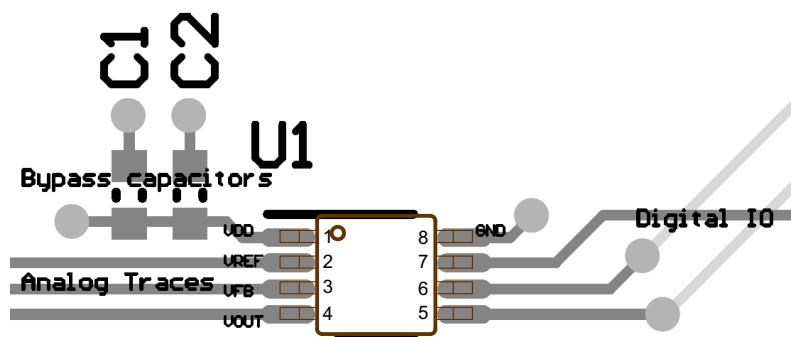

Figure 41. Layout Diagram

## DAC8551-Q1, DAC6551-Q1

SLASEB8C – FEBRUARY 2016 – REVISED NOVEMBER 2016

www.ti.com

## 11 Device and Documentation Support

### 11.1 Documentation Support

#### 11.1.1 Related Documentation

*2-wire, 4-20mA Transmitter, EMC/EMI Tested Reference Design (TIDUA07)*

### 11.2 Receiving Notification of Documentation Updates

To receive notification of documentation updates, navigate to the device product folder on ti.com. In the upper right corner, click on *Alert me* to register and receive a weekly digest of any product information that has changed. For change details, review the revision history included in any revised document.

### 11.3 Community Resources

The following links connect to TI community resources. Linked contents are provided "AS IS" by the respective contributors. They do not constitute TI specifications and do not necessarily reflect TI's views; see TI's [Terms of Use](#).

**TI E2E™ Online Community** *TI's Engineer-to-Engineer (E2E) Community*. Created to foster collaboration among engineers. At e2e.ti.com, you can ask questions, share knowledge, explore ideas and help solve problems with fellow engineers.

**Design Support** *TI's Design Support* Quickly find helpful E2E forums along with design support tools and contact information for technical support.

### 11.4 Trademarks

E2E is a trademark of Texas Instruments.  
All other trademarks are the property of their respective owners.

### 11.5 Electrostatic Discharge Caution



These devices have limited built-in ESD protection. The leads should be shorted together or the device placed in conductive foam during storage or handling to prevent electrostatic damage to the MOS gates.

### 11.6 Glossary

[SLYZ022](#) — *TI Glossary*.

This glossary lists and explains terms, acronyms, and definitions.

## 12 Mechanical, Packaging, and Orderable Information

The following pages include mechanical, packaging, and orderable information. This information is the most-current data available for the designated devices. This data is subject to change without notice and without revision of this document. For browser-based versions of this data sheet, see the left-hand navigation pane.

**PACKAGING INFORMATION**

Orderable part number	Status (1)	Material type (2)	Package   Pins	Package qty   Carrier	RoHS (3)	Lead finish/ Ball material (4)	MSL rating/ Peak reflow (5)	Op temp (°C)	Part marking (6)
<a href="#">DAC6551AQDGKRQ1</a>	Active	Production	VSSOP (DGK)   8	2500   LARGE T&R	Yes	NIPDAUAG	Level-2-260C-1 YEAR	-40 to 125	D61Q
DAC6551AQDGKRQ1.A	Active	Production	VSSOP (DGK)   8	2500   LARGE T&R	Yes	NIPDAUAG	Level-2-260C-1 YEAR	-40 to 125	D61Q
DAC6551AQDGKRQ1.B	Active	Production	VSSOP (DGK)   8	2500   LARGE T&R	Yes	NIPDAUAG	Level-2-260C-1 YEAR	-40 to 125	D61Q
<a href="#">DAC8551AQDGKRQ1</a>	Active	Production	VSSOP (DGK)   8	2500   LARGE T&R	Yes	NIPDAU   NIPDAUAG	Level-2-260C-1 YEAR	-40 to 125	D81Q
DAC8551AQDGKRQ1.A	Active	Production	VSSOP (DGK)   8	2500   LARGE T&R	Yes	NIPDAUAG	Level-2-260C-1 YEAR	-40 to 125	D81Q
DAC8551AQDGKRQ1.B	Active	Production	VSSOP (DGK)   8	2500   LARGE T&R	Yes	NIPDAUAG	Level-2-260C-1 YEAR	-40 to 125	D81Q

<sup>(1)</sup> **Status:** For more details on status, see our [product life cycle](#).

<sup>(2)</sup> **Material type:** When designated, preproduction parts are prototypes/experimental devices, and are not yet approved or released for full production. Testing and final process, including without limitation quality assurance, reliability performance testing, and/or process qualification, may not yet be complete, and this item is subject to further changes or possible discontinuation. If available for ordering, purchases will be subject to an additional waiver at checkout, and are intended for early internal evaluation purposes only. These items are sold without warranties of any kind.

<sup>(3)</sup> **RoHS values:** Yes, No, RoHS Exempt. See the [TI RoHS Statement](#) for additional information and value definition.

<sup>(4)</sup> **Lead finish/Ball material:** Parts may have multiple material finish options. Finish options are separated by a vertical ruled line. Lead finish/Ball material values may wrap to two lines if the finish value exceeds the maximum column width.

<sup>(5)</sup> **MSL rating/Peak reflow:** The moisture sensitivity level ratings and peak solder (reflow) temperatures. In the event that a part has multiple moisture sensitivity ratings, only the lowest level per JEDEC standards is shown. Refer to the shipping label for the actual reflow temperature that will be used to mount the part to the printed circuit board.

<sup>(6)</sup> **Part marking:** There may be an additional marking, which relates to the logo, the lot trace code information, or the environmental category of the part.

Multiple part markings will be inside parentheses. Only one part marking contained in parentheses and separated by a "~" will appear on a part. If a line is indented then it is a continuation of the previous line and the two combined represent the entire part marking for that device.

**Important Information and Disclaimer:**The information provided on this page represents TI's knowledge and belief as of the date that it is provided. TI bases its knowledge and belief on information provided by third parties, and makes no representation or warranty as to the accuracy of such information. Efforts are underway to better integrate information from third parties. TI has taken and continues to take reasonable steps to provide representative and accurate information but may not have conducted destructive testing or chemical analysis on incoming materials and chemicals. TI and TI suppliers consider certain information to be proprietary, and thus CAS numbers and other limited information may not be available for release.

In no event shall TI's liability arising out of such information exceed the total purchase price of the TI part(s) at issue in this document sold by TI to Customer on an annual basis.

**OTHER QUALIFIED VERSIONS OF DAC8551-Q1 :**

- Catalog : [DAC8551](#)

## NOTE: Qualified Version Definitions:

- Catalog - TI's standard catalog product

## TAPE AND REEL INFORMATION

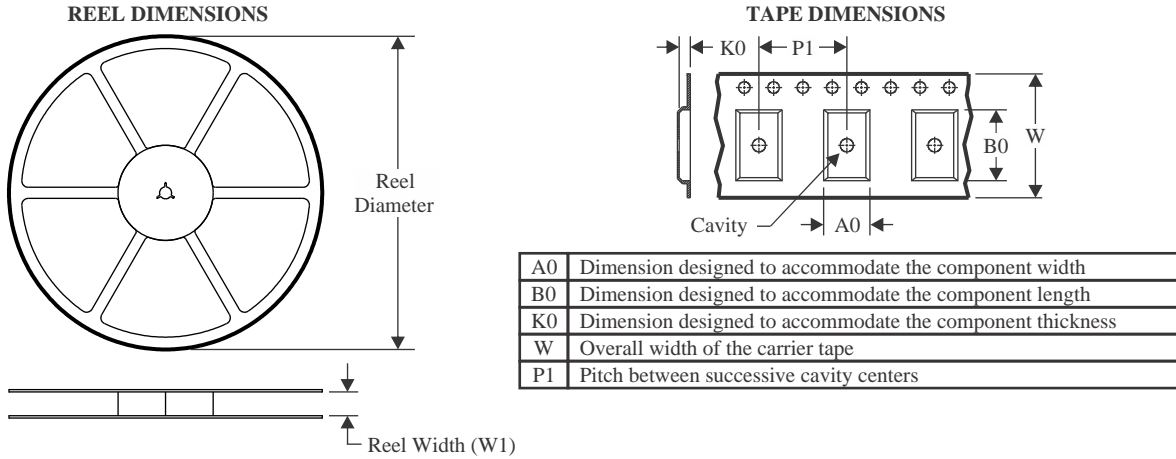

### QUADRANT ASSIGNMENTS FOR PIN 1 ORIENTATION IN TAPE

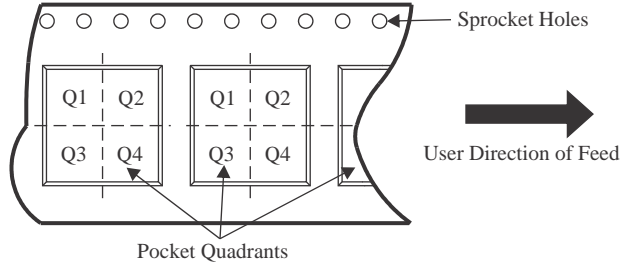

\*All dimensions are nominal

Device	Package Type	Package Drawing	Pins	SPQ	Reel Diameter (mm)	Reel Width W1 (mm)	A0 (mm)	B0 (mm)	K0 (mm)	P1 (mm)	W (mm)	Pin1 Quadrant
DAC6551AQDGKRQ1	VSSOP	DGK	8	2500	330.0	12.4	5.3	3.4	1.4	8.0	12.0	Q1
DAC8551AQDGKRQ1	VSSOP	DGK	8	2500	330.0	12.4	5.3	3.4	1.4	8.0	12.0	Q1

## TAPE AND REEL BOX DIMENSIONS



\*All dimensions are nominal

Device	Package Type	Package Drawing	Pins	SPQ	Length (mm)	Width (mm)	Height (mm)
DAC6551AQDGKRQ1	VSSOP	DGK	8	2500	350.0	350.0	43.0
DAC8551AQDGKRQ1	VSSOP	DGK	8	2500	353.0	353.0	32.0



# DGK0008A

# PACKAGE OUTLINE

VSSOP - 1.1 mm max height

SMALL OUTLINE PACKAGE

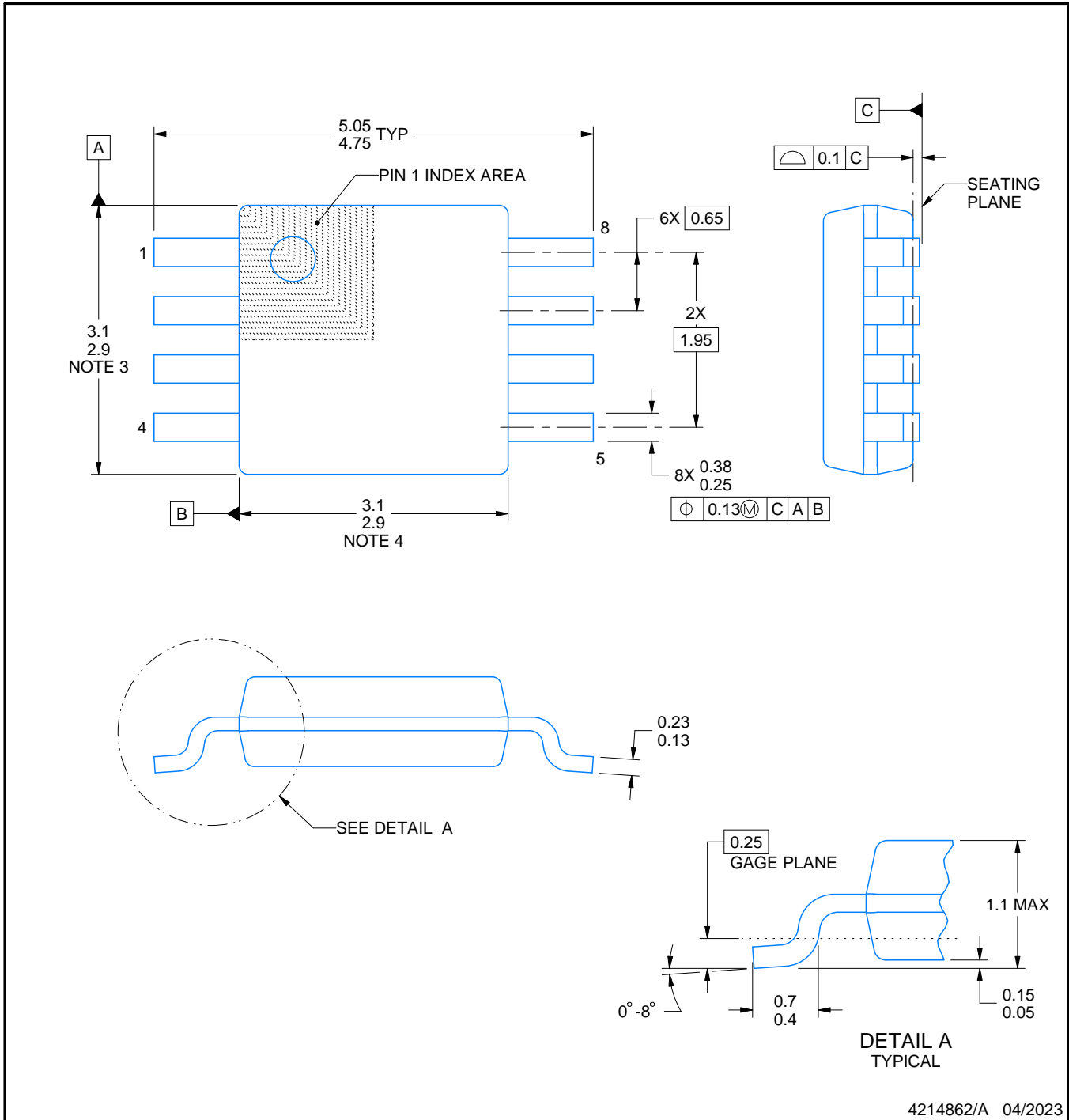

4214862/A 04/2023

**NOTES:**

PowerPAD is a trademark of Texas Instruments.

1. All linear dimensions are in millimeters. Any dimensions in parenthesis are for reference only. Dimensioning and tolerancing per ASME Y14.5M.
2. This drawing is subject to change without notice.
3. This dimension does not include mold flash, protrusions, or gate burrs. Mold flash, protrusions, or gate burrs shall not exceed 0.15 mm per side.
4. This dimension does not include interlead flash. Interlead flash shall not exceed 0.25 mm per side.
5. Reference JEDEC registration MO-187.

# EXAMPLE BOARD LAYOUT

DGK0008A

<sup>TM</sup> VSSOP - 1.1 mm max height

SMALL OUTLINE PACKAGE

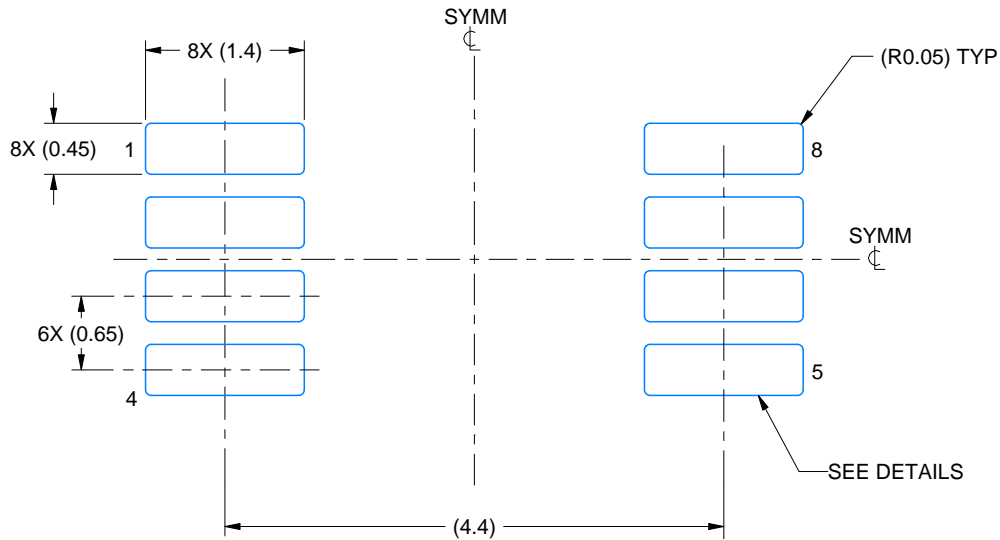

LAND PATTERN EXAMPLE  
EXPOSED METAL SHOWN  
SCALE: 15X

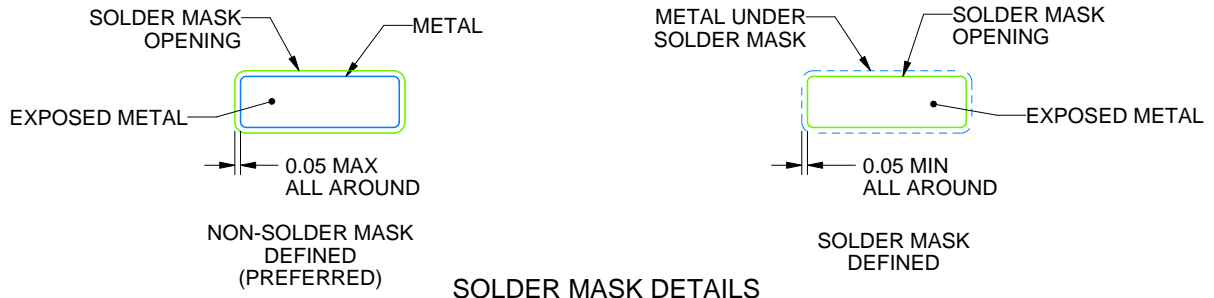

SOLDER MASK DETAILS

4214862/A 04/2023

NOTES: (continued)

6. Publication IPC-7351 may have alternate designs.
7. Solder mask tolerances between and around signal pads can vary based on board fabrication site.
8. Vias are optional depending on application, refer to device data sheet. If any vias are implemented, refer to their locations shown on this view. It is recommended that vias under paste be filled, plugged or tented.
9. Size of metal pad may vary due to creepage requirement.

# EXAMPLE STENCIL DESIGN

DGK0008A

<sup>TM</sup> VSSOP - 1.1 mm max height

SMALL OUTLINE PACKAGE

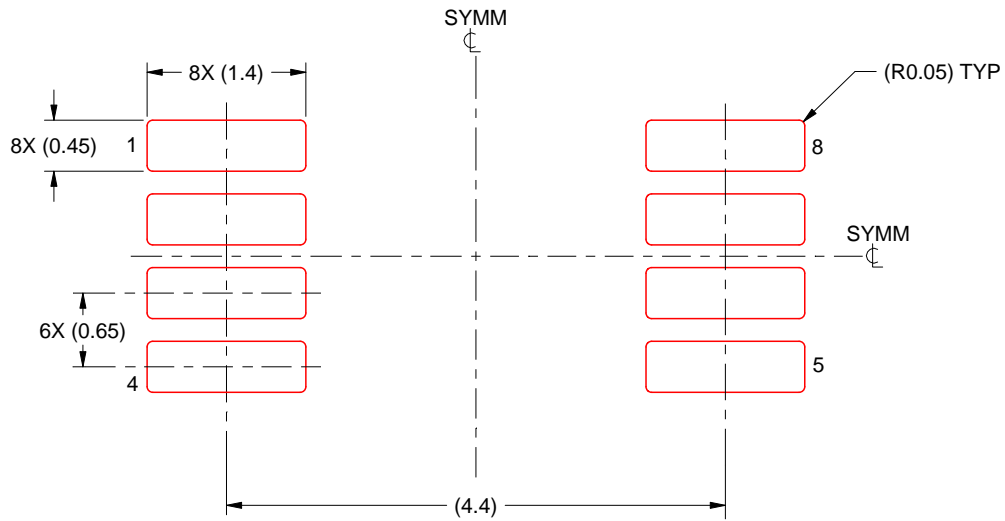

SOLDER PASTE EXAMPLE  
SCALE: 15X

4214862/A 04/2023

NOTES: (continued)

11. Laser cutting apertures with trapezoidal walls and rounded corners may offer better paste release. IPC-7525 may have alternate design recommendations.
12. Board assembly site may have different recommendations for stencil design.

## IMPORTANT NOTICE AND DISCLAIMER

TI PROVIDES TECHNICAL AND RELIABILITY DATA (INCLUDING DATASHEETS), DESIGN RESOURCES (INCLUDING REFERENCE DESIGNS), APPLICATION OR OTHER DESIGN ADVICE, WEB TOOLS, SAFETY INFORMATION, AND OTHER RESOURCES "AS IS" AND WITH ALL FAULTS, AND DISCLAIMS ALL WARRANTIES, EXPRESS AND IMPLIED, INCLUDING WITHOUT LIMITATION ANY IMPLIED WARRANTIES OF MERCHANTABILITY, FITNESS FOR A PARTICULAR PURPOSE OR NON-INFRINGEMENT OF THIRD PARTY INTELLECTUAL PROPERTY RIGHTS.

These resources are intended for skilled developers designing with TI products. You are solely responsible for (1) selecting the appropriate TI products for your application, (2) designing, validating and testing your application, and (3) ensuring your application meets applicable standards, and any other safety, security, regulatory or other requirements.

These resources are subject to change without notice. TI grants you permission to use these resources only for development of an application that uses the TI products described in the resource. Other reproduction and display of these resources is prohibited. No license is granted to any other TI intellectual property right or to any third party intellectual property right. TI disclaims responsibility for, and you fully indemnify TI and its representatives against any claims, damages, costs, losses, and liabilities arising out of your use of these resources.

TI's products are provided subject to [TI's Terms of Sale](#), [TI's General Quality Guidelines](#), or other applicable terms available either on [ti.com](http://ti.com) or provided in conjunction with such TI products. TI's provision of these resources does not expand or otherwise alter TI's applicable warranties or warranty disclaimers for TI products. Unless TI explicitly designates a product as custom or customer-specified, TI products are standard, catalog, general purpose devices.

TI objects to and rejects any additional or different terms you may propose.

Copyright © 2025, Texas Instruments Incorporated

Last updated 10/2025

## OUR CERTIFICATE

DiGi provide top-quality products and perfect service for customer worldwide through standardization, technological innovation and continuous improvement. DiGi through third-party certification, we strictly control the quality of products and services. Welcome your RFQ to

Email: [Info@DiGi-Electronics.com](mailto:Info@DiGi-Electronics.com)



Tel: +00 852-30501935

RFQ Email: [Info@DiGi-Electronics.com](mailto:Info@DiGi-Electronics.com)

DiGi is a global authorized distributor of electronic components.