

DAC8822QBDBTR Datasheet

www.digi-electronics.com

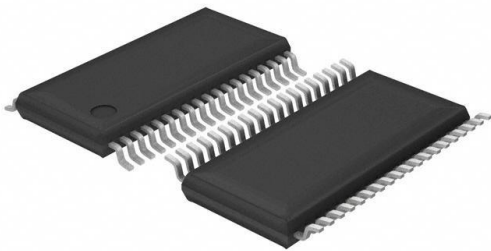

DAC8822QBDBTR

<https://www.DiGi-Electronics.com>

DiGi Electronics Part Number	DAC8822QBDBTR-DG
Manufacturer	Texas Instruments
Manufacturer Product Number	DAC8822QBDBTR
Description	IC DAC 16BIT A-OUT 38TSSOP
Detailed Description	16 Bit Digital to Analog Converter 2 38-TSSOP



Tel: +00 852-30501935

RFQ Email: Info@DiGi-Electronics.com

DiGi is a global authorized distributor of electronic components.

Purchase and inquiry

Manufacturer Product Number:

DAC8822QBDBTR

Series:

-

DiGi-Electronics Programmable:

Not Verified

Number of D/A Converters:

2

Output Type:

Current - Unbuffered

Data Interface:

Parallel

Voltage - Supply, Analog:

2.7V ~ 5.5V

INL/DNL (LSB):

±2 (Max), ±0.5

Operating Temperature:

-40°C ~ 125°C

Supplier Device Package:

38-TSSOP

Base Product Number:

DAC8822

Manufacturer:

Texas Instruments

Product Status:

Active

Number of Bits:

16

Settling Time:

500ns (Typ)

Differential Output:

No

Reference Type:

External

Voltage - Supply, Digital:

2.7V ~ 5.5V

Architecture:

Multiplying DAC

Package / Case:

38-TFSOP (0.173", 4.40mm Width)

Mounting Type:

Surface Mount

Environmental & Export classification

RoHS Status:

ROHS3 Compliant

REACH Status:

REACH Unaffected

HTSUS:

8542.39.0001

Moisture Sensitivity Level (MSL):

2 (1 Year)

ECCN:

EAR99



16-Bit, Dual, Parallel Input, Multiplying Digital-to-Analog Converter

FEATURES

- $\pm 0.5\text{LSB DNL}$
- $\pm 1\text{LSB INL}$
- **Low Noise:** $12\text{nV}/\sqrt{\text{Hz}}$
- **Low Power Operation:**
 $I_{\text{DD}} = 1\mu\text{A per Channel at } 2.7\text{V}$
- **2mA Full-Scale Current, with $V_{\text{REF}} = 10\text{V}$**
- **Settling Time:** $0.5\mu\text{s}$
- **16-Bit Monotonic**
- **4-Quadrant Multiplying Reference Inputs**
- **Reference Bandwidth:** 10MHz
- **Reference Input:** $\pm 18\text{V}$
- **Reference Dynamics:** -105 THD
- **Midscale or Zero Scale Reset**
- **Analog Power Supply:** $+2.7\text{V to } +5.5\text{V}$
- **TSSOP-38 Package**
- **Industry-Standard Pin Configuration**
- **Pin-Compatible with the 14-Bit [DAC8805](#)**
- **Temperature Range:** $-40^{\circ}\text{C to } +125^{\circ}\text{C}$

APPLICATIONS

- **Automatic Test Equipment**
- **Instrumentation**
- **Digitally Controlled Calibration**
- **Industrial Control PLCs**

DESCRIPTION

The DAC8822 dual, multiplying digital-to-analog converter (DAC) is designed to operate from a single 2.7V to 5.5V supply.

The applied external reference input voltage V_{REF} determines the full-scale output current. An internal feedback resistor (R_{FB}) provides temperature tracking for the full-scale output when combined with an external, current-to-voltage (I/V) precision amplifier.

A RSTSEL pin allows system reset assertion ($\overline{\text{RS}}$) to force all registers to zero code when $\text{RSTSEL} = '0'$, or to midscale code when $\text{RSTSEL} = '1'$. Additionally, an internal power-on reset forces all registers to zero or midscale code at power-up, depending on the state of the RSTSEL pin.

A parallel interface offers high-speed communications. The DAC8822 is packaged in a space-saving TSSOP-38 package and has an industry-standard pinout. The device is specified from -40°C to $+125^{\circ}\text{C}$.

For a 14-bit, pin-compatible version, see the [DAC8805](#).

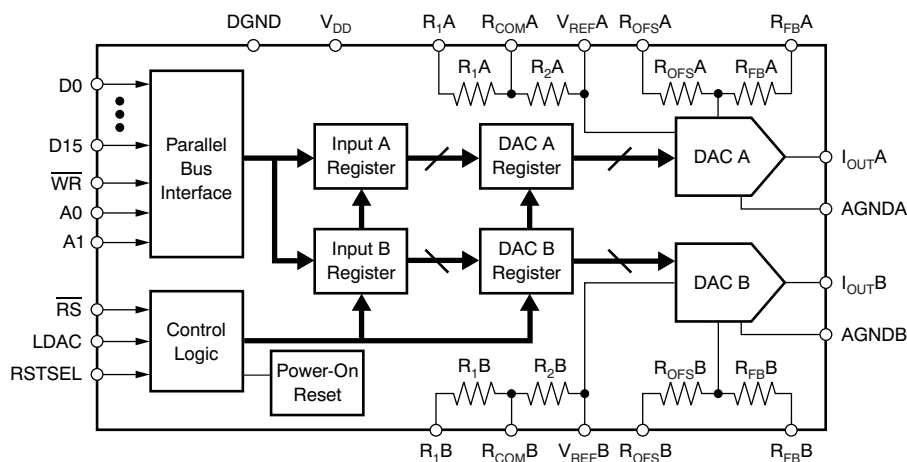

Please be aware that an important notice concerning availability, standard warranty, and use in critical applications of Texas Instruments semiconductor products and disclaimers thereto appears at the end of this data sheet.

All trademarks are the property of their respective owners.



This integrated circuit can be damaged by ESD. Texas Instruments recommends that all integrated circuits be handled with appropriate precautions. Failure to observe proper handling and installation procedures can cause damage.

ESD damage can range from subtle performance degradation to complete device failure. Precision integrated circuits may be more susceptible to damage because very small parametric changes could cause the device not to meet its published specifications.

ORDERING INFORMATION⁽¹⁾

PRODUCT	RELATIVE ACCURACY (LSB)	DIFFERENTIAL NONLINEARITY (LSB)	PACKAGE-LEAD (DESIGNATOR)	SPECIFIED TEMPERATURE RANGE	PACKAGE MARKING
DAC8822QB	±2	±1	TSSOP-38 (DBT)	–40°C to +125°C	DAC8822
DAC8822QC	±1	±1	TSSOP-38 (DBT)	–40°C to +125°C	DAC8822

(1) For the most current package and ordering information see the Package Option Addendum at the end of this document, or see the TI web site at www.ti.com.

ABSOLUTE MAXIMUM RATINGS

over operating free-air temperature range (unless otherwise noted)⁽¹⁾

	DAC8822	UNIT
V _{DD} to GND	–0.3 to +7	V
Digital input voltage to GND	–0.3 to +V _{DD} + 0.3	V
V (I _{OUT}) to GND	–0.3 to +V _{DD} + 0.3	V
REF, R _{OFS} , R _{FB} , R ₁ , R _{COM} to AGND, DGND	±25	V
Operating temperature range	–40 to +125	°C
Storage temperature range	–65 to +150	°C
Junction temperature range (T _J max)	+150	°C
Power dissipation	(T _J max – T _A) / R _{θJA}	W
Thermal impedance, R _{θJA}	53	°C/W
ESD rating	Human Body Model (HBM)	4000
	Charged Device Model (CDM)	500

(1) Stresses above those listed under *Absolute Maximum Ratings* may cause permanent damage to the device. Exposure to absolute maximum conditions for extended periods may affect device reliability.

ELECTRICAL CHARACTERISTICS

 All specifications at $T_A = -40^{\circ}\text{C}$ to $+125^{\circ}\text{C}$, $V_{DD} = +2.7\text{V}$ to $+5.5\text{V}$, $I_{OUT} = \text{virtual GND}$, $\text{GND} = 0\text{V}$, and $V_{REF} = 10\text{V}$, unless otherwise noted.

PARAMETER	CONDITIONS	DAC8822			UNITS		
		MIN	TYP	MAX			
STATIC PERFORMANCE							
Resolution		16			Bits		
Relative accuracy	INL	DAC8822QB			±2	LSB	
		DAC8822QC			±1	LSB	
Differential nonlinearity	DNL			±0.5	±1	LSB	
Output leakage current	Data = 0000h, $T_A = +25^{\circ}\text{C}$				10	nA	
Output leakage current	Data = 0000h, Full temperature range				20	nA	
Full-scale gain error	Unipolar, data = FFFFh			±1	±4	mV	
	Bipolar, data = FFFFh			±1	±4	mV	
Full-scale temperature coefficient				±1	±2	ppm/ $^{\circ}\text{C}$	
Bipolar zero error	$T_A = +25^{\circ}\text{C}$			±1	±3	mV	
	Full temperature range			±1	±3	mV	
Power-supply rejection ratio	PSRR $V_{DD} = 5\text{V} \pm 10\%$			±0.2	±1.0	LSB/V	
OUTPUT CHARACTERISTICS⁽¹⁾							
Output current					2	mA	
Output capacitance	Code dependent				50	pF	
REFERENCE INPUT							
Reference voltage range	V_{REF}			-18	18	V	
Input resistance (unipolar)	R_{REF}	4	5	6		k Ω	
Input capacitance					5	pF	
R_1, R_2		4	5	6		k Ω	
Feedback and offset resistance	R_{OFS}, R_{FB}	8	10	12		k Ω	
LOGIC INPUTS AND OUTPUT⁽¹⁾							
Input low voltage	V_{IL}	$V_{DD} = +2.7\text{V}$			0.6	V	
	V_{IL}	$V_{DD} = +5\text{V}$			0.8	V	
Input high voltage	V_{IH}	$V_{DD} = +2.7\text{V}$	2.1			V	
	V_{IH}	$V_{DD} = +5\text{V}$	2.4			V	
Input leakage current	I_{IL}				0.001	1	μA
Input capacitance	C_{IL}				8	pF	
POWER REQUIREMENTS							
Supply voltage	V_{DD}			2.7	5.5	V	
Supply current	I_{DD}	Normal operation, logic inputs = 0V		3	6	μA	
		$V_{DD} = +4.5\text{V}$ to $+5.5\text{V}$, $V_{IH} = V_{DD}$ and $V_{IL} = \text{GND}$		3	6	μA	
		$V_{DD} = +2.7\text{V}$ to $+3.6\text{V}$, $V_{IH} = V_{DD}$ and $V_{IL} = \text{GND}$		1	3	μA	
AC CHARACTERISTICS⁽¹⁾⁽²⁾							
Output current settling time	t_s	To 0.0015% of full-scale, data = 0000h to FFFFh to 0000h		0.5		μs	
Reference multiplying BW	BW - 3dB	$V_{REF} = 5V_{PP}$, data = FFFFh, 2-quadrant mode		10		MHz	
DAC glitch impulse		$V_{REF} = 0\text{V}$ to 10V , data = 7FFFh to 8000h to 7FFFh		5		nV-s	
Feedthrough error	V_{OUT}/V_{REF}	Data = 0000h, $V_{REF} = 100\text{kHz}$, $\pm 10V_{PP}$, 2-quadrant mode		-70		dB	
Crosstalk error	V_{OUT}/V_{REFB}	Data = 0000h, $V_{REFB} = 100mV_{RMS}$, $f = 100\text{kHz}$		-100		dB	
Digital feedthrough		LDAC = logic low, $V_{REF} = -10\text{V}$ to $+10\text{V}$ Any code change		1		nV-s	
Total harmonic distortion	THD	$V_{REF} = 6V_{RMS}$, data = FFFFh, $f = 1\text{kHz}$		-105		dB	
Output noise density	e_n	$f = 1\text{kHz}$, BW = 1Hz, 2-quadrant mode		12		nV/ $\sqrt{\text{Hz}}$	

(1) Specified by design and characterization; not production tested.

(2) All ac characteristic tests are performed in a closed-loop system using a THS4011 I-to-V converter amplifier.

PIN ASSIGNMENTS

**DBT PACKAGE
TSSOP-38
(TOP VIEW)**

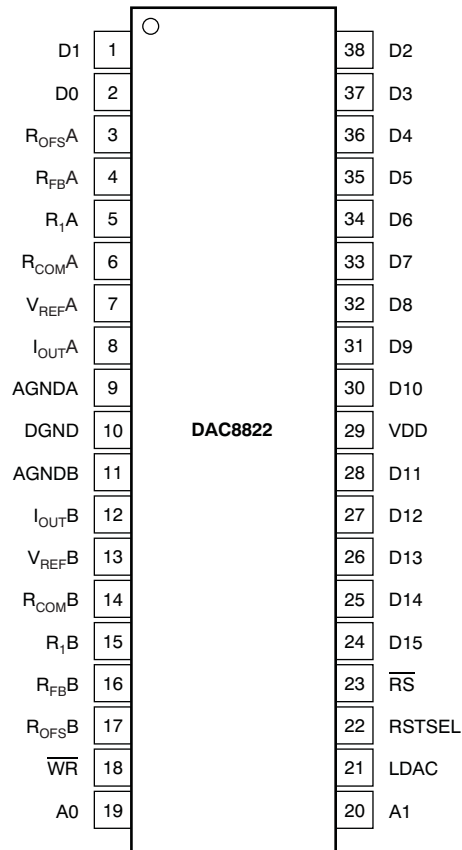

PIN ASSIGNMENTS (continued)

Table 1. TERMINAL FUNCTIONS

PIN #	NAME	DESCRIPTION
1, 2, 24-28, 30-38	D0-D15	Digital Input Data Bits D0 to D15. Signal level must be $\leq V_{DD} + 0.3V$. D15 is MSB.
3	R _{OFS} A	Bipolar Offset Resistor A. Accepts up to $\pm 18V$. In 2-quadrant mode, R _{OFS} A ties to R _{FB} A. In 4-quadrant mode, R _{OFS} A ties to R ₁ A and the external reference.
4	R _{FB} A	Internal Matching Feedback Resistor A. Connects to the external op amp for I-V conversion.
5	R ₁ A	4-Quadrant Resistor. In 2-quadrant mode, R ₁ A shorts to the V _{REF} A pin. In 4-quadrant mode, R ₁ A ties to R _{OFS} A and the reference input.
6	R _{COM} A	Center Tap Point of the Two 4-Quadrant Resistors, R ₁ A and R ₂ A. In 2-quadrant mode, R _{COM} A shorts to the V _{REF} pin. In 4-quadrant mode, R _{COM} A ties to the inverting node of the reference amplifier.
7	V _{REF} A	DAC A Reference Input in 2-Quadrant Mode, R ₂ Terminal in 4-Quadrant Mode. In 2-quadrant mode, V _{REF} A is the reference input with constant input resistance versus code. In 4-quadrant mode, V _{REF} A is driven by the external reference amplifier.
8	I _{OUT} A	DAC A Current Output. Connects to the inverting terminal of external precision I-V op amp for voltage output.
9	AGNDA	DAC A Analog Ground.
10	DGND	Digital Ground.
11	AGNDB	DAC B Analog Ground.
12	I _{OUT} B	DAC B Current Output. Connects to the inverting terminal of external precision I-V op amp for voltage output.
13	V _{REF} B	DAC B Reference Input in 2-Quadrant Mode, R ₂ Terminal in 4-Quadrant Mode. In 2-quadrant mode, V _{REF} B is the reference input with constant input resistance versus code. In 4-quadrant mode, V _{REF} B is driven by the external reference amplifier.
14	R _{COM} B	Center Tap Point of the Two 4-Quadrant Resistors, R ₁ B and R ₂ B. In 2-quadrant mode, R _{COM} B shorts to the V _{REF} pin. In 4-quadrant mode, R _{COM} B ties to the inverting node of the reference amplifier.
15	R ₁ B	4-Quadrant Resistor. In 2-quadrant mode, R ₁ B shorts to the V _{REF} B pin. In 4-quadrant mode, R ₁ B ties to R _{OFS} B and the reference input.
16	R _{FB} B	Internal Matching Feedback Resistor B. Connects to external op amp for I-V conversion.
17	R _{OFS} B	Bipolar Offset Resistor B. Accepts up to $\pm 18V$. In 2-quadrant mode, R _{OFS} B ties to R _{FB} B. In 4-quadrant mode, R _{OFS} B ties to R ₁ B and the external reference.
18	\overline{WR}	Write Control Digital Input In, Active Low. \overline{WR} enables input registers. Signal level must be $\leq V_{DD} + 0.3V$.
19	A0	Address 0. Signal level must be $\leq V_{DD} + 0.3V$.
20	A1	Address 1. Signal level must be $\leq V_{DD} + 0.3V$.
21	LDAC	Digital Input Load DAC Control. Signal level must be $\leq V_{DD} + 0.3V$. See the Function of Control Inputs table for details.
22	RSTSEL	Power-On Reset State. RSTSEL = 0 corresponds to zero-scale reset. RSTSEL = 1 corresponds to midscale reset. The signal level must be $\leq V_{DD} + 0.3V$.
23	\overline{RS}	Reset. Active low resets both input and DAC registers. Resets to zero-scale if RSTSEL= 0, and to midscale if RSTSEL = 1. Signal level must be equal to or less than VDD + 0.3 V.
29	V _{DD}	Positive Power Supply Input. The specified range of operation is 2.7V to 5.5V.

TIMING AND FUNCTIONAL INFORMATION

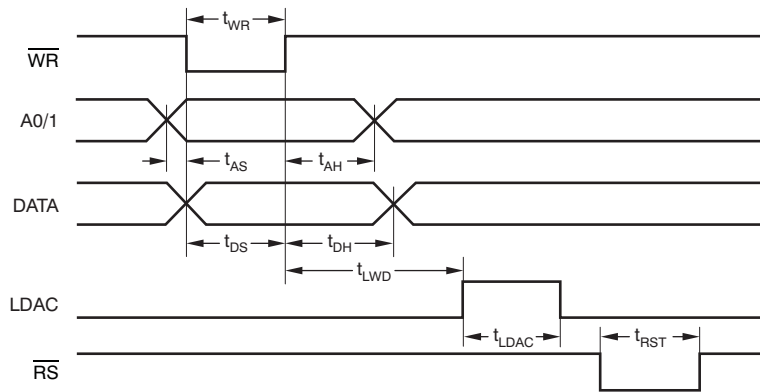

Figure 1. Timing Diagram

TIMING CHARACTERISTICS



All specifications at $T_A = -40^\circ\text{C}$ to $+125^\circ\text{C}$, $I_{OUT} = \text{virtual GND}$, $\text{GND} = 0\text{V}$, and $V_{REF} = 10\text{V}$, unless otherwise noted

PARAMETER	CONDITIONS	DAC8822			UNITS
		MIN	TYP	MAX	
Data to \overline{WR} setup time	$V_{DD} = +5.0\text{V}$	10			ns
	$V_{DD} = +2.7\text{V}$	10			ns
A0/1 to \overline{WR} setup time	$V_{DD} = +5.0\text{V}$	10			ns
	$V_{DD} = +2.7\text{V}$	10			ns
Data to \overline{WR} hold time	$V_{DD} = +5.0\text{V}$	0			ns
	$V_{DD} = +2.7\text{V}$	0			ns
A0/1 to \overline{WR} hold time	$V_{DD} = +5.0\text{V}$	0			ns
	$V_{DD} = +2.7\text{V}$	0			ns
\overline{WR} pulse width	$V_{DD} = +5.0\text{V}$	10			ns
	$V_{DD} = +2.7\text{V}$	10			ns
LDAC pulse width	$V_{DD} = +5.0\text{V}$	10			ns
	$V_{DD} = +2.7\text{V}$	10			ns
\overline{RS} pulse width	$V_{DD} = +5.0\text{V}$	10			ns
	$V_{DD} = +2.7\text{V}$	10			ns
\overline{WR} to LDAC delay time	$V_{DD} = +5.0\text{V}$	0			ns
	$V_{DD} = +2.7\text{V}$	0			ns

Table 2. Address Decoder Pins

A1	A0	OUTPUT UPDATE
0	0	DAC A
0	1	None
1	0	DAC A and DAC B
1	1	DAC B

Table 3. Function of Control Inputs

CONTROL INPUTS			REGISTER OPERATION
\overline{RS}	\overline{WR}	LDAC	
0	X	X	Asynchronous operation. Reset the input and DAC register to '0' when the RSTSEL pin is tied to DGND, and to midscale when RSTSEL is tied to V_{DD} .
1	0	0	Load the input register with all 16 data bits.
1	1	1	Load the DAC register with the contents of the input register.
1	0	1	The input and DAC register are transparent.
1			LDAC and \overline{WR} are tied together and programmed as a pulse. The 16 data bits are loaded into the input register on the falling edge of the pulse and then loaded into the DAC register on the rising edge of the pulse.
1	1	0	No register operation.

TYPICAL CHARACTERISTICS: $V_{DD} = +5V$

Channel A

LINEARITY ERROR vs DIGITAL INPUT CODE

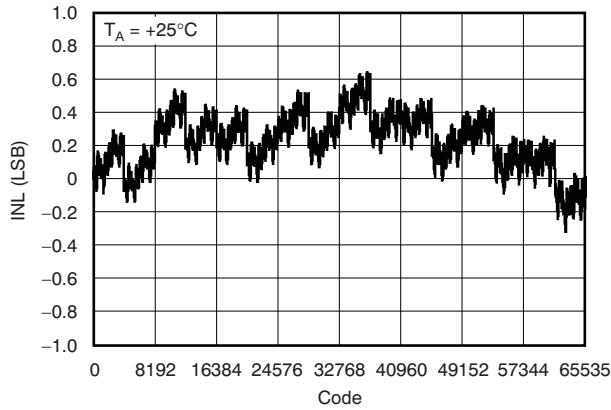

Figure 2.

DIFFERENTIAL LINEARITY ERROR vs DIGITAL INPUT CODE

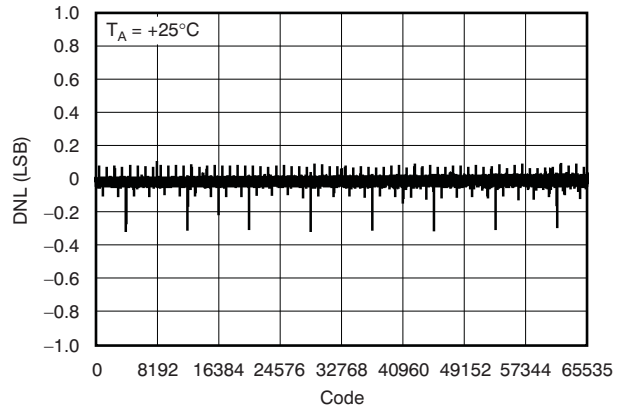

Figure 3.

LINEARITY ERROR vs DIGITAL INPUT CODE

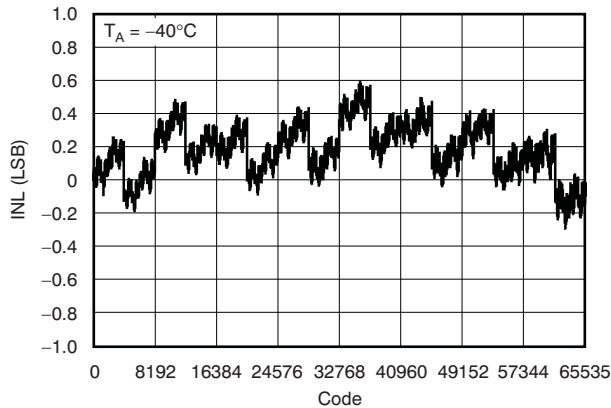

Figure 4.

DIFFERENTIAL LINEARITY ERROR vs DIGITAL INPUT CODE

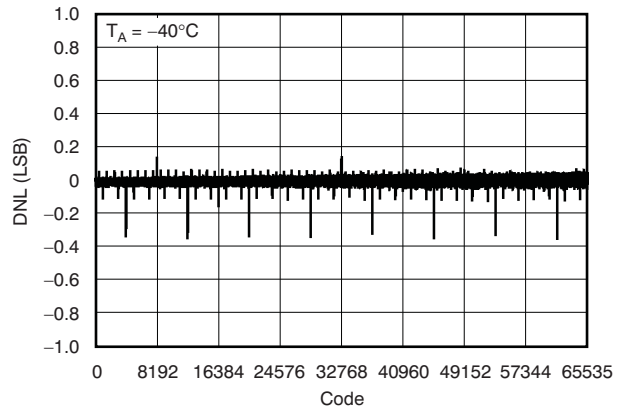

Figure 5.

LINEARITY ERROR vs DIGITAL INPUT CODE

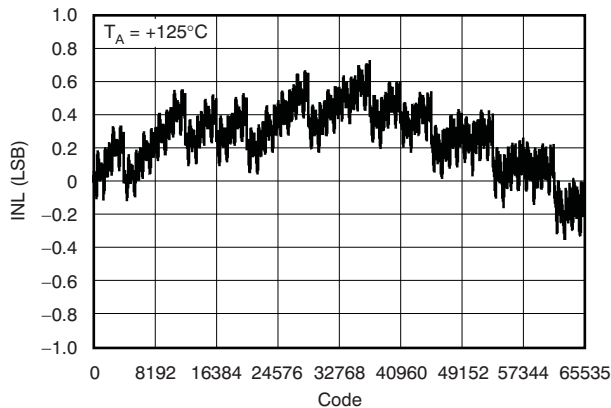

Figure 6.

DIFFERENTIAL LINEARITY ERROR vs DIGITAL INPUT CODE

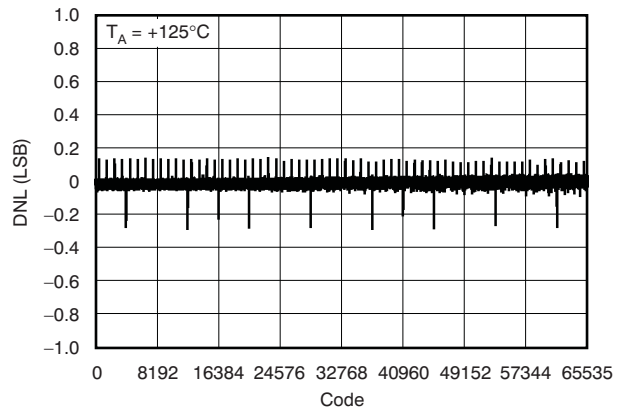

Figure 7.

TYPICAL CHARACTERISTICS: $V_{DD} = +5V$ (continued)

Channel B

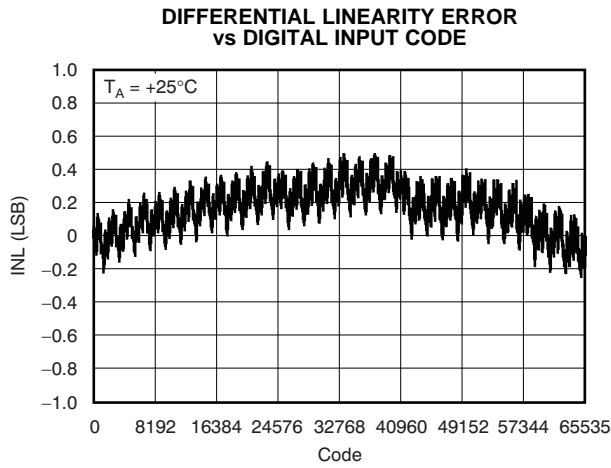

Figure 8.

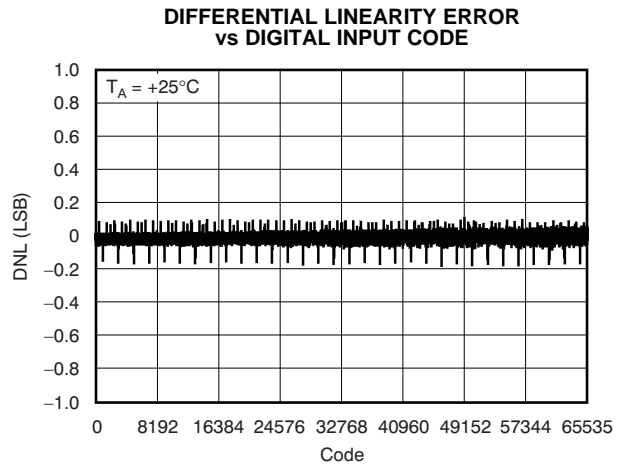

Figure 9.

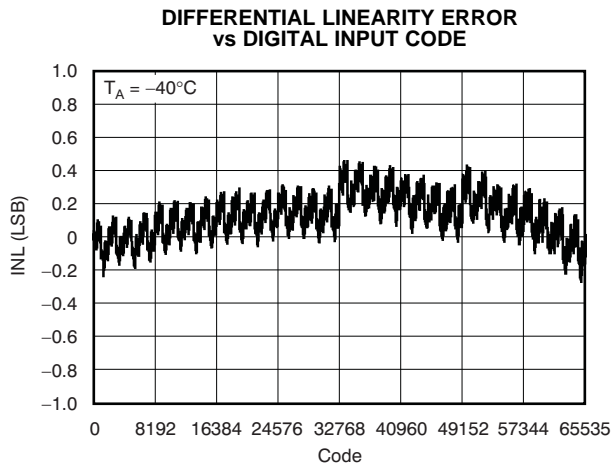

Figure 10.

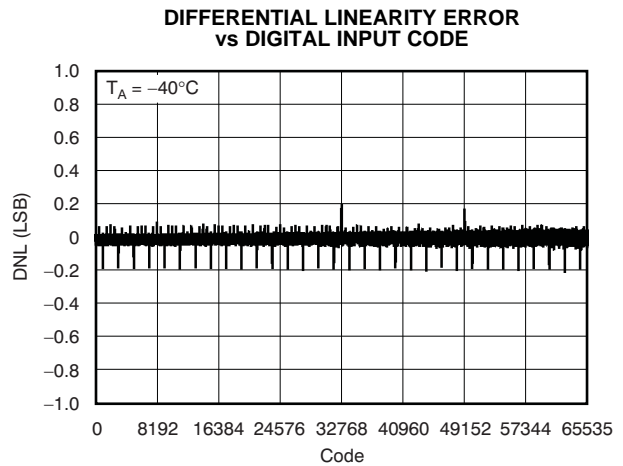

Figure 11.

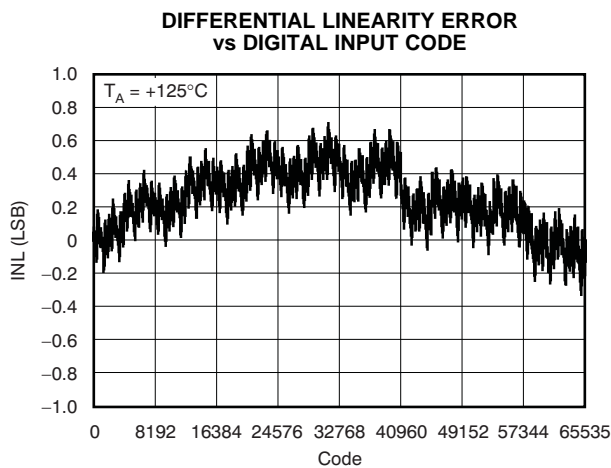

Figure 12.

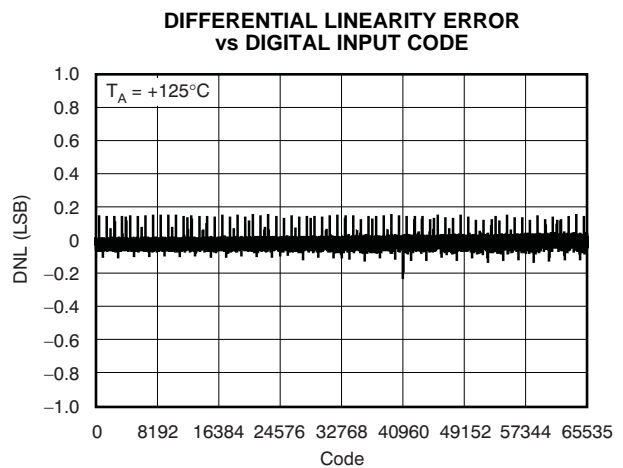

Figure 13.

TYPICAL CHARACTERISTICS: $V_{DD} = +5V$ (continued)

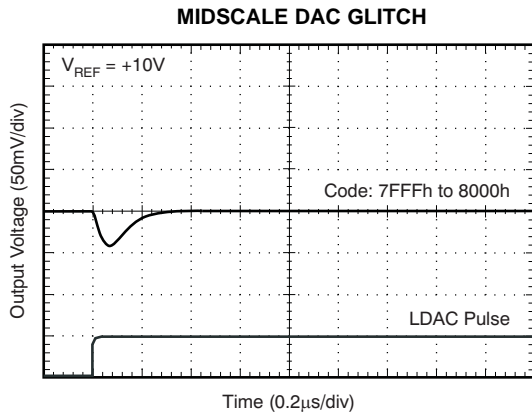

Figure 14.

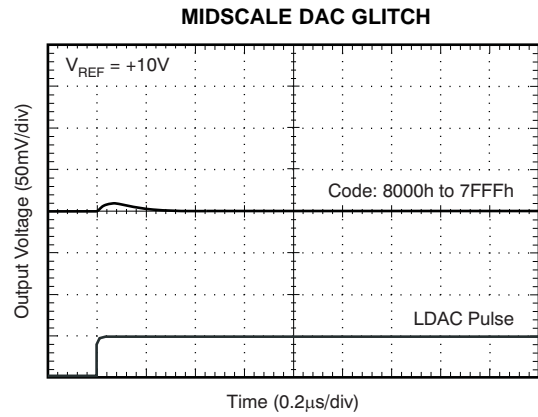

Figure 15.

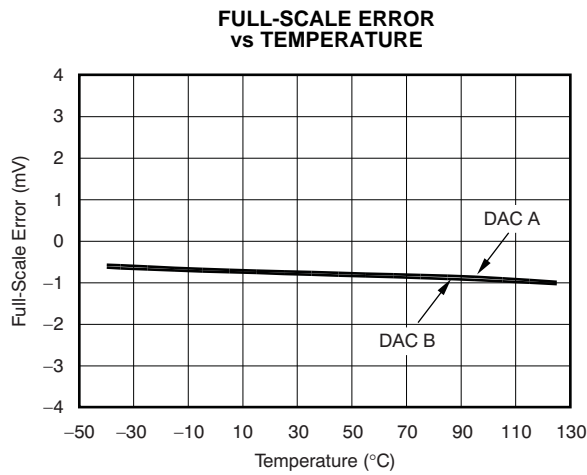

Figure 16.

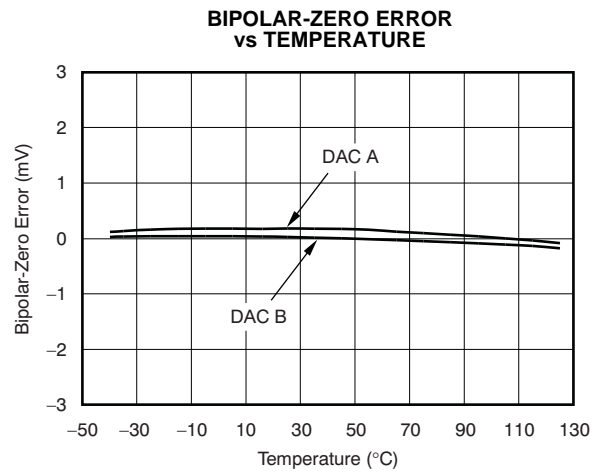

Figure 17.

TYPICAL CHARACTERISTICS: $V_{DD} = +2.7V$

Channel A

**LINEARITY ERROR
vs DIGITAL INPUT CODE**

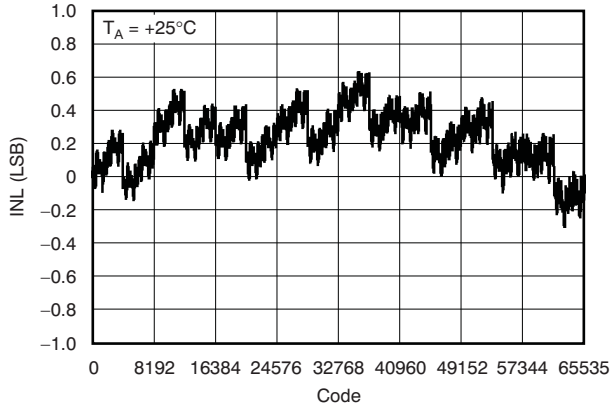

Figure 18.

**LINEARITY ERROR
vs DIGITAL INPUT CODE**

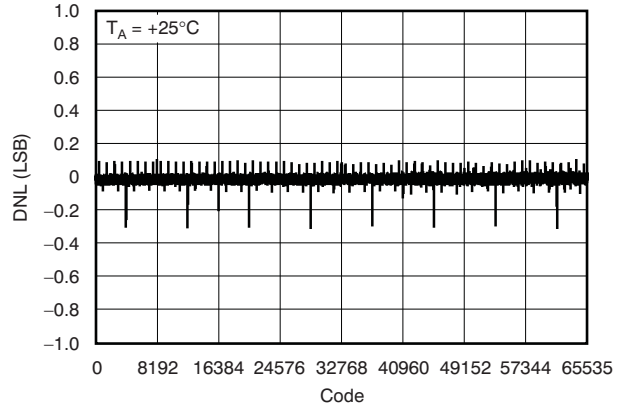

Figure 19.

**LINEARITY ERROR
vs DIGITAL INPUT CODE**

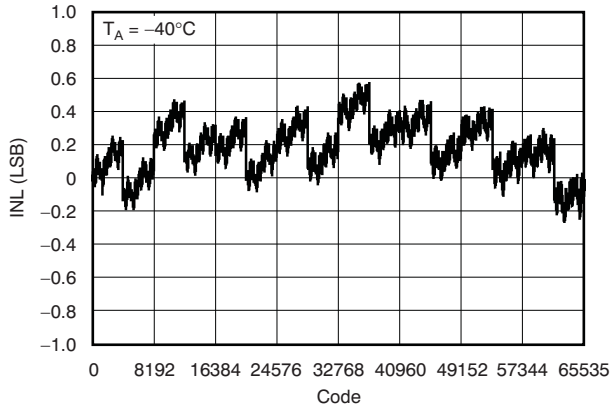

Figure 20.

**LINEARITY ERROR
vs DIGITAL INPUT CODE**

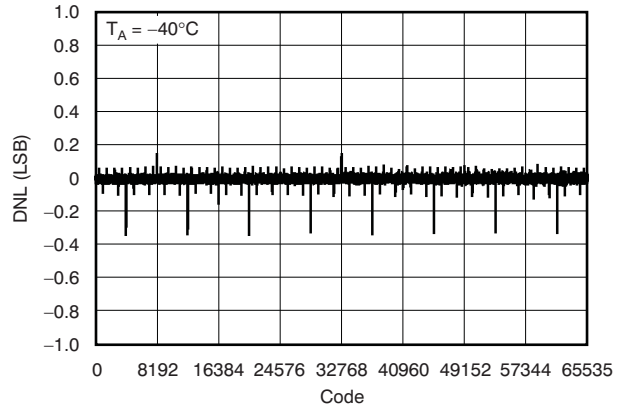

Figure 21.

**LINEARITY ERROR
vs DIGITAL INPUT CODE**

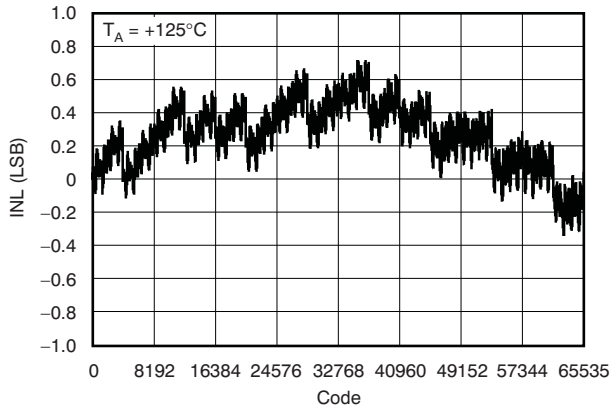

Figure 22.

**LINEARITY ERROR
vs DIGITAL INPUT CODE**

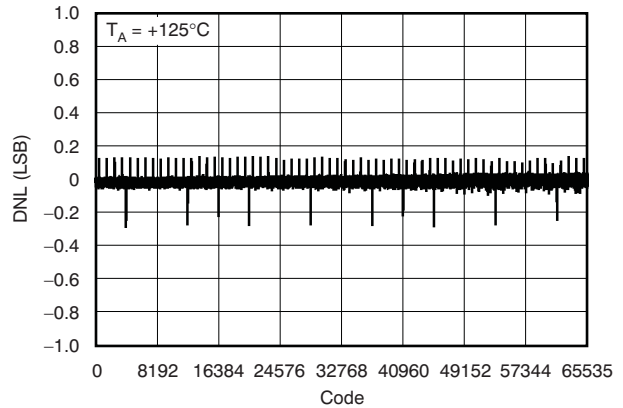

Figure 23.

TYPICAL CHARACTERISTICS: $V_{DD} = +2.7V$ (continued)

Channel B

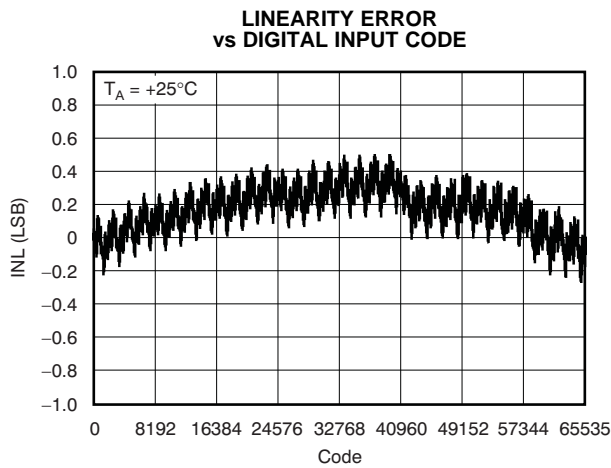

Figure 24.

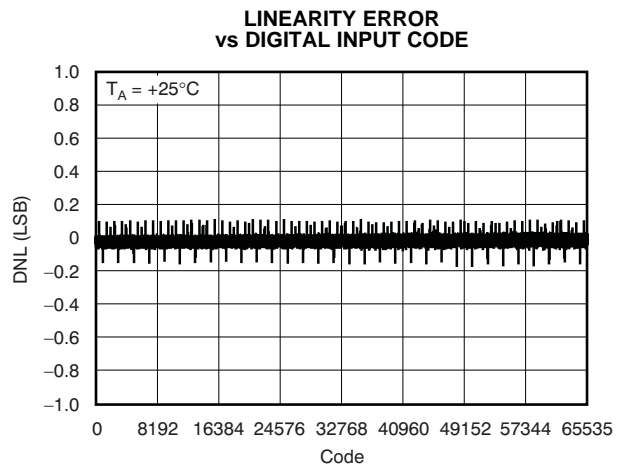

Figure 25.

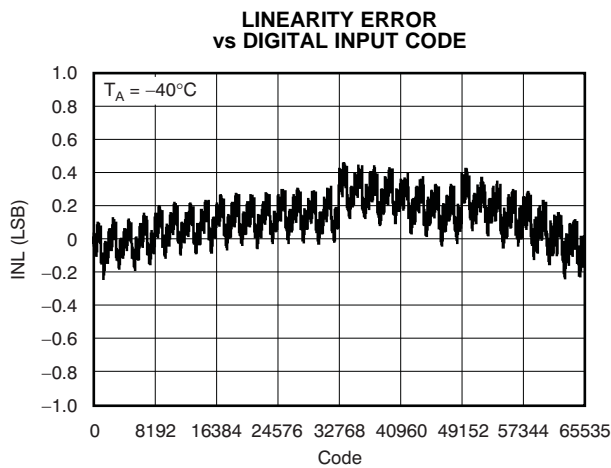

Figure 26.

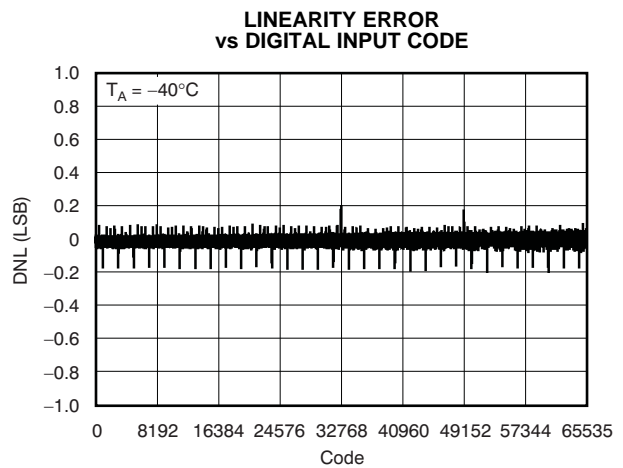

Figure 27.

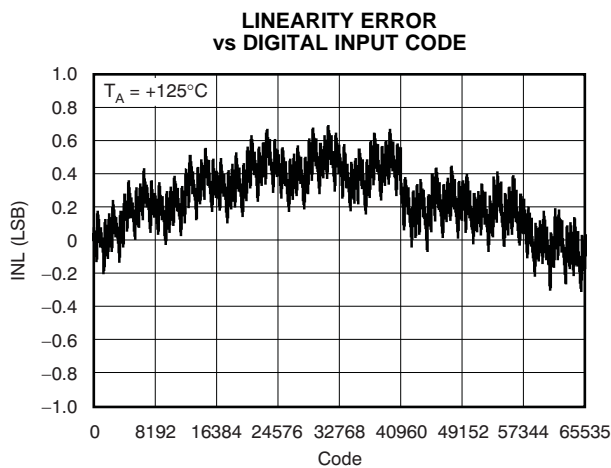

Figure 28.

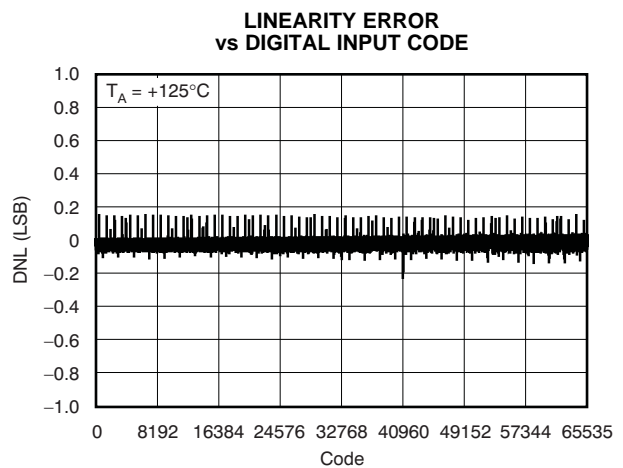

Figure 29.

TYPICAL CHARACTERISTICS: $V_{DD} = +2.7V$ (continued)

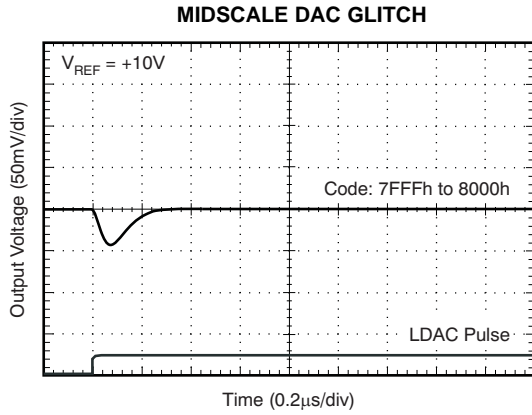

Figure 30.

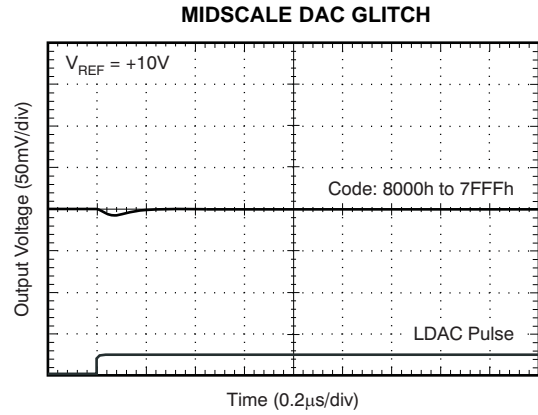

Figure 31.

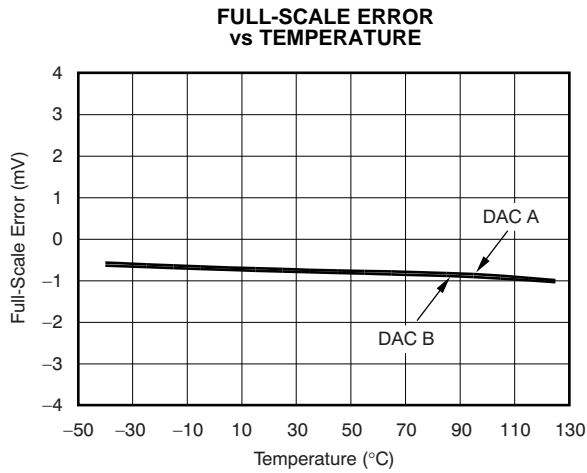

Figure 32.

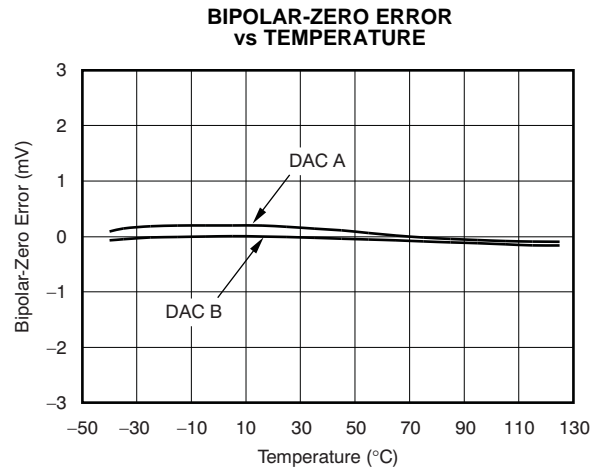

Figure 33.

TYPICAL CHARACTERISTICS: $V_{DD} = +2.7V$ and $+5V$

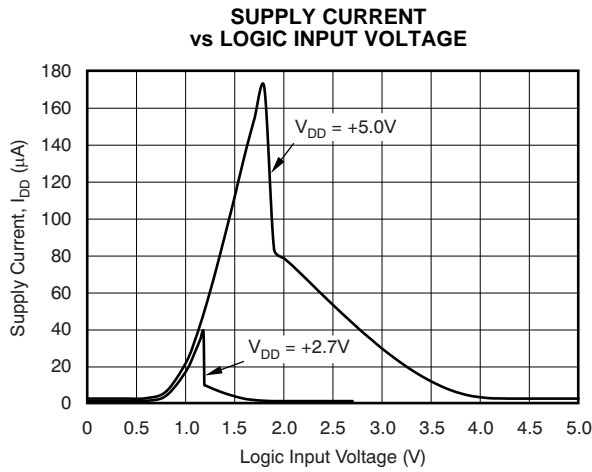

Figure 34.

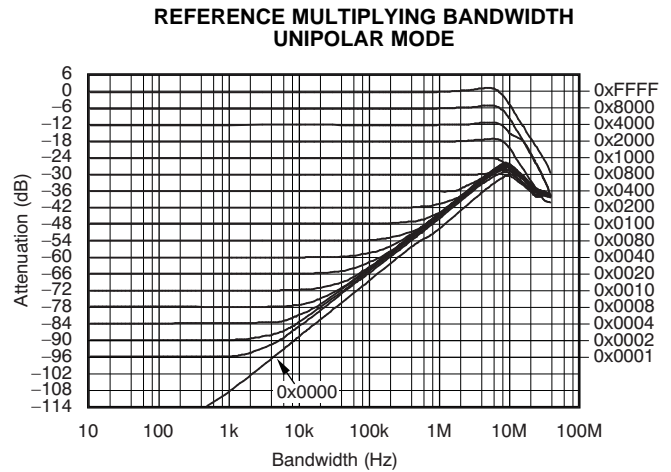

Figure 35.

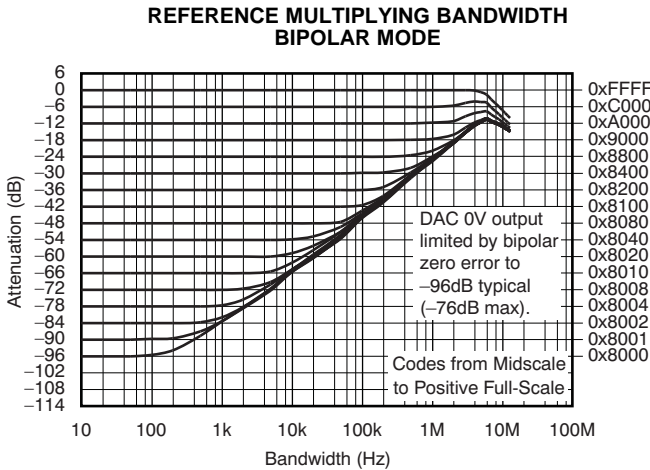

Figure 36.

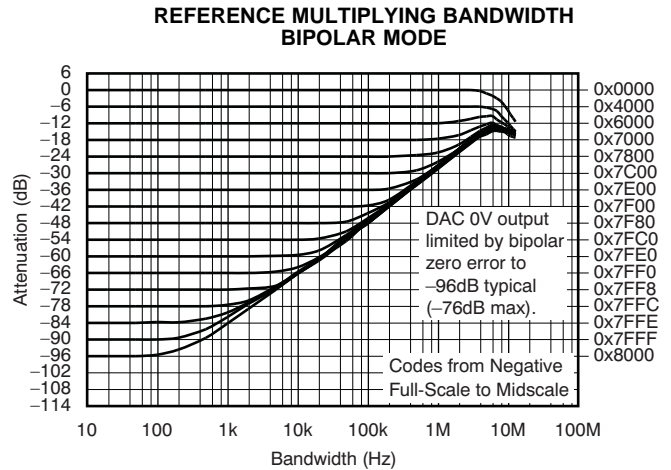

Figure 37.

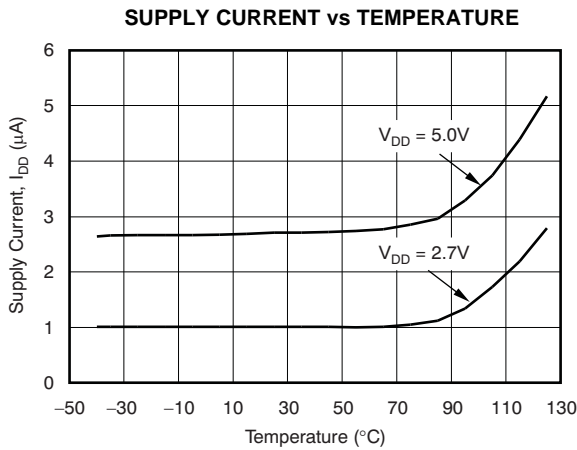

Figure 38.

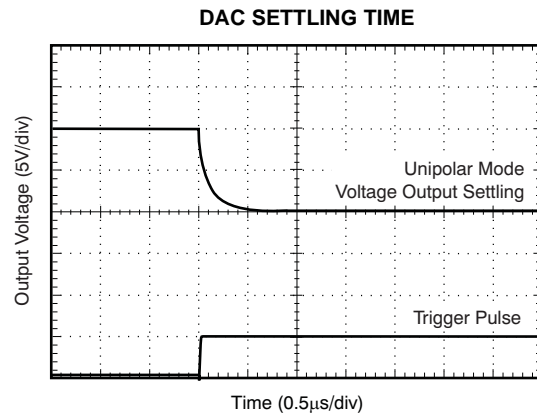

Figure 39.

THEORY OF OPERATION

The DAC8822 is a multiplying, dual-channel, current output, 16-bit DAC. The architecture, illustrated in Figure 40, is an R-2R ladder configuration with the three MSBs segmented. Each 2R leg of the ladder is either switched to GND or to the I_{OUT} terminal. The I_{OUT} terminal of the DAC is held at a virtual GND potential by the use of an external I/V converter op amp. The R-2R ladder is connected to an external reference input (V_{REF}) that determines the DAC full-scale output current. The R-2R ladder presents a code-independent load impedance to the external reference of $5k\Omega \pm 25\%$. The external reference voltage can vary in a range of $-18V$ to $+18V$, thus providing bipolar I_{OUT} current operation. By using an external I/V converter op amp and the R_{FB} resistor in the DAC8822, an output voltage range of $-V_{REF}$ to $+V_{REF}$ can be generated.

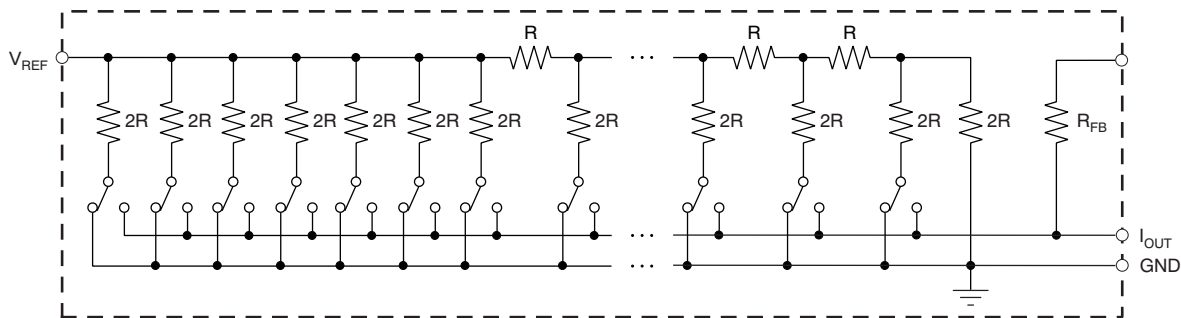

Figure 40. Equivalent R-2R DAC Circuit

The DAC output voltage is determined by V_{REF} and the digital data (D) according to Equation 1:

$$V_{OUT\ A/B} = -V_{REF} \times \frac{D}{65536} \quad (1)$$

Each DAC code determines the 2R-leg switch position to either GND or I_{OUT} . The external I/V converter op amp noise gain will also change because the DAC output impedance (as seen looking into the I_{OUT} terminal) changes versus code. Because of this change in noise gain, the external I/V converter op amp must have a sufficiently low offset voltage such that the amplifier offset is not modulated by the DAC I_{OUT} terminal impedance change. External op amps with large offset voltages can produce INL errors in the transfer function of the DAC8822 because of offset modulation versus DAC code. For best linearity performance of the DAC8822, an op amp (such as the OPA277) is recommended, as shown in Figure 41. This circuit allows V_{REF} to swing from $-10V$ to $+10V$.

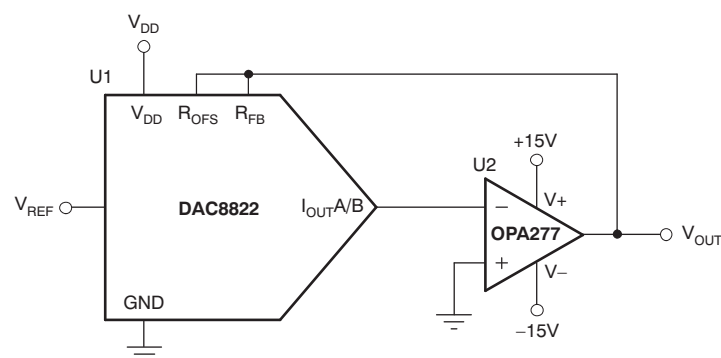

Figure 41. Voltage Output Configuration

APPLICATION INFORMATION

DIGITAL INTERFACE

The parallel bus interface of the DAC8822 is comprised of a 16-bit data bus D0—D15, address lines A0 and A1, and a \overline{WR} control signal. Timing and control functionality are shown in [Figure 1](#), and described in [Table 2](#) and [Table 3](#). The address lines must be set up and stable before the \overline{WR} signal goes low, to prevent loading improper data to an undesired input register.

Both channels of the DAC8822 can be simultaneously updated by control of the LDAC signal, as shown in [Figure 1](#). Reset control (\overline{RS}) and reset select control (RSTSEL) signals are provided to allow user reset ability to either zero scale or midscale codes of both the input and DAC registers.

STABILITY CIRCUIT

For a current-to-voltage (I/V) design, as shown in [Figure 42](#), the DAC8822 current output (I_{OUT}) and the connection with the inverting node of the op amp should be as short as possible and laid out according to correct printed circuit board (PCB) layout design. For each code change, there is an output step function. If the gain bandwidth product (GBP) of the op amp is limited and parasitic capacitance is excessive at the inverting node, then gain peaking is possible. Therefore, a compensation capacitor C_1 (4pF to 20pF, typ) can be added to the design for circuit stability, as shown in [Figure 42](#).

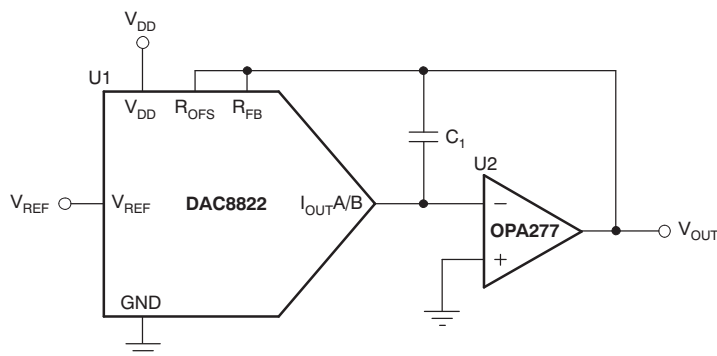

Figure 42. Gain Peaking Prevention Circuit with Compensation Capacitor

APPLICATION INFORMATION (continued)

PROGRAMMABLE CURRENT SOURCE CIRCUIT

The DAC8822 can be integrated into the circuit in [Figure 44](#) to implement an improved Howland current pump for precise V/I conversions. Bidirectional current flow and high-voltage compliance are two features of the circuit. With a matched resistor network, the load current of the circuit is shown by [Equation 3](#):

$$I_{L\ A/B} = \frac{(R_2 + R_3) / R_1}{R_3} \times V_{REF} \times \frac{D}{65536} \tag{3}$$

The value of R_3 in the previous equation can be reduced to increase the output current drive of U3. U3 can drive $\pm 20\text{mA}$ in both directions with voltage compliance limited up to 15V by the U3 voltage supply. Elimination of the circuit compensation capacitor (C_1) in the circuit is not suggested as a result of the change in the output impedance (Z_O), according to [Equation 4](#):

$$Z_O = \frac{R_1' R_3 (R_1 + R_2)}{R_1 (R_2' + R_3') - R_1' (R_2 + R_3)} \tag{4}$$

As shown in [Equation 4](#), Z_O with matched resistors is infinite and the circuit is optimum for use as a current source. However, if unmatched resistors are used, Z_O is positive or negative with negative output impedance being a potential cause of oscillation. Therefore, by incorporating C_1 into the circuit, possible oscillation problems are eliminated. The value of C_1 can be determined for critical applications; for most applications, however, a value of several pF is suggested.

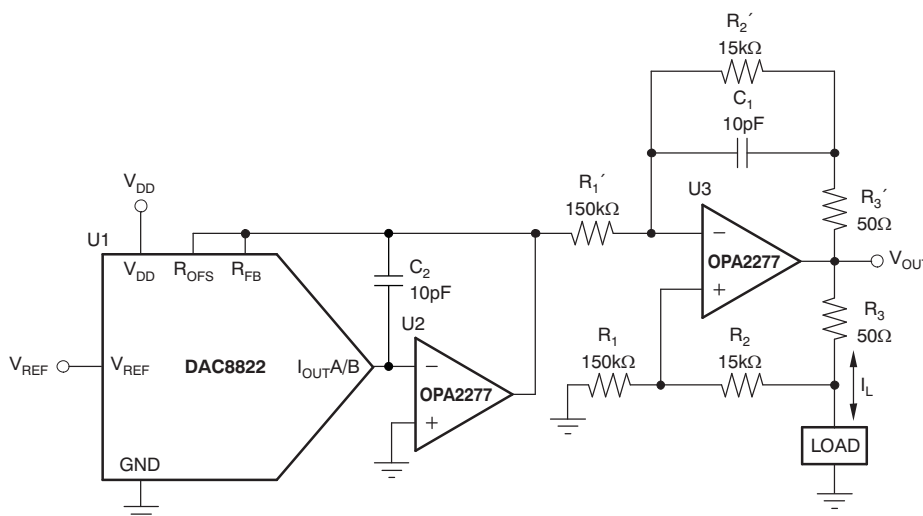

Figure 44. Programmable Bidirectional Current Source Circuit

CROSS-REFERENCE

The DAC8822 has an industry-standard pinout. [Table 4](#) provides the cross-reference information.

Table 4. Cross-Reference

PRODUCT	BIT	INL (LSB)	DNL (LSB)	SPECIFIED TEMPERATURE RANGE	PACKAGE DESCRIPTION	PACKAGE OPTION	CROSS-REFERENCE PART
DAC8822QB	16	2	1	-40°C to +125°C	TSSOP-38	DBT	AD5547B
DAC8822QC	16	1	1	-40°C to +125°C	TSSOP-38	DBT	N/A

PACKAGING INFORMATION

Orderable part number	Status (1)	Material type (2)	Package Pins	Package qty Carrier	RoHS (3)	Lead finish/ Ball material (4)	MSL rating/ Peak reflow (5)	Op temp (°C)	Part marking (6)
DAC8822QBDBT	Active	Production	TSSOP (DBT) 38	50 TUBE	Yes	NIPDAU	Level-2-260C-1 YEAR	-40 to 125	DAC8822
DAC8822QBDBT.A	Active	Production	TSSOP (DBT) 38	50 TUBE	Yes	NIPDAU	Level-2-260C-1 YEAR	-40 to 125	DAC8822
DAC8822QBDBTG4	Active	Production	TSSOP (DBT) 38	50 TUBE	Yes	NIPDAU	Level-2-260C-1 YEAR	-40 to 125	DAC8822
DAC8822QBDBTG4.A	Active	Production	TSSOP (DBT) 38	50 TUBE	Yes	NIPDAU	Level-2-260C-1 YEAR	-40 to 125	DAC8822
DAC8822QBDBTR	Active	Production	TSSOP (DBT) 38	2000 LARGE T&R	Yes	NIPDAU	Level-2-260C-1 YEAR	-40 to 125	DAC8822
DAC8822QBDBTR.A	Active	Production	TSSOP (DBT) 38	2000 LARGE T&R	Yes	NIPDAU	Level-2-260C-1 YEAR	-40 to 125	DAC8822
DAC8822QCDBT	Active	Production	TSSOP (DBT) 38	50 TUBE	Yes	NIPDAU	Level-2-260C-1 YEAR	-40 to 125	DAC8822
DAC8822QCDBT.A	Active	Production	TSSOP (DBT) 38	50 TUBE	Yes	NIPDAU	Level-2-260C-1 YEAR	-40 to 125	DAC8822
DAC8822QCDBTG4	Active	Production	TSSOP (DBT) 38	50 TUBE	Yes	NIPDAU	Level-2-260C-1 YEAR	-40 to 125	DAC8822
DAC8822QCDBTR	Active	Production	TSSOP (DBT) 38	2000 LARGE T&R	Yes	NIPDAU	Level-2-260C-1 YEAR	-40 to 125	DAC8822
DAC8822QCDBTR.A	Active	Production	TSSOP (DBT) 38	2000 LARGE T&R	Yes	NIPDAU	Level-2-260C-1 YEAR	-40 to 125	DAC8822
DAC8822QCDBTRG4	Active	Production	TSSOP (DBT) 38	2000 LARGE T&R	Yes	NIPDAU	Level-2-260C-1 YEAR	-40 to 125	DAC8822
DAC8822QCDBTRG4.A	Active	Production	TSSOP (DBT) 38	2000 LARGE T&R	Yes	NIPDAU	Level-2-260C-1 YEAR	-40 to 125	DAC8822

(1) **Status:** For more details on status, see our [product life cycle](#).

(2) **Material type:** When designated, preproduction parts are prototypes/experimental devices, and are not yet approved or released for full production. Testing and final process, including without limitation quality assurance, reliability performance testing, and/or process qualification, may not yet be complete, and this item is subject to further changes or possible discontinuation. If available for ordering, purchases will be subject to an additional waiver at checkout, and are intended for early internal evaluation purposes only. These items are sold without warranties of any kind.

(3) **RoHS values:** Yes, No, RoHS Exempt. See the [TI RoHS Statement](#) for additional information and value definition.

(4) **Lead finish/Ball material:** Parts may have multiple material finish options. Finish options are separated by a vertical ruled line. Lead finish/Ball material values may wrap to two lines if the finish value exceeds the maximum column width.

(5) **MSL rating/Peak reflow:** The moisture sensitivity level ratings and peak solder (reflow) temperatures. In the event that a part has multiple moisture sensitivity ratings, only the lowest level per JEDEC standards is shown. Refer to the shipping label for the actual reflow temperature that will be used to mount the part to the printed circuit board.

(6) **Part marking:** There may be an additional marking, which relates to the logo, the lot trace code information, or the environmental category of the part.

Multiple part markings will be inside parentheses. Only one part marking contained in parentheses and separated by a "~" will appear on a part. If a line is indented then it is a continuation of the previous line and the two combined represent the entire part marking for that device.

Important Information and Disclaimer: The information provided on this page represents TI's knowledge and belief as of the date that it is provided. TI bases its knowledge and belief on information provided by third parties, and makes no representation or warranty as to the accuracy of such information. Efforts are underway to better integrate information from third parties. TI has taken and continues to take reasonable steps to provide representative and accurate information but may not have conducted destructive testing or chemical analysis on incoming materials and chemicals. TI and TI suppliers consider certain information to be proprietary, and thus CAS numbers and other limited information may not be available for release.

In no event shall TI's liability arising out of such information exceed the total purchase price of the TI part(s) at issue in this document sold by TI to Customer on an annual basis.

TAPE AND REEL INFORMATION

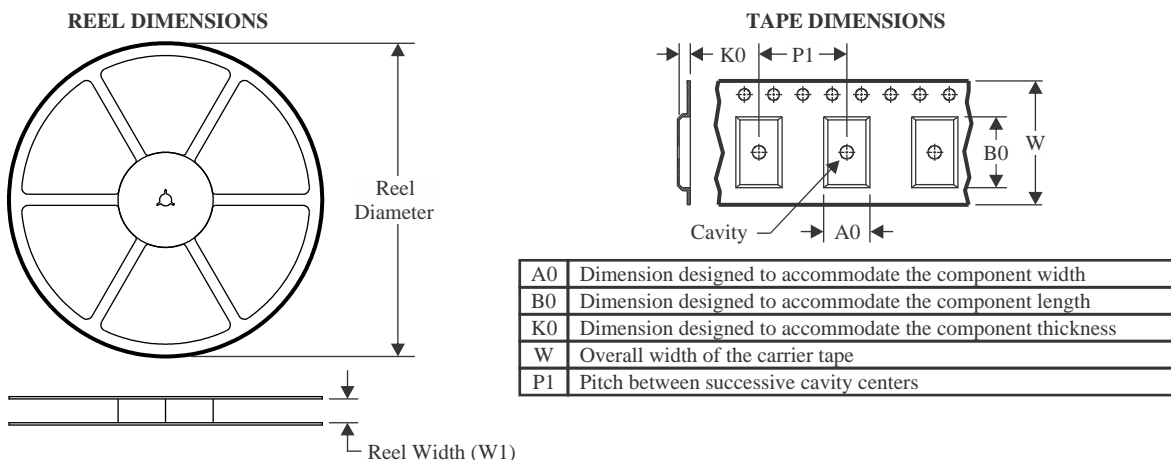

QUADRANT ASSIGNMENTS FOR PIN 1 ORIENTATION IN TAPE

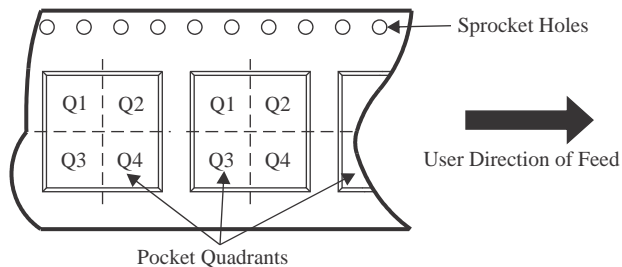

*All dimensions are nominal

Device	Package Type	Package Drawing	Pins	SPQ	Reel Diameter (mm)	Reel Width W1 (mm)	A0 (mm)	B0 (mm)	K0 (mm)	P1 (mm)	W (mm)	Pin1 Quadrant
DAC8822QDBTR	TSSOP	DBT	38	2000	330.0	16.4	6.9	10.2	1.8	12.0	16.0	Q1
DAC8822QCDBTR	TSSOP	DBT	38	2000	330.0	16.4	6.9	10.2	1.8	12.0	16.0	Q1
DAC8822QCDBTRG4	TSSOP	DBT	38	2000	330.0	16.4	6.9	10.2	1.8	12.0	16.0	Q1

TAPE AND REEL BOX DIMENSIONS

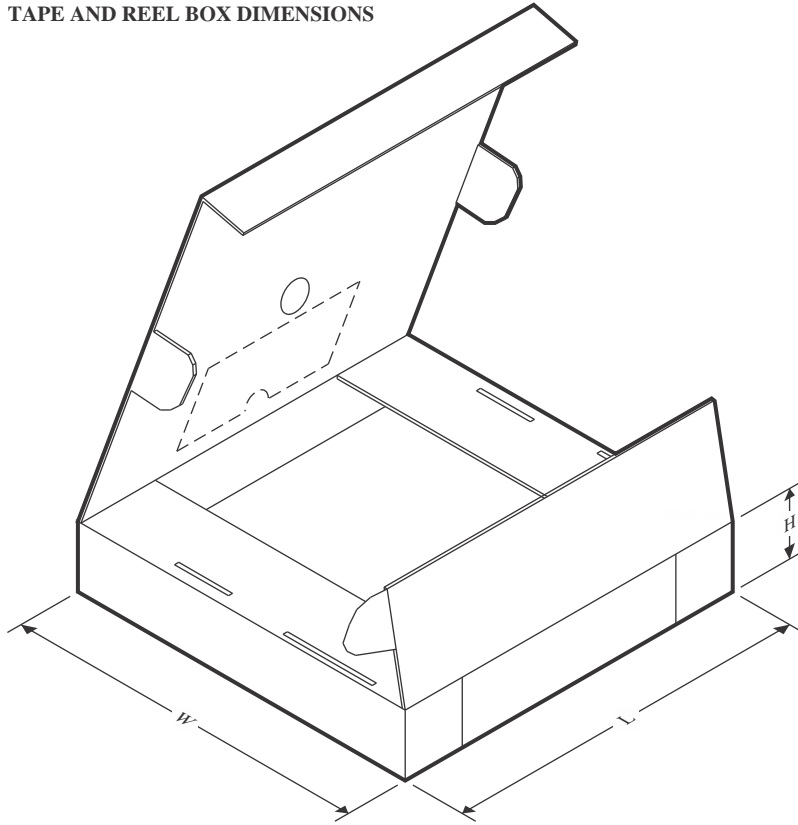

*All dimensions are nominal

Device	Package Type	Package Drawing	Pins	SPQ	Length (mm)	Width (mm)	Height (mm)
DAC8822QBDBTR	TSSOP	DBT	38	2000	350.0	350.0	43.0
DAC8822QCDBTR	TSSOP	DBT	38	2000	350.0	350.0	43.0
DAC8822QCDBTRG4	TSSOP	DBT	38	2000	350.0	350.0	43.0

TUBE

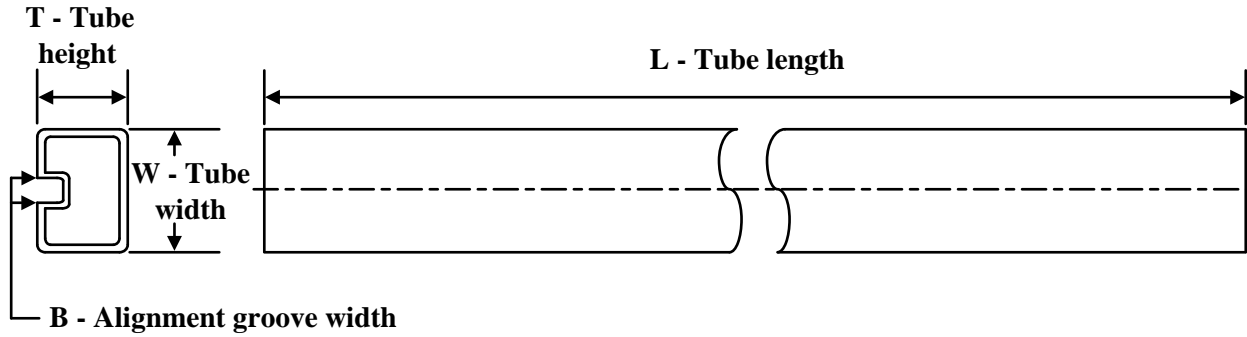

*All dimensions are nominal

Device	Package Name	Package Type	Pins	SPQ	L (mm)	W (mm)	T (μm)	B (mm)
DAC8822QBDBT	DBT	TSSOP	38	50	530	10.2	3600	3.5
DAC8822QBDBT.A	DBT	TSSOP	38	50	530	10.2	3600	3.5
DAC8822QBDBTG4	DBT	TSSOP	38	50	530	10.2	3600	3.5
DAC8822QBDBTG4.A	DBT	TSSOP	38	50	530	10.2	3600	3.5
DAC8822QCDBT	DBT	TSSOP	38	50	530	10.2	3600	3.5
DAC8822QCDBT.A	DBT	TSSOP	38	50	530	10.2	3600	3.5
DAC8822QCDBTG4	DBT	TSSOP	38	50	530	10.2	3600	3.5

EXAMPLE BOARD LAYOUT

DBT0038A

TSSOP - 1.2 mm max height

SMALL OUTLINE PACKAGE

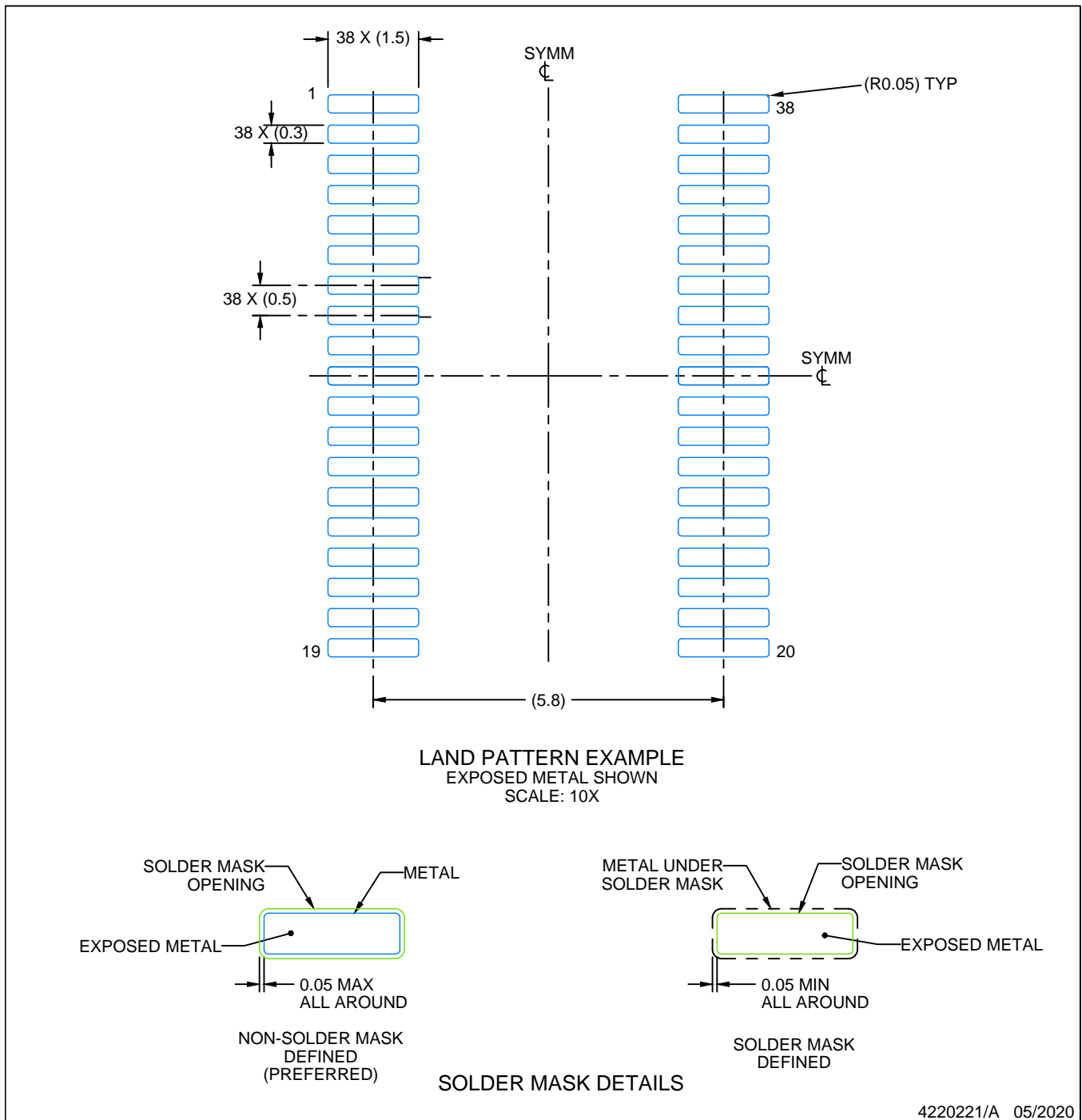

NOTES: (continued)

- 6. Publication IPC-7351 may have alternate designs.
- 7. Solder mask tolerances between and around signal pads can vary based on board fabrication site.

EXAMPLE STENCIL DESIGN

DBT0038A

TSSOP - 1.2 mm max height

SMALL OUTLINE PACKAGE

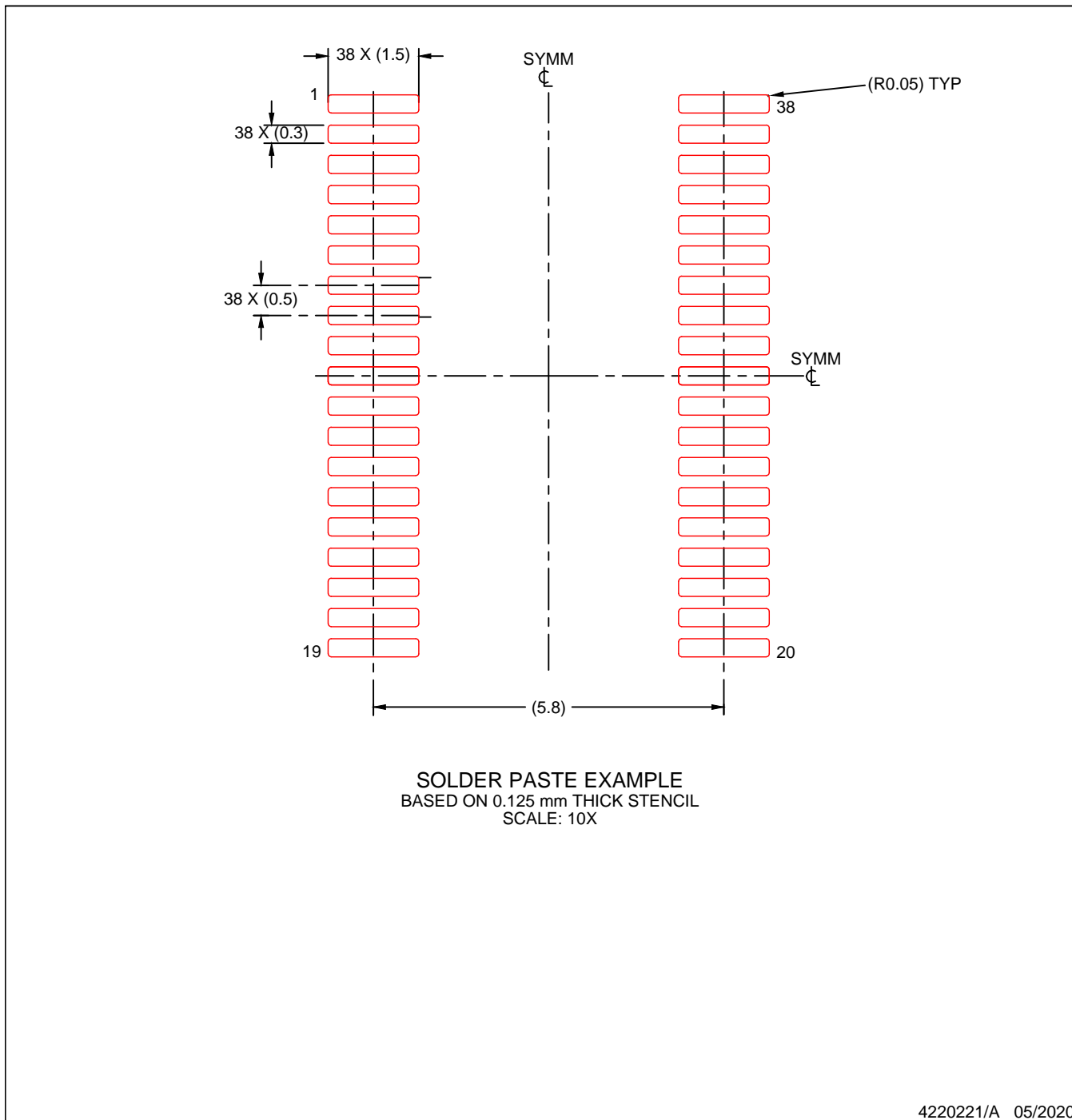

4220221/A 05/2020

NOTES: (continued)

- 8. Laser cutting apertures with trapezoidal walls and rounded corners may offer better paste release. IPC-7525 may have alternate design recommendations.
- 9. Board assembly site may have different recommendations for stencil design.

IMPORTANT NOTICE AND DISCLAIMER

TI PROVIDES TECHNICAL AND RELIABILITY DATA (INCLUDING DATASHEETS), DESIGN RESOURCES (INCLUDING REFERENCE DESIGNS), APPLICATION OR OTHER DESIGN ADVICE, WEB TOOLS, SAFETY INFORMATION, AND OTHER RESOURCES "AS IS" AND WITH ALL FAULTS, AND DISCLAIMS ALL WARRANTIES, EXPRESS AND IMPLIED, INCLUDING WITHOUT LIMITATION ANY IMPLIED WARRANTIES OF MERCHANTABILITY, FITNESS FOR A PARTICULAR PURPOSE OR NON-INFRINGEMENT OF THIRD PARTY INTELLECTUAL PROPERTY RIGHTS.

These resources are intended for skilled developers designing with TI products. You are solely responsible for (1) selecting the appropriate TI products for your application, (2) designing, validating and testing your application, and (3) ensuring your application meets applicable standards, and any other safety, security, regulatory or other requirements.

These resources are subject to change without notice. TI grants you permission to use these resources only for development of an application that uses the TI products described in the resource. Other reproduction and display of these resources is prohibited. No license is granted to any other TI intellectual property right or to any third party intellectual property right. TI disclaims responsibility for, and you fully indemnify TI and its representatives against any claims, damages, costs, losses, and liabilities arising out of your use of these resources.

TI's products are provided subject to [TI's Terms of Sale](#), [TI's General Quality Guidelines](#), or other applicable terms available either on [ti.com](#) or provided in conjunction with such TI products. TI's provision of these resources does not expand or otherwise alter TI's applicable warranties or warranty disclaimers for TI products. Unless TI explicitly designates a product as custom or customer-specified, TI products are standard, catalog, general purpose devices.

TI objects to and rejects any additional or different terms you may propose.

Copyright © 2025, Texas Instruments Incorporated

Last updated 10/2025

OUR CERTIFICATE

DiGi provide top-quality products and perfect service for customer worldwide through standardization, technological innovation and continuous improvement. DiGi through third-party certification, we stricly control the quality of products and services. Welcome your RFQ to

Email: Info@DiGi-Electronics.com



Tel: +00 852-30501935

RFQ Email: Info@DiGi-Electronics.com

DiGi is a global authorized distributor of electronic components.