

HDC2080DMBT Datasheet



<https://www.DiGi-Electronics.com>

DiGi Electronics Part Number	HDC2080DMBT-DG
Manufacturer	Texas Instruments
Manufacturer Product Number	HDC2080DMBT
Description	HUMIDITY SENSOR
Detailed Description	Humidity, Temperature 0 ~ 100% RH I2C ±2% RH 8 s Surface Mount



Tel: +00 852-30501935

RFQ Email: Info@DiGi-Electronics.com

DiGi is a global authorized distributor of electronic components.

Purchase and inquiry

Manufacturer Product Number:

HDC2080DMBT

Series:

-

Sensor Type:

Humidity, Temperature

Output Type:

I2C

Accuracy:

±2% RH

Sensitivity:

-

Mounting Type:

Surface Mount

Package / Case:

6-WDFN Exposed Pad

Base Product Number:

HDC2080

Manufacturer:

Texas Instruments

Product Status:

Obsolete

Humidity Range:

0 ~ 100% RH

Output:

14b

Response Time:

8 s

Voltage - Supply:

1.62V ~ 3.6V

Operating Temperature:

-40°C ~ 85°C

Supplier Device Package:

6-WSON (3x3)

Environmental & Export classification

RoHS Status:

ROHS3 Compliant

REACH Status:

REACH Unaffected

HTSUS:

8542.39.0001

Moisture Sensitivity Level (MSL):

1 (Unlimited)

ECCN:

EAR99

HDC2080 Low-Power Humidity and Temperature Digital Sensor

1 Features

- Relative humidity range: 0% to 100%
- Humidity accuracy: $\pm 2\%$ (typical), $\pm 3\%$ (maximum)
- Temperature accuracy: $\pm 0.2^\circ\text{C}$ (typical), $\pm 0.4^\circ\text{C}$ (maximum)
- Sleep mode current: 50 nA (typical), 100 nA (maximum)
- Average supply current (1 measurement/second)
 - 300 nA: RH% only (11 bit)
 - 550 nA: RH% (11 bit) + temperature (11 bit)
- Temperature range:
 - Operating: -40°C to 85°C
 - Functional: -40°C to 125°C
- Supply voltage range: 1.62 V to 3.6 V
- Available auto measurement mode
- I²C interface compatibility

2 Applications

- Smart thermostats
- Smart home assistants
- Washer/dryers
- HVAC systems
- Inkjet printers

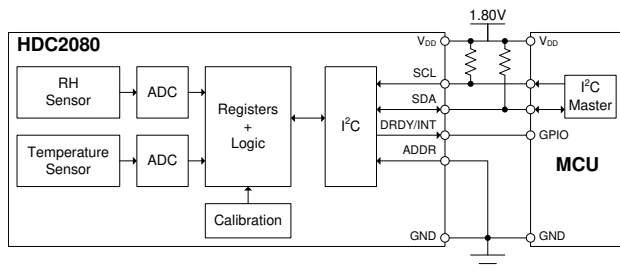

Typical Application

3 Description

The HDC2080 device is an integrated humidity and temperature sensor that provides high accuracy measurements with very low power consumption in a small DFN package. The capacitive-based sensor includes new integrated digital features and a heating element to dissipate condensation and moisture. The HDC2080 digital features include programmable interrupt thresholds to provide alerts and system wake-ups without requiring a microcontroller to be continuously monitoring the system. Combined with programmable sampling intervals, a low power consumption, and a support for a 1.8-V supply voltage, the HDC2080 is designed for battery-operated systems.

The HDC2080 provides high accuracy measurement capability for a wide range of environmental monitoring and Internet of Things (IoT) applications such as smart thermostats and smart home assistants. For designs where printed-circuit board (PCB) area is critical, a smaller CSP package option is available thru the HDC2010 with complete software compatibility with the HDC2080.

For applications with strict power-budget restrictions, Auto Measurement Mode enables the HDC2080 to automatically initiate temperature and humidity measurements. This feature allows users to configure a microcontroller into deep sleep mode because the HDC2080 is no longer dependent upon the microcontroller to initiate a measurement.

Device Information⁽¹⁾

PART NUMBER	PACKAGE	BODY SIZE (NOM)
HDC2080	WSON (6)	3.00 mm × 3.00 mm

- (1) For all available packages, see the orderable addendum at the end of the data sheet.

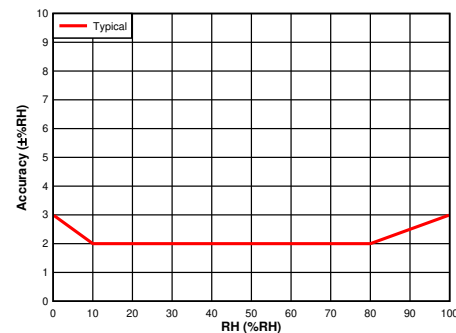

RH Accuracy ($T_A = 30^\circ\text{C}$)



Table of Contents

1 Features	1	8.4 Device Functional Modes.....	16
2 Applications	1	8.5 Programming.....	16
3 Description	1	8.6 Register Maps.....	17
4 Revision History	2	9 Application and Implementation	30
5 Description (continued)	4	9.1 Application Information.....	30
6 Pin Configuration and Functions	4	9.2 Typical Application.....	30
7 Specifications	5	10 Power Supply Recommendations	32
7.1 Absolute Maximum Ratings	5	11 Layout	32
7.2 ESD Ratings	5	11.1 Layout Guidelines.....	32
7.3 Recommended Operating Conditions	5	11.2 Layout Example.....	34
7.4 Thermal Information	5	12 Device and Documentation Support	35
7.5 Electrical Characteristics	6	12.1 Documentation Support.....	35
7.6 Switching Characteristics	7	12.2 Receiving Notification of Documentation Updates..	35
7.7 Timing Diagram.....	7	12.3 Support Resources.....	35
7.8 Typical Characteristics.....	8	12.4 Trademarks.....	35
8 Detailed Description	9	12.5 Electrostatic Discharge Caution.....	35
8.1 Overview.....	9	12.6 Glossary.....	35
8.2 Functional Block Diagram.....	9	13 Mechanical, Packaging, and Orderable Information	35
8.3 Feature Description.....	9		

4 Revision History

Changes from Revision B (May 2019) to Revision C (July 2021)	Page
• Removed GND pin absolute maximum rating.....	5
• Added DRDY/INT pin absolute maximum rating.....	5
• Added information from multiple table footnotes to Recommended Operating Conditions table.....	5
• Changed temperature accuracy maximum for 5°C < TA < 60°C.....	6
• Added TEMP _{PSRR} parameter.....	6
• Changed reference material for <i>Storage and Handling</i>	9
• Added content to the <i>Heater</i> section.....	10
• Added 0.5 to make Equation 1 –40.5 match more closely to the silicon and added PSRR equation.....	18
• Added 0.5 to make Equation 4 –40.5 match more closely to the silicon and added PSRR equation.....	21
• Added 0.5 to make Equation 7 –40.5 match more closely to the silicon and added PSRR equation	25
• Added 0.5 to make Equation 9 –40.5 match more closely to the silicon and added PSRR equation.....	25
• Changed reference material in the <i>Storage and Handling</i> section.....	32
• Added <i>Typical Relative Humidity Accuracy Range Limits</i> graphic.....	32
Changes from Revision A (October 2018) to Revision B (May 2019)	Page
• Added the pin type for DRDY/INT pin	4
• Changed description of behavior of TH_STATUS bit when INT_MODE is set to 1.....	12
• Changed description of behavior of TH_STATUS bit when INT_MODE is set to 0	12
• Changed description of behavior of TL_STATUS bit when INT_MODE is set to 1.....	13
• Changed description of behavior of TL_STATUS bit when INT_MODE is set to 0	13
• Changed description of behavior of HH_STATUS bit when INT_MODE is set to 1.....	14
• Changed description of behavior of HH_STATUS bit when INT_MODE is set to 0.....	14
• Changed description of behavior of HL_STATUS bit when INT_MODE is set to 1.....	15
• Changed description of behavior of HL_STATUS bit when INT_MODE is set to 0	15
• Changed the units for Humidity threshold low from: °C to: %RH.....	26
• Changed the temperature resolution decoding from: 8 bit to: 9 bit	28
• Changed the humidity resolution decoding from: 8 bit to: 9 bit	28
• Changed the measurement configuration "10" bit encoding from: Humidity Only to: NA for field MEAS_CONF[1:0]	28

Changes from Revision * (May 2018) to Revision A (October 2018)	Page
• Changed header cell in the <i>Read Single Byte</i> table from: Slave address (R) to: Slave address (W).....	16
• Changed header cell in the <i>Read Multi Byte</i> table from: Slave address (R) to: Slave address (W).....	16

HDC2080

SNAS678C – MAY 2018 – REVISED JULY 2021

5 Description (continued)

Programmable temperature and humidity thresholds in the HDC2080 allow the device to send a hardware interrupt to wake up the microcontroller when necessary. In addition, the power consumption of the HDC2080 is significantly reduced, which helps to minimize self-heating and improve measurement accuracy.

The HDC2080 is factory-calibrated to 0.2°C temperature accuracy and 2% relative humidity accuracy.

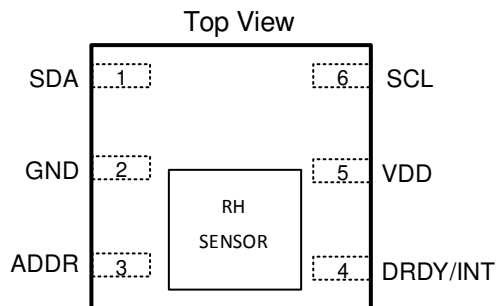
6 Pin Configuration and Functions**Figure 6-1. DMB Package 6-Pin PWSON Top View****Table 6-1. Pin Functions**

PIN		I/O	DESCRIPTION
NAME	NO.		
SDA	1	I/O	Serial data line for I ² C, open-drain; requires a pullup resistor to V _{DD}
GND	2	G	Ground
ADDR	3	I	Address select pin – leave unconnected or hardwired to V _{DD} or GND. Unconnected slave address: 1000000 GND: slave address: 1000000 V _{DD} : slave address: 1000001
DRDY/INT	4	O	Data ready/Interrupt. Push-pull output
V _{DD}	5	P	Positive Supply Voltage
SCL	6	I	Serial clock line for I ² C, open-drain; requires a pullup resistor to V _{DD}

7 Specifications

7.1 Absolute Maximum Ratings

over operating free-air temperature range (unless otherwise noted)⁽¹⁾

		MIN	MAX	UNIT
V _{DD}	Applied Voltage on VDD pin	-0.3	3.9	V
ADDR	Applied Voltage on ADDR pin	-0.3	3.9	V
SCL	Applied Voltage on SCL pin	-0.3	3.9	V
SDA	Applied Voltage on SDA pin	-0.3	3.9	V
DRDY/INT	Applied Voltage on DRDY/INT PIN	-0.3	V _{DD} + 0.3	V
T _{stg}	Storage temperature	-65	150	°C

- (1) Stresses beyond those listed under *Absolute Maximum Ratings* may cause permanent damage to the device. These are stress ratings only, which do not imply functional operation of the device at these or any other conditions beyond those indicated under *Recommended Operating Conditions*. Exposure to absolute-maximum-rated conditions for extended periods may affect device reliability.

7.2 ESD Ratings

			VALUE	UNIT
V _(ESD)	Electrostatic discharge	Human body model (HBM), per ANSI/ESDA/JEDEC JS-001 ⁽¹⁾	±2000	V
		Charged device model (CDM), per JEDEC specification JESD22-C101 ⁽²⁾	±500	

- (1) JEDEC document JEP155 states that 500-V HBM allows safe manufacturing with a standard ESD control process.
 (2) JEDEC document JEP157 states that 250-V CDM allows safe manufacturing with a standard ESD control process.

7.3 Recommended Operating Conditions

PARAMETER		MIN	MAX	UNIT
V _{DD}	Supply voltage	1.62	3.6	V
T _{TEMP}	Temperature Sensor - Operating free-air temperature	-40	125	°C
T _{RH}	Relative Humidity Sensor - Operating free-air temperature ⁽¹⁾	-20	70	°C
T _{HEATER}	Integrated Heater - Operating free-air temperature	-40	85	°C
RH _{OR}	Relative Humidity Sensor (Non-condensing) ⁽¹⁾	0	100	%RH

- (1) Prolonged operation outside the recommended temperature operating conditions and/or at >80%RH with temperature in the higher recommended operating range can result in a shift of sensor reading, with slow recovery time. See [High Temperature and Humidity Exposure](#) for more details.

7.4 Thermal Information

THERMAL METRIC ⁽¹⁾		HDC2080	UNIT
		WS0N (DMB)	
		6 PINS	
R _{θJA}	Junction-to-ambient thermal resistance	56.4	°C/W
R _{θJC(top)}	Junction-to-case (top) thermal resistance	73.6	°C/W
R _{θJB}	Junction-to-board thermal resistance	24.0	°C/W
Ψ _{JT}	Junction-to-top characterization parameter	3.8	°C/W
Ψ _{JB}	Junction-to-board characterization parameter	24.0	°C/W
R _{θJC(bot)}	Junction-to-case (bottom) thermal resistance	13.0	°C/W

- (1) For more information about traditional and new thermal metrics, see the [Semiconductor and IC Package Thermal Metrics](#) application report.

HDC2080

SNAS678C – MAY 2018 – REVISED JULY 2021

7.5 Electrical Characteristics $T_A = 30^\circ\text{C}$, $V_{DD} = 1.8\text{V}$, $20\% \leq \text{RH} \leq 80\%$ (unless otherwise noted)

PARAMETER		TEST CONDITIONS	MIN	TYP	MAX	UNIT
POWER CONSUMPTION						
I_{DD}	Supply Current	RH Measurement ⁽¹⁾		650	890	μA
I_{DD}	Supply Current	Temperature Measurement ⁽¹⁾		550	730	μA
I_{DD}	Supply Current	Sleep Mode		0.05	1	μA
I_{DD}	Supply Current	Averaged at 1 sample per second, RH or Temperature only ^{(1) (2)}		0.3		μA
I_{DD}	Supply Current	Averaged at 1 sample per second, RH (11 bit) and Temperature (11 bit) ^{(1) (2)}		0.55		μA
I_{DD}	Supply Current	Averaged at 1 sample per 2 seconds, RH (11 bit) and Temperature (11 bit) ^{(1) (2)}		0.3		μA
I_{DD}	Supply Current	Averaged at 1 sample per 10 seconds, RH (11 bit) and Temperature (11 bit) ^{(1) (2)}		0.105		μA
I_{DD}	Supply Current	Startup (average on startup time)		80		μA
I_{HEATER}	Integrated Heater (when enabled)	$V_{DD} = 3.3\text{V}$		90		mA
RELATIVE HUMIDITY SENSOR						
RH_{ACC}	Accuracy ^{(3) (4)}	$0^\circ\text{C} < T_A < 60^\circ\text{C}$. Non-Condensing.		± 2	± 3	%RH
RH_{REP}	Repeatability ⁽⁵⁾	14 bit resolution		± 0.1		%RH
RH_{HYS}	Hysteresis ⁽⁶⁾			± 1		%RH
RH_{HYS}	Response Time ⁽⁷⁾	$t_{63\% \text{ step}}^{(8)}$		8		s
RH_{CT}	Conversion-time ⁽⁵⁾	9 bit accuracy		275		μs
RH_{CT}	Conversion-time ⁽⁵⁾	11 bit accuracy		400		μs
RH_{CT}	Conversion-time ⁽⁵⁾	14 bit accuracy		660		μs
RH_{LTD}	Long-term Drift ⁽⁹⁾			± 0.25		%RH/yr
TEMPERATURE SENSOR						
TEMP_{AC} C	Accuracy ⁽⁵⁾	$5^\circ\text{C} < T_A < 60^\circ\text{C}$		± 0.2	± 0.7	$^\circ\text{C}$
		$10^\circ\text{C} < T_A < 35^\circ\text{C}$		± 0.2	± 0.4	
TEMP_{RE} P	Repeatability ⁽⁵⁾	14 bit resolution		± 0.1		$^\circ\text{C}$
TEMP_{CT}	Conversion-time ⁽⁵⁾	9 bit accuracy		225		μs
TEMP_{CT}	Conversion-time ⁽⁵⁾	11 bit accuracy		350		μs
TEMP_{CT}	Conversion-time ⁽⁵⁾	14 bit accuracy		610		μs
TEMP_{PS} RR	Supply Sensitivity on accuracy	$V_{DD} = 1.8\text{V}$ to 3.6V		0.08		$^\circ\text{C}/\text{V}$
SCL, SDA PINS						
V_{IH}	HIGH-level input voltage		$0.7 \times V_{DD}$			V
V_{IL}	LOW-level input voltage			$0.3 \times V_{DD}$		V
V_{OL}	LOW-level output voltage	$I_{OL} = 3 \text{ mA}$			0.4	V
V_{HYS}	Hysteresis of Schmitt trigger inputs		$0.1 \times V_{DD}$			V
C_{IN}	Input Capacitance ⁽⁵⁾			0.5		pF

- (1) Does not include I2C read/write communication or pullup resistor current through SCL and SDA
- (2) Average current consumption while conversion is in progress
- (3) Excludes hysteresis and long-term drift
- (4) Excludes the impact of dust, gas phase solvents and other contaminants such as vapors from packaging materials, adhesives, or tapes, etc.
- (5) This parameter is specified by design and/or characterization and is not tested in production
- (6) The hysteresis value is the difference between the RH measurement in a rising and falling RH environment, at a specific RH point
- (7) Actual response times will vary dependent on system thermal mass and air-flow
- (8) Time for the RH output to change by 63% of the total RH change after a step change in environmental humidity

- (9) Drift due to aging effects at typical conditions (30°C and 20% to 50% RH). This value may be impacted by dust, vaporized solvents, outgassing tapes, adhesives, packaging materials, etc.

7.6 Switching Characteristics

$T_A = 30^\circ\text{C}$ and $V_{DD} = 1.80\text{V}$ (unless otherwise noted); values are based on statistical analysis of samples tested during initial release

PARAMETER		TEST CONDITIONS	MIN	TYP	MAX	UNIT
SCL, SDA PINS						
f_{SCL}	SCL clock frequency ⁽¹⁾		10		400	kHz
t_{LOW}	LOW period of the SCL clock ⁽¹⁾		1.3			μs
t_{HIGH}	High period of the SCL clock ⁽¹⁾		0.6			μs

- (1) Guaranteed by design/characterization; not tested in production

7.7 Timing Diagram

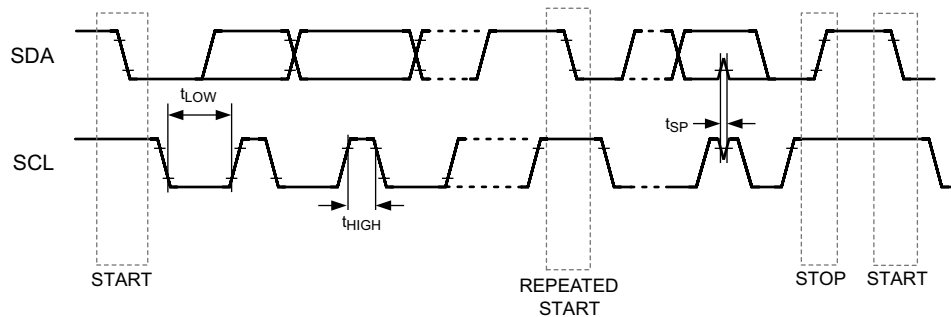

Figure 7-1. I2C Timing

HDC2080

SNAS678C – MAY 2018 – REVISED JULY 2021

7.8 Typical Characteristics

Unless otherwise noted. $T_A = 30^\circ\text{C}$, $V_{DD} = 1.80\text{ V}$.

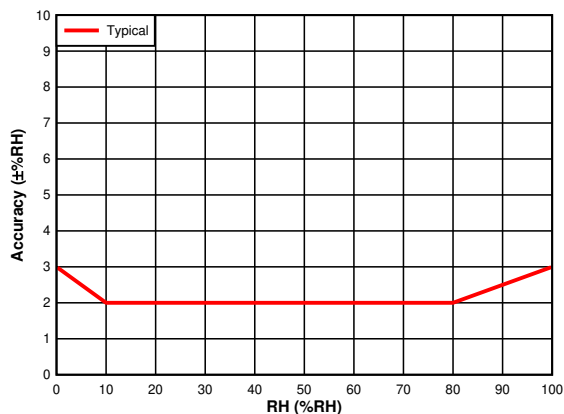

Figure 7-2. RH Accuracy vs. RH Set Point

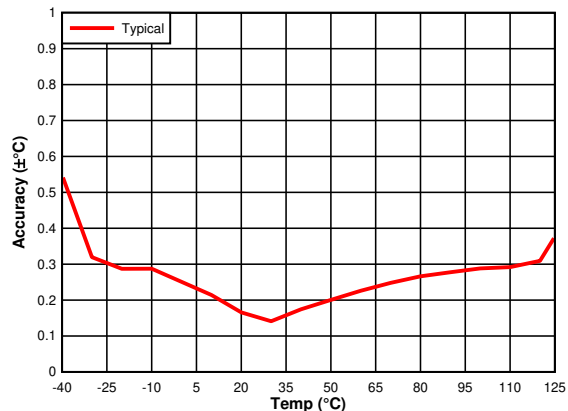

Figure 7-3. Temperature Accuracy vs. Temperature Set Point

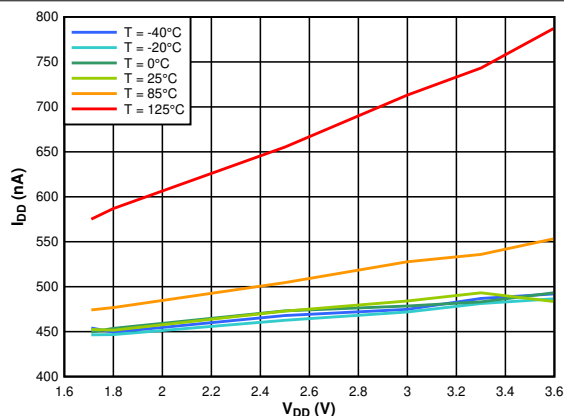

Figure 7-4. Supply Current vs. Supply Voltage, Average at 1 Measurement/Second, RH (11 Bit) and Temperature (11 Bit)

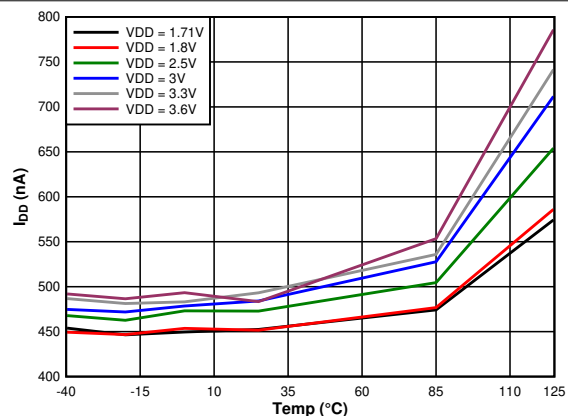

Figure 7-5. Supply Current vs. Temperature, Average at 1 Measurement/Second, RH (11 Bit) and Temperature (11 Bit)

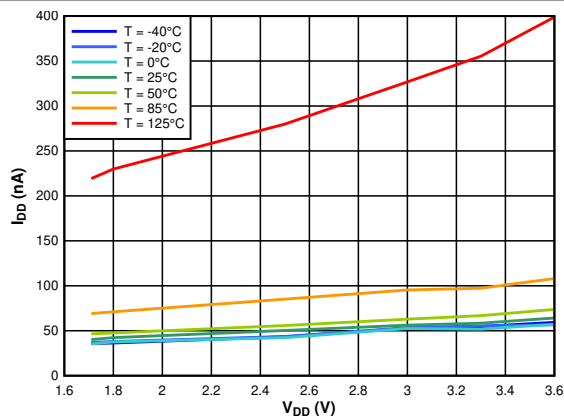

Figure 7-6. Supply Current vs. Supply Voltage, Sleep Mode

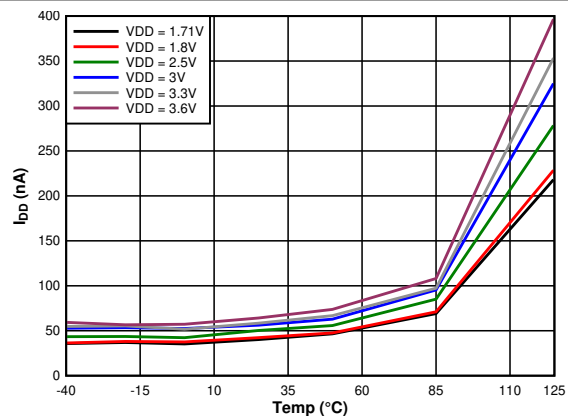

Figure 7-7. Supply Current vs. Temperature, Sleep Mode

8 Detailed Description

8.1 Overview

The HDC2080 is a highly integrated digital humidity and temperature sensor that incorporates both humidity-sensing and temperature-sensing elements, an analog-to-digital converter, calibration memory, and an I²C interface that are all contained in a 3.00-mm × 3.00-mm 6-pin WSON package. The HDC2080 provides excellent measurement accuracy with very low power consumption and features programmable resolution for both humidity and temperature:

- Temperature resolution [9, 11, 14]
- Humidity resolution [9, 11, 14]

The conversion time during measurements is dependent upon the configured resolution for humidity and temperature, which can be configured for optimal power consumption.

The HDC2080 device incorporates a state-of-the-art polymer dielectric to provide capacitive-sensing measurements. As with most relative humidity sensors that include this type of technology, the user must meet certain application requirements to ensure optimal device performance for the sensing element. The user must:

- Follow the correct storage and handling procedures during board assembly. See [HDC20xx Silicon User's Guide](#)(SNAU250) for these guidelines.
- Protect the sensor from contaminants during board assembly and operation.
- Reduce prolonged exposure to both high temperature and humidity extremes that may impact sensor accuracy.
- Follow the correct layout guidelines for best performance. See [Optimizing Placement and Routing for Humidity Sensors](#) (SNAA297) for these guidelines.

8.2 Functional Block Diagram

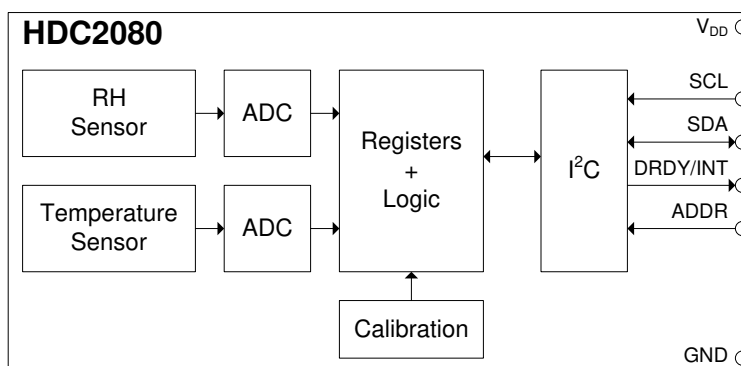

8.3 Feature Description

8.3.1 Sleep Mode Power Consumption

One key feature of the HDC2080 is the low power consumption of the device, which makes the HDC2080 suitable in battery-powered or energy-harvesting applications. In these applications, the HDC2080 spends most of the time in sleep mode that has a typical current consumption of 50 nA. This minimizes the average power consumption and self-heating.

8.3.2 Measurement Modes: Trigger on Demand vs. Auto Measurement

Two types of measurement modes are available on the HDC2080: Trigger on Demand and Auto Mode.

Trigger on Demand is when each measurement reading are initiated through an I²C command on an as-needed basis. After the measurement is converted, the device remains in sleep mode until another I²C command is received.

Auto Measurement Mode is when the HDC2080 is programmed to perform measurement readings on a periodic basis, thus eliminating the need to initiate a measurement request through an I²C command and improves power consumption. The user can adjust the Soft Reset and Interrupt Configuration register to select one of 7 different

HDC2080

SNAS678C – MAY 2018 – REVISED JULY 2021

sampling rates (the range spans from 1 sample every 2 minutes to 5 samples/second). In Auto Measurement Mode, the HDC2080 wakes up from sleep to measurement mode based on the selected sampling rate.

8.3.3 Heater

The HDC2080 includes an integrated heating element that can be switched on briefly to prevent or remove any condensation that may build up in high humidity environments. Additionally, the heater can be used to verify functionality of the integrated temperature sensor.

If the dew point of an application is continuously calculated and tracked, and the application firmware is written such that it can detect a potential condensing situation (or a period of it), a software subroutine can be run, as a precautionary measure, to activate the onboard heater as an attempt to remove the condensate. The device shall continue to measure and track the %RH level after the heater is activated. Once the %RH reading goes to zero % (or near it), the heater can be subsequently turned off, allowing the device to cool down. Cooling of the device can take minutes and temperature measurement shall continue to be performed to ensure the device goes back to normal operating condition before restarting the device for normal service.

Note once the heater activates, the operating temperature of the device shall be limited to below 85°C. The heater has a typical current draw of 90 mA at 3.3-V operation and 55 mA at 1.8-V operation.

It is important to recognize that the integrated heater evaporates condensate that forms on top of the humidity sensor, but does not remove any dissolved contaminants. Any contaminant residue, if present, may impact the accuracy of the humidity sensor.

8.3.4 Interrupt Description

Note

When multiple bits are enabled, the DRDY/INT pin can only reflect the status of one interrupt bit at a time. The DRDY/INT pin DOES NOT function as the logical 'OR' of interrupt bits that have been enabled.

The highest priority is given to TH_ENABLE bit, followed by TL_ENABLE, HH_ENABLE, and HL_ENABLE bits in descending order. Therefore, programming recommendations are provided as below:

- The DRDY/INT will track the HL_ENABLE if enabled and all other ENABLE bits are disabled
 - The DRDY/INT will track the HH_ENABLE if enabled and the TH_ENABLE and TL_ENABLE are disabled
 - The DRDY/INT will track the TL_ENABLE if enabled and the TH_ENABLE is disabled
 - The DRDY/INT will track the TH_ENABLE if enabled and is independent of other ENABLE bit settings
-

8.3.4.1 DRDY

When DRDY_ENABLE is enabled and a humidity and/or temperature conversion is complete, the DRDY_STATUS bit asserts to 1. To enable the DRDY/INT pin of HDC2080, the DRDY/INT_EN bit (0x0E bit[2]) must be set to 1 and the INT_MOD bit should be set to 0. If these bits are not configured, the pin will be left in high impedance. The INT_POL bit of this register defines the interrupt polarity of the DRDY/INT pin. [Figure 8-1](#) and [Figure 8-2](#) display the output behavior of the DRDY/INT pin for both interrupt polarity cases: INT_POL= 0 and INT_POL= 1.

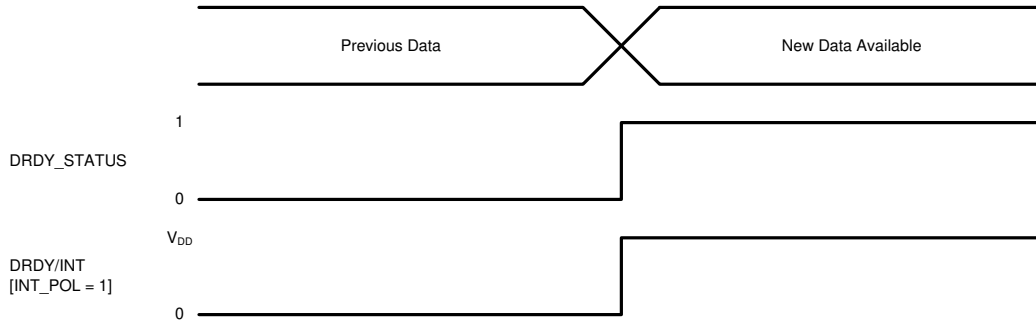

Figure 8-1. Data Ready Interrupt - Active High (INT_POL = 1)

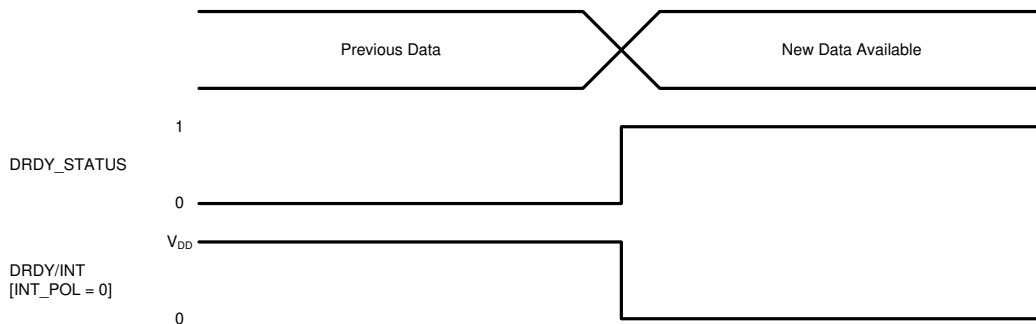

Figure 8-2. Data Ready Interrupt - Active Low (INT_POL = 0)

HDC2080

SNAS678C – MAY 2018 – REVISED JULY 2021

8.3.5 INTERRUPT on Threshold**8.3.5.1 Temperature High**

When TH_ENABLE is enabled and the temperature is over the programmed threshold level stored in the Temperature Threshold HIGH register, the TH_STATUS bit asserts to 1. The polarity and interrupt mode of the TH_STATUS bit and the DRDY/INT pin can be configured through the INT_POL and INT_MODE bits of Register 0x0E.

The INT_MODE bit sets the threshold to either comparator mode or a level sensitive alarm.

When INT_MODE is set to 1, the TH_STATUS bit is based on the current temperature conversion. The polarity of the DRDY/INT pin is set by INT_POL.

When INT_MODE is set to 0, the TH_STATUS bit remains set to 1 until it is read. The polarity of the DRDY/INT pin is set by INT_POL.

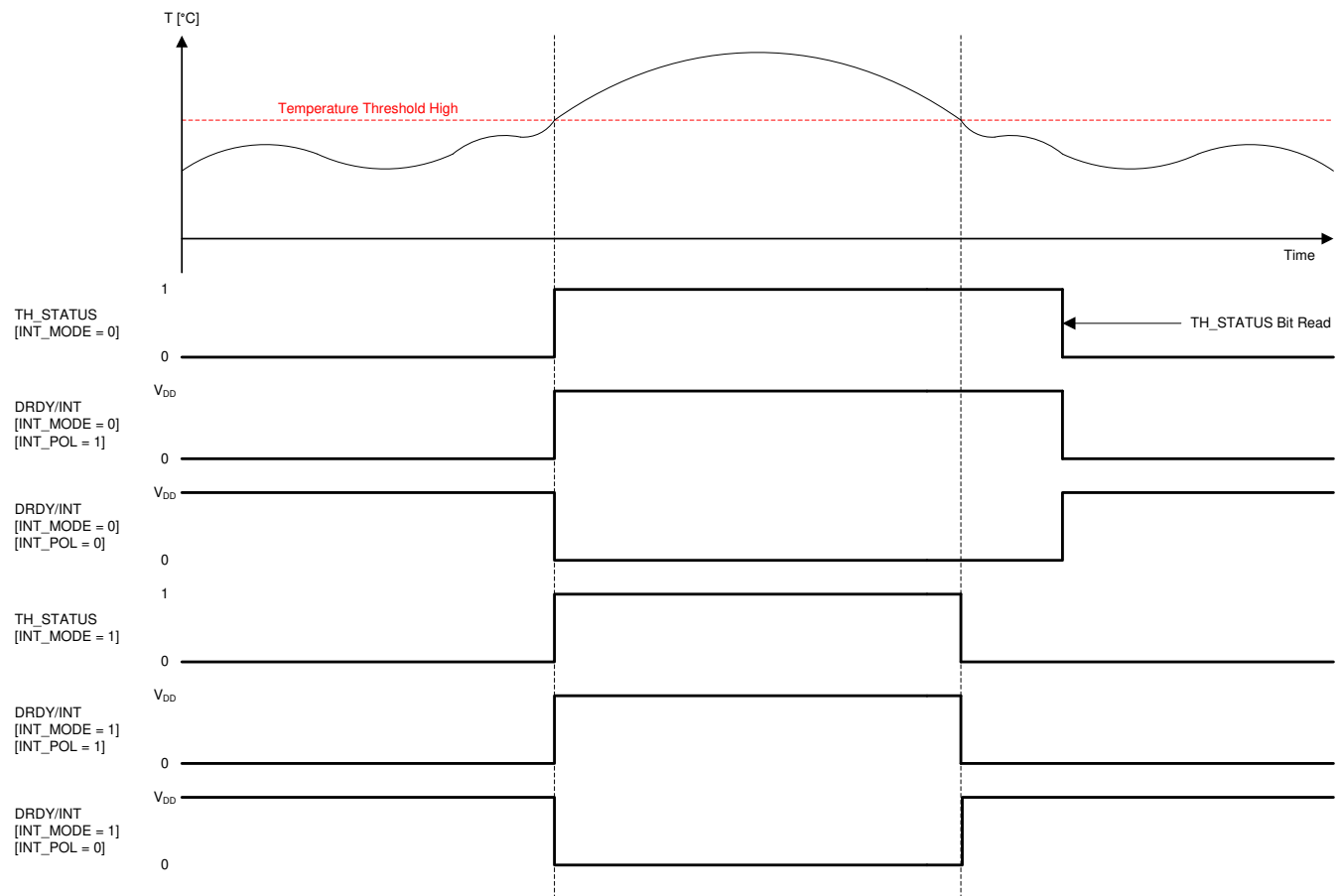

Figure 8-3. INTERRUPT on Threshold - Temperature High

8.3.5.2 Temperature Low

When TL_ENABLE is set and the temperature is under the threshold value program in the Temperature Threshold LOW register, the TL_STATUS bit is set to 1. The TL_STATUS bit and the DRDY/INT pin behave based on the INT_POL and INT_MODE bits.

The INT_MODE bit sets the threshold to either comparator mode or a level sensitive alarm.

When INT_MODE is set to 1, the TL_STATUS bit is based on the current temperature conversion. The polarity of the DRDY/INT pin is set by INT_POL.

When INT_MODE is set to 0, the TL_STATUS bit remains set to 1 until it is read. The polarity of the DRDY/INT pin is set by INT_POL

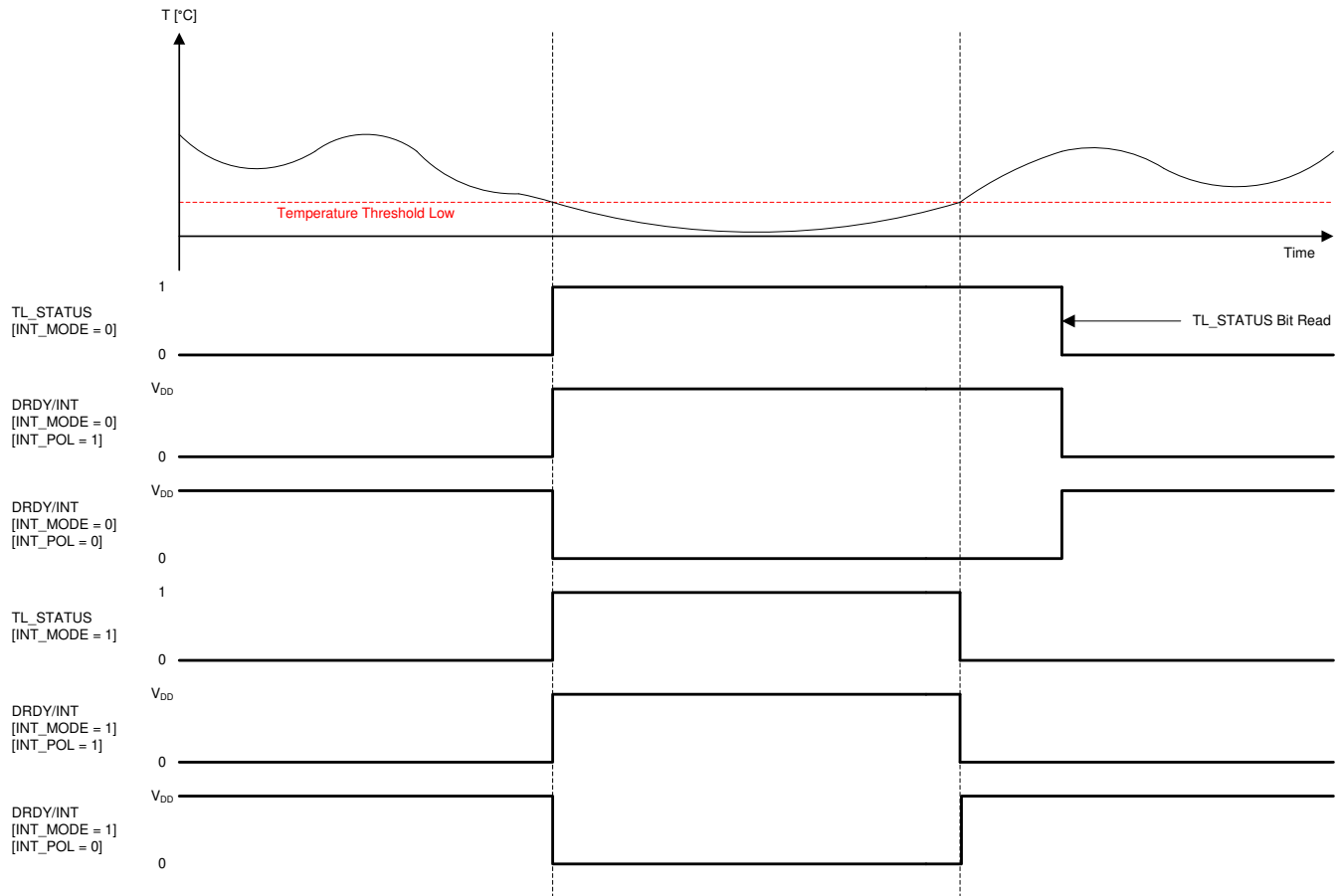

Figure 8-4. INTERRUPT on Threshold - Temperature Low

HDC2080

SNAS678C – MAY 2018 – REVISED JULY 2021

8.3.5.3 Humidity High

When HH_ENABLE is set and the humidity is over the threshold value program in the Humidity Threshold HIGH register, the HH_STATUS bit is set to 1. The HH_STATUS bit and the DRDY/INT pin behave based on the INT_POL and INT_MODE bits.

The INT_MODE bit sets the threshold to either comparator mode or a level sensitive alarm.

When INT_MODE is set to 1, the HH_STATUS bit is based on the current relative humidity conversion. The polarity of the DRDY/INT pin is set by INT_POL.

When INT_MODE is set to 0, the HH_STATUS bit remains set to 1 until it is read. The polarity of the DRDY/INT pin is set by INT_POL

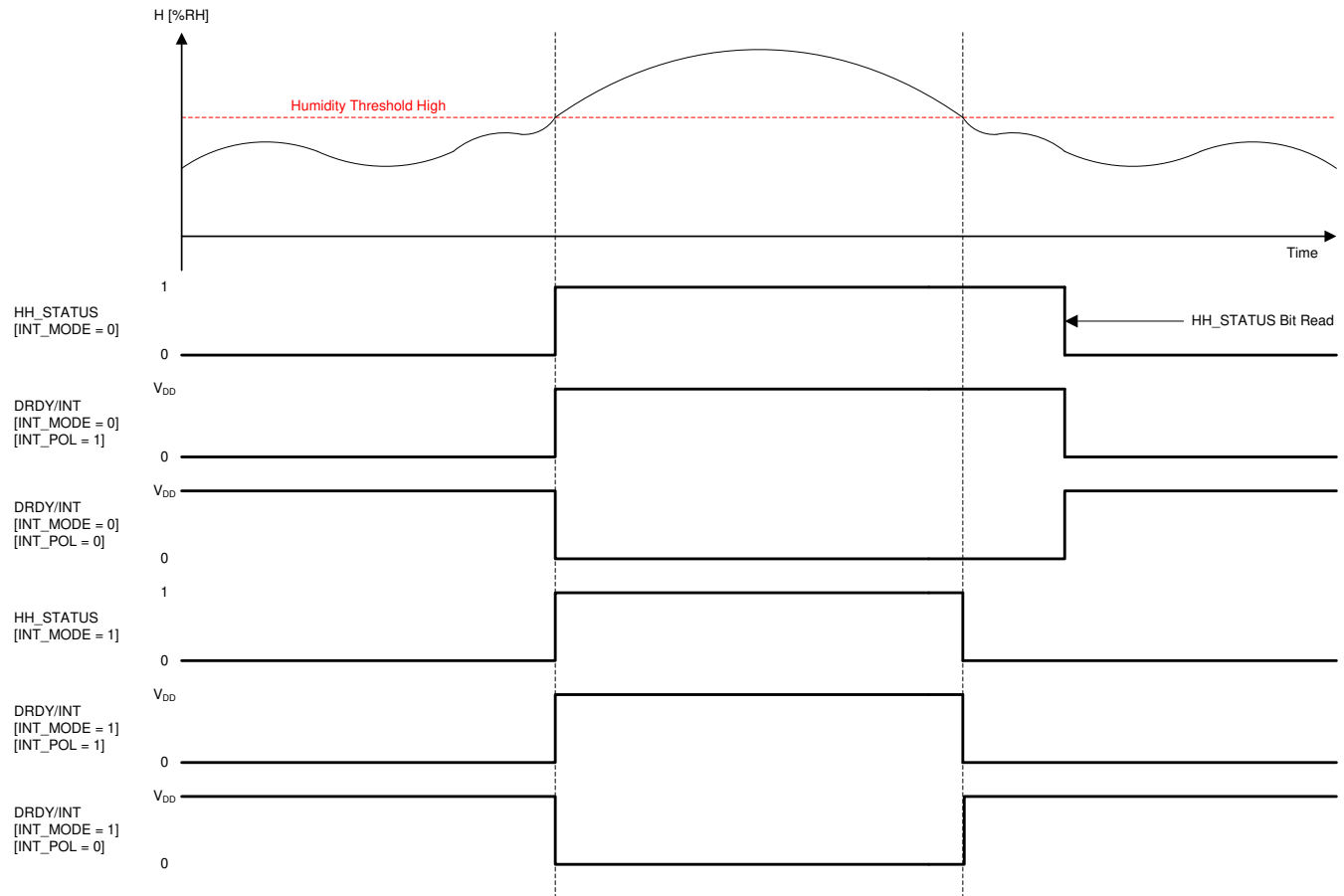
**Figure 8-5. INTERRUPT on Threshold - Humidity High**

8.3.5.4 Humidity Low

When HL_ENALBE is set and the humidity is over the threshold value program in the Humidity Threshold LOW register the HL_STATUS bit is set to 1. The HL_STATUS bit and the DRDY/INT pin behave based on the INT_POL and INT_MODE bits.

The INT_MODE bit sets the threshold to either comparator mode or a level sensitive alarm.

When INT_MODE is set to 1, the HL_STATUS bit is based on the current relative humidity conversion. The polarity of the DRDY/INT pin is set by INT_POL.

When INT_MODE is set to 0, the HL_STATUS bit remains set to 1 until it is read. The polarity of the DRDY/INT pin is set by INT_POL

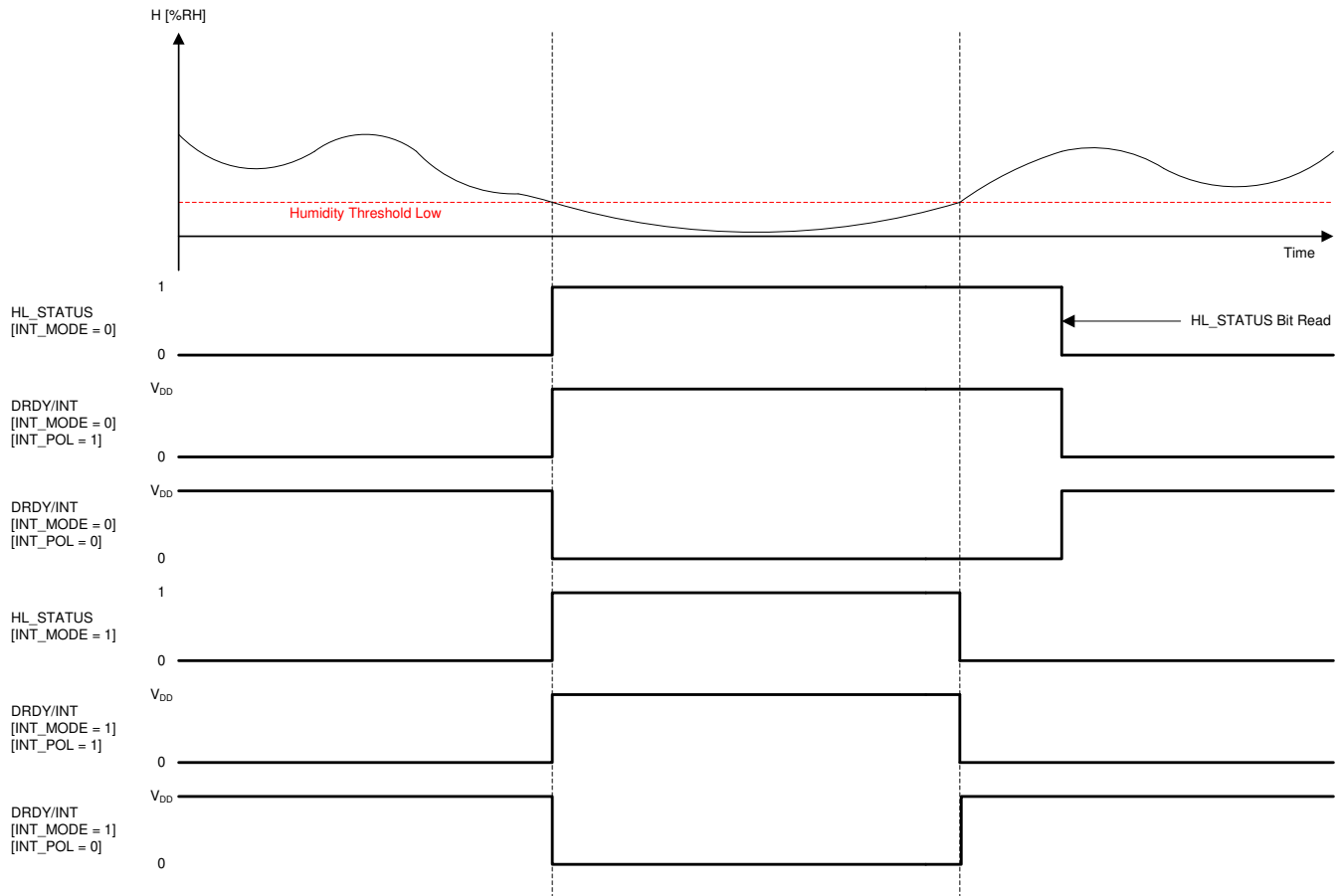

Figure 8-6. INTERRUPT on Threshold - Humidity Low

8.4 Device Functional Modes

The HDC2080 has two modes of operation: Sleep Mode and Measurement Mode.

8.4.1 Sleep Mode vs. Measurement Mode

After power up, the HDC2080 defaults to Sleep Mode and waits for an I²C instruction to set programmable conversion times, trigger a measurement or conversion, or read or write valid data. When a measurement is triggered, the HDC2080 switches to Measurement Mode that converts temperature or humidity values from integrated sensors through an internal ADC and stores the information in their respective data registers. The DRDY/INT pin can be monitored to verify if data is ready after measurement conversion. The DRDY/INT pin polarity and interrupt mode are set according to the configuration of the Interrupt Enable and DRDY/INT Configuration registers. After completing the conversion, the HDC2080 returns to Sleep Mode.

8.5 Programming

8.5.1 I²C Serial Bus Address Configuration

To communicate with the HDC2080, the master must first address slave devices through a slave address byte. The slave address byte consists of seven address bits and a direction bit that indicates the intent to execute a read or write operation. The HDC2080 features an address pin to allow up to 2 devices to be addressed on a single bus. [Table 8-1](#) describes the pin logic levels used to connect up to two devices. ADDR should be set before any activity on the interface occurs and remain constant while the device is powered up.

Table 8-1. HDC2080 I²C Slave Address

ADDR	ADDRESS (7-BIT ADDRESS)
GND	1000000
VDD	1000001

8.5.2 I²C Interface

The HDC2080 operates only as a slave device on the I²C bus interface. It is not allowed to have multiple devices on the same I²C bus with the same address. Connection to the bus is made through the open-drain I/O lines, SDA, and SCL. The SDA and SCL pins feature integrated spike-suppression filters and Schmitt triggers to minimize the effects of input spikes and bus noise. After power-up, the sensor needs at most 3 ms, to be ready to start RH and temperature measurement. After power-up the sensor is in sleep mode until a communication or measurement is performed. All data bytes are transmitted MSB first.

8.5.3 Serial Bus Address

To communicate with the HDC2080, the master must first address slave devices through a slave address byte. The slave address byte consists of seven address bits, and a direction bit that indicates the intent to execute a read or write operation.

8.5.4 Read and Write Operations

Address registers, which hold data pertaining to the status of the device, can be accessed through a pointer mechanism and can be accessed and modified with the following write and read procedures. The register address value is the first byte transferred after the device slave address byte with the R/W bit low. Every write operation to the HDC2080 requires a value for the register address (refer to [Table 8-2](#)).

When reading from the HDC2080, the current pointer location is used to determine which register is read by a read operation -- the pointer location points to the last written register address. To change the address for a read operation, a new value must be written to the pointer. This transaction is accomplished by issuing the slave address byte with the R/W bit set to '0', followed by the pointer byte. No additional data is required (refer to [Table 8-4](#)).

The master can then generate a START condition and send the slave address byte with the R/W bit set to 1 to initiate the read command. The address register is incremented automatically to enable the multibyte read and write operation (refer to [Table 8-3](#) and [Table 8-5](#)). Note that register bytes are sent MSB first, followed by the LSB. A write operation in a read-only register such as DEVICE ID, MANUFACTURER ID, or SERIAL ID returns

a NACK after each data byte. A read or write operation to an unused address returns a NACK after the pointer, and a read or write operation with incorrect I²C address returns a NACK after the I²C address.

Table 8-2. Write Single Byte

Master	START	Slave address (W)	Address	DATA	STOP
Slave			ACK	ACK	ACK

Table 8-3. Write Multi Byte

Master	START	Slave address (W)	Address	DATA	DATA	STOP
Slave			ACK	ACK	ACK	ACK	

Table 8-4. Read Single Byte

Master	START	Slave address (W)	Address	Start	Slave address (R)	NACK	STOP
Slave			ACK	ACK		ACK	DATA

Table 8-5. Read Multi Byte

Master	START	Slave address (W)	Address	Start	Slave address (R)	ACK	ACK	NACK	STOP
Slave			ACK	ACK		ACK	DATA	DATA		

8.6 Register Maps

The HDC2080 contains data registers that hold configuration information, temperature and humidity measurement results, and status information.

Table 8-6. Register Map

ADDRESS (HEX)	NAME	RESET VALUE	DESCRIPTION
0x00	TEMPERATURE LOW	00000000	Temperature [7:0]
0x01	TEMPERATURE HIGH	00000000	Temperature [15:8]
0x02	HUMIDITY LOW	00000000	Humidity [7:0]
0x03	HUMIDITY HIGH	00000000	Humidity [15:8]
0x04	INTERRUPT/DRDY	00000000	DataReady and interrupt configuration
0x05	TEMPERATURE MAX	00000000	Maximum measured temperature (Not supported in Auto Measurement Mode)
0x06	HUMIDITY MAX	00000000	Maximum measured humidity (Not supported in Auto Measurement Mode)
0x07	INTERRUPT ENABLE	00000000	Interrupt Enable
0x08	TEMP_OFFSET_ADJUST	00000000	Temperature offset adjustment
0x09	HUM_OFFSET_ADJUST	00000000	Humidity offset adjustment
0x0A	TEMP_THR_L	00000000	Temperature Threshold Low
0x0B	TEMP_THR_H	11111111	Temperature Threshold High
0x0C	RH_THR_L	00000000	Humidity threshold Low
0x0D	RH_THR_H	11111111	Humidity threshold High
0x0E	RESET&DRDY/INT CONF	00000000	Soft Reset and Interrupt Configuration
0x0F	MEASUREMENT CONFIGURATION	00000000	Measurement configuration
0xFC	MANUFACTURER ID LOW	01001001	Manufacturer ID Low
0xFD	MANUFACTURER ID HIGH	01010100	Manufacturer ID High
0xFE	DEVICE ID LOW	11010000	Device ID Low
0xFF	DEVICE ID HIGH	00001111	Device ID High

HDC2080

SNAS678C – MAY 2018 – REVISED JULY 2021

8.6.1 Address 0x00 Temperature LSB**Table 8-7. Address 0x00 Temperature LSB Register**

7	6	5	4	3	2	1	0
TEMP[7:0]							

Table 8-8. Address 0x00 Temperature LSB Field Descriptions

BIT	FIELD	TYPE	RESET	DESCRIPTION
[7:0]	TEMPERATURE [7:0]	R	00000000	Temperature LSB

8.6.2 Address 0x01 Temperature MSB

The temperature register is a 16-bit result register in binary format (the 2 LSBs D1 and D0 are always 0). The result of the acquisition is always a 14-bit value, while the resolution is related to one selected in Measurement Configuration register. The temperature must be read LSB first.

Table 8-9. Address 0x01 Temperature MSB Register

7	6	5	4	3	2	1	0
TEMP[15:8]							

Table 8-10. Address 0x01 Temperature MSB Field Descriptions

BIT	FIELD	TYPE	RESET	DESCRIPTION
[15:8]	TEMPERATURE [15:8]	R	00000000	Temperature MSB

The temperature can be calculated from the output data with [Equation 1](#):

$$\text{Temperature (}^{\circ}\text{C)} = \left(\frac{\text{TEMPERATURE [15:0]}}{2^{16}} \right) \times 165 - 40.5 \quad (1)$$

For highest accuracy, correction for a slight PSRR sensitivity should be applied to [Equation 1](#) for supplies > 1.8 V which results in [Equation 2](#).

$$\text{Temperature (}^{\circ}\text{C)} = \left(\frac{\text{TEMPERATURE[15:0]}}{2^{16}} \right) \times 165 - (40.5 + \text{TEMP}_{\text{PSRR}} \times (V_{\text{DD}} - 1.8 \text{ V})) \quad (2)$$

8.6.3 Address 0x02 Humidity LSB

Table 8-11. Address 0x02 Humidity LSB Register

7	6	5	4	3	2	1	0
HUMIDITY[7:0]							

Table 8-12. Address 0x02 Humidity LSB Field Descriptions

BIT	FIELD	TYPE	RESET	DESCRIPTION
[7:0]	HUMIDITY [7:0]	R	00000000	Humidity LSB

8.6.4 Address 0x03 Humidity MSB

The humidity register is a 16-bit result register in binary format (the 2 LSBs D1 and D0 are always 0). The result of the acquisition is always a 14 bit value, while the resolution is related to one selected in Measurement Configuration register. The humidity measurement must be read LSB first.

Table 8-13. Address 0x03 Humidity MSB Register

7	6	5	4	3	2	1	0
HUMIDITY[15:8]							

Table 8-14. Address 0x03 Temperature MSB Field Descriptions

BIT	FIELD	TYPE	RESET	DESCRIPTION
[15:8]	HUMIDITY[15:8]	R	00000000	Humidity MSB

The humidity can be calculated from the output data with [Equation 3](#):

$$\text{Humidity (\%RH)} = \left(\frac{\text{HUMIDITY [15 : 0]}}{2^{16}} \right) \times 100 \quad (3)$$

HDC2080

SNAS678C – MAY 2018 – REVISED JULY 2021

8.6.5 Address 0x04 Interrupt DRDY**Table 8-15. Address 0x04 Interrupt DRDY Register**

7	6	5	4	3	2	1	0
DRDY_STATUS	TH_STATUS	TL_STATUS	HH_STATUS	HL_STATUS	RES	RES	RES

Table 8-16. Address 0x04 Interrupt DRDY Field Descriptions

BIT	FIELD	TYPE	RESET	DESCRIPTION
7	DRDY_STATUS	R/W	0	DataReady bit status 0 = Data Not Ready 1 = Data Ready DRDY_STATUS is cleared to 0 when read
6	TH_STATUS	R/W	0	Temperature threshold HIGH Interrupt status 0 = No interrupt 1 = Interrupt TH_STATUS is cleared to 0 when read
5	TL_STATUS	R/W	0	Temperature threshold LOW Interrupt status 0 = No interrupt 1 = Interrupt TL_STATUS is cleared to 0 when read
4	HH_STATUS	R/W	0	Humidity threshold HIGH Interrupt status 0 = No interrupt 1 = Interrupt HH_STATUS is cleared to 0 when read
3	HL_STATUS	R/W	0	Humidity threshold LOW Interrupt status 0 = No interrupt 1 = Interrupt HL_STATUS is cleared to 0 when read
2	RES		0	Reserved
1	RES		0	Reserved
0	RES		0	Reserved

DRDY_STATUS indicates that temperature and/or humidity conversion is terminated. This bit is cleared when the Interrupt/DRDY register is read or the output registers TEMPERATURE_HIGH, TEMPERATURE_LOW, HUMIDITY_HIGH and HUMIDITY_LOW are read.

The TL_STATUS indicates that the *Temperature Threshold LOW* value is exceeded. The behavior is defined by 0x0E Configuration register value. The bit is cleared when the register Interrupt DRDY is read.

The TH_STATUS indicates that the *Temperature Threshold HIGH* value is exceeded. The behavior is defined by 0x0E Configuration register value. The bit is cleared when the register Interrupt DRDY is read.

The HH_STATUS indicates that the *Humidity Threshold HIGH* value is exceeded. The behavior is defined by 0x0E Configuration register value. The bit is cleared when the register Interrupt DRDY is read.

The HL_STATUS indicates that the *Humidity Threshold LOW* value is exceeded. The behavior is defined by 0x0E Configuration register value. The bit is cleared when the register Interrupt DRDY is read.

DRDY/INT pin behaves like the STATUS bits based on the 0x0E Configuration register value.

8.6.6 Address 0x05 Temperature MAX

This register implements temperature peak detector function. It stores the highest temperature value converted after the power up. Value is reset at power up and/or with soft reset procedure.

Table 8-17. Address 0x05 Temperature MAX Register

7	6	5	4	3	2	1	0
TEMPERATUREMAX[7:0]							

Table 8-18. Address 0x05 Temperature Max Field Descriptions

BIT	FIELD	TYPE	RESET	DESCRIPTION
[7:0]	TEMPERATUREMAX[7:0]	R/W	00000000	Stores maximum temperature measurement from all I ² C read requests for temperature Not supported in Auto Measurement Mode

The temperature can be calculated from the output data with [Equation 4](#):

$$\text{Temperature Max (}^{\circ}\text{C)} = \left(\frac{\text{TEMPERATUREMAX [7 : 0]}}{2^8} \right) \times 165 - 40.5 \quad (4)$$

For highest accuracy, correction for a slight PSRR sensitivity should be applied to [Equation 4](#) for supplies > 1.8 V which results in [Equation 5](#).

$$\text{Temperature Max (}^{\circ}\text{C)} = \left(\frac{\text{TEMPERATUREMAX[7:0]}}{2^8} \right) \times 165 - (40.5 + \text{TEMP}_{\text{PSRR}} \times (\text{V}_{\text{DD}} - 1.8 \text{ V})) \quad (5)$$

8.6.7 Address 0x06 Humidity MAX

This register implements humidity peak detector function. It stores the highest humidity value converted after the power up. Value is reset at power up and/or with soft reset procedure.

Table 8-19. Address 0x06 Humidity MAX Register

7	6	5	4	3	2	1	0
HUMIDITYMAX[7:0]							

Table 8-20. Address 0x06 Humidity MAX Field Descriptions

BIT	FIELD	TYPE	RESET	DESCRIPTION
[7:0]	HUMIDITYMAX[7:0]	R/W	00000000	Stores maximum humidity measurement from all I ² C read requests for humidity Not supported in Auto Measurement Mode

The humidity can be calculated from the output data with [Equation 6](#):

$$\text{Humidity (\%RH)} = \text{HUMIDITYMAX[7 : 0]} \times \left(\frac{100}{2^8} \right) \quad (6)$$

HDC2080

SNAS678C – MAY 2018 – REVISED JULY 2021

8.6.8 Address 0x07 Interrupt Configuration**Table 8-21. Address 0x07 Interrupt Configuration Register**

7	6	5	4	3	2	1	0
DRDY_ENABLE	TH_ENABLE	TL_ENABLE	HH_ENABLE	HL_ENABLE	RES	RES	RES

Table 8-22. Address 0x07 Interrupt Configuration Field Descriptions

BIT	FIELD	TYPE	RESET	DESCRIPTION
7	DRDY_ENABLE	R/W	0	DataReady Interrupt enable 0 = DataReady Interrupt generator disable 1 = DataReady Interrupt generator enable
6	TH_ENABLE	R/W	0	Temperature threshold HIGH Interrupt enable 0 = Temperature high Interrupt generator disable 1 = Temperature high Interrupt generator enable
5	TL_ENABLE	R/W	0	Temperature threshold LOW Interrupt enable 0 = Temperature low Interrupt generator disable 1 = Temperature low Interrupt generator enable
4	HH_ENABLE	R/W	0	Humidity threshold HIGH Interrupt enable 0 = Humidity high Interrupt generator disable 1 = Humidity high Interrupt generator enable
3	HL_ENABLE	R/W	0	Humidity threshold LOW Interrupt enable 0 = Humidity low Interrupt generator disable 1 = Humidity low Interrupt generator enable
2	RES		0	Reserved
1	RES		0	Reserved
0	RES		0	Reserved

8.6.9 Address 0x08 Temperature Offset Adjustment

Table 8-23. Address 0x08 Temperature Offset Adjustment Register

7	6	5	4	3	2	1	0
TEMP_OFFSET_ADJUST[7:0]							

Table 8-24. Address 0x08 Temperature Offset Adjustment Field Descriptions

BIT	FIELD	TYPE	RESET	DESCRIPTION
[7:0]	TEMP_OFFSET_ADJUST [7:0]	R/W	00000000	Temperature offset adjustment. Added to the converted Temperature value

The temperature can be adjusted adding the following values that are enable settings the equivalents bits:

7	6	5	4	3	2	1	0
-20.62°C	+10.32°C	+5.16°C	+2.58°C	+1.28°C	+0.64°C	+0.32°C	+0.16°C

The value is added to the converted temperature value for offset adjustment as shown in [Figure 8-7](#)

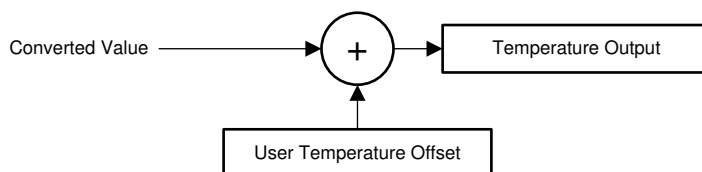

Figure 8-7. Temperature Output Calculation

The resulting temperature offset is a summation of the register bits that have been enabled (that is, programmed to 1). Some examples:

1. Programming TEMP_OFFSET_ADJUST to 00000001 adjusts the reported temperature by +0.16°C.
2. Programming TEMP_OFFSET_ADJUST to 00000111 adjusts the reported temperature by +1.12°C.
3. Programming TEMP_OFFSET_ADJUST to 00001101 adjusts the reported temperature by +2.08°C.
4. Programming TEMP_OFFSET_ADJUST to 11111111 adjusts the reported temperature by -0.16°C.
5. Programming TEMP_OFFSET_ADJUST to 11111001 adjusts the reported temperature by -1.12°C.
6. Programming TEMP_OFFSET_ADJUST to 11110011 adjusts the reported temperature by -2.08°C.

HDC2080

SNAS678C – MAY 2018 – REVISED JULY 2021

8.6.10 Address 0x09 Humidity Offset Adjustment**Table 8-25. Address 0x09 Humidity Offset Adjustment Register**

7	6	5	4	3	2	1	0
HUM_OFFSET_ADJUST [7:0]							

Table 8-26. Address 0x09 Humidity Offset Adjustment Field Descriptions

BIT	FIELD	TYPE	RESET	DESCRIPTION
[7:0]	HUM_OFFSET_ADJUST [7:0]	R/W	00000000	Humidity offset adjustment. Added to the converted Humidity value

The humidity can be adjusted adding the following values that are enable settings the equivalents bits:

7	6	5	4	3	2	1	0
-25%RH	+12.5%RH	+6.3%RH	+3.1%RH	+1.6%RH	+0.8%RH	+0.4%RH	+0.2%RH

The value is added to the converted temperature value for offset adjustment as shown in [Figure 8-8](#)

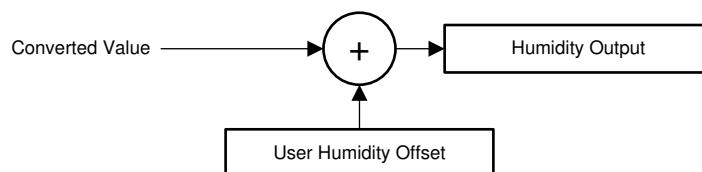
**Figure 8-8. Humidity Output Calculation**

The resulting humidity offset is a summation of the register bits that have been enabled (i.e. programmed to 1). Some examples:

1. Programming HUM_OFFSET_ADJUST to 00000001 adjusts the reported humidity by +0.20%RH.
2. Programming HUM_OFFSET_ADJUST to 00000101 adjusts the reported humidity by +1.00%RH.
3. Programming HUM_OFFSET_ADJUST to 00001010 adjusts the reported humidity by +2.00%RH.
4. Programming HUM_OFFSET_ADJUST to 11111111 adjusts the reported humidity by -0.10%RH.
5. Programming HUM_OFFSET_ADJUST to 11111011 adjusts the reported humidity by -0.90%RH.
6. Programming HUM_OFFSET_ADJUST to 11110101 adjusts the reported humidity by -2.10%RH.

8.6.11 Address 0x0A Temperature Threshold LOW

Table 8-27. Address 0x0A Temperature Threshold LOW Register

7	6	5	4	3	2	1	0
TEMP_THRES_LOW[7:0]							

Table 8-28. Address 0x0A Temperature Threshold LOW Field Descriptions

BIT	FIELD	TYPE	RESET	DESCRIPTION
[7:0]	TEMP_THRES_LOW[7:0]	R/W	00000000	Temperature threshold LOW value

The Temperature Threshold LOW can be calculated from the output data with [Equation 7](#):

$$\text{Temperature threshold low (}^{\circ}\text{C)} = \left(\frac{\text{TEMP_THRES_LOW [7:0]}}{2^8} \right) \times 165 - 40.5 \quad (7)$$

For highest accuracy, correction for a slight PSRR sensitivity should be applied to [Equation 7](#) for supplies > 1.8 V which results in [Equation 8](#).

$$\text{Temperature threshold low (}^{\circ}\text{C)} = \left(\frac{(\text{TEMP_THRES_LOW}[7:0])}{2^8} \right) \times 165 - (40.5 + \text{TEMP}_{\text{PSRR}} \times (V_{\text{DD}} - 1.8 \text{ V})) \quad (8)$$

8.6.12 Address 0x0B Temperature Threshold HIGH

Table 8-29. Address 0x0B Temperature Threshold HIGH Register

7	6	5	4	3	2	1	0
TEMP_THRES_HIGH[7:0]							

Table 8-30. Address 0x0B Temperature Threshold HIGH Field Descriptions

BIT	FIELD	TYPE	RESET	DESCRIPTION
[7:0]	TEMP_THRES_HIGH[7:0]	R/W	11111111	Temperature threshold HIGH value

The Temperature Threshold HIGH can be calculated from the output data with [Equation 9](#):

$$\text{Temperature threshold high (}^{\circ}\text{C)} = \left(\frac{\text{TEMP_THRES_HIGH [7:0]}}{2^8} \right) \times 165 - 40.5 \quad (9)$$

For highest accuracy, correction for a slight PSRR sensitivity should be applied to [Equation 9](#) for supplies > 1.8 V which results in [Equation 10](#).

$$\text{Temperature threshold high (}^{\circ}\text{C)} = \left(\frac{(\text{TEMP_THRES_HIGH}[7:0])}{2^8} \right) \times 165 - (40.5 + \text{TEMP}_{\text{PSRR}} \times (V_{\text{DD}} - 1.8 \text{ V})) \quad (10)$$

HDC2080

SNAS678C – MAY 2018 – REVISED JULY 2021

8.6.13 Address 0x0C Humidity Threshold LOW**Table 8-31. Address 0x0C Humidity Threshold LOW Register**

7	6	5	4	3	2	1	0
HUMI_THRES_LOW[7:0]							

Table 8-32. Address 0x0C Humidity Threshold LOW Field Descriptions

BIT	FIELD	TYPE	RESET	DESCRIPTION
[7:0]	HUMI_THRES_LOW[7:0]	R/W	00000000	Humidity threshold LOW value

The Humidity Threshold LOW can be calculated from the output data with [Equation 11](#):

$$\text{Humidity threshold low (\%RH)} = \left(\frac{\text{HUMI_THRES_LOW}[7:0]}{2^8} \right) \times 100 \quad (11)$$

8.6.14 Address 0x0D Humidity Threshold HIGH**Table 8-33. Address 0x0D Humidity Threshold HIGH Register**

7	6	5	4	3	2	1	0
HUMI_THRES_HIGH[7:0]							

Table 8-34. Address 0x0D Humidity Threshold HIGH Field Descriptions

BIT	FIELD	TYPE	RESET	DESCRIPTION
[7:0]	HUMI_THRES_HIGH[7:0]	R/W	11111111	Humidity threshold HIGH value

The Humidity Threshold HIGH can be calculated from the output data with [Equation 12](#):

$$\text{Humidity threshold high (\%RH)} = \left(\frac{\text{HUMI_THRES_HIGH}[7:0]}{2^8} \right) \times 100 \quad (12)$$

8.6.15 Address 0x0E Reset and DRDY/INT Configuration Register

Table 8-35. Address 0x0E Configuration Register

7	6	5	4	3	2	1	0
SOFT_RES	AMM[2]	AMM[1]	AMM[0]	HEAT_EN	DRDY/INT_EN	INT_POL	INT_MODE

Table 8-36. Address 0x0E Configuration Field Descriptions

BIT	FIELD	TYPE	RESET	DESCRIPTION
7	SOFT_RES	R/W	0	0 = Normal Operation mode, this bit is self-clear 1 = Soft Reset EEPROM value reload and registers reset
[6:4]	AMM[2:0]	R/W	000	Auto Measurement Mode (AMM) 000 = Disabled. Initiate measurement via I ² C 001 = 1/120Hz (1 samples every 2 minutes) 010 = 1/60Hz (1 samples every minute) 011 = 0.1Hz (1 samples every 10 seconds) 100 = 0.2 Hz (1 samples every 5 second) 101 = 1Hz (1 samples every second) 110 = 2Hz (2 samples every second) 111 = 5Hz (5 samples every second)
3	HEAT_EN	R/W	0	0 = Heater off 1 = Heater on
2	DRDY/INT_EN	R/W	0	DRDY/INT_EN pin configuration 0 = High Z 1 = Enable
1	INT_POL	R/W	0	Interrupt polarity 0 = Active Low 1 = Active High
0	INT_MODE	R/W	0	Interrupt mode 0 = Level sensitive 1 = Comparator mode

HDC2080

SNAS678C – MAY 2018 – REVISED JULY 2021

8.6.16 Address 0x0F Measurement Configuration**Table 8-37. Address 0x0F Measurement Configuration Register**

7	6	5	4	3	2	1	0
TRES[1]	TRES[0]	HRES[1]	HRES[0]	RES	MEAS_CONF[1]	MEAS_CONF[0]	MEAS_TRIG

Table 8-38. Address 0x0F Measurement Configuration Field Descriptions

BIT	FIELD	TYPE	RESET	DESCRIPTION
7:6	TRES[1:0]	R/W	00	Temperature resolution 00: 14 bit 01: 11 bit 10: 9 bit 11: NA
5:4	HRES[1:0]	R/W	00	Humidity resolution 00: 14 bit 01: 11 bit 10: 9 bit 11: NA
3	RES	R/W	0	Reserved
2:1	MEAS_CONF[1:0]	R/W	00	Measurement configuration 00: Humidity + Temperature 01: Temperature only 10: NA 11: NA
0	MEAS_TRIG	R/W	0	Measurement trigger 0: no action 1: Start measurement Self-clearing bit when measurement completed

8.6.17 Manufacturer ID Low**Table 8-39. Manufacturer ID Low Register**

7	6	5	4	3	2	1	0
MANUFACTURER ID[7:0]							

Table 8-40. Address 0xFC Manufacturer ID Low Field Descriptions

BIT	FIELD	TYPE	RESET	DESCRIPTION
[7:0]	MANUFACTURER ID [7:0]	R	01001001	Manufacturer ID LOW value

8.6.18 Manufacturer ID High

These registers contain a factory-programmable identification value that identifies this device as being manufactured by Texas Instruments. These registers distinguish this device from other devices that are on the same I²C bus. The manufacturer ID reads 0x4954

Table 8-41. Manufacturer ID High Register

7	6	5	4	3	2	1	0
MANUFACTURER ID[15:8]							

Table 8-42. Address 0xFD Manufacturer ID High Field Descriptions

BIT	FIELD	TYPE	RESET	DESCRIPTION
[7:0]	MANUFACTURER ID [15:8]	R	01010100	Manufacturer ID HIGH value

8.6.19 Device ID Low

Table 8-43. Device ID Low Register

7	6	5	4	3	2	1	0
DEVICE ID[7:0]							

Table 8-44. Address 0xFE Device ID Low Field Descriptions

BIT	FIELD	TYPE	RESET	DESCRIPTION
[7:0]	DEVICE ID [7:0]	R	11010000	Device ID LOW value

8.6.20 Device ID High

These registers contain a factory-programmable identification value that identifies this device as a HDC2080. These registers distinguish this device from other devices that are on the same I²C bus. The Device ID for the HDC2080 is 0x07D0

Table 8-45. Device ID High Register

7	6	5	4	3	2	1	0
DEVICE ID[15:8]							

Table 8-46. Address 0xFF Device ID High Field Descriptions

BIT	FIELD	TYPE	RESET	DESCRIPTION
[7:0]	DEVICE ID [15:8]	R	00000111	Device ID HIGH value

HDC2080

SNAS678C – MAY 2018 – REVISED JULY 2021

9 Application and Implementation**Note**

Information in the following applications sections is not part of the TI component specification, and TI does not warrant its accuracy or completeness. TI's customers are responsible for determining suitability of components for their purposes, as well as validating and testing their design implementation to confirm system functionality.

9.1 Application Information

An HVAC system thermostat control is based on environmental sensors and a microcontroller. The microcontroller acquires data from humidity and temperature sensors and controls the heating and cooling system. The collected data are then shown on a display that can be easily controlled by the microcontroller. Based on data from the humidity and temperature sensor, the heating and cooling system then maintains the environment at the customer-defined preferred conditions.

9.2 Typical Application

In a battery-powered HVAC system thermostat, one of the key parameters in the selection of components is the power consumption. The HDC2080, with 550 nA of current consumption (the average consumption over 1s for RH and Temperature measurements), in conjunction with a MSP430, represents one way an engineer can obtain low power consumption and extend battery life. A system block diagram of a battery-powered thermostat is shown in [Figure 9-1](#).

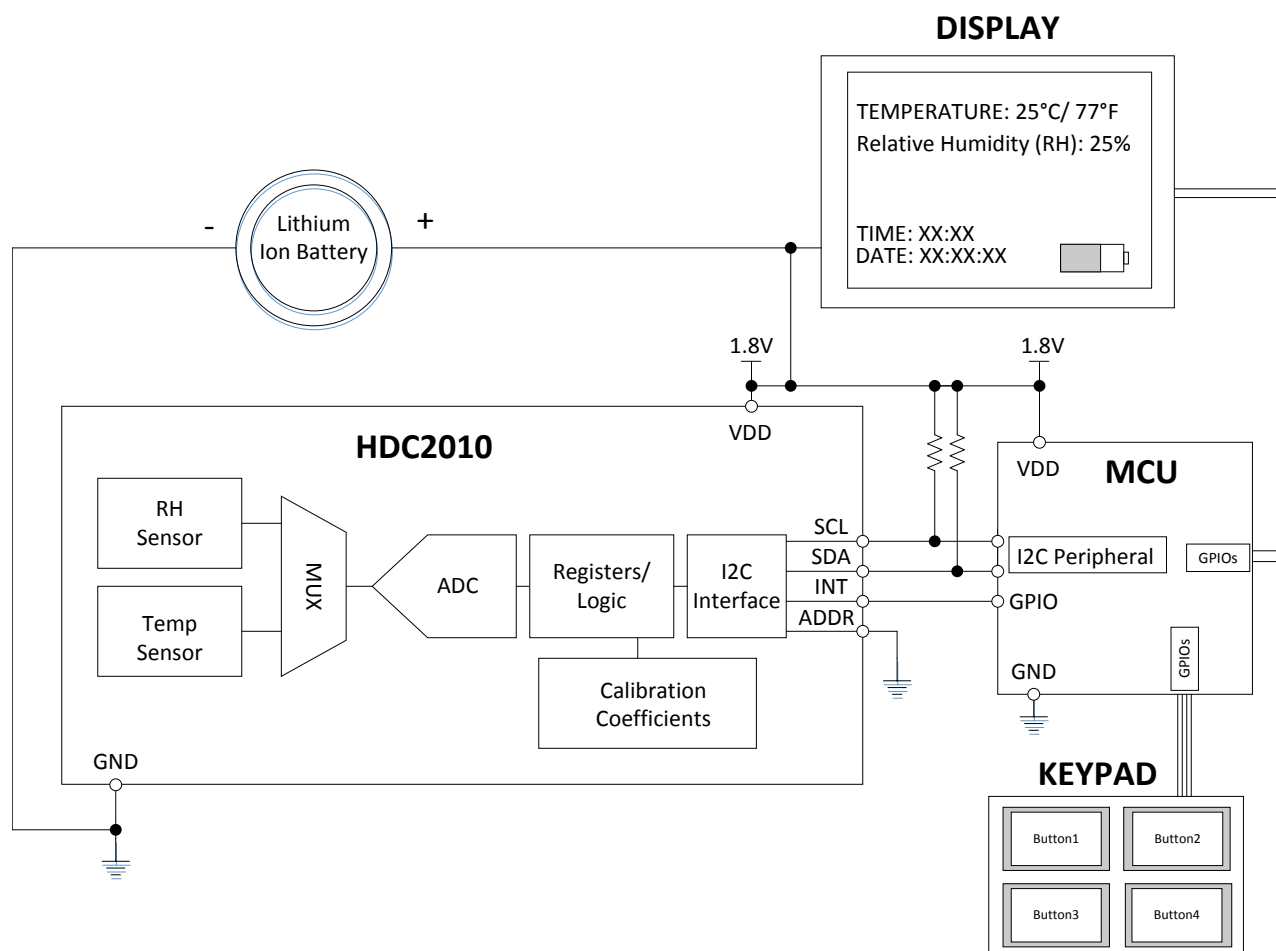
**Figure 9-1. Typical Application Schematic HVAC**

9.2.1 Design Requirements

To improve measurement accuracy, TI recommends to isolate the HDC2080 from all heat sources in the form of active circuitry, batteries, displays and resistive elements. If design space is a constraint, cutouts surrounding the device or the inclusion of small trenches can help minimize heat transfer from PCB heat sources to the HDC2080. To avoid self-heating the HDC2080, TI recommends to configure the device for a maximum sample rate of 1 Hz (1sps).

9.2.2 Detailed Design Procedure

When a circuit board layout is created from the schematic shown in [Figure 9-1](#), a small circuit board is possible. The accuracy of a RH and temperature measurement depends on the sensor accuracy and the setup of the sensing system. The HDC2080 samples relative humidity and temperature in its immediate environment, it is therefore important that the local conditions at the sensor match the monitored environment. Use one or more openings in the physical cover of the thermostat to obtain a good airflow even in static conditions. Refer to the layout ([Figure 11-2](#)) for a PCB layout which minimizes the thermal mass of the PCB in the region of the HDC2080, which can improve measurement response time and accuracy.

9.2.3 Application Curve

These results were acquired at $T_A = 30^\circ\text{C}$ using a humidity chamber that sweeps RH%. The sweep profile used was 20% > 30% > 40% > 50% > 60% > 70% > 60% > 50% > 40% > 30% > 20%. Each RH% set point was held for 20 minutes.

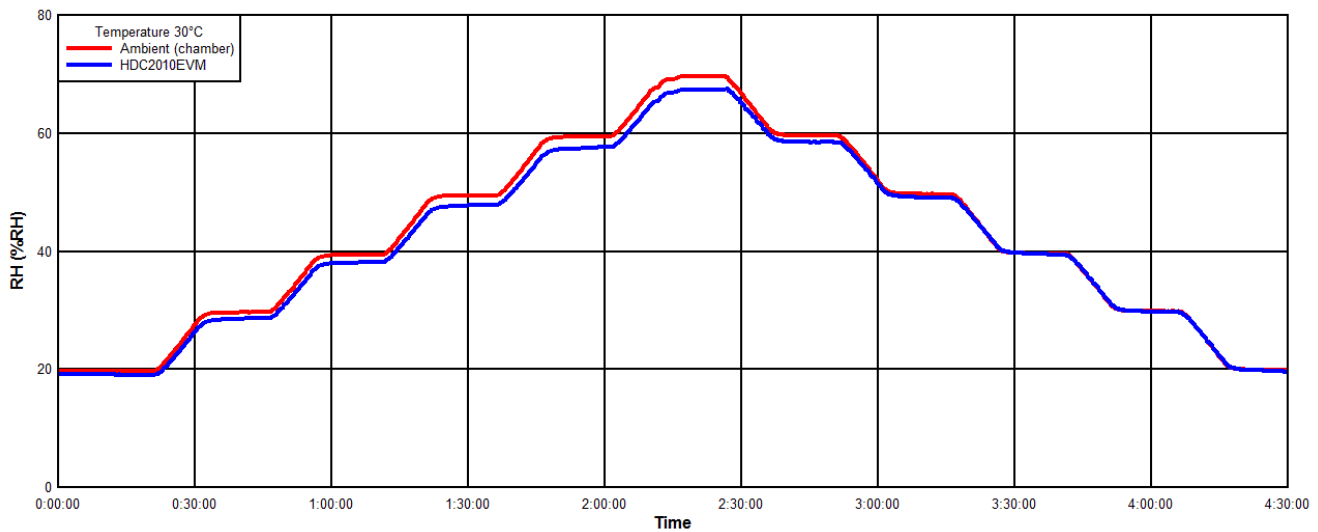

Figure 9-2. RH% Readings of Chamber and HDC2080 vs. Time

10 Power Supply Recommendations

The HDC2080 requires a voltage supply within 1.62 V and 3.60 V. TI recommends a multilayer ceramic bypass X7R capacitor of 0.1 μ F between the VDD and GND pins.

11 Layout

11.1 Layout Guidelines

The HDC2080's relative humidity-sensing element is located on the top side of the package.

TI recommends that the user eliminate the copper layers below the device (GND, V_{DD}) and create slots in the PCB around the device to enhance the thermal isolation of the HDC2080. To ensure the temperature sensor performance, TI highly recommends that the user follow the Land Pattern, Solder Mask, and Solder Paste examples depicted in the [Section 13](#).

11.1.1 Guidelines for HDC2080 Storage and PCB Assembly

11.1.1.1 Storage and Handling

As with all humidity sensors, the HDC2080 must follow special guidelines regarding handling and storage that are not common with standard semiconductor devices. Long exposure to UV and visible light, or exposure to chemical vapors for prolonged periods, should be avoided as it may affect RH% accuracy. Additionally, the device should be protected from out-gassed solvent vapors produced during manufacturing, transport, operation, and package materials (that is, adhesive tapes, stickers, bubble foils). For further detailed information, see [HDC20xx Silicon User's Guide](#)(SNAU250)

11.1.1.2 Soldering Reflow

For PCB assembly, standard reflow soldering ovens may be used. The HDC2080 uses the standard soldering profile IPC/JEDEC J-STD-020 with peak temperatures at 260°C. When soldering the HDC2080, it is mandatory to use *no-clean* solder paste, and the paste must not be exposed to water or solvent rinses during assembly because these contaminants may affect sensor accuracy. After reflow, it is expected that the sensor will generally output a shift in relative humidity, which will reduce over time as the sensor is exposed to typical indoor ambient conditions. These conditions include 30-40% RH at room temperature during a duration of several days. Following this re-hydration procedure allows the polymer to correctly settle after reflow and return to the calibrated RH accuracy.

11.1.1.3 Rework

TI recommends to limit the HDC2080 to a single IR reflow with no rework, but a second reflow may be possible if the following guidelines are met:

- The exposed polymer (humidity sensor) is kept clean and undamaged.
- The no-clean solder paste is used and the process is not exposed to any liquids, such as water or solvents.
- The Peak soldering temperature does not exceed 260°C.

11.1.1.4 High Temperature and Humidity Exposure

Long exposure outside the recommended operating conditions may temporarily offset the RH output. To maintain the highest accuracy, the recommended humidity operating range is 20 to 80% RH (non-condensing) over 0 to 70°C. Prolonged operation beyond these ranges, particularly high RH and high temperature, may shift the sensor reading with a slow recovery time.

When the sensor is exposed to wider humidity and temperature conditions for a short period, [Figure 11-1](#) shows the typical relative humidity accuracy across combinations of temperature and relative humidity.

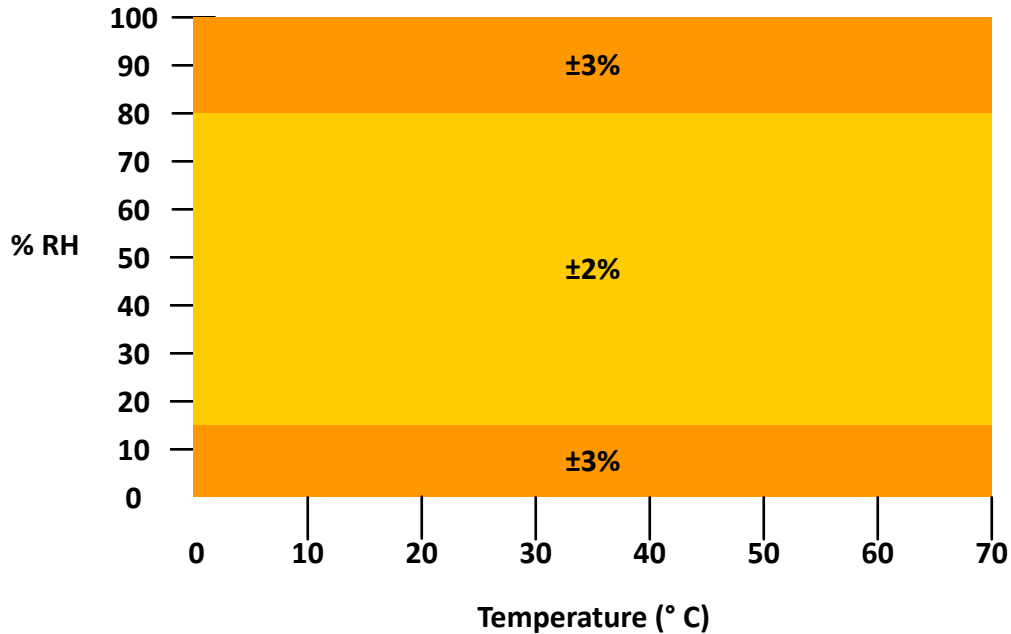

Figure 11-1. Typical Relative Humidity Accuracy Range Limits

11.1.1.5 Bake/Re-Hydration Procedure

Prolonged exposure to extreme conditions or harsh contaminants may impact sensor performance. In the case that permanent offset is observed from contaminants, the following procedure is suggested, which may recover or reduce the error observed in sensor performance:

1. Baking: 100°C, at less than 5%RH, for 5 to 10 hours
2. Re-hydration: Between 20°C to 30°C, 60%RH to 75%RH, for 6 to 12 hours

12 Device and Documentation Support

12.1 Documentation Support

12.1.1 Related Documentation

For related documentation, see the following:

- Texas Instruments, [Humidity Sensor: Storage and Handling Guidelines](#). (SNIA025)
- Texas Instruments, [Optimizing Placement and Routing for Humidity Sensors application report](#) (SNAA297)

12.2 Receiving Notification of Documentation Updates

To receive notification of documentation updates, navigate to the device product folder on [ti.com](#). Click on *Subscribe to updates* to register and receive a weekly digest of any product information that has changed. For change details, review the revision history included in any revised document.

12.3 Support Resources

[TI E2E™ support forums](#) are an engineer's go-to source for fast, verified answers and design help — straight from the experts. Search existing answers or ask your own question to get the quick design help you need.

Linked content is provided "AS IS" by the respective contributors. They do not constitute TI specifications and do not necessarily reflect TI's views; see TI's [Terms of Use](#).

12.4 Trademarks

TI E2E™ is a trademark of Texas Instruments.

All trademarks are the property of their respective owners.

12.5 Electrostatic Discharge Caution



This integrated circuit can be damaged by ESD. Texas Instruments recommends that all integrated circuits be handled with appropriate precautions. Failure to observe proper handling and installation procedures can cause damage.

ESD damage can range from subtle performance degradation to complete device failure. Precision integrated circuits may be more susceptible to damage because very small parametric changes could cause the device not to meet its published specifications.

12.6 Glossary

[TI Glossary](#) This glossary lists and explains terms, acronyms, and definitions.

13 Mechanical, Packaging, and Orderable Information

The following pages include mechanical, packaging, and orderable information. This information is the most current data available for the designated devices. This data is subject to change without notice and revision of this document. For browser-based versions of this data sheet, refer to the left-hand navigation.

PACKAGING INFORMATION

Orderable part number	Status (1)	Material type (2)	Package Pins	Package qty Carrier	RoHS (3)	Lead finish/ Ball material (4)	MSL rating/ Peak reflow (5)	Op temp (°C)	Part marking (6)
HDC2080DMBR	Active	Production	WSON (DMB) 6	3000 LARGE T&R	Yes	NIPDAU	Level-1-260C-UNLIM	-40 to 125	3C
HDC2080DMBR.A	Active	Production	WSON (DMB) 6	3000 LARGE T&R	Yes	NIPDAU	Level-1-260C-UNLIM	-40 to 125	3C

(1) **Status:** For more details on status, see our [product life cycle](#).

(2) **Material type:** When designated, preproduction parts are prototypes/experimental devices, and are not yet approved or released for full production. Testing and final process, including without limitation quality assurance, reliability performance testing, and/or process qualification, may not yet be complete, and this item is subject to further changes or possible discontinuation. If available for ordering, purchases will be subject to an additional waiver at checkout, and are intended for early internal evaluation purposes only. These items are sold without warranties of any kind.

(3) **RoHS values:** Yes, No, RoHS Exempt. See the [TI RoHS Statement](#) for additional information and value definition.

(4) **Lead finish/Ball material:** Parts may have multiple material finish options. Finish options are separated by a vertical ruled line. Lead finish/Ball material values may wrap to two lines if the finish value exceeds the maximum column width.

(5) **MSL rating/Peak reflow:** The moisture sensitivity level ratings and peak solder (reflow) temperatures. In the event that a part has multiple moisture sensitivity ratings, only the lowest level per JEDEC standards is shown. Refer to the shipping label for the actual reflow temperature that will be used to mount the part to the printed circuit board.

(6) **Part marking:** There may be an additional marking, which relates to the logo, the lot trace code information, or the environmental category of the part.

Multiple part markings will be inside parentheses. Only one part marking contained in parentheses and separated by a "-" will appear on a part. If a line is indented then it is a continuation of the previous line and the two combined represent the entire part marking for that device.

Important Information and Disclaimer:The information provided on this page represents TI's knowledge and belief as of the date that it is provided. TI bases its knowledge and belief on information provided by third parties, and makes no representation or warranty as to the accuracy of such information. Efforts are underway to better integrate information from third parties. TI has taken and continues to take reasonable steps to provide representative and accurate information but may not have conducted destructive testing or chemical analysis on incoming materials and chemicals. TI and TI suppliers consider certain information to be proprietary, and thus CAS numbers and other limited information may not be available for release.

In no event shall TI's liability arising out of such information exceed the total purchase price of the TI part(s) at issue in this document sold by TI to Customer on an annual basis.

TAPE AND REEL INFORMATION

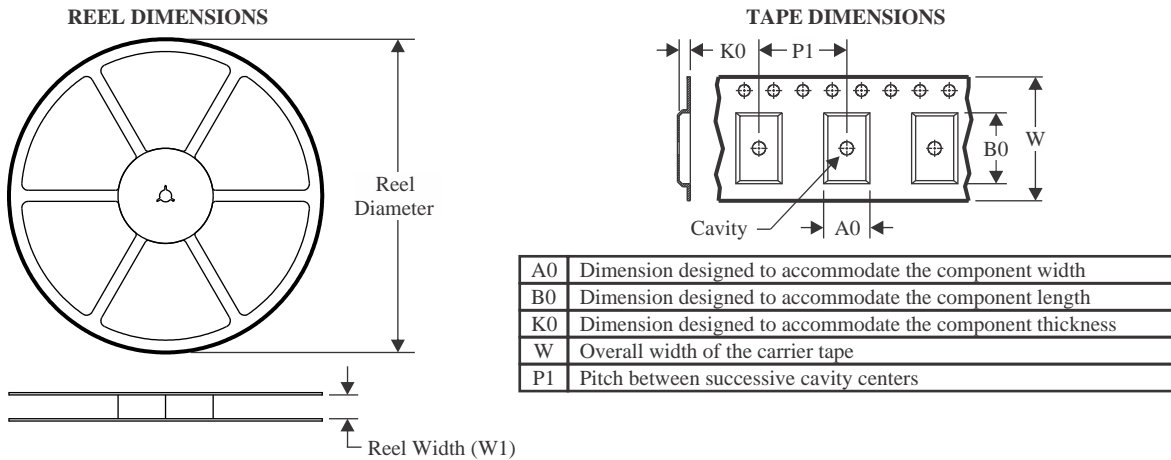

QUADRANT ASSIGNMENTS FOR PIN 1 ORIENTATION IN TAPE

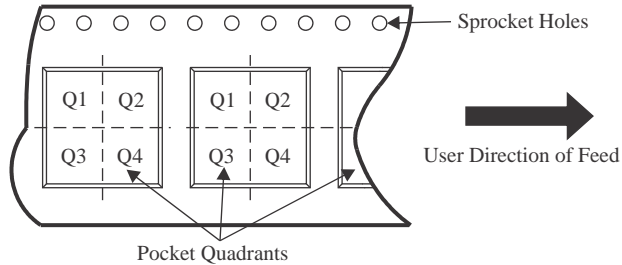

*All dimensions are nominal

Device	Package Type	Package Drawing	Pins	SPQ	Reel Diameter (mm)	Reel Width W1 (mm)	A0 (mm)	B0 (mm)	K0 (mm)	P1 (mm)	W (mm)	Pin1 Quadrant
HDC2080DMBR	WSON	DMB	6	3000	330.0	15.4	3.3	3.3	1.1	8.0	12.0	Q2

TAPE AND REEL BOX DIMENSIONS

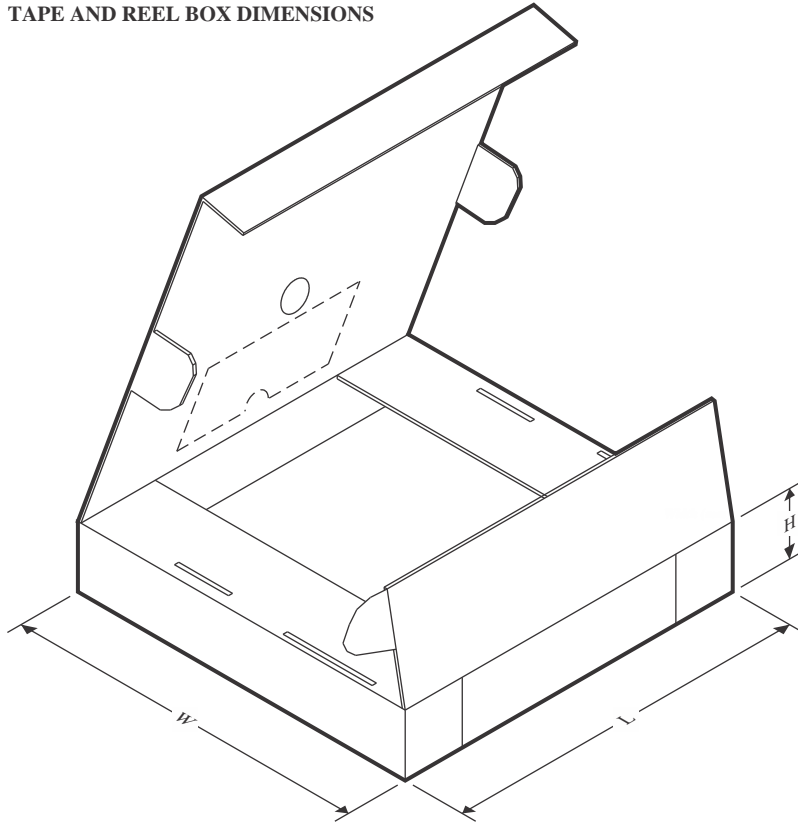

*All dimensions are nominal

Device	Package Type	Package Drawing	Pins	SPQ	Length (mm)	Width (mm)	Height (mm)
HDC2080DMBR	WSON	DMB	6	3000	335.0	335.0	32.0

GENERIC PACKAGE VIEW

DMB 6

WSO_N - 0.8 mm max height

PLASTIC SMALL OUTLINE - NO LEAD

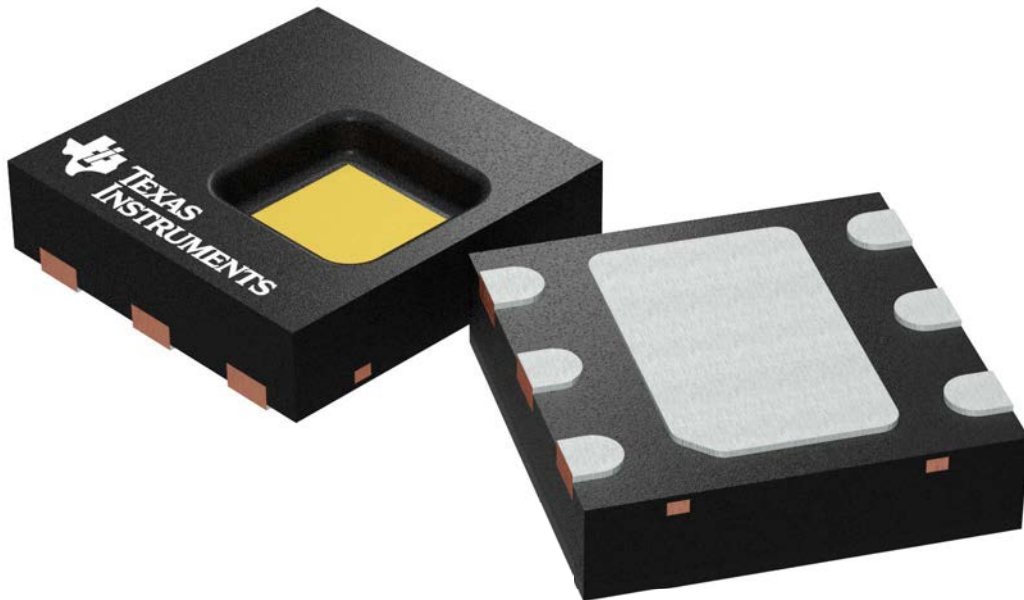

Images above are just a representation of the package family, actual package may vary.
Refer to the product data sheet for package details.



DMB0006A

PACKAGE OUTLINE

WSON - 0.8 mm max height

PLASTIC SMALL OUTLINE - NO LEAD

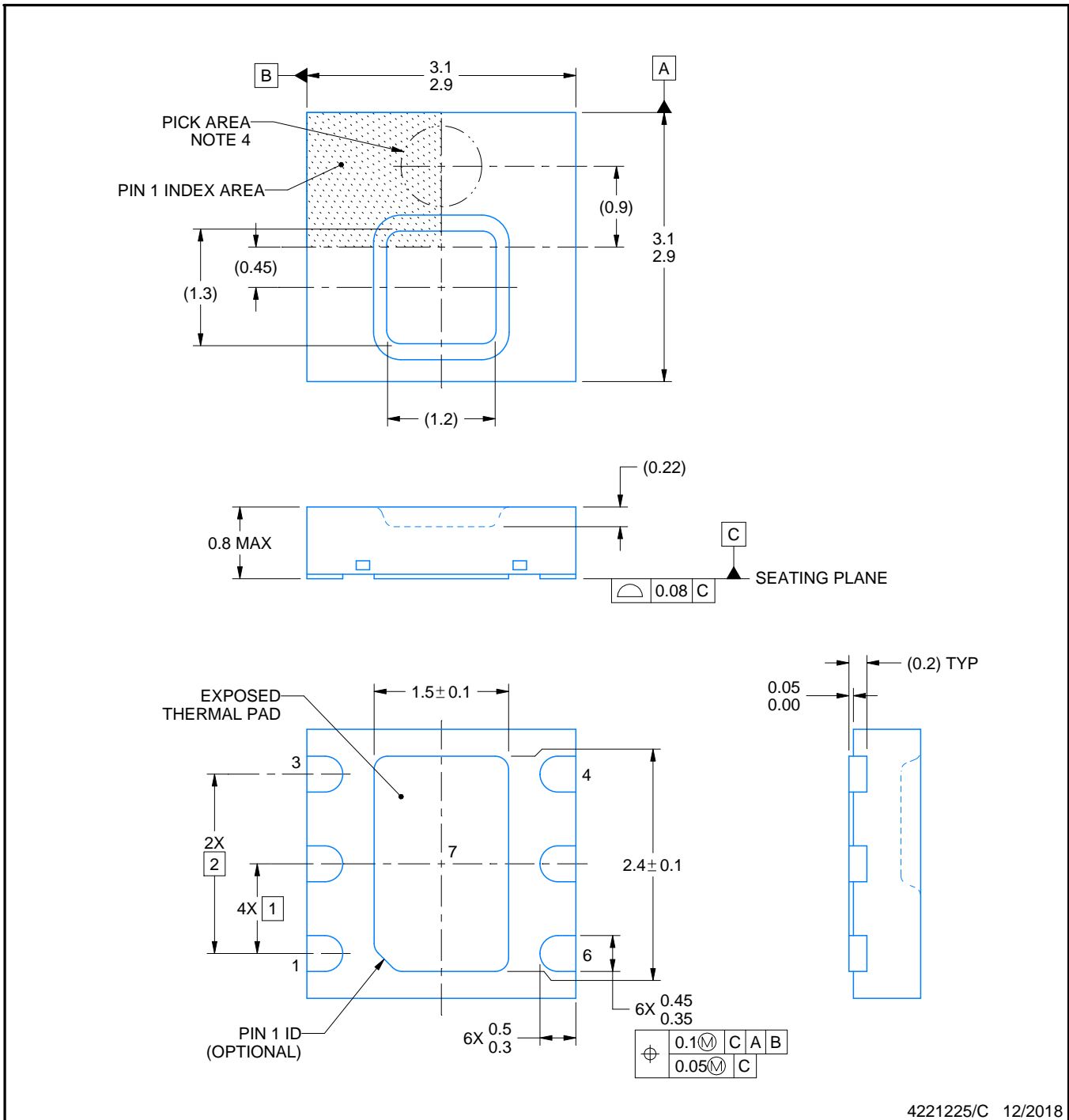

4221225/C 12/2018

NOTES:

1. All linear dimensions are in millimeters. Any dimensions in parenthesis are for reference only. Dimensioning and tolerancing per ASME Y14.5M.
2. This drawing is subject to change without notice.
3. The package thermal pad must be soldered to the printed circuit board for thermal and mechanical performance.
4. Pick and place nozzle \varnothing 0.9 mm or smaller recommended.

EXAMPLE STENCIL DESIGN**DMB0006A****WSON - 0.8 mm max height**

PLASTIC SMALL OUTLINE - NO LEAD

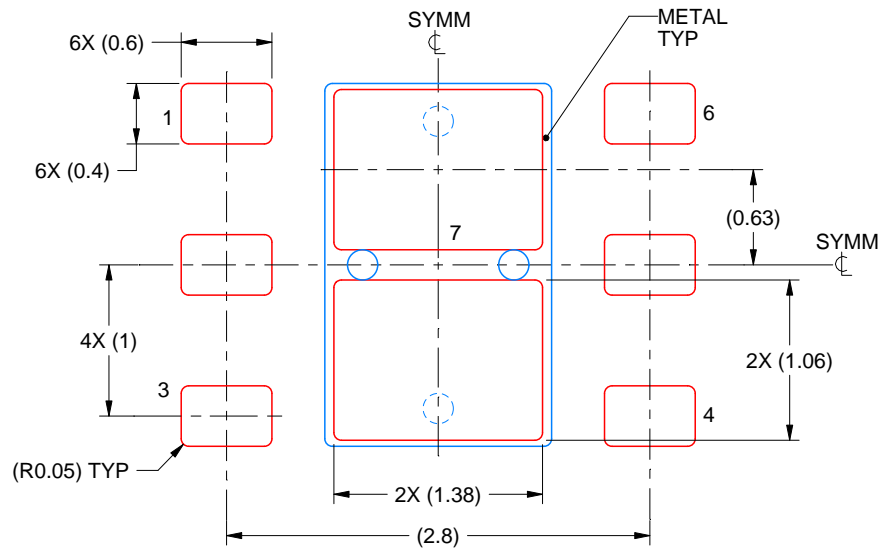

SOLDER PASTE EXAMPLE
 BASED ON 0.125 mm THICK STENCIL

EXPOSED PAD 7:
 81% PRINTED SOLDER COVERAGE BY AREA UNDER PACKAGE
 SCALE:20X

4221225/C 12/2018

NOTES: (continued)

7. Laser cutting apertures with trapezoidal walls and rounded corners may offer better paste release. IPC-7525 may have alternate design recommendations.

IMPORTANT NOTICE AND DISCLAIMER

TI PROVIDES TECHNICAL AND RELIABILITY DATA (INCLUDING DATASHEETS), DESIGN RESOURCES (INCLUDING REFERENCE DESIGNS), APPLICATION OR OTHER DESIGN ADVICE, WEB TOOLS, SAFETY INFORMATION, AND OTHER RESOURCES "AS IS" AND WITH ALL FAULTS, AND DISCLAIMS ALL WARRANTIES, EXPRESS AND IMPLIED, INCLUDING WITHOUT LIMITATION ANY IMPLIED WARRANTIES OF MERCHANTABILITY, FITNESS FOR A PARTICULAR PURPOSE OR NON-INFRINGEMENT OF THIRD PARTY INTELLECTUAL PROPERTY RIGHTS.

These resources are intended for skilled developers designing with TI products. You are solely responsible for (1) selecting the appropriate TI products for your application, (2) designing, validating and testing your application, and (3) ensuring your application meets applicable standards, and any other safety, security, regulatory or other requirements.

These resources are subject to change without notice. TI grants you permission to use these resources only for development of an application that uses the TI products described in the resource. Other reproduction and display of these resources is prohibited. No license is granted to any other TI intellectual property right or to any third party intellectual property right. TI disclaims responsibility for, and you fully indemnify TI and its representatives against any claims, damages, costs, losses, and liabilities arising out of your use of these resources.

TI's products are provided subject to [TI's Terms of Sale](#), [TI's General Quality Guidelines](#), or other applicable terms available either on ti.com or provided in conjunction with such TI products. TI's provision of these resources does not expand or otherwise alter TI's applicable warranties or warranty disclaimers for TI products. Unless TI explicitly designates a product as custom or customer-specified, TI products are standard, catalog, general purpose devices.

TI objects to and rejects any additional or different terms you may propose.

Copyright © 2025, Texas Instruments Incorporated

Last updated 10/2025

OUR CERTIFICATE

DiGi provide top-quality products and perfect service for customer worldwide through standardization, technological innovation and continuous improvement. DiGi through third-party certification, we strictly control the quality of products and services. Welcome your RFQ to

Email: Info@DiGi-Electronics.com



Tel: +00 852-30501935

RFQ Email: Info@DiGi-Electronics.com

DiGi is a global authorized distributor of electronic components.