

LM2903DGKRG4 Datasheet

www.digi-electronics.com

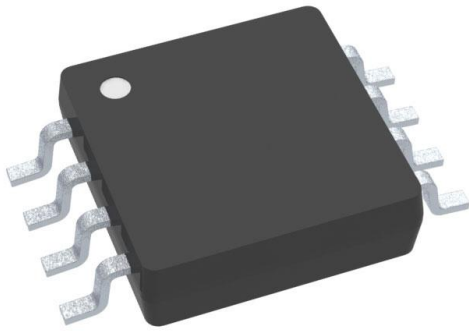

<https://www.DiGi-Electronics.com>

DiGi Electronics Part Number	LM2903DGKRG4-DG
Manufacturer	Texas Instruments
Manufacturer Product Number	LM2903DGKRG4
Description	IC COMPARATOR 2 DIFF 8VSSOP
Detailed Description	Comparator General Purpose Open-Collector, Rail-to-Rail 8-VSSOP



Tel: +00 852-30501935

RFQ Email: Info@DiGi-Electronics.com

DiGi is a global authorized distributor of electronic components.

Purchase and inquiry

Manufacturer Product Number:

LM2903DGKRG4

Series:

-

Type:

General Purpose

Output Type:

Open-Collector, Rail-to-Rail

Voltage - Input Offset (Max):

7mV @ 30V

Current - Output (Typ):

20mA

CMRR, PSRR (Typ):

-

Hysteresis:

-

Package / Case:

8-TSSOP, 8-MSOP (0.118", 3.00mm Width)

Supplier Device Package:

8-VSSOP

Manufacturer:

Texas Instruments

Product Status:

Obsolete

Number of Elements:

2

Voltage - Supply, Single/Dual (\pm):

2V ~ 36V, \pm 1V ~ 18V

Current - Input Bias (Max):

0.25 μ A @ 5V

Current - Quiescent (Max):

2.5mA

Propagation Delay (Max):

-

Operating Temperature:

-40°C ~ 125°C

Mounting Type:

Surface Mount

Base Product Number:

LM2903

Environmental & Export classification

RoHS Status:

ROHS3 Compliant

REACH Status:

REACH Unaffected

HTSUS:

8542.39.0001

Moisture Sensitivity Level (MSL):

1 (Unlimited)

ECCN:

EAR99



LM393B, LM2903B, LM193, LM293, LM393 and LM2903 Dual Comparators

1 Features

- NEW [LM393B](#) and [LM2903B](#)
- Improved specifications of B-version
 - Maximum rating: up to 38V
 - ESD rating (HBM): 2kV
 - Low input offset: 0.37mV
 - Low input bias current: 3.5nA
 - Low supply-current: 200µA per comparator
 - Faster response time of 1µsec
 - Extended temperature range for LM393B
 - Available in tiny 2 x 2mm WSON package
- B-version is drop-in replacement for LM293, LM393 and LM2903, A and V versions
- Common-mode input voltage range includes ground
- Differential input voltage range equal to maximum-rated supply voltage: ±38 V
- Low output saturation voltage
- Output compatible with TTL, MOS, and CMOS

2 Applications

- [Vacuum robot](#)
- [Single phase UPS](#)
- [Server PSU](#)
- [Cordless power tool](#)
- [Wireless infrastructure](#)
- [Appliances](#)
- [Building automation](#)
- [Factory automation & control](#)
- [Motor drives](#)
- [Infotainment & cluster](#)

3 Description

The [LM393B](#) and [LM2903B](#) devices are the next generation versions of the industry-standard LM393 and LM2903 comparator family. These next generation B-version comparators feature lower offset voltage, higher supply voltage capability, lower supply current, lower input bias current, lower propagation delay, and improved 2 kV ESD performance and input ruggedness through dedicated ESD clamps. The LM393B and LM2903B can drop-in replace the LM293, LM393 and LM2903, for both "A" and "V" grades.

All devices consist of two independent voltage comparators that are designed to operate from a single power supply over a wide range of voltages. Quiescent current is independent of the supply voltage.

Device Information

PART NUMBER	PACKAGE ⁽¹⁾	BODY SIZE (NOM)
LM393B, LM2903B, LM193, LM293, LM293A, LM393, LM393A, LM2903, LM2903V, LM2903AV	SOIC (8)	4.90mm x 3.91mm
LM393B, LM2903B, LM293, LM293A, LM393, LM393A, LM2903	VSSOP (8)	3.00mm x 3.00mm
LM293, LM393, LM393A, LM2903	PDIP (8)	9.81mm x 6.35mm
LM393, LM393A, LM2903	SO (8)	6.20mm x 5.30mm
LM393B, LM2903B, LM393, LM393A, LM2903, LM2903V, LM2903AV	TSSOP (8)	3.00mm x 4.40mm
LM393B, LM2903B	SOT-23 (8)	2.90mm x 1.60mm
LM393B, LM2903B	WSON (8)	2.00mm x 2.00mm

(1) For all available packages, see the orderable addendum at the end of the data sheet.

Family Comparison Table

Specification	LM393B	LM2903B	LM393 LM393A	LM2903	LM2903V LM2903AV	LM193	LM293 LM293A	Units
Supply Voltage	2 to 36	2 to 36	2 to 30	2 to 30	2 to 32	2 to 30	2 to 30	V
Total Supply Current (5V to 36V max)	0.6 to 0.8	0.6 to 0.8	1 to 2.5	1 to 2.5	1 to 2.5	1 to 2.5	1 to 2.5	mA
Temperature Range	-40 to 85	-40 to 125	0 to 70	-40 to 125	-40 to 125	-55 to 125	-25 to 85	°C
ESD (HBM)	2000	2000	1000	1000	1000	1000	1000	V
Offset Voltage (Max over temp)	± 4	± 4	± 9 ± 4	± 15	± 15 ± 4	± 9	± 9 ± 4	mV
Input Bias Current (typ / max)	3.5 / 25	3.5 / 25	25 / 250	25 / 250	25 / 250	25 / 100	25 / 250	nA
Response Time (typ)	1	1	1.3	1.3	1.3	1.3	1.3	µsec



Table of Contents

1 Features	1	5.12 Typical Characteristics, LMx93x and LM2903x.....	11
2 Applications	1	6 Detailed Description	17
3 Description	1	6.1 Overview.....	17
4 Pin Configuration and Functions	3	6.2 Functional Block Diagram.....	17
5 Specifications	4	6.3 Feature Description.....	17
5.1 Absolute Maximum Ratings.....	4	6.4 Device Functional Modes.....	17
5.2 Recommended Operating Conditions.....	4	7 Application and Implementation	18
5.3 Thermal Information: LMx93x and LM2903x.....	5	7.1 Application Information.....	18
5.4 ESD Ratings.....	5	7.2 Typical Application.....	18
5.5 Electrical Characteristics LM393B.....	6	8 Device and Documentation Support	21
5.6 Electrical Characteristics LM2903B.....	7	8.1 Receiving Notification of Documentation Updates....	21
5.7 Switching Characteristics LM393B and LM2903B.....	7	8.2 Support Resources.....	21
5.8 Electrical Characteristics for LM193, LM293, and LM393 (without A suffix).....	8	8.3 Trademarks.....	21
5.9 Electrical Characteristics for LM293A and LM393A....	9	8.4 Electrostatic Discharge Caution.....	21
5.10 Electrical Characteristics for LM2903, LM2903V, and LM2903AV.....	10	8.5 Glossary.....	21
5.11 Switching Characteristics: LM193, LM239, LM393, LM2903, all 'A' and 'V' versions.....	10	9 Revision History	21
		10 Mechanical, Packaging, and Orderable Information	22

4 Pin Configuration and Functions

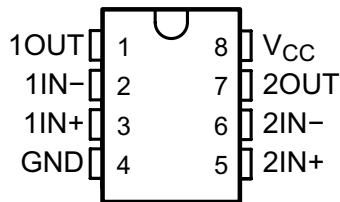
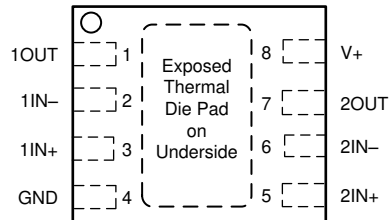

Figure 4-1. D, DGK, JG, P, PS, DDF or PW Package 8-Pin SOIC, VSSOP, PDIP, SO, or TSSOP Top View



Connect thermal pad directly to GND pin.

Figure 4-2. DSG Package 8-Pin WSON With Exposed Pad Top View

Table 4-1. Pin Functions

NAME	PIN		I/O	DESCRIPTION
	SOIC, VSSOP, PDIP, SO, DDF and TSSOP	DSG		
1OUT	1	1	Output	Output pin of comparator 1
1IN-	2	2	Input	Negative input pin of comparator 1
1IN+	3	3	Input	Positive input pin of comparator 1
GND	4	4	—	Ground
2IN+	5	5	Input	Positive input pin of comparator 2
2IN-	6	6	Input	Negative input pin of comparator 2
2OUT	7	7	Output	Output pin of comparator 2
V _{CC}	8	8	—	Positive Supply
Thermal Pad	—	PAD	—	Connect directly to GND pin

5 Specifications

5.1 Absolute Maximum Ratings

over operating free-air temperature range (unless otherwise noted) ⁽¹⁾

		MIN	MAX	UNIT
V _{CC}	Supply voltage ⁽²⁾	Non-B Versions	36	V
		B Versions Only	38	
V _{ID}	Differential input voltage ⁽³⁾	Non-B Versions	36	V
		B Versions Only	38	
V _I	Input voltage (either input)	Non-B Versions	36	V
		B Versions Only	38	
I _{IK}	Input current ⁽⁵⁾		-50	mA
V _O	Output voltage	Non-B Versions	36	V
		B Versions Only	38	
I _O	Output current	Non-B Versions	20	mA
		B Versions Only	25	
I _{SC}	Duration of output short circuit to ground ⁽⁴⁾	Unlimited		
T _J	Operating virtual-junction temperature		150	°C
T _{stg}	Storage temperature	-65	150	°C

- (1) Stresses beyond those listed under *Absolute Maximum Ratings* can cause permanent damage to the device. These are stress ratings only, and functional operation of the device at these or any other conditions beyond those indicated under *Recommended Operating Conditions* is not implied. Exposure to absolute-maximum-rated conditions for extended periods can affect device reliability. Production Processing Does Not Necessarily Include Testing of All Parameters.
- (2) All voltage values, except differential voltages, are with respect to network ground.
- (3) Differential voltages are at IN+ with respect to IN-.
- (4) Short circuits from outputs to V_{CC} can cause excessive heating and eventual destruction.
- (5) Input current flows thorough parasitic diode to ground and turns on parasitic transistors that increases I_{CC} and can cause the output to be incorrect. Normal operation resumes when input current is removed.

5.2 Recommended Operating Conditions

Over operating free-air temperature range (unless otherwise noted)

		MIN	MAX	UNIT
Supply voltage, V _S = (V+) – (V-)	non-V devices	2	30	V
	V devices	2	32	
	"B" version devices	2	36	
Input voltage range, V _{IVR}	non-B devices	0	(V+) – 2.0	V
	"B" version devices	-0.1		
Ambient temperature, T _A	LM193	-55	125	°C
	LM2903, LM2903V, LM2903AV, LM2903B	-40	125	
	LM393B	-40	85	
	LM293, LM293A	-25	85	
	LM393, LM393A	0	70	

5.3 Thermal Information: LMx93x and LM2903x

THERMAL METRIC ⁽¹⁾		LMx93x, LM2903x					UNIT
		D (SOIC)	PW (TSSOP)	DGK (VSSOP)	DDF (SOT-23)	DSG (WSON)	
		8 pin	8 pin	8 pin	8 pin	8 pins	
R _{θJA}	Junction-to-ambient thermal resistance	148.5	200.6	193.7	197.9	96.9	°C/W
R _{θJC(top)}	Junction-to-case (top) thermal resistance	90.2	89.6	82.9	119.2	119.0	°C/W
R _{θJB}	Junction-to-board thermal resistance	91.8	131.3	115.5	115.4	63.1	°C/W
ψ _{JT}	Junction-to-top characterization parameter	38.5	22.1	20.8	19.4	12.4	°C/W
ψ _{JB}	Junction-to-board characterization parameter	91.1	129.6	113.9	113.7	63.0	°C/W
R _{θJC(bot)}	Junction-to-case (bottom) thermal resistance	-	-	-	-	37.8	°C/W

(1) For more information about traditional and new thermal metrics, see the [Semiconductor and IC Package Thermal Metrics](#) report.

5.4 ESD Ratings

			VALUE	UNIT
V _(ESD)	Electrostatic discharge	Human body model (HBM), per ANSI/ESDA/JEDEC JS-001 ⁽¹⁾	±2000	V
		Charged-device model (CDM), per JEDEC specification JESD22-C101 ⁽²⁾	±1000	

(1) JEDEC document JEP155 states that 500V HBM allows safe manufacturing with a standard ESD control process.

(2) JEDEC document JEP157 states that 250V CDM allows safe manufacturing with a standard ESD control process.

LM393B, LM2903B, LM193, LM293, LM293A, LM393, LM393A, LM2903, LM2903V

SLCS005AG – OCTOBER 1979 – REVISED JANUARY 2025

5.5 Electrical Characteristics LM393B
 $V_S = 5V$, $V_{CM} = (V-)$; $T_A = 25^\circ C$ (unless otherwise noted).

PARAMETER		TEST CONDITIONS	MIN	TYP	MAX	UNIT
V_{IO}	Input offset voltage	$V_S = 5$ to 36V	-2.5	± 0.37	2.5	mV
		$V_S = 5$ to 36V, $T_A = -40^\circ C$ to $+85^\circ C$	-4		4	
	Input offset voltage, DGK package only	$V_S = 5$ to 36V	-3.5	± 0.37	3.5	
		$V_S = 5$ to 36V, $T_A = -40^\circ C$ to $+85^\circ C$	-5		5	
I_B	Input bias current			-3.5	-25	nA
		$T_A = -40^\circ C$ to $+85^\circ C$			-50	nA
I_{OS}	Input offset current		-10	± 0.5	10	nA
		$T_A = -40^\circ C$ to $+85^\circ C$			-25	25
V_{CM}	Common mode range ⁽¹⁾	$V_S = 3$ to 36V	(V-)		(V+) - 1.5	V
		$V_S = 3$ to 36V, $T_A = -40^\circ C$ to $+85^\circ C$	(V-)		(V+) - 2.0	V
A_{VD}	Large signal differential voltage amplification	$V_S = 15V$, $V_O = 1.4V$ to $11.4V$; $R_L \geq 15k$ to (V+)	50	200		V/mV
V_{OL}	Low level output Voltage {swing from (V-)}	$I_{SINK} \leq 4mA$, $V_{ID} = -1V$		110	400	mV
		$I_{SINK} \leq 4mA$, $V_{ID} = -1V$ $T_A = -40^\circ C$ to $+85^\circ C$			550	mV
I_{OH-LKG}	High-level output leakage current	(V+) = $V_O = 5V$; $V_{ID} = 1V$		0.1	20	nA
		(V+) = $V_O = 36V$; $V_{ID} = 1V$		0.3	50	nA
I_{OL}	Low level output current	$V_{OL} = 1.5V$; $V_{ID} = -1V$; $V_S = 5V$	6	21		mA
I_Q	Quiescent current (all comparators)	$V_S = 5V$, no load		400	600	μA
		$V_S = 36V$, no load, $T_A = -40^\circ C$ to $+85^\circ C$		550	800	μA

- (1) The voltage at either input can not be allowed to go negative by more than 0.3V otherwise output can be incorrect and excessive input current can flow. The upper end of the common-mode voltage range is limited by $V_{CC} - 2V$. However only one input needs to be in the valid common mode range, the other input can go up the maximum V_{CC} level and the comparator provides a proper output state. Either or both inputs can go to maximum V_{CC} level without damage.

5.6 Electrical Characteristics LM2903B

 $V_S = 5V, V_{CM} = (V-); T_A = 25^\circ C$ (unless otherwise noted).

PARAMETER		TEST CONDITIONS	MIN	TYP	MAX	UNIT
V_{IO}	Input offset voltage	$V_S = 5$ to 36V	-2.5	± 0.37	2.5	mV
		$V_S = 5$ to 36V, $T_A = -40^\circ C$ to $+125^\circ C$	-4		4	
	Input offset voltage, DGK package only	$V_S = 5$ to 36V	-3.5	± 0.37	3.5	
		$V_S = 5$ to 36V, $T_A = -40^\circ C$ to $+125^\circ C$	-5		5	
I_B	Input bias current			-3.5	-25	nA
		$T_A = -40^\circ C$ to $+125^\circ C$			-50	nA
I_{OS}	Input offset current		-10	± 0.5	10	nA
		$T_A = -40^\circ C$ to $+125^\circ C$			-25	25
V_{CM}	Common mode range ⁽¹⁾	$V_S = 3$ to 36V	(V-)		(V+) - 1.5	V
		$V_S = 3$ to 36V, $T_A = -40^\circ C$ to $+125^\circ C$	(V-)		(V+) - 2.0	V
A_{VD}	Large signal differential voltage amplification	$V_S = 15V, V_O = 1.4V$ to 11.4V; $R_L \geq 15k$ to (V+)	50	200		V/mV
V_{OL}	Low level output Voltage {swing from (V-)}	$I_{SINK} \leq 4mA, V_{ID} = -1V$		110	400	mV
		$I_{SINK} \leq 4mA, V_{ID} = -1V$ $T_A = -40^\circ C$ to $+125^\circ C$			550	mV
I_{OH-LKG}	High-level output leakage current	(V+) = $V_O = 5V; V_{ID} = 1V$		0.1	20	nA
		(V+) = $V_O = 36V; V_{ID} = 1V$		0.3	50	nA
I_{OL}	Low level output current	$V_{OL} = 1.5V; V_{ID} = -1V; V_S = 5V$	6	21		mA
I_Q	Quiescent current (all comparators)	$V_S = 5V$, no load		400	600	μA
		$V_S = 36V$, no load, $T_A = -40^\circ C$ to $+125^\circ C$		550	800	μA

- (1) The voltage at either input can not be allowed to go negative by more than 0.3V otherwise output can be incorrect and excessive input current can flow. The upper end of the common-mode voltage range is limited by $V_{CC} - 2V$. However only one input needs to be in the valid common mode range, the other input can go up the maximum V_{CC} level and the comparator provides a proper output state. Either or both inputs can go to maximum V_{CC} level without damage.

5.7 Switching Characteristics LM393B and LM2903B

 $V_S = 5V, V_{O_PULLUP} = 5V, V_{CM} = V_S/2, C_L = 15pF, R_L = 5.1k\ \Omega, T_A = 25^\circ C$ (unless otherwise noted).

PARAMETER		TEST CONDITIONS	MIN	TYP	MAX	UNIT
$t_{response}$	Propagation delay time, high-to-low; TTL input signal ⁽¹⁾	TTL input with $V_{ref} = 1.4V$		300		ns
$t_{response}$	Propagation delay time, high-to-low; Small scale input signal ⁽¹⁾	Input overdrive = 5mV, Input step = 100mV		1000		ns

- (1) High-to-low and low-to-high refers to the transition at the input.

LM393B, LM2903B, LM193, LM293, LM293A, LM393, LM393A, LM2903, LM2903V

SLCS005AG – OCTOBER 1979 – REVISED JANUARY 2025

5.8 Electrical Characteristics for LM193, LM293, and LM393 (without A suffix)
at specified free-air temperature, $V_{CC} = 5V$ (unless otherwise noted)

PARAMETER	TEST CONDITIONS	T_A ⁽¹⁾	LM193			LM293 LM393			UNIT	
			MIN	TYP	MAX	MIN	TYP	MAX		
V_{IO} Input offset voltage	$V_{CC} = 5V$ to $30V$, $V_{IC} = V_{ICR}$ min, $V_O = 1.4V$	25°C		2	5		2	5	mV	
		Full range			9			9		
I_{IO} Input offset current	$V_O = 1.4V$	25°C		3	25		5	50	nA	
		Full range			100			250		
I_{IB} Input bias current	$V_O = 1.4V$	25°C		-25	-100		-25	-250	nA	
		Full range			-300			-400		
V_{ICR} Common-mode input-voltage range ⁽²⁾		25°C		0 to $V_{CC} - 1.5$			0 to $V_{CC} - 1.5$		V	
		Full range		0 to $V_{CC} - 2$			0 to $V_{CC} - 2$			
A_{VD} Large-signal differential-voltage amplification	$V_{CC} = 15V$, $V_O = 1.4V$ to $11.4V$, $R_L \geq 15k\Omega$ to V_{CC}	25°C		50	200		50	200	V/mV	
I_{OH} High-level output current	$V_{OH} = 5V$	$V_{ID} = 1V$	25°C		0.1		0.1	50	nA	
	$V_{OH} = 30V$	$V_{ID} = 1V$	Full range			1		1	μA	
V_{OL} Low-level output voltage	$I_{OL} = 4mA$, $V_{ID} = -1V$	25°C		150	400		130	400	mV	
		Full range			700			700		
I_{OL} Low-level output current	$V_{OL} = 1.5V$, $V_{ID} = -1V$	25°C		6			6		mA	
I_{CC} Supply current	$R_L = \infty$	$V_{CC} = 5V$	25°C		0.8	1		0.45	1	mA
		$V_{CC} = 30V$	Full range			2.5		0.55	2.5	

- (1) Full range (minimum or maximum) for LM193 is $-55^\circ C$ to $125^\circ C$, for LM293 is $-25^\circ C$ to $85^\circ C$, and for LM393 is $0^\circ C$ to $70^\circ C$. All characteristics are measured with zero common-mode input voltage, unless otherwise specified.
- (2) The voltage at either input can not be allowed to go negative by more than $0.3V$ otherwise output can be incorrect and excessive input current can flow. The upper end of the common-mode voltage range is limited by $V_{CC} - 2V$. However only one input needs to be in the valid common mode range, and the other input can go up the maximum V_{CC} level and the comparator provides a proper output state. Either or both inputs can go to maximum V_{CC} level without damage.

5.9 Electrical Characteristics for LM293A and LM393A

at specified free-air temperature, $V_{CC} = 5V$ (unless otherwise noted)

PARAMETER	TEST CONDITIONS	T_A ⁽¹⁾	LM293A LM393A			UNIT
			MIN	TYP	MAX	
V_{IO} Input offset voltage	$V_{CC} = 5V$ to $30V$, $V_O = 1.4V$ $V_{IC} = V_{ICR(min)}$	$25^\circ C$		1	2	mV
		Full range			4	
I_{IO} Input offset current	$V_O = 1.4V$	$25^\circ C$		5	50	nA
		Full range			150	
I_{IB} Input bias current	$V_O = 1.4V$	$25^\circ C$		-25	-250	nA
		Full range			-400	
V_{ICR} Common-mode input-voltage range ⁽²⁾		$25^\circ C$		0 to $V_{CC} - 1.5$		V
		Full range		0 to $V_{CC} - 2$		
A_{VD} Large-signal differential-voltage amplification	$V_{CC} = 15V$, $V_O = 1.4V$ to $11.4V$, $R_L \geq 15k\Omega$ to V_{CC}	$25^\circ C$		50	200	V/mV
I_{OH} High-level output current	$V_{OH} = 5V$, $V_{ID} = 1V$	$25^\circ C$		0.1	50	nA
	$V_{OH} = 30V$, $V_{ID} = 1V$	Full range			1	μA
V_{OL} Low-level output voltage	$I_{OL} = 4mA$, $V_{ID} = -1V$	$25^\circ C$		110	400	mV
		Full range			700	
I_{OL} Low-level output current	$V_{OL} = 1.5V$, $V_{ID} = -1V$	$25^\circ C$		6		mA
I_{CC} Supply current	$R_L = \infty$	$V_{CC} = 5V$	$25^\circ C$	0.60	1	mA
		$V_{CC} = 30V$	Full range	0.72	2.5	

- (1) Full range (minimum or maximum) for LM293A is $-25^\circ C$ to $85^\circ C$, and for LM393A is $0^\circ C$ to $70^\circ C$. All characteristics are measured with zero common-mode input voltage, unless otherwise specified.
- (2) The voltage at either input can not be allowed to go negative by more than $0.3V$ otherwise output can be incorrect and excessive input current can flow. The upper end of the common-mode voltage range is limited by $V_{CC} - 2V$. However only one input needs to be in the valid common mode range, and the other input can go up the maximum V_{CC} level and the comparator provides a proper output state. Either or both inputs can go to maximum V_{CC} level without damage.

LM393B, LM2903B, LM193, LM293, LM293A, LM393, LM393A, LM2903, LM2903V
SLCS005AG – OCTOBER 1979 – REVISED JANUARY 2025

5.10 Electrical Characteristics for LM2903, LM2903V, and LM2903AV

at specified free-air temperature, $V_{CC} = 5V$ (unless otherwise noted)

PARAMETER	TEST CONDITIONS	T_A ⁽¹⁾	LM2903, LM2903V			LM2903AV			UNIT		
			MIN	TYP	MAX	MIN	TYP	MAX			
V_{IO} Input offset voltage	$V_{CC} = 5V$ to MAX ⁽²⁾ , $V_O = 1.4V$, $V_{IC} = V_{ICR(min)}$	25°C		2	7		1	2	mV		
		Full range			15			4			
I_{IO} Input offset current	$V_O = 1.4V$	25°C		5	50		5	50	nA		
		Full range			200			200			
I_{IB} Input bias current	$V_O = 1.4V$	25°C		-25	-250		-25	-250	nA		
		Full range			-500			-500			
V_{ICR} Common-mode input-voltage range ⁽³⁾		25°C		0 to $V_{CC} - 1.5$			0 to $V_{CC} - 1.5$		V		
		Full range		0 to $V_{CC} - 2$			0 to $V_{CC} - 2$				
A_{VD} Large-signal differential-voltage amplification	$V_{CC} = 15V$, $V_O = 1.4V$ to 11.4V, $R_L \geq 15k\Omega$ to V_{CC}	25°C		25	100		25	100	V/mV		
I_{OH} High-level output current	$V_{OH} = 5V$, $V_{ID} = 1V$	25°C			0.1	50		0.1	50	nA	
	$V_{OH} = V_{CC} MAX$ ⁽²⁾ , $V_{ID} = 1V$	Full range				1			1	μA	
V_{OL} Low-level output voltage	$I_{OL} = 4mA$, $V_{ID} = -1V$	25°C			150	400		150	400	mV	
		Full range				700			700		
I_{OL} Low-level output current	$V_{OL} = 1.5V$, $V_{ID} = -1V$	25°C			6			6	mA		
I_{CC} Supply current	$R_L = \infty$	$V_{CC} = 5V$	25°C			0.8	1		0.8	1	mA
		$V_{CC} = MAX$	Full range				2.5			2.5	

- (1) Full range (minimum or maximum) for LM2903 is $-40^\circ C$ to $125^\circ C$. All characteristics are measured with zero common-mode input voltage, unless otherwise specified.
- (2) $V_{CC} MAX = 30V$ for non-V devices and 32V for V-suffix devices.
- (3) The voltage at either input can not be allowed to go negative by more than 0.3V otherwise output can be incorrect and excessive input current can flow. The upper end of the common-mode voltage range is limited by $V_{CC} - 2V$. However only one input needs to be in the valid common mode range, the other input can go up the maximum V_{CC} level and the comparator provides a proper output state. Either or both inputs can go to maximum V_{CC} level without damage.

5.11 Switching Characteristics: LM193, LM239, LM393, LM2903, all 'A' and 'V' versions

$V_{CC} = 5V$, $T_A = 25^\circ C$

PARAMETER	TEST CONDITIONS	TYP	UNIT	
Response time	R_L connected to 5V through 5.1k Ω , $C_L = 15pF$ ⁽¹⁾ (2)	100mV input step with 5mV overdrive	1.3	μs
		TTL-level input step	0.3	

- (1) C_L includes probe and jig capacitance.
- (2) The response time specified is the interval between the input step function and the instant when the output crosses 1.4V.

5.12 Typical Characteristics, LMx93x and LM2903x

$T_A = 25^\circ\text{C}$, $V_S = 5\text{V}$, $R_{\text{PULLUP}} = 5.1\text{k}$, $C_L = 15\text{pF}$, $V_{\text{CM}} = 0\text{V}$, $V_{\text{UNDERDRIVE}} = 100\text{mV}$, $V_{\text{OVERDRIVE}} = 100\text{mV}$ unless otherwise noted.

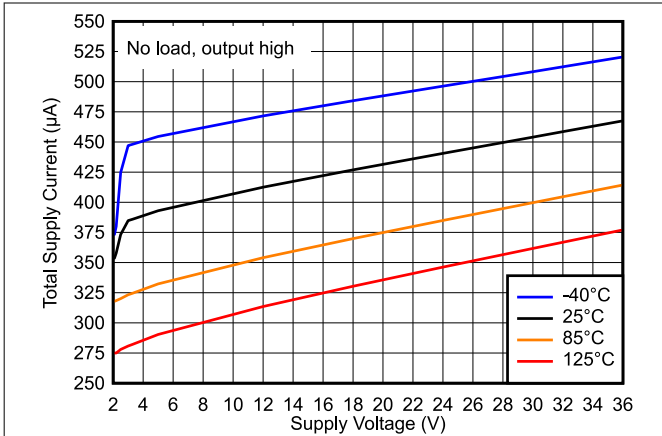

Figure 5-1. Total Supply Current vs. Supply Voltage

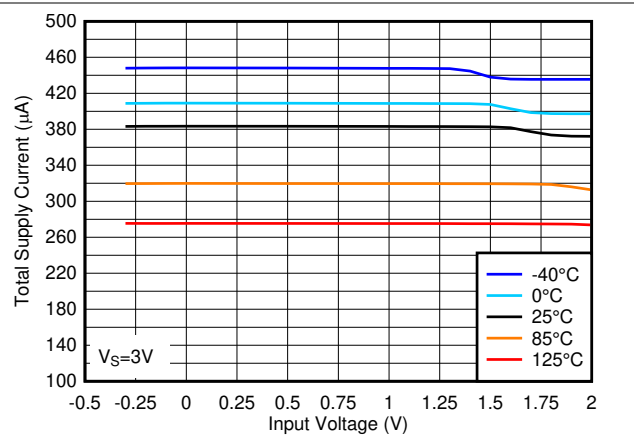

Figure 5-2. Total Supply Current vs. Input Voltage at 3V

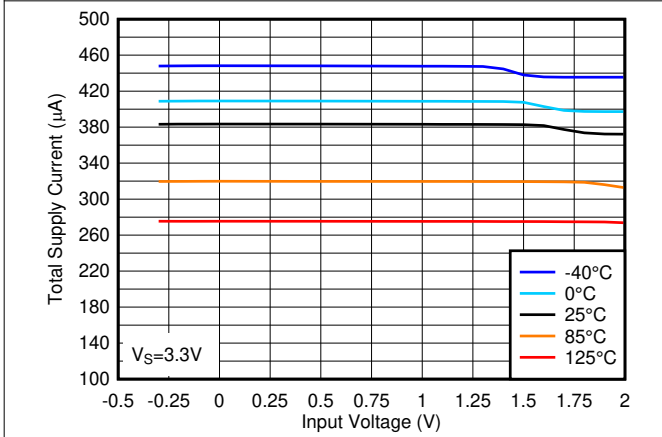

Figure 5-3. Total Supply Current vs. Input Voltage at 3.3V

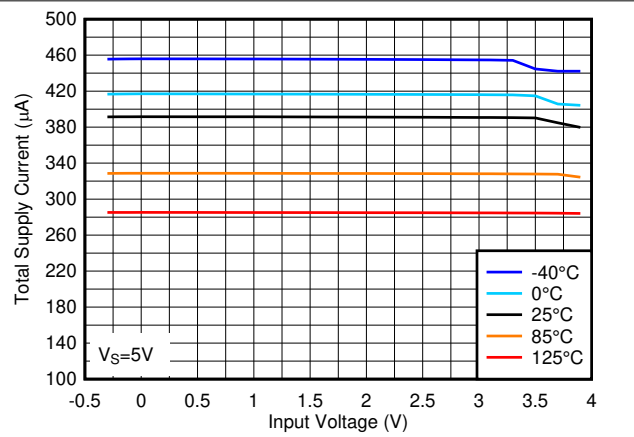

Figure 5-4. Total Supply Current vs. Input Voltage at 5V

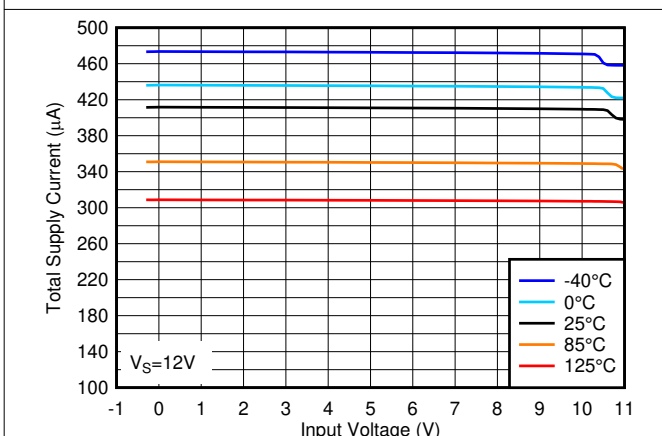

Figure 5-5. Total Supply Current vs. Input Voltage at 12V

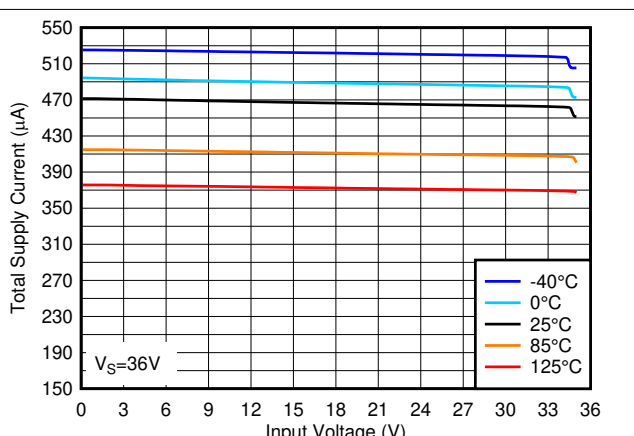

Figure 5-6. Total Supply Current vs. Input Voltage at 36V

LM393B, LM2903B, LM193, LM293, LM293A, LM393, LM393A, LM2903, LM2903V

SLCS005AG – OCTOBER 1979 – REVISED JANUARY 2025

5.12 Typical Characteristics, LMx93x and LM2903x (continued)

$T_A = 25^\circ\text{C}$, $V_S = 5\text{V}$, $R_{\text{PULLUP}} = 5.1\text{k}$, $C_L = 15\text{pF}$, $V_{\text{CM}} = 0\text{V}$, $V_{\text{UNDERDRIVE}} = 100\text{mV}$, $V_{\text{OVERDRIVE}} = 100\text{mV}$ unless otherwise noted.

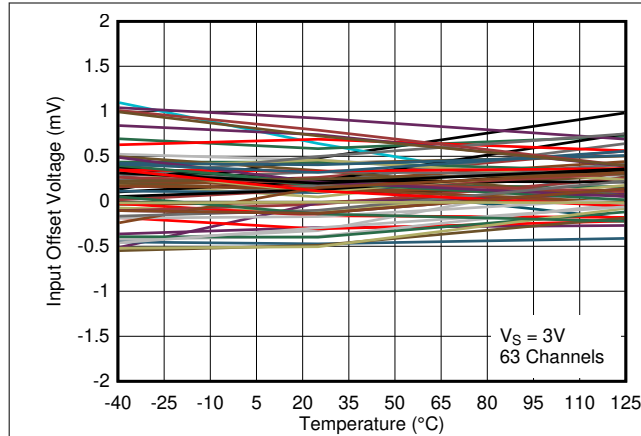

Figure 5-7. Input Offset Voltage vs. Temperature at 3V

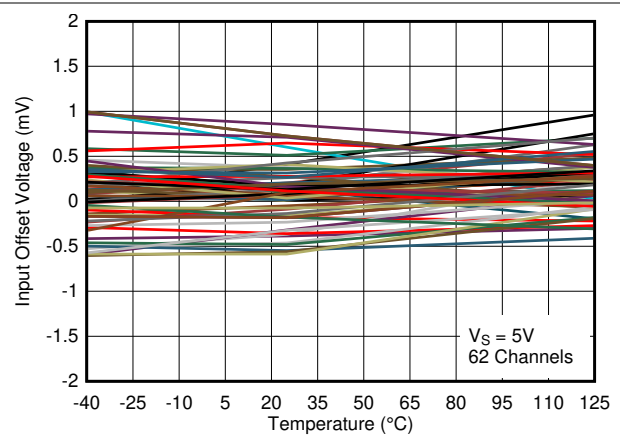

Figure 5-8. Input Offset Voltage vs. Temperature at 5V

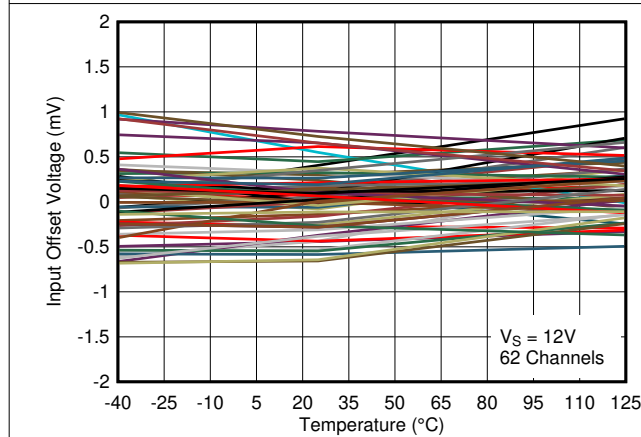

Figure 5-9. Input Offset Voltage vs. Temperature at 12V

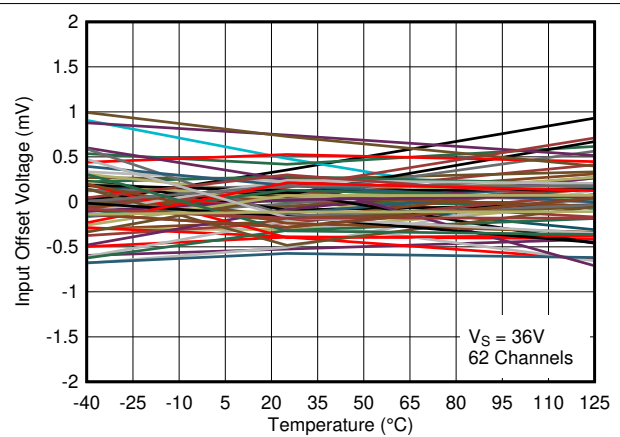
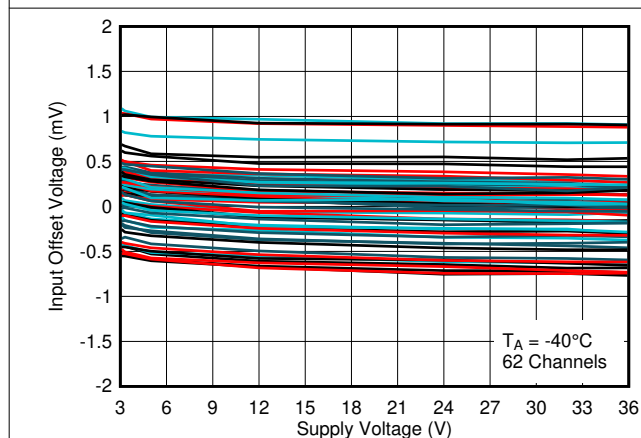
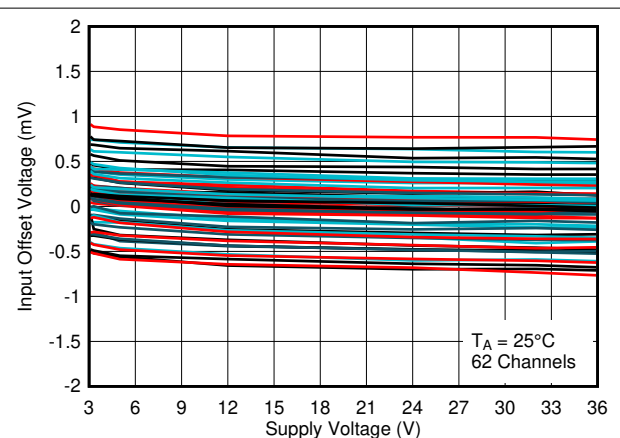

Figure 5-10. Input Offset Voltage vs. Temperature at 36V

Figure 5-11. Input Offset Voltage vs. Supply Voltage at -40°C Figure 5-12. Input Offset Voltage vs. Supply Voltage at 25°C

5.12 Typical Characteristics, LMx93x and LM2903x (continued)

$T_A = 25^\circ\text{C}$, $V_S = 5\text{V}$, $R_{\text{PULLUP}} = 5.1\text{k}$, $C_L = 15\text{pF}$, $V_{\text{CM}} = 0\text{V}$, $V_{\text{UNDERDRIVE}} = 100\text{mV}$, $V_{\text{OVERDRIVE}} = 100\text{mV}$ unless otherwise noted.

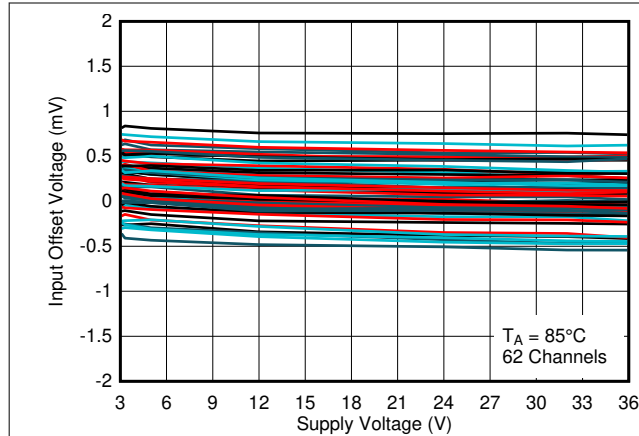

Figure 5-13. Input Offset Voltage vs. Supply Voltage at 85°C

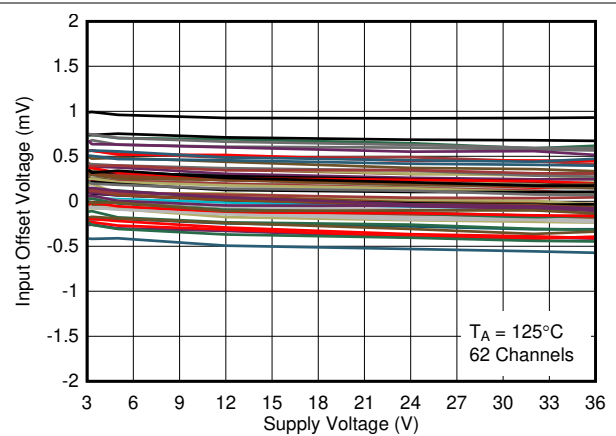

Figure 5-14. Input Offset Voltage vs. Supply Voltage at 125°C

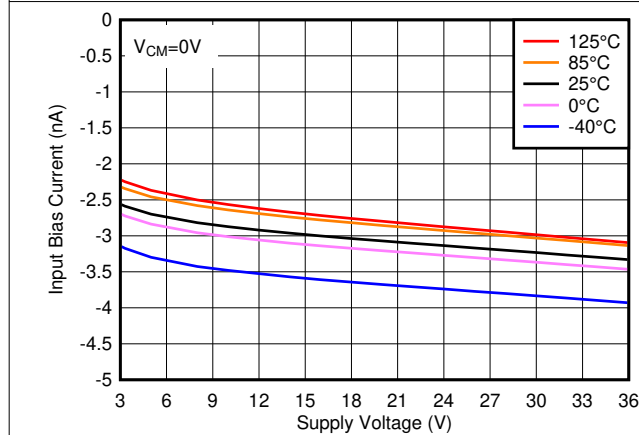

Figure 5-15. Input Bias Current vs. Supply Voltage

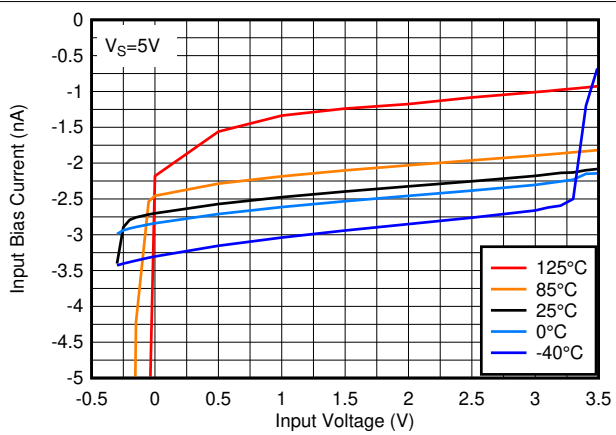

Figure 5-16. Input Bias Current vs. Input Voltage at 5V

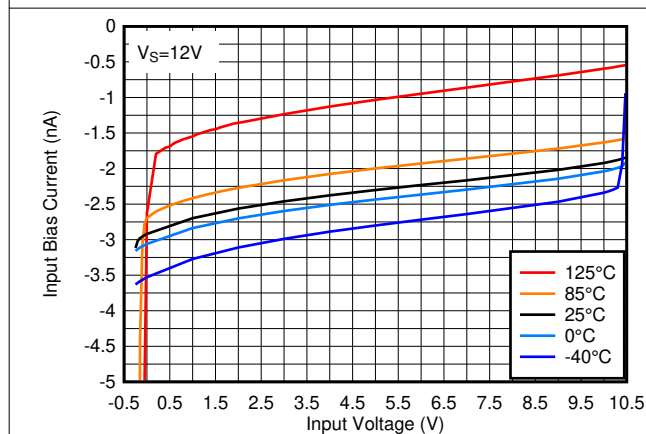

Figure 5-17. Input Bias Current vs. Input Voltage at 12V

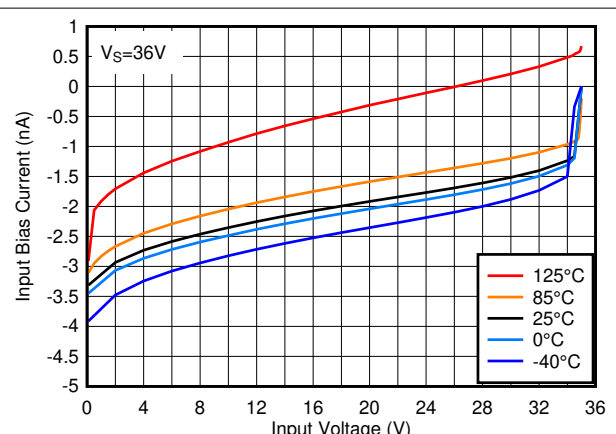

Figure 5-18. Input Bias Current vs. Input Voltage at 36V

5.12 Typical Characteristics, LMx93x and LM2903x (continued)

$T_A = 25^\circ\text{C}$, $V_S = 5\text{V}$, $R_{\text{PULLUP}} = 5.1\text{k}$, $C_L = 15\text{pF}$, $V_{\text{CM}} = 0\text{V}$, $V_{\text{UNDERDRIVE}} = 100\text{mV}$, $V_{\text{OVERDRIVE}} = 100\text{mV}$ unless otherwise noted.

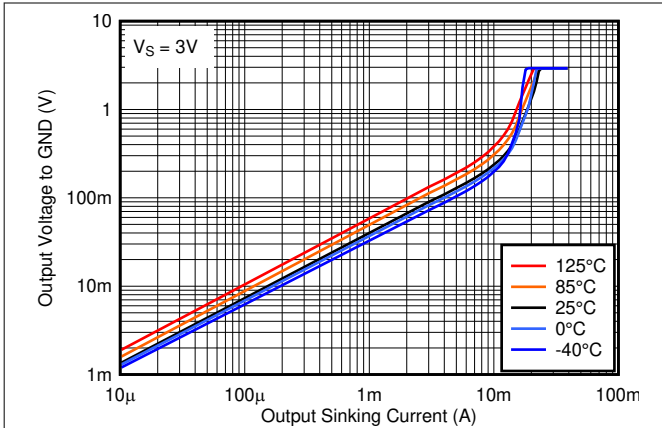

Figure 5-19. Output Low Voltage vs. Output Sinking Current at 3V

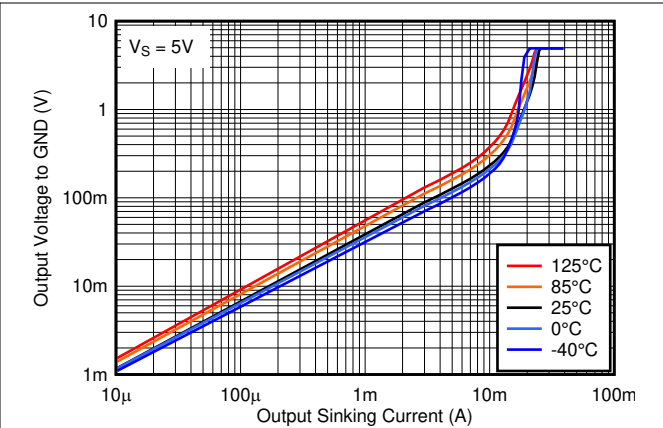

Figure 5-20. Output Low Voltage vs. Output Sinking Current at 5V

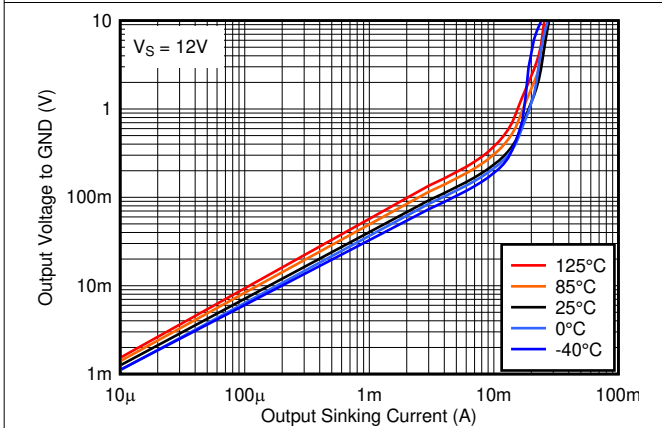

Figure 5-21. Output Low Voltage vs. Output Sinking Current at 12V

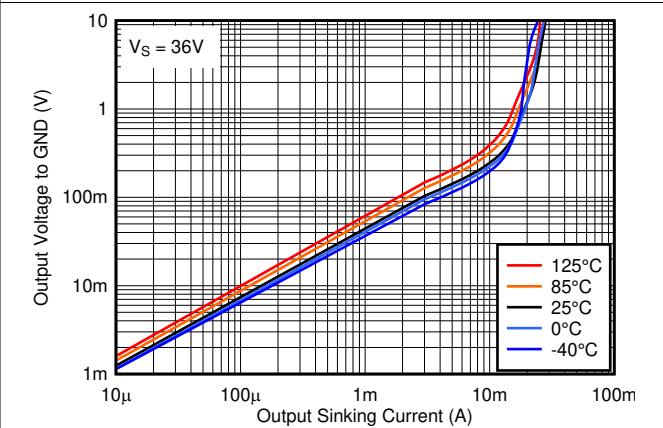

Figure 5-22. Output Low Voltage vs. Output Sinking Current at 36V

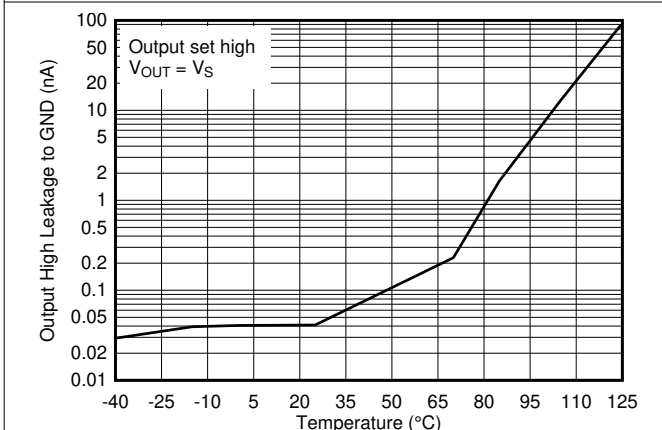

Figure 5-23. Output High Leakage Current vs. Temperature at 5V

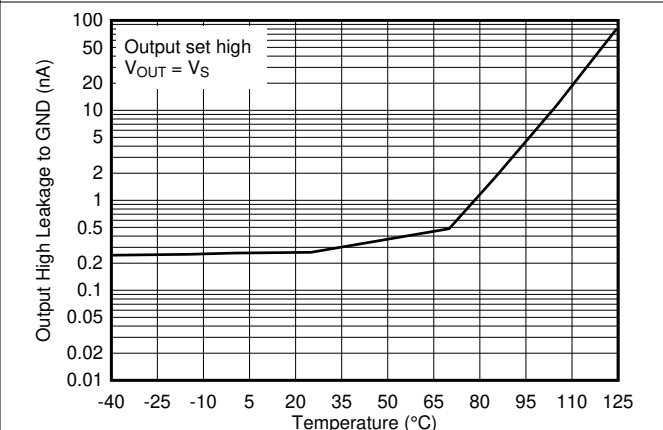

Figure 5-24. Output High Leakage Current vs. Temperature at 36V

5.12 Typical Characteristics, LMx93x and LM2903x (continued)

$T_A = 25^\circ\text{C}$, $V_S = 5\text{V}$, $R_{\text{PULLUP}} = 5.1\text{k}$, $C_L = 15\text{pF}$, $V_{\text{CM}} = 0\text{V}$, $V_{\text{UNDERDRIVE}} = 100\text{mV}$, $V_{\text{OVERDRIVE}} = 100\text{mV}$ unless otherwise noted.

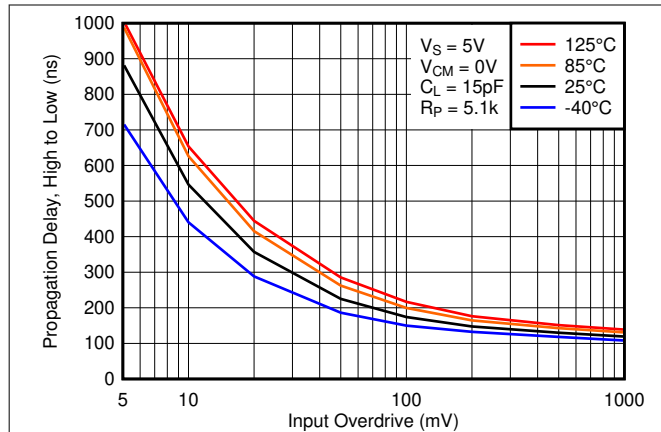

Figure 5-25. High to Low Propagation Delay vs. Input Overdrive Voltage, 5V

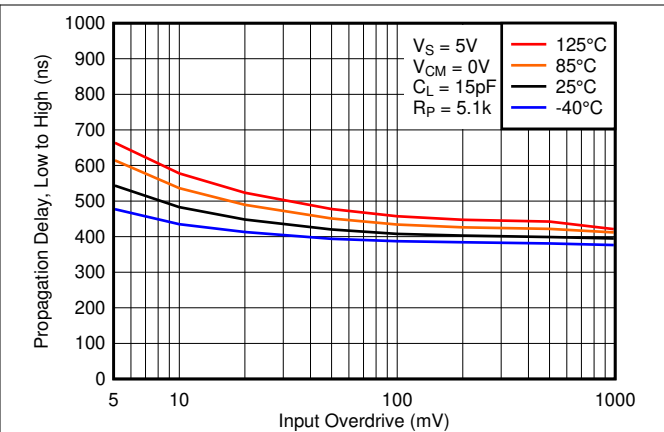

Figure 5-26. Low to High Propagation Delay vs. Input Overdrive Voltage, 5V

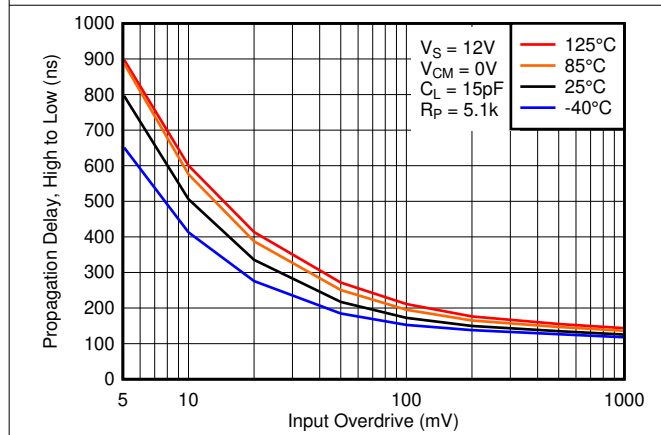

Figure 5-27. High to Low Propagation Delay vs. Input Overdrive Voltage, 12V

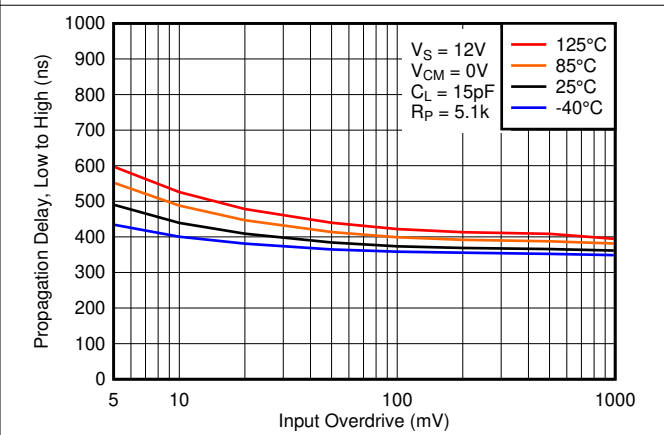

Figure 5-28. Low to High Propagation Delay vs. Input Overdrive Voltage, 12V

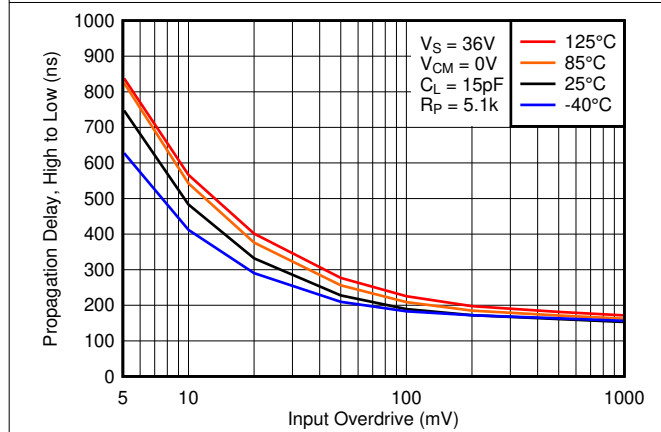

Figure 5-29. High to Low Propagation Delay vs. Input Overdrive Voltage, 36V

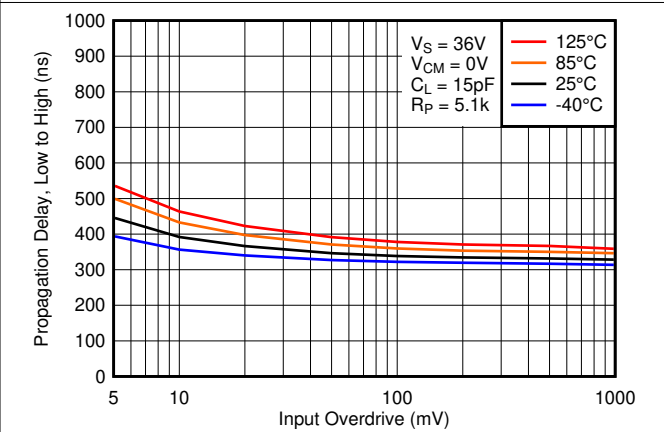

Figure 5-30. Low to High Propagation Delay vs. Input Overdrive Voltage, 36V

LM393B, LM2903B, LM193, LM293, LM293A, LM393, LM393A, LM2903, LM2903V

SLCS005AG – OCTOBER 1979 – REVISED JANUARY 2025

5.12 Typical Characteristics, LMx93x and LM2903x (continued)

$T_A = 25^\circ\text{C}$, $V_S = 5\text{V}$, $R_{\text{PULLUP}} = 5.1\text{k}$, $C_L = 15\text{pF}$, $V_{\text{CM}} = 0\text{V}$, $V_{\text{UNDERDRIVE}} = 100\text{mV}$, $V_{\text{OVERDRIVE}} = 100\text{mV}$ unless otherwise noted.

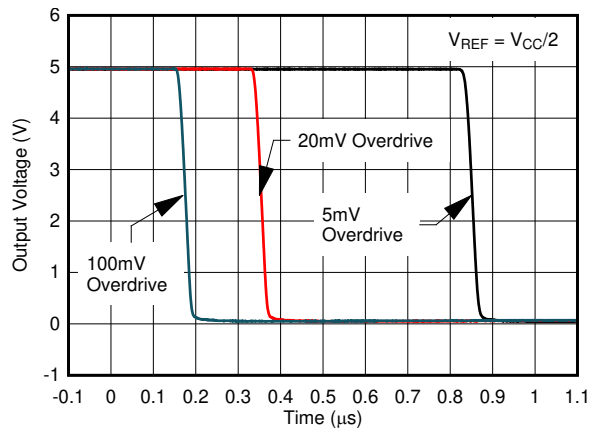

Figure 5-31. Response Time for Various Overdrives, High-to-Low Transition

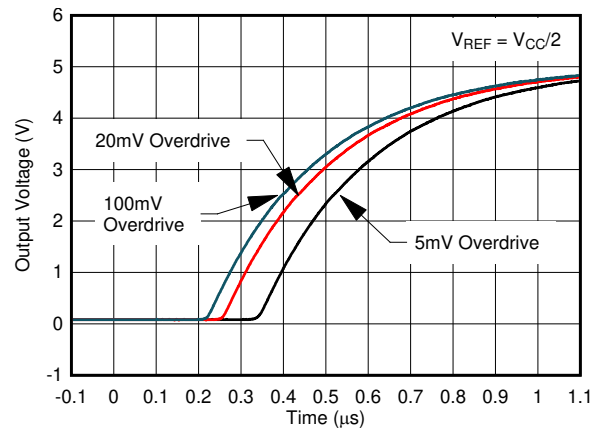

Figure 5-32. Response Time for Various Overdrives, Low-to-High Transition

6 Detailed Description

6.1 Overview

These dual comparators have the ability to operate up to absolute maximum of 36V (38V for the "B" version) on the supply pin. This device has proven ubiquity and versatility across a wide range of applications. This is due to very wide supply voltages range, low I_q and fast response of the devices.

The open-collector outputs allow the user to level shift to the desired logic level independent of V_{CC} , while also enabling AND functionality when multiple outputs are connected together.

6.2 Functional Block Diagram

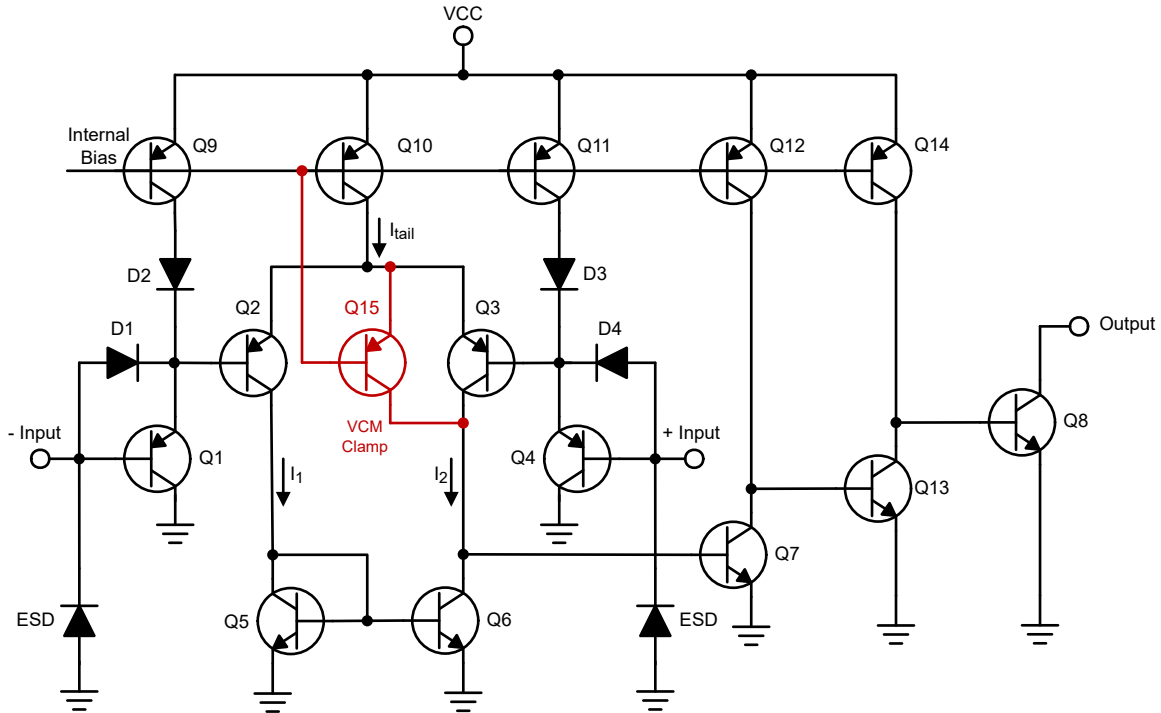

Figure 6-1. Schematic (Each Comparator)

6.3 Feature Description

The comparator consists of a PNP darlington pair input, allowing the device to operate with very high gain and fast response with minimal input bias current. The input Darlington pair creates a limit on the input common mode voltage capability, allowing the comparator to accurately function from ground to $V_{CC} - 2V$ over temperature. A clamp was added around Q3 to mimic the both inputs above input voltage range behavior of the original classic silicon.

The output consists of an open drain NPN (pull-down or low side) transistor. The output NPN sinks current when the negative input voltage is higher than the positive input voltage and the offset voltage. The V_{OL} is resistive and scales with the output current. Please see the "Output Low Voltage vs. Output Sinking Current" graphs for V_{OL} values with respect to the output current.

6.4 Device Functional Modes

6.4.1 Voltage Comparison

The device operates solely as a voltage comparator, comparing the differential voltage between the positive and negative pins and outputting a logic low or high impedance (logic high with pullup) based on the input differential polarity.

7 Application and Implementation

Note

Information in the following applications sections is not part of the TI component specification, and TI does not warrant its accuracy or completeness. TI's customers are responsible for determining suitability of components for their purposes, as well as validating and testing their design implementation to confirm system functionality.

7.1 Application Information

The device is typically used to compare a single signal to a reference or two signals against each other. Many users take advantage of the open drain output to drive the comparison logic output to a logic voltage level to an MCU or logic device. The wide supply range and high voltage capability makes this comparator an excellent choice for level shifting to a higher or lower voltage.

7.2 Typical Application

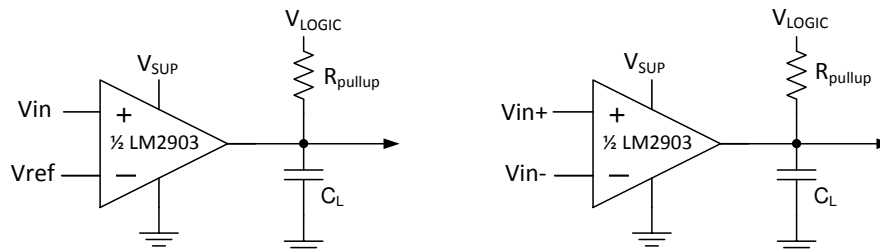

Figure 7-1. Single-Ended and Differential Comparator Configurations

7.2.1 Design Requirements

For this design example, use the parameters listed in [Table 7-1](#) as the input parameters.

Table 7-1. Design Parameters

DESIGN PARAMETER	EXAMPLE VALUE
Input Voltage Range	0V to $V_{sup}-2V$
Supply Voltage	4.5V to V_{CC} maximum
Logic Supply Voltage	0V to V_{CC} maximum
Output Current (R_{PULLUP})	1 μ A to 4mA
Input Overdrive Voltage	100mV
Reference Voltage	2.5V
Load Capacitance (C_L)	15pF

7.2.2 Detailed Design Procedure

When using the device in a general comparator application, determine the following:

- Input Voltage Range
- Minimum Overdrive Voltage
- Output and Drive Current
- Response Time

7.2.2.1 Input Voltage Range

When choosing the input voltage range, the input common mode voltage range (V_{ICR}) must be taken in to account. If temperature operation is below 25°C the V_{ICR} can range from 0V to $V_{CC}-2.0V$. This limits the input

voltage range to as high as $V_{CC} - 2.0V$ and as low as $0V$. Operation outside of this range can yield incorrect comparisons.

The following is a list of input voltage situation and the outcomes:

1. When both $IN-$ and $IN+$ are both within the common-mode range:
 - a. If $IN-$ is higher than $IN+$ and the offset voltage, the output is low and the output transistor is sinking current
 - b. If $IN-$ is lower than $IN+$ and the offset voltage, the output is high impedance and the output transistor is not conducting
2. When $IN-$ is higher than common-mode and $IN+$ is within common-mode, the output is low and the output transistor is sinking current
3. When $IN+$ is higher than common-mode and $IN-$ is within common-mode, the output is high impedance and the output transistor is not conducting
4. When $IN-$ and $IN+$ are both higher than common-mode, see Section 2 of [Application Design Guidelines for LM339, LM393, TL331 Family Comparators Including the New B-versions](#).

7.2.2.2 Minimum Overdrive Voltage

Overdrive Voltage is the differential voltage produced between the positive and negative inputs of the comparator over the offset voltage (V_{IO}). To make an accurate comparison the Overdrive Voltage (V_{OD}) must be higher than the input offset voltage (V_{IO}). Overdrive voltage can also determine the response time of the comparator, with the response time decreasing with increasing overdrive. [Figure 7-2](#) and [Figure 7-3](#) show positive and negative response times with respect to overdrive voltage.

7.2.2.3 Output and Drive Current

Output current is determined by the load/pull-up resistance and logic/pullup voltage. The output current produces a output low voltage (V_{OL}) from the comparator. In which V_{OL} is proportional to the output current. See the *Output Low vs. Sinking Current* graphs in the [Typical Characteristics, LMx93x and LM2903x](#) section to determine V_{OL} based on the output current.

The output current can also effect the transient response. See [Section 7.2.2.4](#) for more information.

7.2.2.4 Response Time

Response time is a function of input over drive. See [Application Curves](#) for typical response times. The rise and falls times can be determined by the load capacitance (C_L), load/pullup resistance (R_{PULLUP}) and equivalent collector-emitter resistance (R_{CE}).

- The rise time (τ_R) is approximately $\tau_R = R_{PULLUP} \times C_L$
- The fall time (τ_F) is approximately $\tau_F = R_{CE} \times C_L$
 - R_{CE} can be determine by taking the slope of [Figure 5-20](#) in the linear region at the desired temperature, or by dividing the V_{OL} by I_{out}

LM393B, LM2903B, LM193, LM293, LM293A, LM393, LM393A, LM2903, LM2903V
SLCS005AG – OCTOBER 1979 – REVISED JANUARY 2025

7.2.3 Application Curves

The following curves were generated with 5V on V_{CC} and V_{Logic} , $R_{PULLUP} = 5.1k\Omega$, and 50pF scope probe.

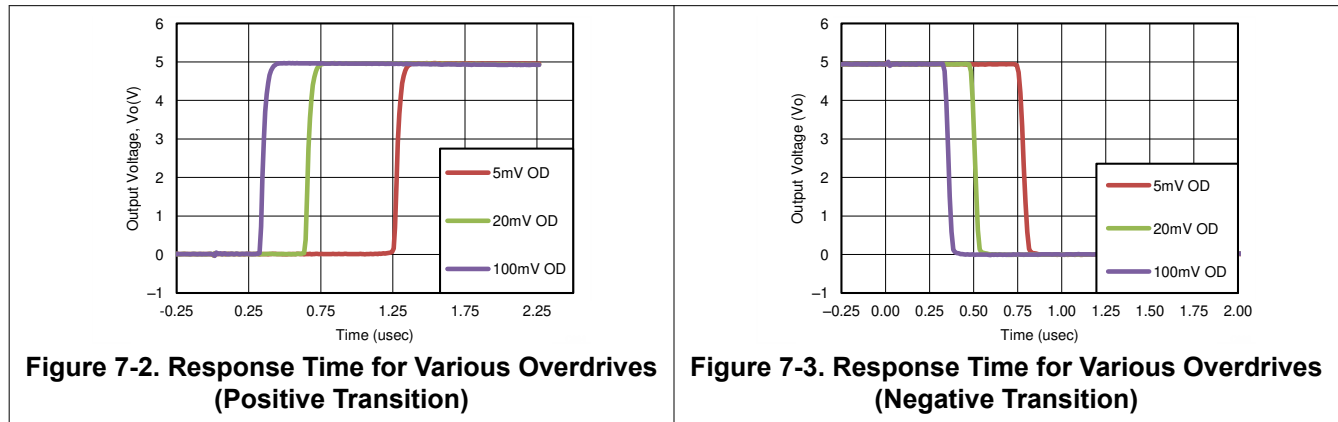

7.2.4 Power Supply Recommendations

For fast response and comparison applications with noisy or AC inputs, TI recommends to use a bypass capacitor on the supply pin to reject any variation on the supply voltage. This variation can eat into the input common-mode range of the comparator and create an inaccurate comparison.

7.2.5 Layout

7.2.5.1 Layout Guidelines

For accurate comparator applications without hysteresis maintaining a stable power supply with minimized noise and glitches is critical. Best practice is to add a bypass capacitor between the supply voltage and ground. This can be implemented on the positive power supply and negative supply (if available). If a negative supply is not being used, do not put a capacitor between the IC's GND pin and system ground.

Minimize coupling between outputs and inverting inputs to prevent output oscillations. Do not run output and inverting input traces in parallel unless there is a V_{CC} or GND trace between output and inverting input traces to reduce coupling. When series resistance is added to inputs, place resistor close to the device.

7.2.5.2 Layout Example

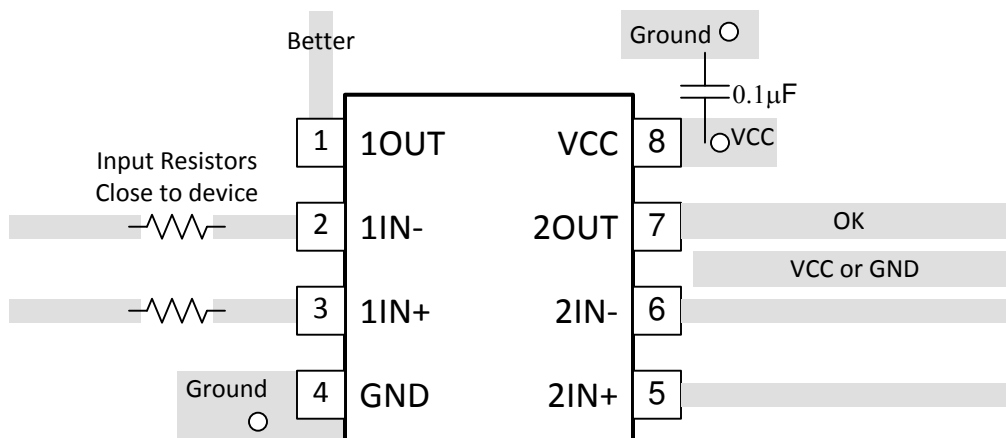

Figure 7-4. LM2903 Layout Example

8 Device and Documentation Support

8.1 Receiving Notification of Documentation Updates

To receive notification of documentation updates, navigate to the device product folder on [ti.com](https://www.ti.com). Click on *Notifications* to register and receive a weekly digest of any product information that has changed. For change details, review the revision history included in any revised document.

8.2 Support Resources

[TI E2E™ support forums](#) are an engineer's go-to source for fast, verified answers and design help — straight from the experts. Search existing answers or ask your own question to get the quick design help you need.

Linked content is provided "AS IS" by the respective contributors. They do not constitute TI specifications and do not necessarily reflect TI's views; see TI's [Terms of Use](#).

8.3 Trademarks

TI E2E™ is a trademark of Texas Instruments.
All trademarks are the property of their respective owners.

8.4 Electrostatic Discharge Caution



This integrated circuit can be damaged by ESD. Texas Instruments recommends that all integrated circuits be handled with appropriate precautions. Failure to observe proper handling and installation procedures can cause damage.

ESD damage can range from subtle performance degradation to complete device failure. Precision integrated circuits may be more susceptible to damage because very small parametric changes could cause the device not to meet its published specifications.

8.5 Glossary

[TI Glossary](#) This glossary lists and explains terms, acronyms, and definitions.

9 Revision History

NOTE: Page numbers for previous revisions may differ from page numbers in the current version.

Changes from Revision AF (August 2023) to Revision AG (January 2025)	Page
• Removed legacy device graphs.....	11
• Updated internal <i>Schematic</i>	17

Changes from Revision AE (November 2020) to Revision AF (August 2023)	Page
• Added reference to Application Note.....	18

Changes from Revision AD (October 2020) to Revision AE (November 2020)	Page
• Corrected Family Comparison Table Offset Voltage units to mV.....	1
• LM393B and LM2903B recommended minimum supply voltage changed to 2V throughout.....	1
• Added separate offset voltage row for LM393B and LM2903B DGK package.....	1
• Changed "B" devices recommended minimum supply voltage to 2V.....	4
• Updated "B" device Supply Current vs Supply Voltage Graph for 2V.....	11

Changes from Revision AC (February 2020) to Revision AD (October 2020)	Page
• Updated the numbering format for tables, figures and cross-references throughout the document.....	1

Changes from Revision AB (December 2019) to Revision AC (February 2020)	Page
• Changed front page Features, Applications and Description text to highlight B version.....	1
• Added WSON and SOT-23-8 packages.....	1
• Added Links to Family Table	1
• Added DDF and DSG pkgs to Thermal Table.....	5

Changes from Revision AA (September 2019) to Revision AB (December 2019)	Page
• Changed LM393B and LM2903B from Preview to Active status.....	1
• Added Family Comparison Table.....	1

Changes from Revision Z (October 2017) to Revision AA (September 2019)	Page
• Added "B" devices with various text changes throughout data sheet.....	1
• Deleted from Device Information old LM193 CDIP and LCCC package references and drawings. These are on the LM139-MIL data sheet.....	1
• Added "B" devices Thermal Information table.....	5
• Added "B" device electrical tables.....	5
• Added "B" device graphs	11

10 Mechanical, Packaging, and Orderable Information

The following pages include mechanical, packaging, and orderable information. This information is the most current data available for the designated devices. This data is subject to change without notice and revision of this document. For browser based versions of this data sheet, refer to the left hand navigation.

PACKAGING INFORMATION

Orderable Device	Status (1)	Package Type	Package Drawing	Pins	Package Qty	Eco Plan (2)	Lead finish/ Ball material (6)	MSL Peak Temp (3)	Op Temp (°C)	Device Marking (4/5)	Samples
LM193DR	ACTIVE	SOIC	D	8	2500	RoHS & Green	NIPDAU	Level-1-260C-UNLIM	-55 to 125	LM193	Samples
LM193DRG4	ACTIVE	SOIC	D	8	2500	RoHS & Green	NIPDAU	Level-1-260C-UNLIM	-55 to 125	LM193	Samples
LM2903AVQDR	ACTIVE	SOIC	D	8	2500	RoHS & Green	NIPDAU	Level-1-260C-UNLIM	-40 to 125	L2903AV	Samples
LM2903AVQDRG4	ACTIVE	SOIC	D	8	2500	RoHS & Green	NIPDAU	Level-1-260C-UNLIM	-40 to 125	L2903AV	Samples
LM2903AVQPWR	ACTIVE	TSSOP	PW	8	2000	RoHS & Green	NIPDAU	Level-1-260C-UNLIM	-40 to 125	L2903AV	Samples
LM2903AVQPWRG4	ACTIVE	TSSOP	PW	8	2000	RoHS & Green	NIPDAU	Level-1-260C-UNLIM	-40 to 125	L2903AV	Samples
LM2903BIDDFR	ACTIVE	SOT-23-THIN	DDF	8	3000	RoHS & Green	NIPDAU	Level-1-260C-UNLIM	-40 to 125	2903B	Samples
LM2903BIDGKR	ACTIVE	VSSOP	DGK	8	2500	RoHS & Green	NIPDAU	Level-1-260C-UNLIM	-40 to 125	903B	Samples
LM2903BIDR	ACTIVE	SOIC	D	8	2500	RoHS & Green	NIPDAU	Level-1-260C-UNLIM	-40 to 125	L2903B	Samples
LM2903BIDSGR	ACTIVE	WSON	DSG	8	3000	RoHS & Green	NIPDAU	Level-1-260C-UNLIM	-40 to 125	903B	Samples
LM2903BIPWR	ACTIVE	TSSOP	PW	8	2000	RoHS & Green	NIPDAU	Level-1-260C-UNLIM	-40 to 125	L2903B	Samples
LM2903DGKR	ACTIVE	VSSOP	DGK	8	2500	RoHS & Green	NIPDAU SN NIPDAUAG	Level-1-260C-UNLIM	-40 to 125	(MAP, MAS, MAU)	Samples
LM2903DR	ACTIVE	SOIC	D	8	2500	RoHS & Green	NIPDAU SN	Level-1-260C-UNLIM	-40 to 125	LM2903	Samples
LM2903DRG3	ACTIVE	SOIC	D	8	2500	RoHS & Green	SN	Level-1-260C-UNLIM	-40 to 125	LM2903	Samples
LM2903P	ACTIVE	PDIP	P	8	50	RoHS & Green	NIPDAU	N / A for Pkg Type	-40 to 125	LM2903P	Samples
LM2903PSR	ACTIVE	SO	PS	8	2000	RoHS & Green	NIPDAU	Level-1-260C-UNLIM	-40 to 125	L2903	Samples
LM2903PWR	ACTIVE	TSSOP	PW	8	2000	RoHS & Green	NIPDAU SN	Level-1-260C-UNLIM	-40 to 125	L2903	Samples
LM2903PWRG3	ACTIVE	TSSOP	PW	8	2000	RoHS & Green	SN	Level-1-260C-UNLIM	-40 to 125	L2903	Samples
LM2903PWRG4	ACTIVE	TSSOP	PW	8	2000	RoHS & Green	NIPDAU	Level-1-260C-UNLIM	-40 to 125	L2903	Samples
LM2903QD	ACTIVE	SOIC	D	8	75	RoHS & Green	NIPDAU	Level-1-260C-UNLIM	-40 to 125	2903Q	Samples

Orderable Device	Status (1)	Package Type	Package Drawing	Pins	Package Qty	Eco Plan (2)	Lead finish/ Ball material (6)	MSL Peak Temp (3)	Op Temp (°C)	Device Marking (4/5)	Samples
LM2903QDRG4	OBSOLETE	SOIC	D	8		TBD	Call TI	Call TI	-40 to 125	2903Q	
LM2903VQDR	ACTIVE	SOIC	D	8	2500	RoHS & Green	NIPDAU	Level-1-260C-UNLIM	-40 to 125	L2903V	Samples
LM2903VQDRG4	OBSOLETE	SOIC	D	8		TBD	Call TI	Call TI	-40 to 125	L2903V	
LM2903VQPWR	ACTIVE	TSSOP	PW	8	2000	RoHS & Green	NIPDAU	Level-1-260C-UNLIM	-40 to 125	L2903V	Samples
LM2903VQPWRG4	OBSOLETE	TSSOP	PW	8		TBD	Call TI	Call TI	-40 to 125	L2903V	
LM293ADGKR	ACTIVE	VSSOP	DGK	8	2500	RoHS & Green	NIPDAU SN	Level-1-260C-UNLIM	-25 to 85	(MDP, MDS, MDU)	Samples
LM293ADGKRG4	ACTIVE	VSSOP	DGK	8	2500	TBD	Call TI	Call TI	-25 to 85		Samples
LM293ADR	ACTIVE	SOIC	D	8	2500	RoHS & Green	NIPDAU	Level-1-260C-UNLIM	-25 to 85	LM293A	Samples
LM293D	OBSOLETE	SOIC	D	8		TBD	Call TI	Call TI	-25 to 85	LM293	
LM293DGKR	ACTIVE	VSSOP	DGK	8	2500	RoHS & Green	NIPDAU SN	Level-2-260C-1 YEAR	-25 to 85	(MCP, MCS, MCU)	Samples
LM293DGKRG4	ACTIVE	VSSOP	DGK	8	2500	TBD	Call TI	Call TI	-25 to 85		Samples
LM293DR	ACTIVE	SOIC	D	8	2500	RoHS & Green	NIPDAU SN	Level-1-260C-UNLIM	-25 to 85	LM293	Samples
LM293DRG3	ACTIVE	SOIC	D	8	2500	RoHS & Green	SN	Level-1-260C-UNLIM	-25 to 85	LM293	Samples
LM293P	ACTIVE	PDIP	P	8	50	RoHS & Green	NIPDAU	N / A for Pkg Type	-25 to 85	LM293P	Samples
LM293PE4	ACTIVE	PDIP	P	8	50	TBD	Call TI	Call TI	-25 to 85		Samples
LM393ADGKR	ACTIVE	VSSOP	DGK	8	2500	RoHS & Green	NIPDAU NIPDAUAG	Level-1-260C-UNLIM	0 to 70	(M8P, M8S, M8U)	Samples
LM393ADGKRG4	ACTIVE	VSSOP	DGK	8	2500	TBD	Call TI	Call TI	0 to 70		Samples
LM393ADR	ACTIVE	SOIC	D	8	2500	RoHS & Green	NIPDAU SN	Level-1-260C-UNLIM	0 to 70	LM393A	Samples
LM393ADRG4	OBSOLETE	SOIC	D	8		TBD	Call TI	Call TI	0 to 70	LM393A	
LM393AP	ACTIVE	PDIP	P	8	50	RoHS & Green	NIPDAU SN	N / A for Pkg Type	0 to 70	LM393AP	Samples
LM393APE4	ACTIVE	PDIP	P	8	50	TBD	Call TI	Call TI	0 to 70		Samples
LM393APSR	ACTIVE	SO	PS	8	2000	RoHS & Green	NIPDAU	Level-1-260C-UNLIM	0 to 70	L393A	Samples
LM393APWR	ACTIVE	TSSOP	PW	8	2000	RoHS & Green	NIPDAU SN	Level-1-260C-UNLIM	0 to 70	L393A	Samples

Orderable Device	Status (1)	Package Type	Package Drawing	Pins	Package Qty	Eco Plan (2)	Lead finish/ Ball material (6)	MSL Peak Temp (3)	Op Temp (°C)	Device Marking (4/5)	Samples
LM393APWRG4	OBSOLETE	TSSOP	PW	8		TBD	Call TI	Call TI	0 to 70	L393A	
LM393BIDDFR	ACTIVE	SOT-23-THIN	DDF	8	3000	RoHS & Green	NIPDAU	Level-1-260C-UNLIM	-40 to 85	393B	Samples
LM393BIDGKR	ACTIVE	VSSOP	DGK	8	2500	RoHS & Green	NIPDAU	Level-1-260C-UNLIM	-40 to 85	393B	Samples
LM393BIDR	ACTIVE	SOIC	D	8	2500	RoHS & Green	NIPDAU	Level-1-260C-UNLIM	-40 to 85	LM393B	Samples
LM393BIDSGR	ACTIVE	WSON	DSG	8	3000	RoHS & Green	NIPDAU	Level-1-260C-UNLIM	-40 to 85	393B	Samples
LM393BIPWR	ACTIVE	TSSOP	PW	8	2000	RoHS & Green	NIPDAU	Level-1-260C-UNLIM	-40 to 85	LM393B	Samples
LM393D	OBSOLETE	SOIC	D	8		TBD	Call TI	Call TI	0 to 70	LM393	
LM393DGKR	ACTIVE	VSSOP	DGK	8	2500	RoHS & Green	NIPDAU SN	Level-1-260C-UNLIM	0 to 70	(M9P, M9S, M9U)	Samples
LM393DGKRG4	ACTIVE	VSSOP	DGK	8	2500	TBD	Call TI	Call TI	0 to 70		Samples
LM393DR	ACTIVE	SOIC	D	8	2500	RoHS & Green	NIPDAU	Level-1-260C-UNLIM	0 to 70	LM393	Samples
LM393DRG3	ACTIVE	SOIC	D	8	2500	RoHS & Green	SN	Level-1-260C-UNLIM	0 to 70	LM393	Samples
LM393DRG4	OBSOLETE	SOIC	D	8		TBD	Call TI	Call TI	0 to 70	LM393	
LM393P	ACTIVE	PDIP	P	8	50	RoHS & Green	NIPDAU SN	N / A for Pkg Type	0 to 70	LM393P	Samples
LM393PE3	ACTIVE	PDIP	P	8	50	RoHS & Non-Green	SN	N / A for Pkg Type	0 to 70	LM393P	Samples
LM393PE4	ACTIVE	PDIP	P	8	50	RoHS & Green	NIPDAU	N / A for Pkg Type	0 to 70	LM393P	Samples
LM393PS	ACTIVE	SO	PS	8	80	RoHS & Green	NIPDAU	Level-1-260C-UNLIM	0 to 70	L393	Samples
LM393PSR	ACTIVE	SO	PS	8	2000	RoHS & Green	NIPDAU	Level-1-260C-UNLIM	0 to 70	L393	Samples
LM393PSRG4	ACTIVE	SO	PS	8	2000	RoHS & Green	NIPDAU	Level-1-260C-UNLIM	0 to 70	L393	Samples
LM393PWR	ACTIVE	TSSOP	PW	8	2000	RoHS & Green	NIPDAU SN	Level-1-260C-UNLIM	0 to 70	L393	Samples
LM393PWRG3	ACTIVE	TSSOP	PW	8	2000	RoHS & Green	SN	Level-1-260C-UNLIM	0 to 70	L393	Samples
LM393PWRG4	ACTIVE	TSSOP	PW	8	2000	RoHS & Green	NIPDAU	Level-1-260C-UNLIM	0 to 70	L393	Samples

(1) The marketing status values are defined as follows:

ACTIVE: Product device recommended for new designs.

LIFEBUY: TI has announced that the device will be discontinued, and a lifetime-buy period is in effect.

NRND: Not recommended for new designs. Device is in production to support existing customers, but TI does not recommend using this part in a new design.

PREVIEW: Device has been announced but is not in production. Samples may or may not be available.

OBSOLETE: TI has discontinued the production of the device.

⁽²⁾ **RoHS:** TI defines "RoHS" to mean semiconductor products that are compliant with the current EU RoHS requirements for all 10 RoHS substances, including the requirement that RoHS substance do not exceed 0.1% by weight in homogeneous materials. Where designed to be soldered at high temperatures, "RoHS" products are suitable for use in specified lead-free processes. TI may reference these types of products as "Pb-Free".

RoHS Exempt: TI defines "RoHS Exempt" to mean products that contain lead but are compliant with EU RoHS pursuant to a specific EU RoHS exemption.

Green: TI defines "Green" to mean the content of Chlorine (Cl) and Bromine (Br) based flame retardants meet JS709B low halogen requirements of <=1000ppm threshold. Antimony trioxide based flame retardants must also meet the <=1000ppm threshold requirement.

⁽³⁾ MSL, Peak Temp. - The Moisture Sensitivity Level rating according to the JEDEC industry standard classifications, and peak solder temperature.

⁽⁴⁾ There may be additional marking, which relates to the logo, the lot trace code information, or the environmental category on the device.

⁽⁵⁾ Multiple Device Markings will be inside parentheses. Only one Device Marking contained in parentheses and separated by a "~" will appear on a device. If a line is indented then it is a continuation of the previous line and the two combined represent the entire Device Marking for that device.

⁽⁶⁾ Lead finish/Ball material - Orderable Devices may have multiple material finish options. Finish options are separated by a vertical ruled line. Lead finish/Ball material values may wrap to two lines if the finish value exceeds the maximum column width.

Important Information and Disclaimer:The information provided on this page represents TI's knowledge and belief as of the date that it is provided. TI bases its knowledge and belief on information provided by third parties, and makes no representation or warranty as to the accuracy of such information. Efforts are underway to better integrate information from third parties. TI has taken and continues to take reasonable steps to provide representative and accurate information but may not have conducted destructive testing or chemical analysis on incoming materials and chemicals. TI and TI suppliers consider certain information to be proprietary, and thus CAS numbers and other limited information may not be available for release.

In no event shall TI's liability arising out of such information exceed the total purchase price of the TI part(s) at issue in this document sold by TI to Customer on an annual basis.

OTHER QUALIFIED VERSIONS OF LM2903, LM2903B, LM293 :

● Automotive : [LM2903-Q1](#), [LM2903B-Q1](#)

● Enhanced Product : [LM293-EP](#)

NOTE: Qualified Version Definitions:

● Automotive - Q100 devices qualified for high-reliability automotive applications targeting zero defects

- Enhanced Product - Supports Defense, Aerospace and Medical Applications

TAPE AND REEL INFORMATION

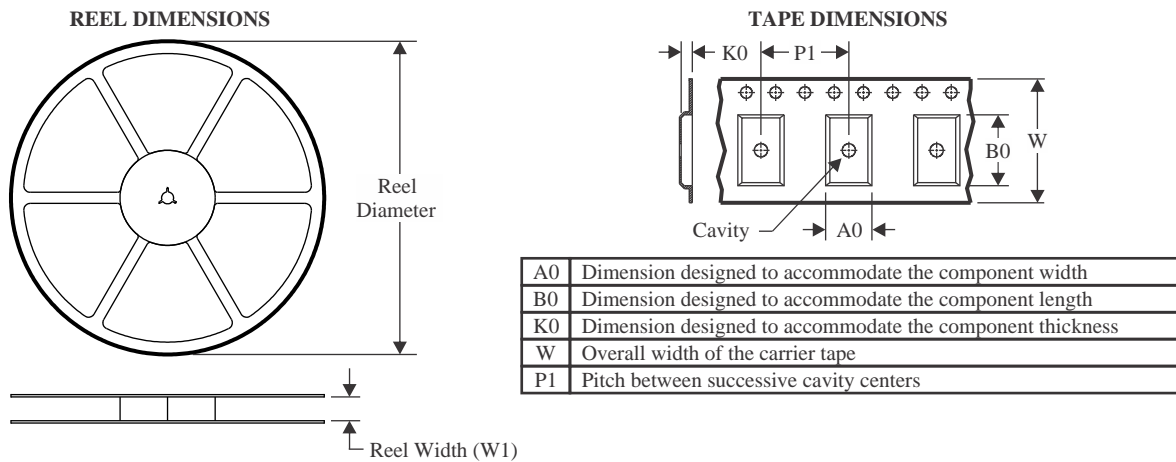

QUADRANT ASSIGNMENTS FOR PIN 1 ORIENTATION IN TAPE

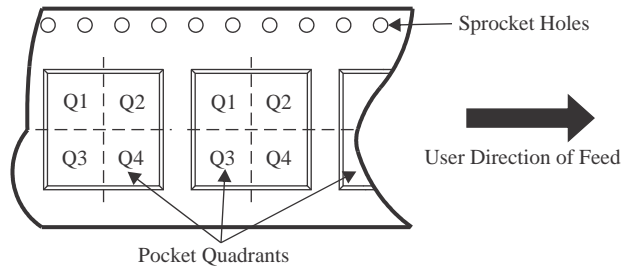

*All dimensions are nominal

Device	Package Type	Package Drawing	Pins	SPQ	Reel Diameter (mm)	Reel Width W1 (mm)	A0 (mm)	B0 (mm)	K0 (mm)	P1 (mm)	W (mm)	Pin1 Quadrant
LM193DR	SOIC	D	8	2500	330.0	12.4	6.4	5.2	2.1	8.0	12.0	Q1
LM193DRG4	SOIC	D	8	2500	330.0	12.4	6.4	5.2	2.1	8.0	12.0	Q1
LM2903AVQDR	SOIC	D	8	2500	330.0	12.4	6.4	5.2	2.1	8.0	12.0	Q1
LM2903AVQDRG4	SOIC	D	8	2500	330.0	12.4	6.4	5.2	2.1	8.0	12.0	Q1
LM2903AVQPWR	TSSOP	PW	8	2000	330.0	12.4	7.0	3.6	1.6	8.0	12.0	Q1
LM2903AVQPWRG4	TSSOP	PW	8	2000	330.0	12.4	7.0	3.6	1.6	8.0	12.0	Q1
LM2903BIDDFR	SOT-23-THIN	DDF	8	3000	180.0	8.4	3.2	3.2	1.4	4.0	8.0	Q3
LM2903BIDGKR	VSSOP	DGK	8	2500	330.0	12.4	5.3	3.4	1.4	8.0	12.0	Q1
LM2903BIDR	SOIC	D	8	2500	330.0	12.4	6.4	5.2	2.1	8.0	12.0	Q1
LM2903BIDSGR	WSOIC	DSG	8	3000	180.0	8.4	2.3	2.3	1.15	4.0	8.0	Q2
LM2903BIPWR	TSSOP	PW	8	2000	330.0	12.4	7.0	3.6	1.6	8.0	12.0	Q1
LM2903DGKR	VSSOP	DGK	8	2500	330.0	12.4	6.4	5.2	2.1	8.0	12.0	Q1
LM2903DGKR	VSSOP	DGK	8	2500	330.0	12.4	5.3	3.4	1.4	8.0	12.0	Q1
LM2903DR	SOIC	D	8	2500	330.0	12.4	6.4	5.2	2.1	8.0	12.0	Q1
LM2903DR	SOIC	D	8	2500	330.0	12.4	6.4	5.2	2.1	8.0	12.0	Q1



PACKAGE MATERIALS INFORMATION

www.ti.com

26-Feb-2025

Device	Package Type	Package Drawing	Pins	SPQ	Reel Diameter (mm)	Reel Width W1 (mm)	A0 (mm)	B0 (mm)	K0 (mm)	P1 (mm)	W (mm)	Pin1 Quadrant
LM2903DR	SOIC	D	8	2500	330.0	12.4	6.4	5.2	2.1	8.0	12.0	Q1
LM2903DR	SOIC	D	8	2500	330.0	12.4	6.4	5.2	2.1	8.0	12.0	Q1
LM2903DRG3	SOIC	D	8	2500	330.0	12.8	6.4	5.2	2.1	8.0	12.0	Q1
LM2903PSR	SO	PS	8	2000	330.0	16.4	8.35	6.6	2.4	12.0	16.0	Q1
LM2903PWR	TSSOP	PW	8	2000	330.0	12.4	7.0	3.6	1.6	8.0	12.0	Q1
LM2903PWR	TSSOP	PW	8	2000	330.0	12.4	7.0	3.6	1.6	8.0	12.0	Q1
LM2903PWRG3	TSSOP	PW	8	2000	330.0	12.4	7.0	3.6	1.6	8.0	12.0	Q1
LM2903PWRG4	TSSOP	PW	8	2000	330.0	12.4	7.0	3.6	1.6	8.0	12.0	Q1
LM2903VQDR	SOIC	D	8	2500	330.0	12.4	6.4	5.2	2.1	8.0	12.0	Q1
LM2903VQPWR	TSSOP	PW	8	2000	330.0	12.4	7.0	3.6	1.6	8.0	12.0	Q1
LM2903VQPWR	TSSOP	PW	8	2000	330.0	12.4	7.0	3.6	1.6	8.0	12.0	Q1
LM293ADGKR	VSSOP	DGK	8	2500	330.0	12.4	5.25	3.35	1.25	8.0	12.0	Q1
LM293ADGKR	VSSOP	DGK	8	2500	330.0	12.4	5.3	3.4	1.4	8.0	12.0	Q1
LM293ADGKR	VSSOP	DGK	8	2500	330.0	12.4	5.3	3.3	1.3	8.0	12.0	Q1
LM293ADR	SOIC	D	8	2500	330.0	12.4	6.4	5.2	2.1	8.0	12.0	Q1
LM293ADR	SOIC	D	8	2500	330.0	12.4	6.4	5.2	2.1	8.0	12.0	Q1
LM293DGKR	VSSOP	DGK	8	2500	330.0	12.4	5.3	3.4	1.4	8.0	12.0	Q1
LM293DGKR	VSSOP	DGK	8	2500	330.0	12.4	5.3	3.3	1.3	8.0	12.0	Q1
LM293DGKR	VSSOP	DGK	8	2500	330.0	12.4	5.3	3.4	1.4	8.0	12.0	Q1
LM293DGKR	VSSOP	DGK	8	2500	330.0	12.4	5.25	3.35	1.25	8.0	12.0	Q1
LM293DGKR	VSSOP	DGK	8	2500	330.0	12.4	5.3	3.4	1.4	8.0	12.0	Q1
LM293DR	SOIC	D	8	2500	330.0	12.4	6.4	5.2	2.1	8.0	12.0	Q1
LM293DR	SOIC	D	8	2500	330.0	12.4	6.4	5.2	2.1	8.0	12.0	Q1
LM293DR	SOIC	D	8	2500	330.0	12.4	6.4	5.2	2.1	8.0	12.0	Q1
LM293DRG3	SOIC	D	8	2500	330.0	12.8	6.4	5.2	2.1	8.0	12.0	Q1
LM393ADGKR	VSSOP	DGK	8	2500	330.0	12.4	5.3	3.4	1.4	8.0	12.0	Q1
LM393ADGKR	VSSOP	DGK	8	2500	330.0	12.4	5.3	3.4	1.4	8.0	12.0	Q1
LM393ADGKR	VSSOP	DGK	8	2500	330.0	12.4	5.3	3.3	1.3	8.0	12.0	Q1
LM393ADR	SOIC	D	8	2500	330.0	12.4	6.4	5.2	2.1	8.0	12.0	Q1
LM393ADR	SOIC	D	8	2500	330.0	12.4	6.4	5.2	2.1	8.0	12.0	Q1
LM393ADR	SOIC	D	8	2500	330.0	12.4	6.4	5.2	2.1	8.0	12.0	Q1
LM393APSR	SO	PS	8	2000	330.0	16.4	8.35	6.6	2.4	12.0	16.0	Q1
LM393APWR	TSSOP	PW	8	2000	330.0	12.4	7.0	3.6	1.6	8.0	12.0	Q1
LM393APWR	TSSOP	PW	8	2000	330.0	12.4	7.0	3.6	1.6	8.0	12.0	Q1
LM393BIDDFR	SOT-23-THIN	DDF	8	3000	180.0	8.4	3.2	3.2	1.4	4.0	8.0	Q3
LM393BIDGKR	VSSOP	DGK	8	2500	330.0	12.4	6.4	5.2	2.1	8.0	12.0	Q1
LM393BIDR	SOIC	D	8	2500	330.0	12.4	6.4	5.2	2.1	8.0	12.0	Q1
LM393BIDSGR	WSO	DSG	8	3000	180.0	8.4	2.3	2.3	1.15	4.0	8.0	Q2
LM393BIPWR	TSSOP	PW	8	2000	330.0	12.4	7.0	3.6	1.6	8.0	12.0	Q1
LM393DGKR	VSSOP	DGK	8	2500	330.0	12.4	5.3	3.4	1.4	8.0	12.0	Q1
LM393DGKR	VSSOP	DGK	8	2500	330.0	12.4	5.3	3.4	1.4	8.0	12.0	Q1



PACKAGE MATERIALS INFORMATION

www.ti.com

26-Feb-2025

Device	Package Type	Package Drawing	Pins	SPQ	Reel Diameter (mm)	Reel Width W1 (mm)	A0 (mm)	B0 (mm)	K0 (mm)	P1 (mm)	W (mm)	Pin1 Quadrant
LM393DGKR	VSSOP	DGK	8	2500	330.0	12.4	5.3	3.3	1.3	8.0	12.0	Q1
LM393DGKR	VSSOP	DGK	8	2500	330.0	12.4	5.3	3.4	1.4	8.0	12.0	Q1
LM393DGKR	VSSOP	DGK	8	2500	330.0	12.4	5.25	3.35	1.25	8.0	12.0	Q1
LM393DR	SOIC	D	8	2500	330.0	12.4	6.4	5.2	2.1	8.0	12.0	Q1
LM393DR	SOIC	D	8	2500	330.0	12.4	6.4	5.2	2.1	8.0	12.0	Q1
LM393DR	SOIC	D	8	2500	330.0	12.4	6.4	5.2	2.1	8.0	12.0	Q1
LM393DR	SOIC	D	8	2500	330.0	12.4	6.4	5.2	2.1	8.0	12.0	Q1
LM393DRG3	SOIC	D	8	2500	330.0	12.8	6.4	5.2	2.1	8.0	12.0	Q1
LM393PSR	SO	PS	8	2000	330.0	16.4	8.35	6.6	2.4	12.0	16.0	Q1
LM393PWR	TSSOP	PW	8	2000	330.0	12.4	7.0	3.6	1.6	8.0	12.0	Q1
LM393PWRG3	TSSOP	PW	8	2000	330.0	12.4	7.0	3.6	1.6	8.0	12.0	Q1
LM393PWRG4	TSSOP	PW	8	2000	330.0	12.4	7.0	3.6	1.6	8.0	12.0	Q1

TAPE AND REEL BOX DIMENSIONS

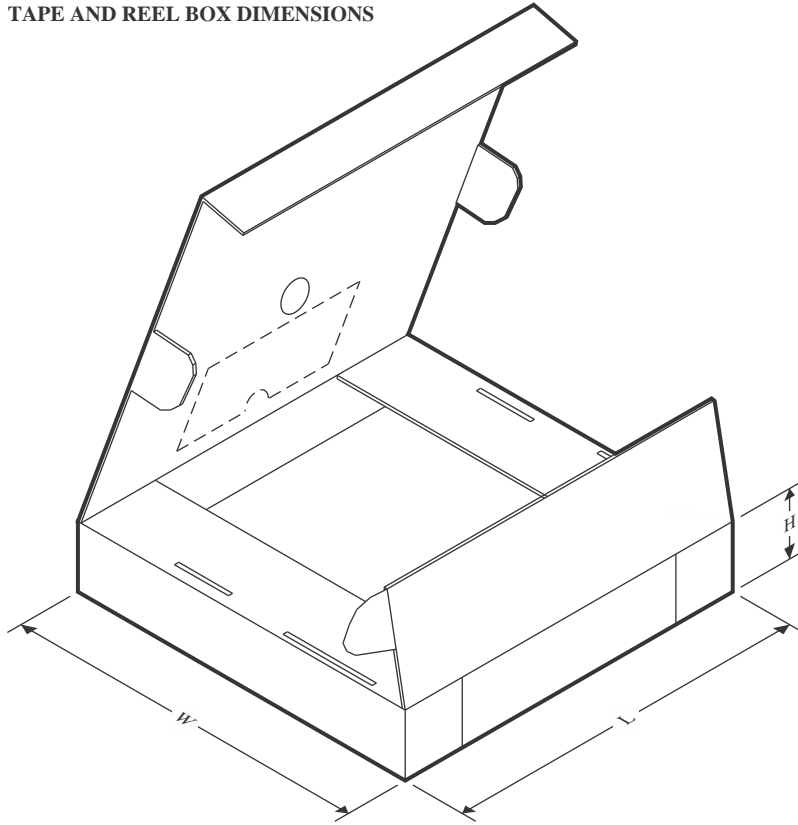

*All dimensions are nominal

Device	Package Type	Package Drawing	Pins	SPQ	Length (mm)	Width (mm)	Height (mm)
LM193DR	SOIC	D	8	2500	353.0	353.0	32.0
LM193DRG4	SOIC	D	8	2500	353.0	353.0	32.0
LM2903AVQDR	SOIC	D	8	2500	353.0	353.0	32.0
LM2903AVQDRG4	SOIC	D	8	2500	353.0	353.0	32.0
LM2903AVQPWR	TSSOP	PW	8	2000	356.0	356.0	35.0
LM2903AVQPWRG4	TSSOP	PW	8	2000	356.0	356.0	35.0
LM2903BIDDFR	SOT-23-THIN	DDF	8	3000	210.0	185.0	35.0
LM2903BIDGKR	VSSOP	DGK	8	2500	353.0	353.0	32.0
LM2903BIDR	SOIC	D	8	2500	353.0	353.0	32.0
LM2903BIDSGR	WSON	DSG	8	3000	210.0	185.0	35.0
LM2903BIPWR	TSSOP	PW	8	2000	356.0	356.0	35.0
LM2903DGKR	VSSOP	DGK	8	2500	353.0	353.0	32.0
LM2903DGKR	VSSOP	DGK	8	2500	356.0	356.0	35.0
LM2903DR	SOIC	D	8	2500	340.5	338.1	20.6
LM2903DR	SOIC	D	8	2500	353.0	353.0	32.0
LM2903DR	SOIC	D	8	2500	353.0	353.0	32.0
LM2903DR	SOIC	D	8	2500	356.0	356.0	35.0
LM2903DRG3	SOIC	D	8	2500	364.0	364.0	27.0



PACKAGE MATERIALS INFORMATION

www.ti.com

26-Feb-2025

Device	Package Type	Package Drawing	Pins	SPQ	Length (mm)	Width (mm)	Height (mm)
LM2903PSR	SO	PS	8	2000	356.0	356.0	35.0
LM2903PWR	TSSOP	PW	8	2000	356.0	356.0	35.0
LM2903PWR	TSSOP	PW	8	2000	356.0	356.0	35.0
LM2903PWRG3	TSSOP	PW	8	2000	364.0	364.0	27.0
LM2903PWRG4	TSSOP	PW	8	2000	356.0	356.0	35.0
LM2903VQDR	SOIC	D	8	2500	353.0	353.0	32.0
LM2903VQPWR	TSSOP	PW	8	2000	356.0	356.0	35.0
LM2903VQPWR	TSSOP	PW	8	2000	356.0	356.0	35.0
LM293ADGKR	VSSOP	DGK	8	2500	366.0	364.0	50.0
LM293ADGKR	VSSOP	DGK	8	2500	358.0	335.0	35.0
LM293ADGKR	VSSOP	DGK	8	2500	370.0	355.0	55.0
LM293ADR	SOIC	D	8	2500	353.0	353.0	32.0
LM293ADR	SOIC	D	8	2500	356.0	356.0	35.0
LM293DGKR	VSSOP	DGK	8	2500	353.0	353.0	32.0
LM293DGKR	VSSOP	DGK	8	2500	370.0	355.0	55.0
LM293DGKR	VSSOP	DGK	8	2500	358.0	335.0	35.0
LM293DGKR	VSSOP	DGK	8	2500	366.0	364.0	50.0
LM293DGKR	VSSOP	DGK	8	2500	356.0	356.0	35.0
LM293DR	SOIC	D	8	2500	356.0	356.0	35.0
LM293DR	SOIC	D	8	2500	353.0	353.0	32.0
LM293DR	SOIC	D	8	2500	356.0	356.0	35.0
LM293DRG3	SOIC	D	8	2500	364.0	364.0	27.0
LM393ADGKR	VSSOP	DGK	8	2500	358.0	335.0	35.0
LM393ADGKR	VSSOP	DGK	8	2500	364.0	364.0	27.0
LM393ADGKR	VSSOP	DGK	8	2500	346.0	346.0	35.0
LM393ADR	SOIC	D	8	2500	356.0	356.0	35.0
LM393ADR	SOIC	D	8	2500	353.0	353.0	32.0
LM393ADR	SOIC	D	8	2500	356.0	356.0	35.0
LM393APSR	SO	PS	8	2000	356.0	356.0	35.0
LM393APWR	TSSOP	PW	8	2000	356.0	356.0	35.0
LM393APWR	TSSOP	PW	8	2000	356.0	356.0	35.0
LM393BIDDFR	SOT-23-THIN	DDF	8	3000	210.0	185.0	35.0
LM393BIDGKR	VSSOP	DGK	8	2500	353.0	353.0	32.0
LM393BIDR	SOIC	D	8	2500	353.0	353.0	32.0
LM393BIDSGR	WSON	DSG	8	3000	210.0	185.0	35.0
LM393BIPWR	TSSOP	PW	8	2000	356.0	356.0	35.0
LM393DGKR	VSSOP	DGK	8	2500	356.0	356.0	35.0
LM393DGKR	VSSOP	DGK	8	2500	358.0	335.0	35.0
LM393DGKR	VSSOP	DGK	8	2500	346.0	346.0	35.0
LM393DGKR	VSSOP	DGK	8	2500	353.0	353.0	32.0
LM393DGKR	VSSOP	DGK	8	2500	366.0	364.0	50.0
LM393DR	SOIC	D	8	2500	353.0	353.0	32.0
LM393DR	SOIC	D	8	2500	340.5	338.1	20.6



PACKAGE MATERIALS INFORMATION

www.ti.com

26-Feb-2025

Device	Package Type	Package Drawing	Pins	SPQ	Length (mm)	Width (mm)	Height (mm)
LM393DR	SOIC	D	8	2500	356.0	356.0	35.0
LM393DR	SOIC	D	8	2500	353.0	353.0	32.0
LM393DRG3	SOIC	D	8	2500	364.0	364.0	27.0
LM393PSR	SO	PS	8	2000	356.0	356.0	35.0
LM393PWR	TSSOP	PW	8	2000	356.0	356.0	35.0
LM393PWRG3	TSSOP	PW	8	2000	364.0	364.0	27.0
LM393PWRG4	TSSOP	PW	8	2000	356.0	356.0	35.0

TUBE

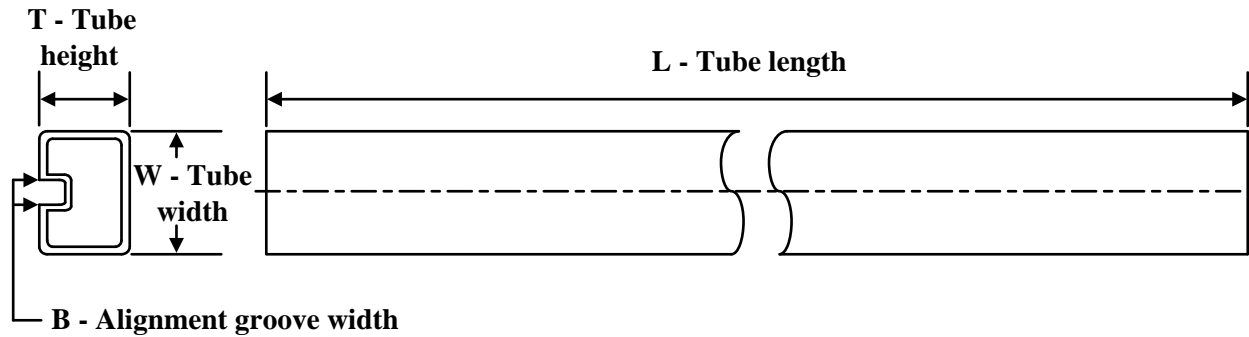

*All dimensions are nominal

Device	Package Name	Package Type	Pins	SPQ	L (mm)	W (mm)	T (μm)	B (mm)
LM2903P	P	PDIP	8	50	506	13.97	11230	4.32
LM2903QD	D	SOIC	8	75	505.46	6.76	3810	4
LM293P	P	PDIP	8	50	506	13.97	11230	4.32
LM393AP	P	PDIP	8	50	506.1	9	600	5.4
LM393AP	P	PDIP	8	50	506	13.97	11230	4.32
LM393P	P	PDIP	8	50	506	13.97	11230	4.32
LM393P	P	PDIP	8	50	506.1	9	600	5.4
LM393PE3	P	PDIP	8	50	506.1	9	600	5.4
LM393PE4	P	PDIP	8	50	506	13.97	11230	4.32
LM393PS	PS	SOP	8	80	530	10.5	4000	4.1



PACKAGE OUTLINE

DDF0008A

SOT-23-THIN - 1.1 mm max height

PLASTIC SMALL OUTLINE

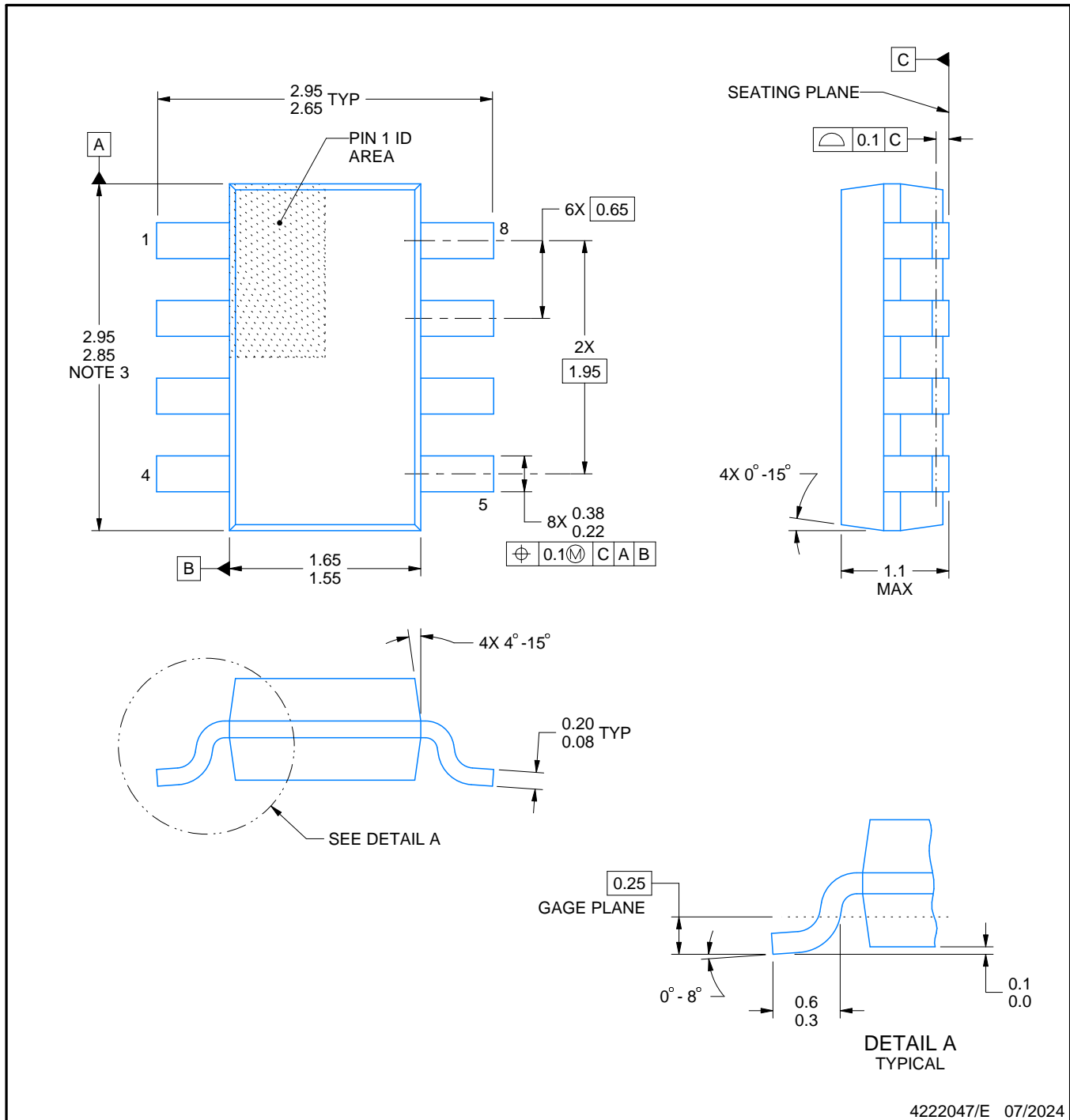

4222047/E 07/2024

NOTES:

1. All linear dimensions are in millimeters. Any dimensions in parenthesis are for reference only. Dimensioning and tolerancing per ASME Y14.5M.
2. This drawing is subject to change without notice.
3. This dimension does not include mold flash, protrusions, or gate burrs. Mold flash, protrusions, or gate burrs shall not exceed 0.15 mm per side.

EXAMPLE BOARD LAYOUT

DDF0008A

SOT-23-THIN - 1.1 mm max height

PLASTIC SMALL OUTLINE

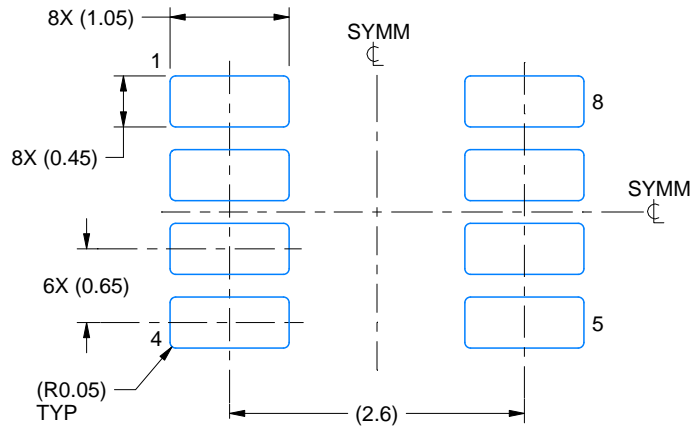

LAND PATTERN EXAMPLE
EXPOSED METAL SHOWN
SCALE:15X

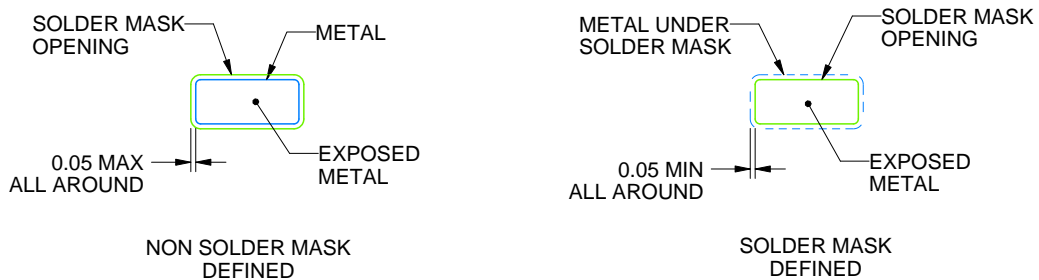

SOLDER MASK DETAILS

4222047/E 07/2024

NOTES: (continued)

- 4. Publication IPC-7351 may have alternate designs.
- 5. Solder mask tolerances between and around signal pads can vary based on board fabrication site.

EXAMPLE STENCIL DESIGN**DDF0008A****SOT-23-THIN - 1.1 mm max height**

PLASTIC SMALL OUTLINE

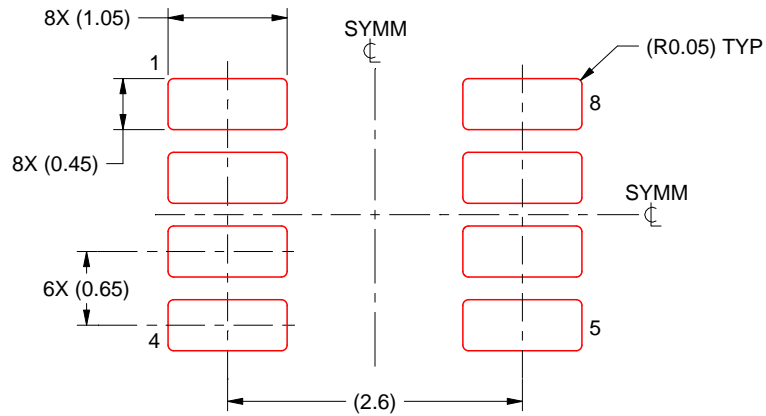

SOLDER PASTE EXAMPLE
 BASED ON 0.125 mm THICK STENCIL
 SCALE:15X

4222047/E 07/2024

NOTES: (continued)

6. Laser cutting apertures with trapezoidal walls and rounded corners may offer better paste release. IPC-7525 may have alternate design recommendations.
7. Board assembly site may have different recommendations for stencil design.

**D0008A****PACKAGE OUTLINE****SOIC - 1.75 mm max height**

SMALL OUTLINE INTEGRATED CIRCUIT

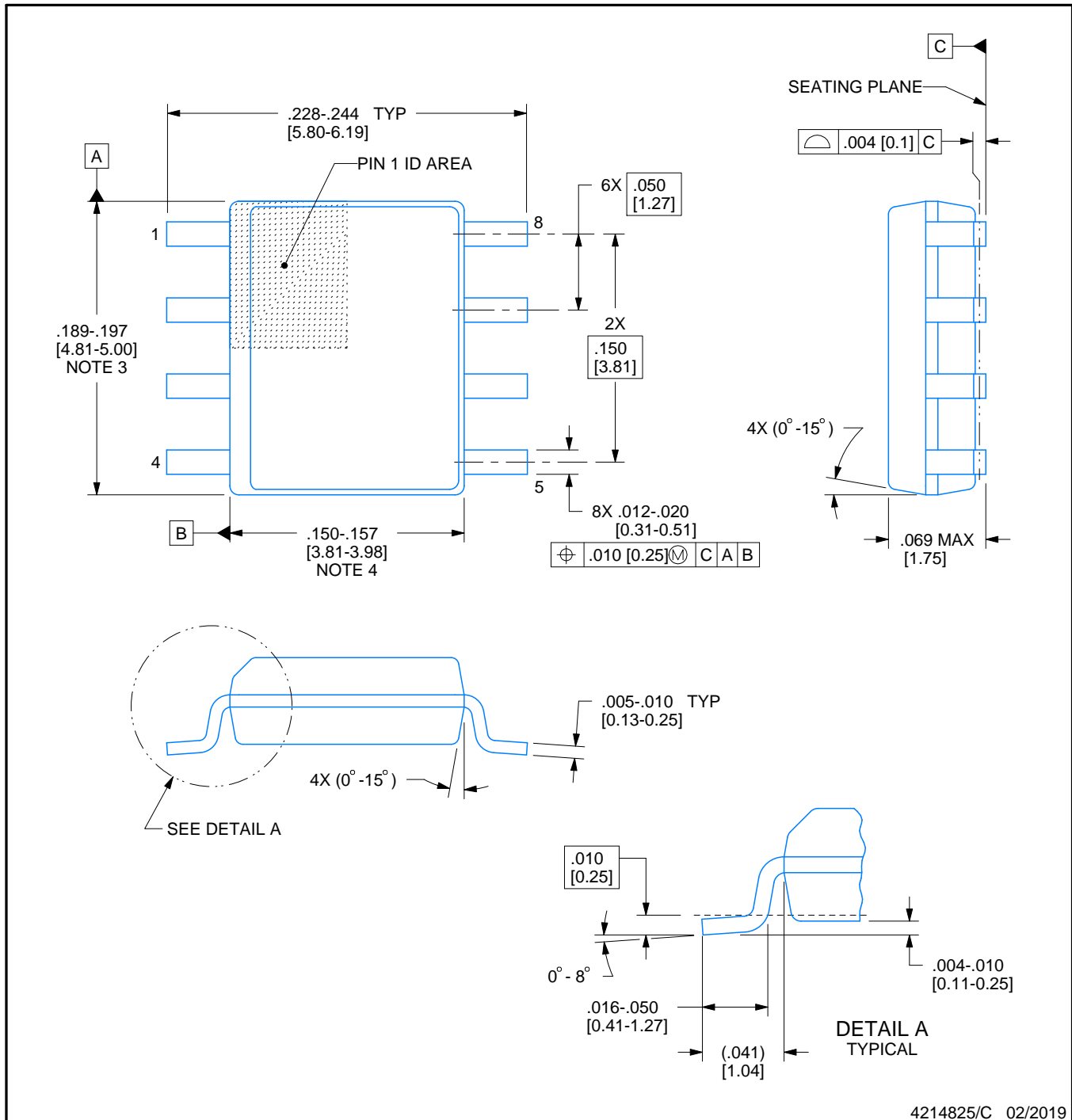
**NOTES:**

1. Linear dimensions are in inches [millimeters]. Dimensions in parenthesis are for reference only. Controlling dimensions are in inches. Dimensioning and tolerancing per ASME Y14.5M.
2. This drawing is subject to change without notice.
3. This dimension does not include mold flash, protrusions, or gate burrs. Mold flash, protrusions, or gate burrs shall not exceed $.006$ [0.15] per side.
4. This dimension does not include interlead flash.
5. Reference JEDEC registration MS-012, variation AA.

EXAMPLE BOARD LAYOUT**D0008A****SOIC - 1.75 mm max height**

SMALL OUTLINE INTEGRATED CIRCUIT

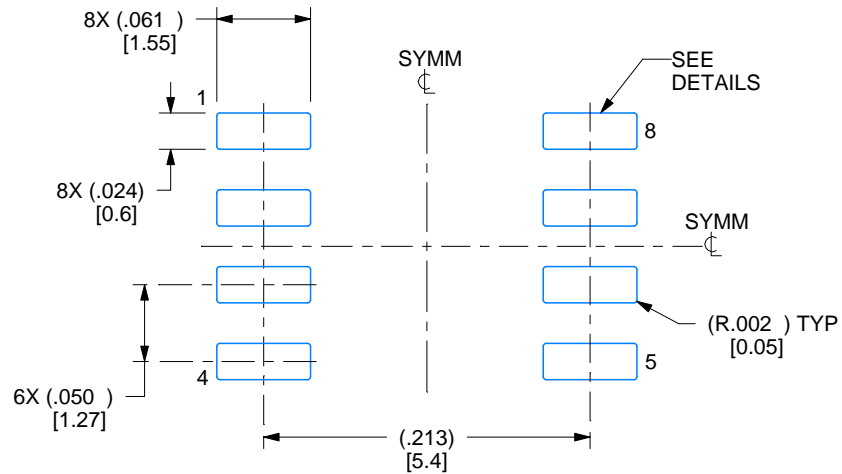

LAND PATTERN EXAMPLE
EXPOSED METAL SHOWN
SCALE:8X

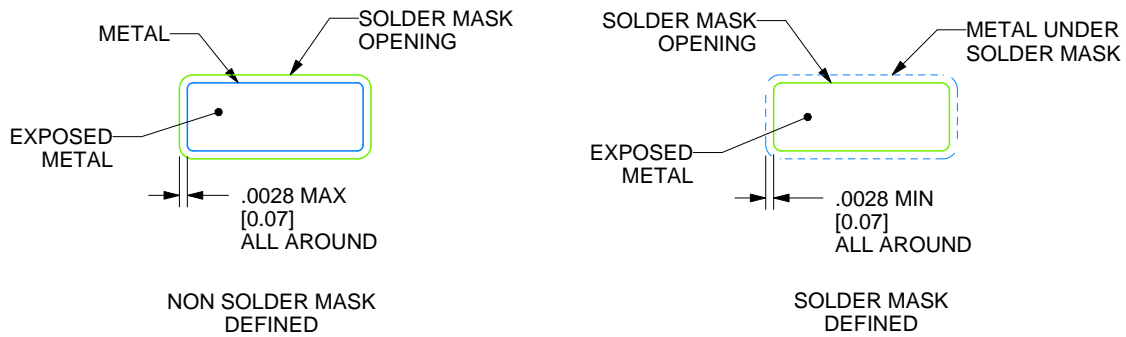

SOLDER MASK DETAILS

4214825/C 02/2019

NOTES: (continued)

6. Publication IPC-7351 may have alternate designs.
7. Solder mask tolerances between and around signal pads can vary based on board fabrication site.

EXAMPLE STENCIL DESIGN**D0008A****SOIC - 1.75 mm max height**

SMALL OUTLINE INTEGRATED CIRCUIT

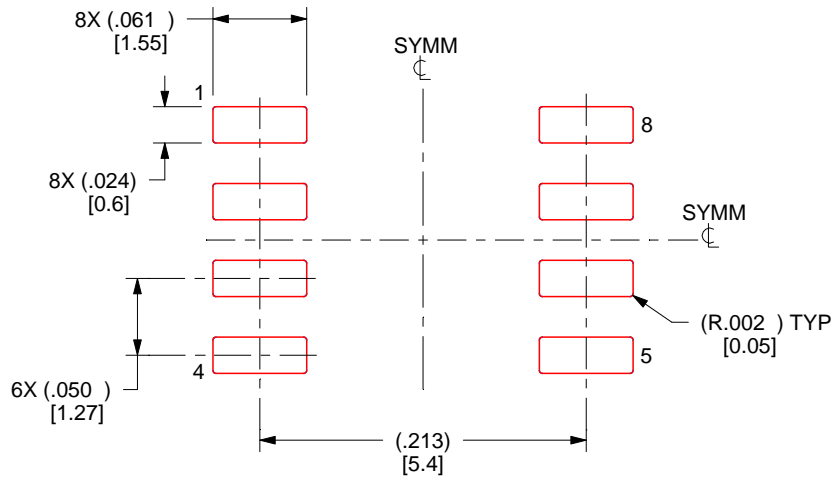

SOLDER PASTE EXAMPLE
 BASED ON .005 INCH [0.125 MM] THICK STENCIL
 SCALE:8X

4214825/C 02/2019

NOTES: (continued)

8. Laser cutting apertures with trapezoidal walls and rounded corners may offer better paste release. IPC-7525 may have alternate design recommendations.
9. Board assembly site may have different recommendations for stencil design.

MECHANICAL DATA

PS (R-PDSO-G8)

PLASTIC SMALL-OUTLINE PACKAGE

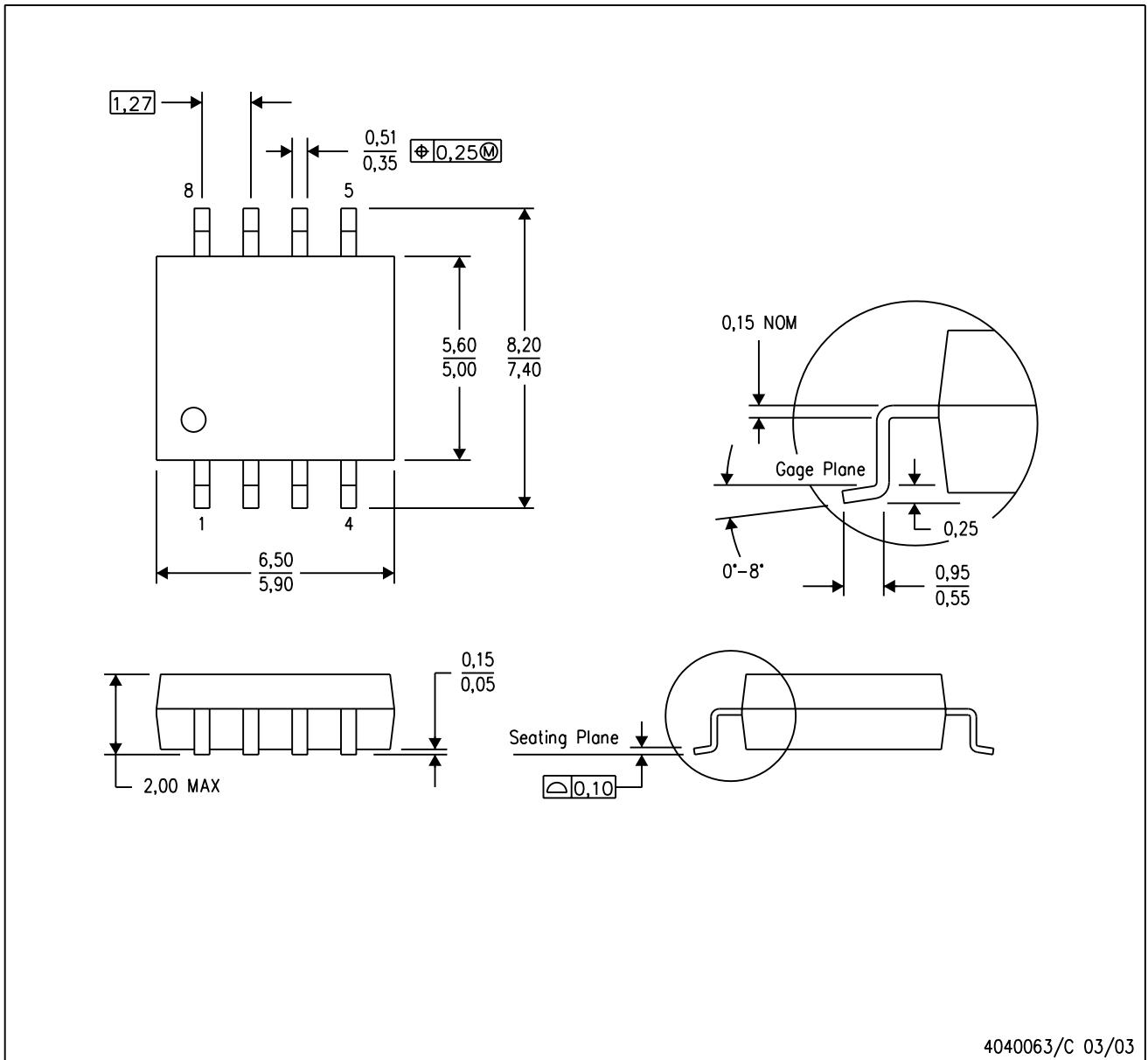

- NOTES:
- All linear dimensions are in millimeters.
 - This drawing is subject to change without notice.
 - Body dimensions do not include mold flash or protrusion, not to exceed 0,15.

PS (R-PDSO-G8)

PLASTIC SMALL OUTLINE

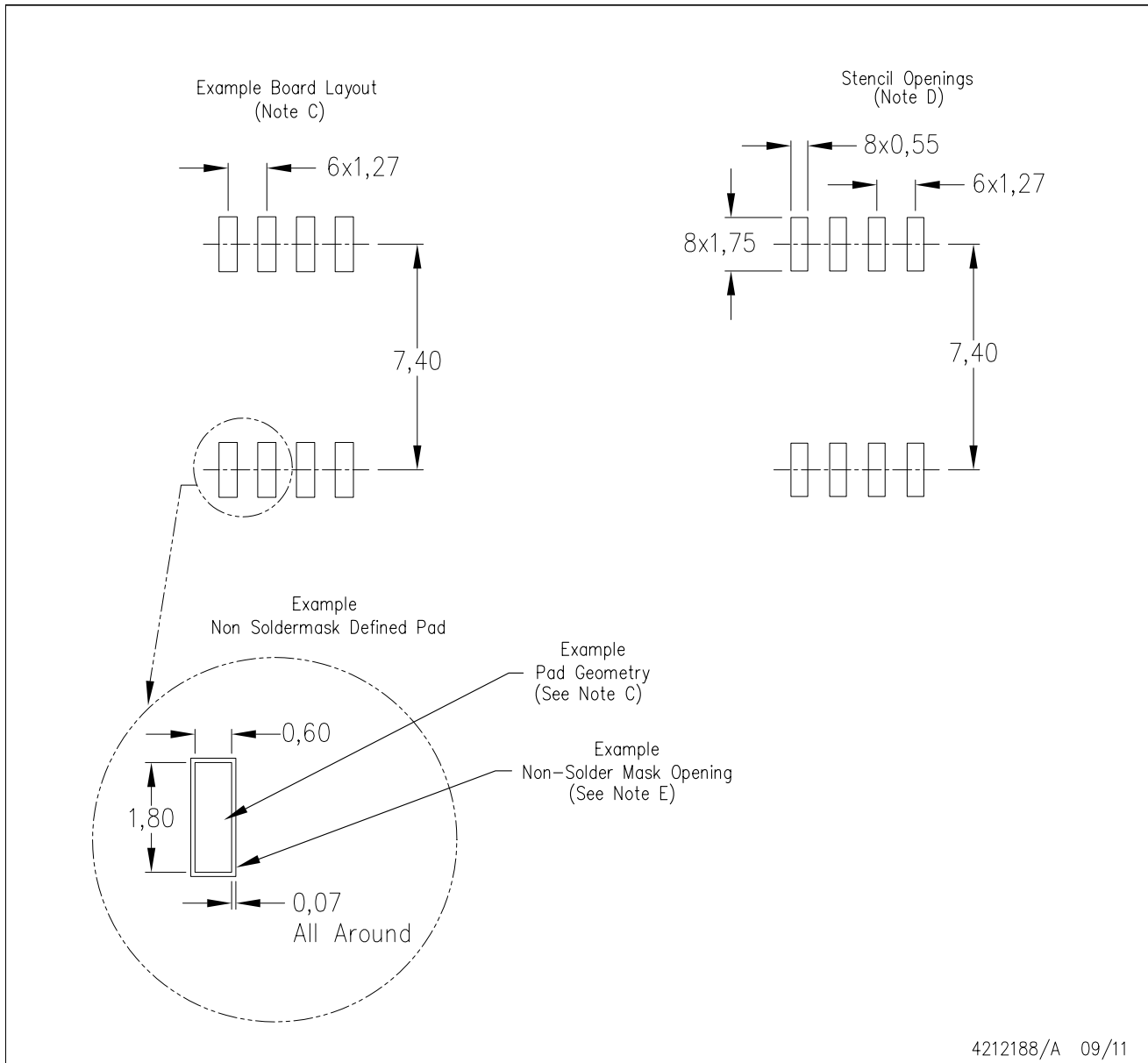

- NOTES:
- All linear dimensions are in millimeters.
 - This drawing is subject to change without notice.
 - Publication IPC-7351 is recommended for alternate designs.
 - Laser cutting apertures with trapezoidal walls and also rounding corners will offer better paste release. Customers should contact their board assembly site for stencil design recommendations. Refer to IPC-7525 for other stencil recommendations.
 - Customers should contact their board fabrication site for solder mask tolerances between and around signal pads.

MECHANICAL DATA

P (R-PDIP-T8)

PLASTIC DUAL-IN-LINE PACKAGE

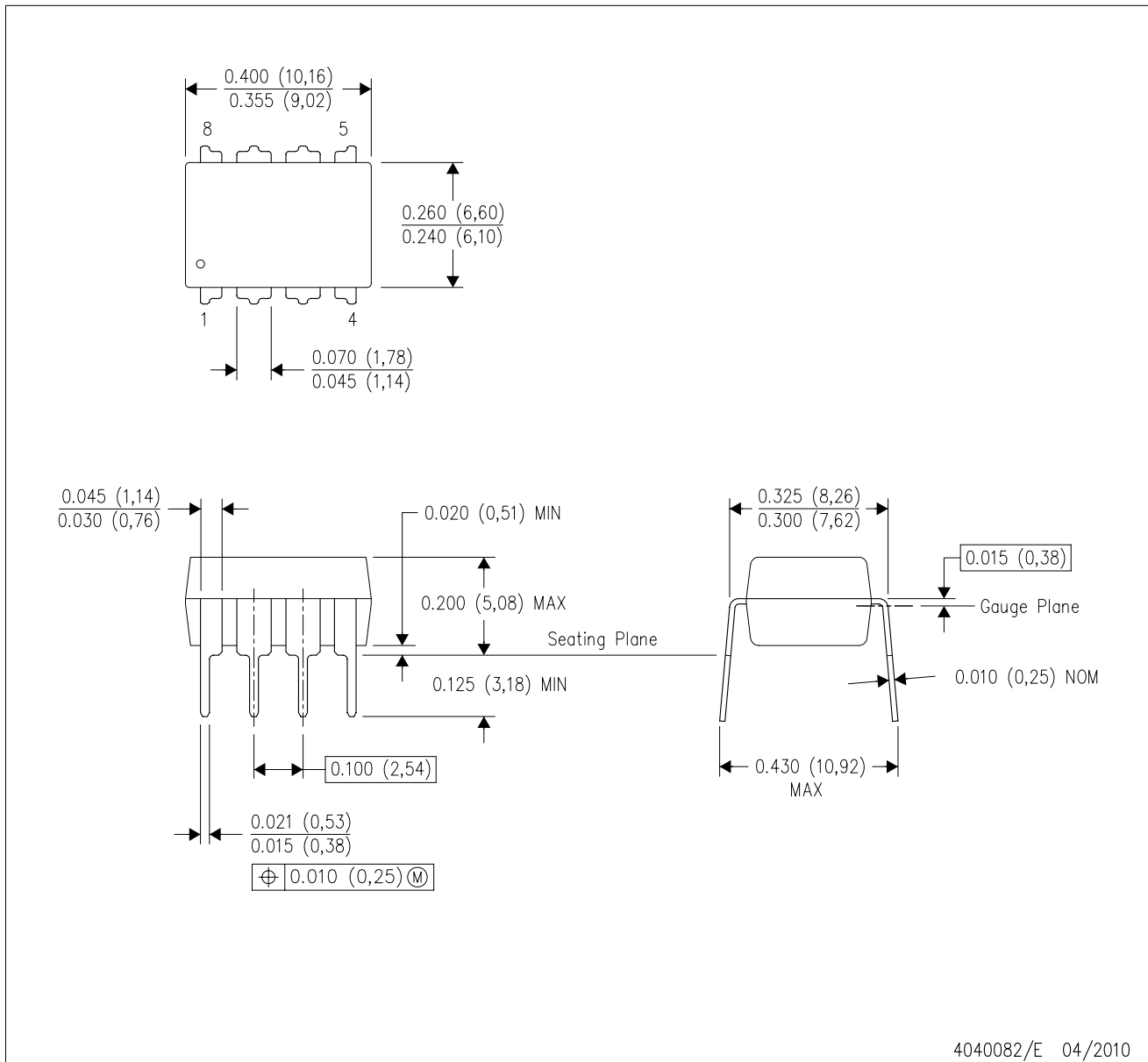

- NOTES:
- All linear dimensions are in inches (millimeters).
 - This drawing is subject to change without notice.
 - Falls within JEDEC MS-001 variation BA.

GENERIC PACKAGE VIEW

DSG 8

WSON - 0.8 mm max height

2 x 2, 0.5 mm pitch

PLASTIC SMALL OUTLINE - NO LEAD

This image is a representation of the package family, actual package may vary.
Refer to the product data sheet for package details.

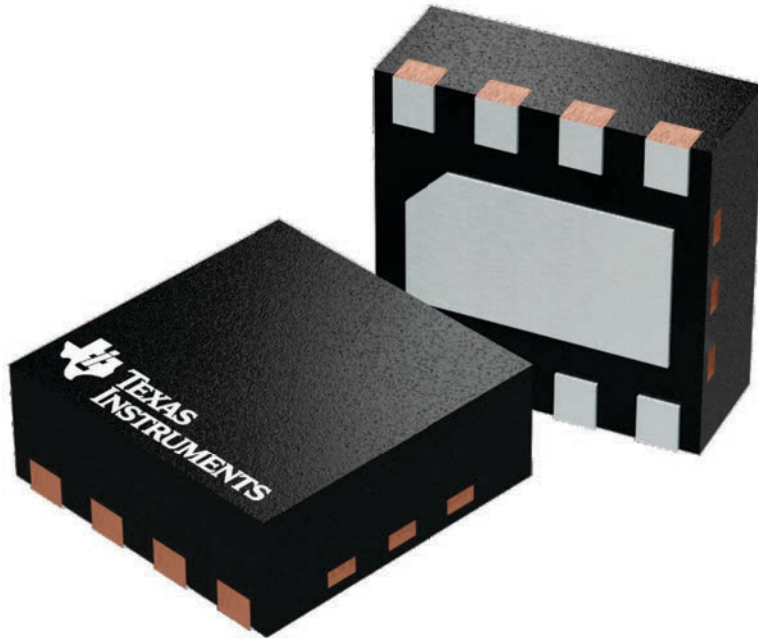

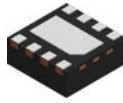

DSG0008A

PACKAGE OUTLINE

WSON - 0.8 mm max height

PLASTIC SMALL OUTLINE - NO LEAD

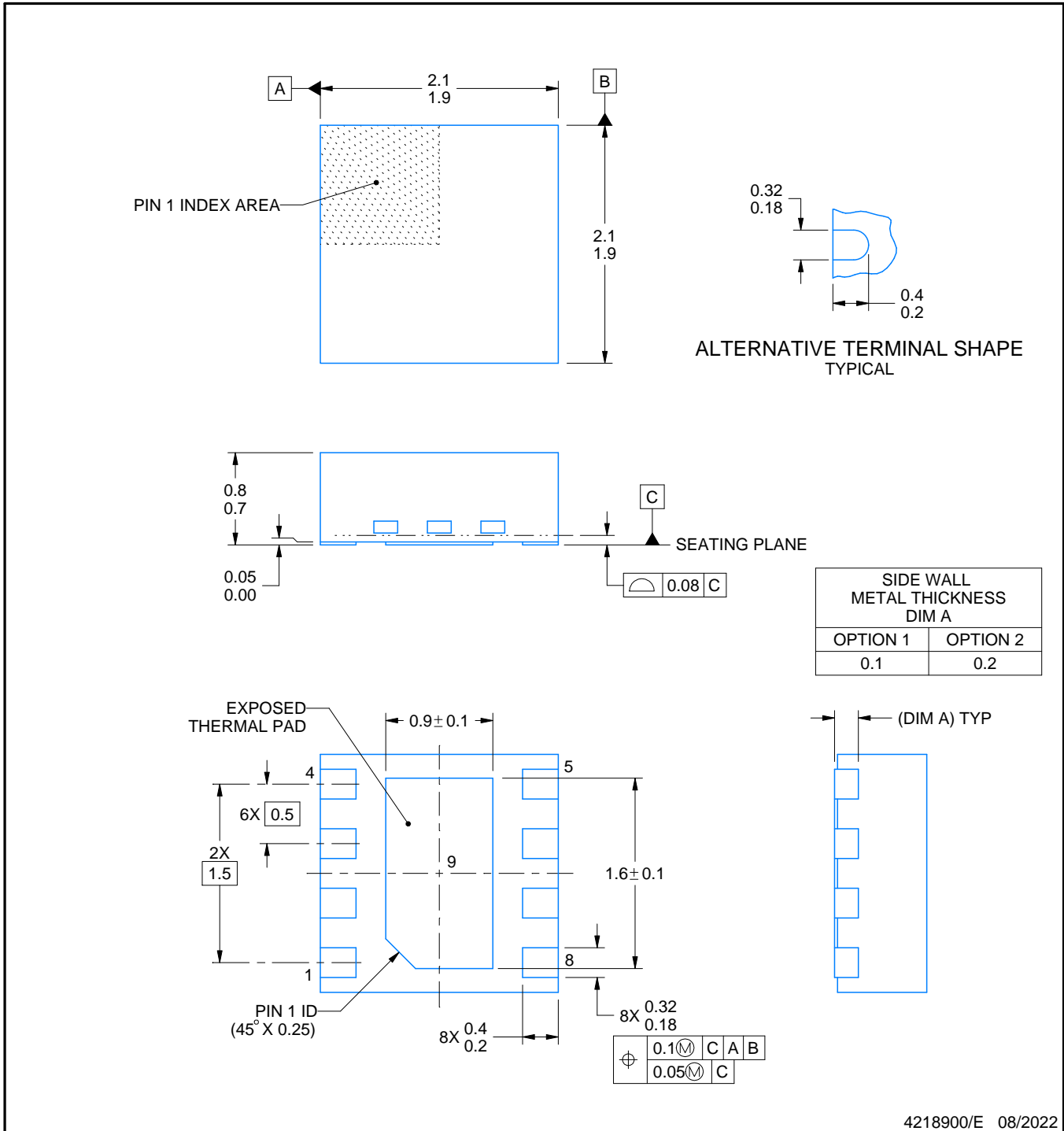

NOTES:

1. All linear dimensions are in millimeters. Any dimensions in parenthesis are for reference only. Dimensioning and tolerancing per ASME Y14.5M.
2. This drawing is subject to change without notice.
3. The package thermal pad must be soldered to the printed circuit board for thermal and mechanical performance.

EXAMPLE BOARD LAYOUT

DSG0008A

WSON - 0.8 mm max height

PLASTIC SMALL OUTLINE - NO LEAD

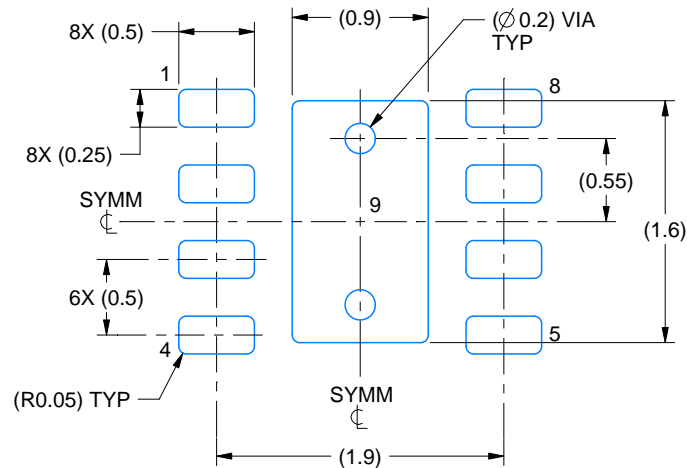

LAND PATTERN EXAMPLE
SCALE:20X

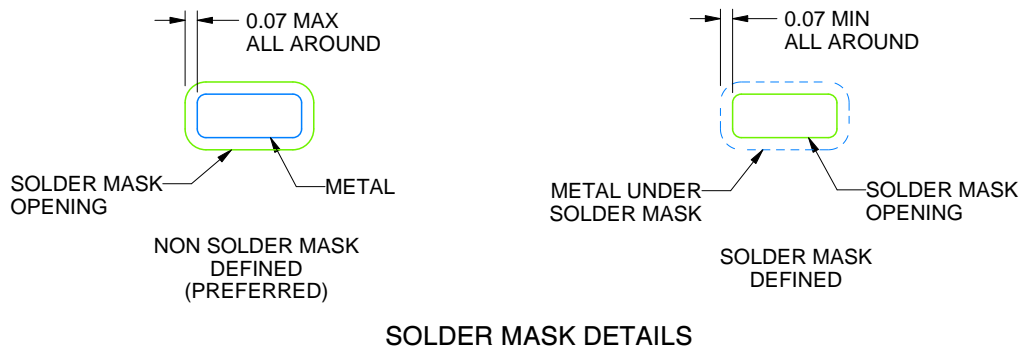

SOLDER MASK DETAILS

4218900/E 08/2022

NOTES: (continued)

4. This package is designed to be soldered to a thermal pad on the board. For more information, see Texas Instruments literature number SLUA271 (www.ti.com/lit/slua271).
5. Vias are optional depending on application, refer to device data sheet. If any vias are implemented, refer to their locations shown on this view. It is recommended that vias under paste be filled, plugged or tented.

EXAMPLE STENCIL DESIGN**DSG0008A****WSON - 0.8 mm max height**

PLASTIC SMALL OUTLINE - NO LEAD

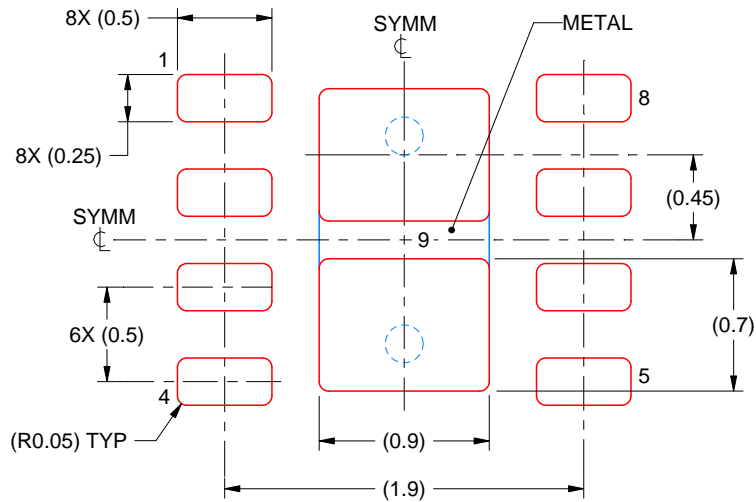

SOLDER PASTE EXAMPLE
 BASED ON 0.125 mm THICK STENCIL

EXPOSED PAD 9:
 87% PRINTED SOLDER COVERAGE BY AREA UNDER PACKAGE
 SCALE:25X

4218900/E 08/2022

NOTES: (continued)

6. Laser cutting apertures with trapezoidal walls and rounded corners may offer better paste release. IPC-7525 may have alternate design recommendations.



PACKAGE OUTLINE

PW0008A

TSSOP - 1.2 mm max height

SMALL OUTLINE PACKAGE

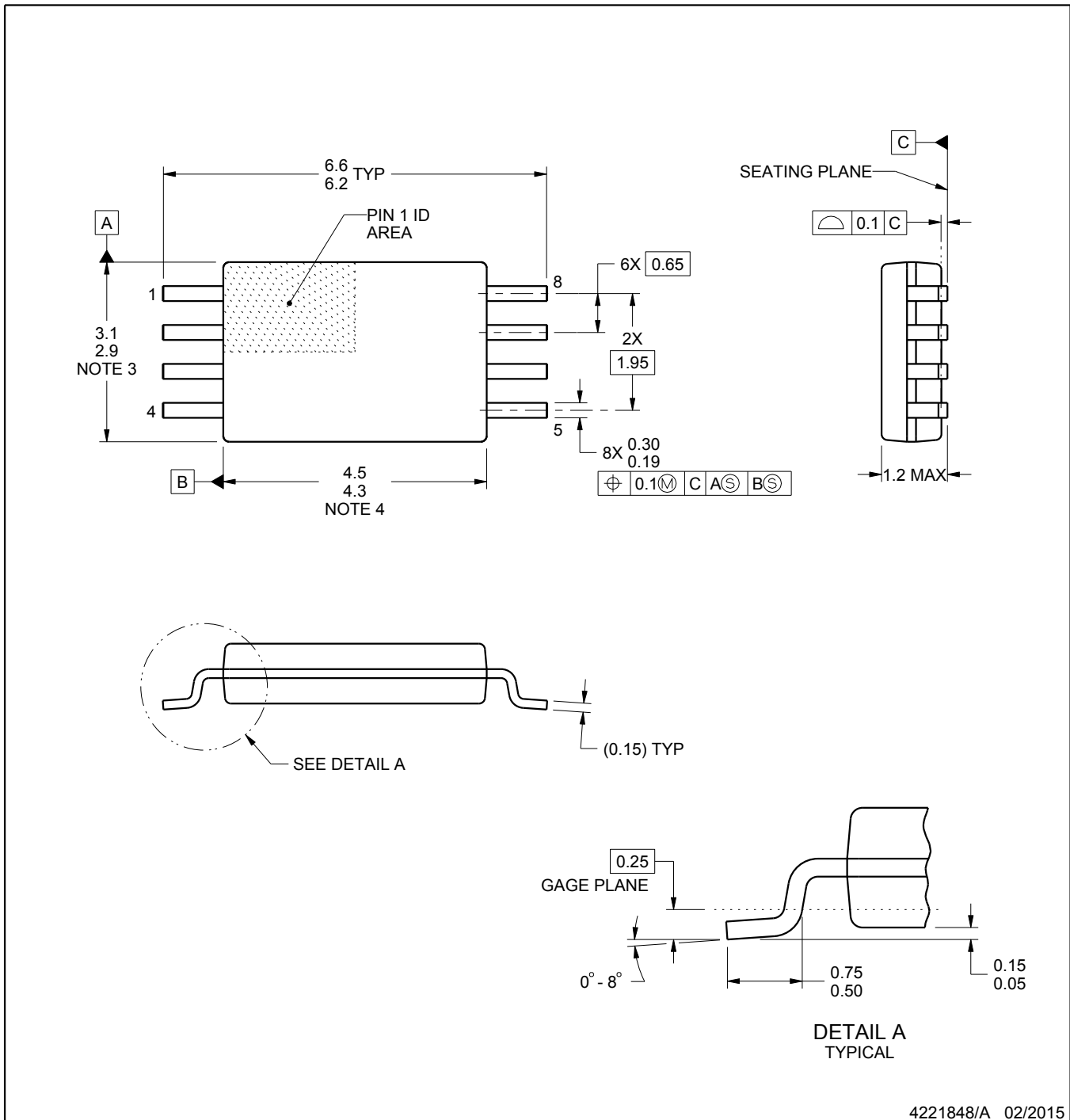

NOTES:

1. All linear dimensions are in millimeters. Any dimensions in parenthesis are for reference only. Dimensioning and tolerancing per ASME Y14.5M.
2. This drawing is subject to change without notice.
3. This dimension does not include mold flash, protrusions, or gate burrs. Mold flash, protrusions, or gate burrs shall not exceed 0.15 mm per side.
4. This dimension does not include interlead flash. Interlead flash shall not exceed 0.25 mm per side.
5. Reference JEDEC registration MO-153, variation AA.

EXAMPLE BOARD LAYOUT

PW0008A

TSSOP - 1.2 mm max height

SMALL OUTLINE PACKAGE

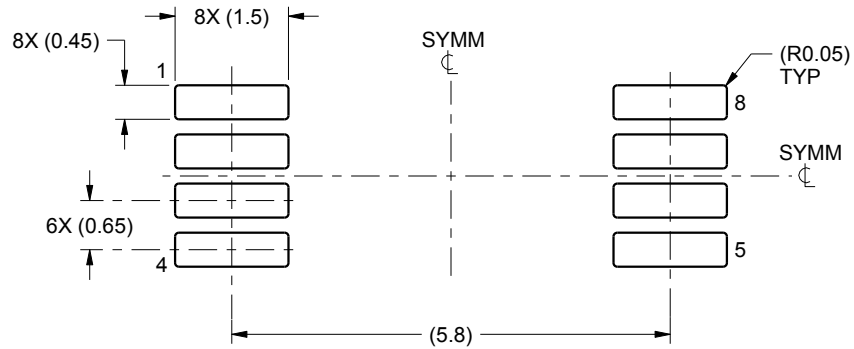

LAND PATTERN EXAMPLE
SCALE:10X

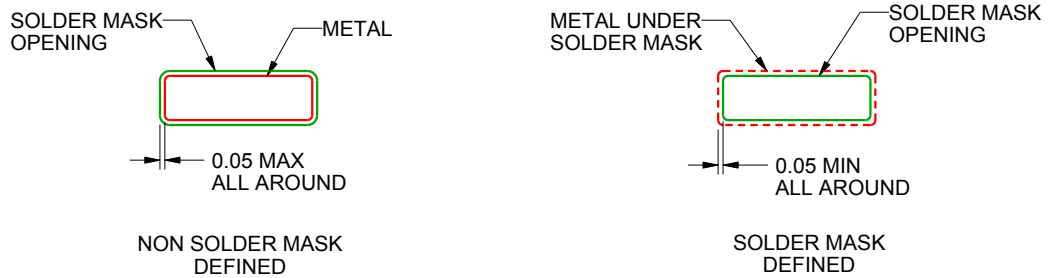

SOLDER MASK DETAILS
NOT TO SCALE

4221848/A 02/2015

NOTES: (continued)

- 6. Publication IPC-7351 may have alternate designs.
- 7. Solder mask tolerances between and around signal pads can vary based on board fabrication site.

EXAMPLE STENCIL DESIGN**PW0008A****TSSOP - 1.2 mm max height**

SMALL OUTLINE PACKAGE

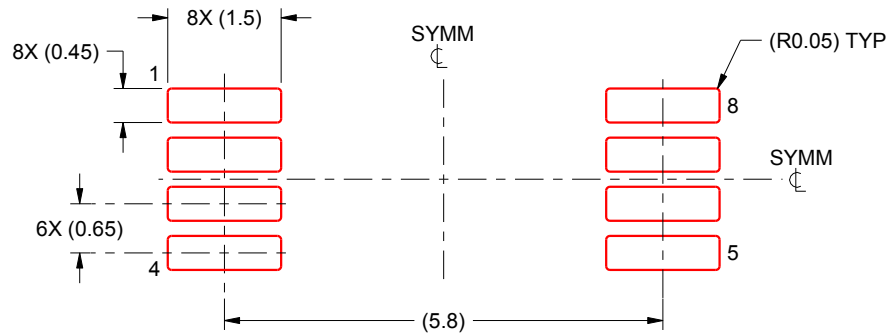

SOLDER PASTE EXAMPLE
 BASED ON 0.125 mm THICK STENCIL
 SCALE:10X

4221848/A 02/2015

NOTES: (continued)

8. Laser cutting apertures with trapezoidal walls and rounded corners may offer better paste release. IPC-7525 may have alternate design recommendations.
9. Board assembly site may have different recommendations for stencil design.



DGK0008A

PACKAGE OUTLINE

VSSOP - 1.1 mm max height

SMALL OUTLINE PACKAGE

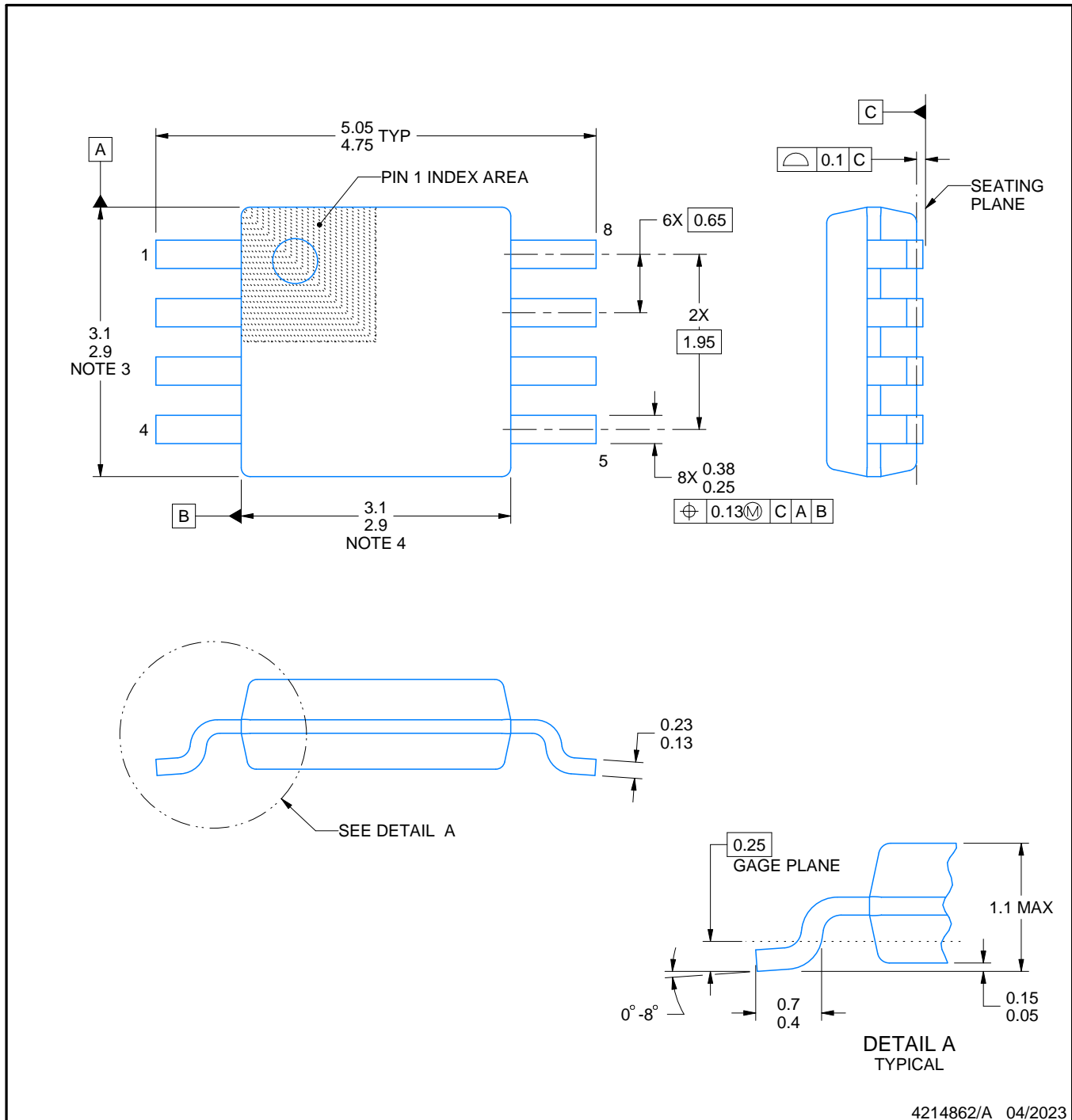

NOTES:

PowerPAD is a trademark of Texas Instruments.

- All linear dimensions are in millimeters. Any dimensions in parenthesis are for reference only. Dimensioning and tolerancing per ASME Y14.5M.
- This drawing is subject to change without notice.
- This dimension does not include mold flash, protrusions, or gate burrs. Mold flash, protrusions, or gate burrs shall not exceed 0.15 mm per side.
- This dimension does not include interlead flash. Interlead flash shall not exceed 0.25 mm per side.
- Reference JEDEC registration MO-187.

EXAMPLE BOARD LAYOUT**DGK0008A****™ VSSOP - 1.1 mm max height**

SMALL OUTLINE PACKAGE

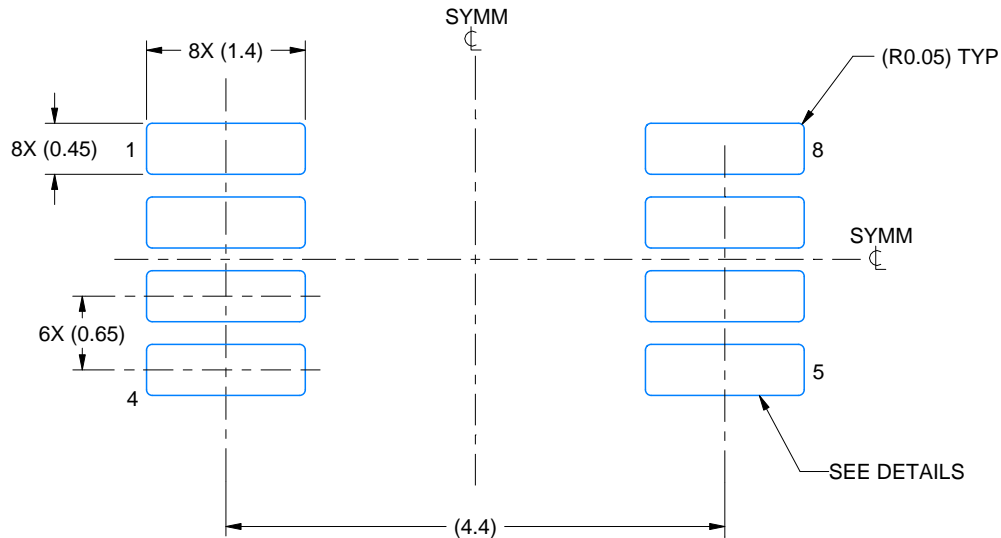

LAND PATTERN EXAMPLE
EXPOSED METAL SHOWN
SCALE: 15X

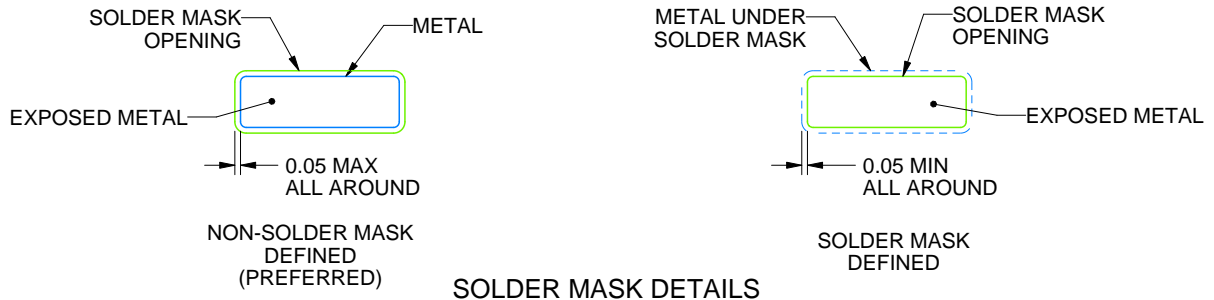

SOLDER MASK DETAILS

4214862/A 04/2023

NOTES: (continued)

6. Publication IPC-7351 may have alternate designs.
7. Solder mask tolerances between and around signal pads can vary based on board fabrication site.
8. Vias are optional depending on application, refer to device data sheet. If any vias are implemented, refer to their locations shown on this view. It is recommended that vias under paste be filled, plugged or tented.
9. Size of metal pad may vary due to creepage requirement.

EXAMPLE STENCIL DESIGN**DGK0008A****™ VSSOP - 1.1 mm max height**

SMALL OUTLINE PACKAGE

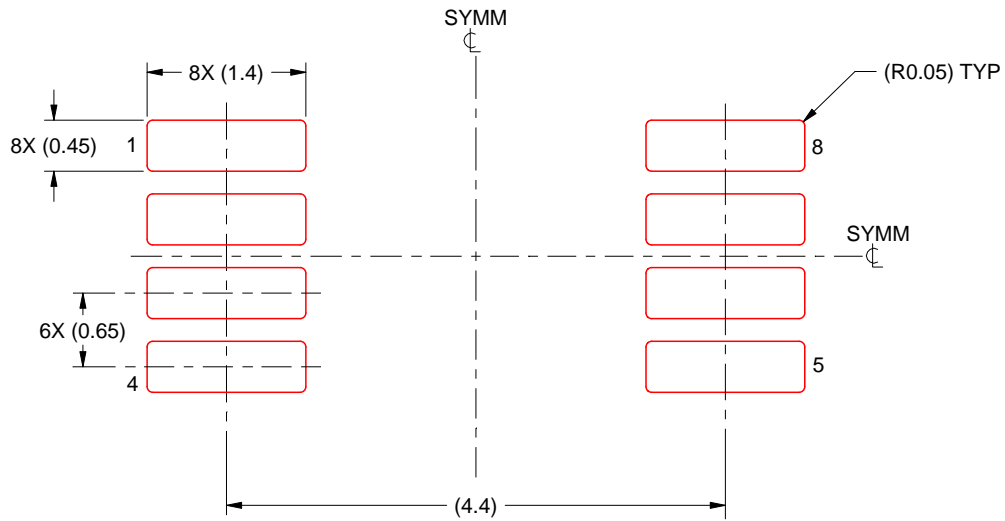

SOLDER PASTE EXAMPLE
SCALE: 15X

4214862/A 04/2023

NOTES: (continued)

11. Laser cutting apertures with trapezoidal walls and rounded corners may offer better paste release. IPC-7525 may have alternate design recommendations.
12. Board assembly site may have different recommendations for stencil design.

IMPORTANT NOTICE AND DISCLAIMER

TI PROVIDES TECHNICAL AND RELIABILITY DATA (INCLUDING DATA SHEETS), DESIGN RESOURCES (INCLUDING REFERENCE DESIGNS), APPLICATION OR OTHER DESIGN ADVICE, WEB TOOLS, SAFETY INFORMATION, AND OTHER RESOURCES "AS IS" AND WITH ALL FAULTS, AND DISCLAIMS ALL WARRANTIES, EXPRESS AND IMPLIED, INCLUDING WITHOUT LIMITATION ANY IMPLIED WARRANTIES OF MERCHANTABILITY, FITNESS FOR A PARTICULAR PURPOSE OR NON-INFRINGEMENT OF THIRD PARTY INTELLECTUAL PROPERTY RIGHTS.

These resources are intended for skilled developers designing with TI products. You are solely responsible for (1) selecting the appropriate TI products for your application, (2) designing, validating and testing your application, and (3) ensuring your application meets applicable standards, and any other safety, security, regulatory or other requirements.

These resources are subject to change without notice. TI grants you permission to use these resources only for development of an application that uses the TI products described in the resource. Other reproduction and display of these resources is prohibited. No license is granted to any other TI intellectual property right or to any third party intellectual property right. TI disclaims responsibility for, and you will fully indemnify TI and its representatives against, any claims, damages, costs, losses, and liabilities arising out of your use of these resources.

TI's products are provided subject to [TI's Terms of Sale](#) or other applicable terms available either on [ti.com](https://www.ti.com) or provided in conjunction with such TI products. TI's provision of these resources does not expand or otherwise alter TI's applicable warranties or warranty disclaimers for TI products.

TI objects to and rejects any additional or different terms you may have proposed.

Mailing Address: Texas Instruments, Post Office Box 655303, Dallas, Texas 75265

Copyright © 2025, Texas Instruments Incorporated

OUR CERTIFICATE

DiGi provide top-quality products and perfect service for customer worldwide through standardization, technological innovation and continuous improvement. DiGi through third-party certification, we stricly control the quality of products and services. Welcome your RFQ to

Email: Info@DiGi-Electronics.com



Tel: +00 852-30501935

RFQ Email: Info@DiGi-Electronics.com

DiGi is a global authorized distributor of electronic components.