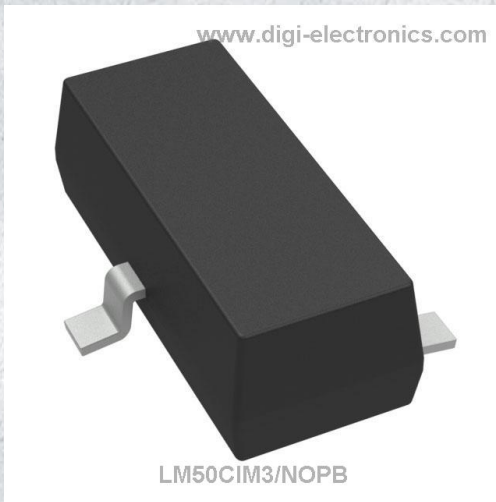


# LM50CIM3/NOPB Datasheet



<https://www.DiGi-Electronics.com>

DiGi Electronics Part Number	LM50CIM3/NOPB-DG
Manufacturer	<a href="#">Texas Instruments</a>
Manufacturer Product Number	LM50CIM3/NOPB
Description	SENSOR ANALOG -40C-125C SOT23-3
Detailed Description	Temperature Sensor Analog, Local -40°C ~ 125°C 10 mV/°C SOT-23-3



Tel: +00 852-30501935

RFQ Email: [Info@DiGi-Electronics.com](mailto:Info@DiGi-Electronics.com)

DiGi is a global authorized distributor of electronic components.

## Purchase and inquiry

Manufacturer Product Number:

LM50CIM3/NOPB

Series:

-

Sensor Type:

Analog, Local

Sensing Temperature - Remote:

-

Voltage - Supply:

4.5V ~ 10V

Features:

-

Test Condition:

25°C (-40°C ~ 125°C)

Mounting Type:

Surface Mount

Supplier Device Package:

SOT-23-3

Manufacturer:

Texas Instruments

Product Status:

Obsolete

Sensing Temperature - Local:

-40°C ~ 125°C

Output Type:

Analog Voltage

Resolution:

10mV/°C

Accuracy - Highest (Lowest):

±3°C (±4°C)

Operating Temperature:

-40°C ~ 150°C

Package / Case:

TO-236-3, SC-59, SOT-23-3

Base Product Number:

LM50

## Environmental & Export classification

RoHS Status:

ROHS3 Compliant

REACH Status:

REACH Unaffected

HTSUS:

8542.39.0001

Moisture Sensitivity Level (MSL):

1 (Unlimited)

ECCN:

EAR99

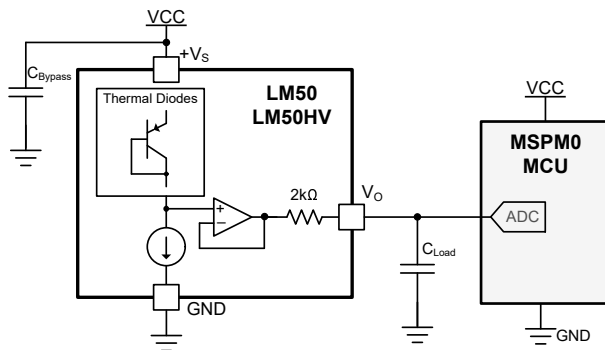
# LM50 and LM50HV Industry-Standard, Analog Centigrade (10mV/°C) Temperature Sensor in the SOT-23 Package

## 1 Features

- Industry-Standard Sensor Gain/Offset:
  - 10mV/°C, 500mV at 0°C
- LM50HV (Next-generation):
  - Drop-in replacement for LM50B/LM50C
  - Wide supply range: 3V to 36V
  - Temperature Accuracy:
    - ±2°C (Max) over 20°C to 70°C
    - ±2.5°C (Max) over -10°C to 125°C
    - ±3°C (Max) over -20°C to 150°C
  - Quiescent Current (Typ): 52µA
  - Nonlinearity: ±1.2°C (Max)
- LM50:
  - Operating supply range: 4.5V to 10V
  - LM50B Temperature Accuracy:
    - ±2°C (Max) at 25°C
    - ±3°C (Max) over temperature range
  - LM50C Temperature Accuracy:
    - ±3°C (Max) at 25°C
    - ±4°C (Max) over temperature range
  - Quiescent Current (Typ): 95µA
  - Nonlinearity: ±0.8°C (Max)
- Available in Standard SOT23-3 package
- DC Output Impedance: 2kΩ/4kΩ (Typ/Max)
  - Enables driving large capacitive loads
- Designed for LDO-less applications
- [UL Recognized Component \(LM50B, LM50C\)](#)

## 2 Applications

- [Mobile phones, PC & notebooks, Data storage](#)
- [Battery Management](#)
- [Home and Multifunction printers](#)
- [Medical and healthcare Instruments](#)
- [HVAC System](#)
- [Power Supply Modules](#)



Simplified Schematic

## 3 Description

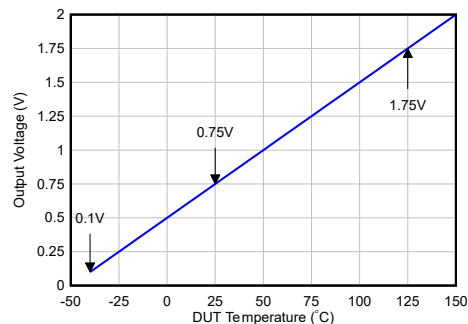
The LM50 and LM50HV devices are precision analog temperature sensors that can measure temperatures from -40°C to 125°C (for LM50) and -40°C to 150°C (for LM50HV) using a single positive supply. Unlike NTC thermistors, LM50 and LM50HV do not require any external calibration, trimming or software linearization leading to simplifying the circuitry requirements. The output voltage of the devices are linearly proportional to temperature (10mV/°C) and has a DC offset of 500mV at 0°C. The offset allows reading negative temperatures without the need for a negative supply. The output voltage of the LM50 and LM50HV ranges from 100mV (at -40°C) to 1.75V (at 125°C for LM50) and 2V (at 150°C for LM50HV), simplifying analog-to-digital converter (ADC) interfacing.

LM50HV is designed for LDO-less application due to stable functionality across wide supply range of 3V to 36V. Trimming and calibration of the LM50 and LM50HV at the wafer level provide long-term availability, low cost and consistent accuracy: LM50B (±3°C over temperature range), LM50C (±4°C over temperature range) and LM50HV (±3°C over -20°C to 150°C).

### Package Information

PART NUMBER	PACKAGE <sup>(1)</sup>	PACKAGE SIZE <sup>(2)</sup>
LM50 and LM50HV	DBZ (SOT-23, 3)	2.37mm × 2.92mm

- For more information, see [Section 11](#).
- The package size (length × width) is a nominal value and includes pins, where applicable.



Full-Range Temperature Sensor LM50 (-40°C to 125°C) and LM50HV (-40°C to 150°C)



## Table of Contents

<b>1 Features</b> .....	<b>1</b>	7.3 Feature Description.....	<b>15</b>
<b>2 Applications</b> .....	<b>1</b>	7.4 Device Functional Modes.....	<b>15</b>
<b>3 Description</b> .....	<b>1</b>	<b>8 Application and Implementation</b> .....	<b>16</b>
<b>4 Device Comparison</b> .....	<b>3</b>	8.1 Application Information.....	<b>16</b>
<b>5 Pin Configuration and Functions</b> .....	<b>4</b>	8.2 Typical Application.....	<b>16</b>
<b>6 Specifications</b> .....	<b>5</b>	8.3 System Examples.....	<b>19</b>
6.1 Absolute Maximum Ratings.....	<b>5</b>	8.4 Power Supply Recommendations.....	<b>21</b>
6.2 ESD Ratings.....	<b>5</b>	8.5 Layout.....	<b>21</b>
6.3 Recommended Operating Conditions.....	<b>5</b>	<b>9 Device and Documentation Support</b> .....	<b>24</b>
6.4 Thermal Information.....	<b>5</b>	9.1 Documentation Support.....	<b>24</b>
6.5 Electrical Characteristics: LM50 (LM50B and LM50C).....	<b>6</b>	9.2 Receiving Notification of Documentation Updates....	<b>24</b>
6.6 Electrical Characteristics: LM50HV.....	<b>7</b>	9.3 Support Resources.....	<b>24</b>
6.7 Typical Characteristics (LM50B and LM50C).....	<b>8</b>	9.4 Trademarks.....	<b>24</b>
6.8 Typical Characteristics (LM50HV).....	<b>12</b>	9.5 Electrostatic Discharge Caution.....	<b>24</b>
<b>7 Detailed Description</b> .....	<b>15</b>	9.6 Glossary.....	<b>24</b>
7.1 Overview.....	<b>15</b>	<b>10 Revision History</b> .....	<b>24</b>
7.2 Functional Block Diagram.....	<b>15</b>	<b>11 Mechanical, Packaging, and Orderable Information</b> .....	<b>25</b>

## 4 Device Comparison

**Table 4-1. Device Comparison**

Feature	LM50HV	LM50B <sup>(1)</sup>	LM50C <sup>(1)</sup> LMT90 <sup>(1)</sup>	TMP235	LM60 <sup>(1)</sup>	LM61B <sup>(1)</sup>	LM20B <sup>(1)</sup>	LM35 <sup>(1)</sup>
Sensor gain (mV/°C)	10	10	10	10	6.25	10	-11.77	10
Sensor gain type	Fixed	Fixed	Fixed	Fixed	Fixed	Fixed	Fixed	Fixed
Offset at 0°C (mV)	500	500	500	500	424	600	1864	0
Temp Range (°C)	-40 to 150	-40 to 125	-40 to 125	-40 to 150	-40 to 125	-25 to 85	-55 to 130	-55 to 150
<b>Power Supply Specifications</b>								
V <sub>DD</sub> (V)	3 to 36	4.5 to 10	4.5 to 10	2.3 to 5.5	2.7 to 10	2.7 to 10	2.4 to 5.5	4 to 30
I <sub>Q</sub> (typ) (µA)	52	95	95	9	82	82	4.5	67
<b>Temperature Accuracy</b>								
25°C (typ)	±1	-	-	±0.5	-	-	-	±0.2
-55°C (max)	-	-	-	-	-	-	±2.5	±1
-40°C (max)	±3.5	-3.5/3	±4	±2	±3	-	±2.3	±0.9
-30°C (max)	±3.5	-3.3/2.85	±3.85	±2	±2.85	-	±2.2	±0.85
-25°C (max)	±3.5	-3.2/2.8	±3.8	±2	±2.8	±3	±2.1	±0.8
-20°C (max)	±3	-3/2.7	±3.7	±2	±2.7	±2.9	±2.05	±0.8
-10°C (max)	±2.5	-2.8/2.5	±3.5	±2	±2.5	±2.7	±1.95	±0.7
0°C (max)	±2.5	-2.6/2.4	±3.4	±1	±2.4	±2.5	±1.9	±0.65
20°C (max)	±2	±2.1	±3.1	±1	±2.1	±2.1	±1.55	±0.5
25°C (max)	±2	±2	±3	±1	±2	±2	±1.5	±0.5
30°C (max)	±2	±2.05	±3.05	±1	±2.05	±2.1	±1.5	±0.5
70°C (max)	±2	±2.45	±3.45	±1	±2.45	±2.75	±1.9	±0.7
80°C (max)	±2.5	±2.55	±3.55	±2	±2.55	±2.9	±2	±0.7
85°C (max)	±2.5	±2.6	±3.6	±2	±2.6	±3	±2.1	±0.75
100°C (max)	±2.5	±2.75	±3.75	±2	±2.75	-	±2.2	±0.8
125°C (max)	±2.5	±3	±4	±2	±3	-	±2.5	±0.9
130°C (max)	±3	-	-	±2	-	-	±2.5	±0.9
150°C (max)	±3	-	-	±2	-	-	-	±1
<b>Packaging Dimension</b>								
Dimensions [mm × mm × mm]	<b>SOT23</b> (3-pin) 2.4 × 2.9 × 1.1			<b>SOT23</b> (3-pin) 2.4 × 2.9 × 1.1  <b>SC70</b> (5-pin) 2.1 × 2.0 × 1.1	<b>SOT23</b> (3-pin) 2.4 × 2.9 × 1.1  <b>TO92</b> (3-pin) 4.8 × 7.4 × 3.7	<b>SC70</b> (5-pin) 2.1 × 2.0 × 1.1  <b>DSBGA</b> (4-pin) 0.96 × 0.96 × 0.6	<b>SOIC</b> (8-pin) 6.0 × 4.9 × 1.75  <b>TO92</b> (3-pin) 4.8 × 7.4 × 3.7  <b>TOCAN</b> (3-pin) 4.7 × 4.7 × 2.67  <b>TO220</b> (3-pin) 10 × 15 × 4.6	

- LM50B, LM50C, LMT90, LM60, LM61B, LM20B and LM35 temperature accuracy limits come from the "Accuracy vs Temperature" plot.

**LM50, LM50HV**

SNIS1181 – JULY 1999 – REVISED OCTOBER 2025

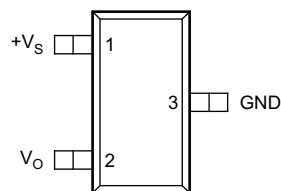
**Table 4-2. LM50 and LM50HV Devices Orderable Options**

DEVICE NAME	PART NUMBER	ACCURACY OVER TEMPERATURE	SPECIFIED TEMPERATURE RANGE	SUPPLY RANGE	PACKAGE
LM50	LM50BIM3	-3.5°C/3°C	-25°C ≤ T <sub>A</sub> ≤ +100°C	4.5V to 10V	SOT-23 (DBZ) 3-pin
	LM50BIM3X/NOPB <sup>1</sup>		-25°C ≤ T <sub>A</sub> ≤ +100°C (Legacy chip)		
			-40°C ≤ T <sub>A</sub> ≤ +125°C (New chip)		
	LM50CIM3	±4°C	-40°C ≤ T <sub>A</sub> ≤ +125°C		
	LM50CIM3X				
LM50CIM3X/NOPB	-40°C ≤ T <sub>A</sub> ≤ +125°C (Both legacy & new chip)				
LM50HV	LM50HVDBZR	±2°C	20°C ≤ T <sub>A</sub> ≤ +70°C	3V to 36V	
		±2.5°C	-10°C ≤ T <sub>A</sub> ≤ +125°C		
		±3.5°C	-40°C ≤ T <sub>A</sub> ≤ +125°C		
		±3°C	-20°C ≤ T <sub>A</sub> ≤ +150°C		
		±3.5°C	-40°C ≤ T <sub>A</sub> ≤ +150°C		

1. LM50BIM3X/NOPB (Legacy chip) operates from -25°C to 100°C while LM50BIM3X/NOPB (New chip) operates from -40°C to 125°C.

**Table 4-3. LM50 and LM50HV Devices Nomenclature Detail**

PRODUCT	DESCRIPTION
LM50xlyyy	x indicates that the device has <b>B</b> or <b>C</b> variant. These devices can ship with the legacy chip (CSO: GF6 or SHE) or the new chip (CSO: RFB) with different <i>chip source origin</i> (CSO). The reel packaging label provides date code information to distinguish which chip is being used. Device performance for new and legacy chips is denoted throughout the document. yyy indicates the package type of the device which can be <b>M3</b> , <b>M3X</b> and <b>M3X/NOPB</b> all in DBZ (SOT-23 3-pin).
LM50HVyyyR	LM50HV has only CSO: RFB. yyy indicates that the package type of the device is <b>DBZ</b> (SOT-23 3-pin).

**5 Pin Configuration and Functions****Figure 5-1. DBZ Package 3-Pin SOT-23 Top View****Table 5-1. Pin Functions**

PIN		TYPE	DESCRIPTION
NO.	NAME		
1	+V <sub>S</sub>	Power	Positive power supply pin.
2	V <sub>O</sub>	Output	Temperature sensor analog output.
3	GND	Ground	Device ground pin, connected to power supply negative terminal.

## 6 Specifications

### 6.1 Absolute Maximum Ratings

Over operating free-air temperature range unless otherwise noted<sup>(1)</sup>

		MIN	MAX	UNIT
Supply voltage, +V <sub>S</sub>	LM50 (LM50B and LM50C)	-0.2	12	V
	LM50HV	-0.2	39.6	
Output voltage, V <sub>O</sub>	LM50 (LM50B and LM50C)	-1	+V <sub>S</sub> + 0.6 <sup>(2)</sup>	V
	LM50HV	-0.3	+V <sub>S</sub> + 0.3 <sup>(2)</sup>	
Output current, I <sub>OUT</sub>			10	mA
Maximum junction temperature, T <sub>J</sub>			150	°C
Storage temperature, T <sub>stg</sub>	LM50 (LM50B and LM50C)	-65	150	°C
	LM50HV	-65	175	

- (1) Operation outside the *Absolute Maximum Ratings* may cause permanent device damage. *Absolute Maximum Ratings* do not imply functional operation of the device at these or any other conditions beyond those listed under *Recommended Operating Conditions*. If used outside the *Recommended Operating Conditions* but within the *Absolute Maximum Ratings*, the device may not be fully functional, and this may affect device reliability, functionality, performance, and shorten the device lifetime.
- (2) Maximum voltage must not exceed 12V for LM50 and 39.6V for LM50HV.

### 6.2 ESD Ratings

			VALUE	UNIT
V <sub>(ESD)</sub> , Electrostatic discharge	LM50 (LM50B and LM50C)	Human-body model (HBM), per JESD22-A114 <sup>(1)</sup>	±2000	V
	LM50HV		±2500	
	LM50 (LM50B and LM50C)	Charged-device model (CDM), per JEDEC specification JESD22-C101	±750	V
	LM50HV		±1000	

- (1) The human body model is a 100pF capacitor discharged through a 1.5kΩ resistor into each pin. The machine model is a 200pF capacitor discharged directly into each pin.

### 6.3 Recommended Operating Conditions

Over operating free-air temperature range (unless otherwise noted)

		MIN	MAX	UNIT		
+V <sub>S</sub>	Supply voltage	LM50 (LM50B and LM50C)	4.5	10	V	
		LM50HV	3	36		
T <sub>MIN</sub> , T <sub>MAX</sub>	Specified temperature	LM50B	Legacy chip	-25	100	°C
			New chip	-40	125	
		LM50C	-40	125		
		LM50HV	-40	150		

### 6.4 Thermal Information

THERMAL METRIC <sup>(1)</sup>		LM50		LM50HV	UNIT
		DBZ (SOT-23) Legacy chip	DBZ (SOT-23) New chip	DBZ (SOT-23)	
		3 PINS	3 PINS	3 PINS	
R <sub>θJA</sub>	Junction-to-ambient thermal resistance	291.9	240.6	240.6	°C/W
R <sub>θJC(top)</sub>	Junction-to-case (top) thermal resistance	114.3	144.5	144.5	°C/W
R <sub>θJB</sub>	Junction-to-board thermal resistance	62.3	72.3	72.3	°C/W
ψ <sub>JT</sub>	Junction-to-top characterization parameter	7.4	28.7	28.7	°C/W
ψ <sub>JB</sub>	Junction-to-board characterization parameter	61	71.7	71.7	°C/W

- (1) For more information about traditional and new thermal metrics, see the [Semiconductor and IC Package Thermal Metrics](#) application note.

**LM50, LM50HV**

SNIS1181 – JULY 1999 – REVISED OCTOBER 2025

**6.5 Electrical Characteristics: LM50 (LM50B and LM50C)**LM50:  $+V_S = 5V$  (DC) and  $I_{LOAD} = 0.5\mu A$ ,  $T_A = T_J = 25^\circ C$  (unless otherwise noted)<sup>(1)</sup>LM50B (Legacy chip only):  $T_A = T_{MIN}$  to  $T_{MAX} = -25^\circ C$  to  $100^\circ C$ LM50B (New chip) and LM50C (Both New and Legacy chip):  $T_A = T_{MIN}$  to  $T_{MAX} = -40^\circ C$  to  $125^\circ C$ 

PARAMETER		TEST CONDITIONS		MIN	TYP	MAX	UNIT
<b>SENSOR ACCURACY</b>							
$T_{ACY}$	Temperature accuracy <sup>(2)</sup>	$T_A = 25^\circ C$	LM50B (Legacy chip)	-2		2	$^\circ C$
		$T_A = T_{MAX} = 100^\circ C$		-3		3	
		$T_A = T_{MIN} = -25^\circ C$		-3.5		3	
		$T_A = 25^\circ C$	LM50B (New chip)	-2		2	$^\circ C$
		$T_A = T_{MAX} = 125^\circ C$		-3		3	
		$T_A = T_{MIN} = -40^\circ C$		-3.5		3	
		$T_A = 25^\circ C$	LM50C	-3		3	$^\circ C$
		$T_A = T_{MAX} = 125^\circ C$		-4		4	
		$T_A = T_{MIN} = -40^\circ C$		-4		4	
<b>SENSOR OUTPUT</b>							
$V_{0^\circ C}$	Output voltage offset at $0^\circ C$				500		mV
$T_C$	Temperature coefficient (sensor gain)	$T_A = T_J = T_{MIN}$ to $T_{MAX}$		9.7	10	10.3	$mV/^\circ C$
$V_{ONL}$	Output Nonlinearity <sup>(3)</sup>	$T_A = T_J = T_{MIN}$ to $T_{MAX}$	LM50	-0.8		0.8	$^\circ C$
$Z_{OUT}$	Output impedance	$T_A = T_J = T_{MIN}$ to $T_{MAX}$			2000	4000	$\Omega$
$T_{ON}$	Turn-On Time		LM50 (Legacy chip)		5		$\mu s$
			LM50 (New chip)		30		
$T_{LTD}$	Long-term stability and drift <sup>(4)</sup>	$T_J = 125^\circ C$ for 1000 hours	LM50		$\pm 0.08$		$^\circ C$
<b>POWER SUPPLY</b>							
$I_{DD}$	Operating current	$T_A = T_{MIN}$ to $T_{MAX}$ $4.5V \leq +V_S \leq 10V$	LM50 (Legacy chip)		95	180	$\mu A$
			LM50 (New chip)		52	90	
PSR	Line regulation <sup>(5)</sup>	$T_A = T_{MIN}$ to $T_{MAX}$ $4.5V \leq +V_S \leq 10V$	LM50	-1.2		1.2	$mV/V$
$\Delta I_{DD}$	Change of quiescent current	$T_A = T_{MIN}$ to $T_{MAX}$ $4.5V \leq +V_S \leq 10V$	LM50 (Legacy chip)			2	$\mu A$
			LM50 (New chip)			8	
$I_{DD\_TEMP}$	Temperature coefficient of quiescent current	$T_A = T_{MIN}$ to $T_{MAX}$ $4.5V \leq +V_S \leq 10V$	LM50B		1		$\mu A/^\circ C$
			LM50C		2		

(1) Limits are specified to TI's AOQL (Average Outgoing Quality Level).

(2) Accuracy is defined as the error between the output voltage and  $10mV/^\circ C$  multiplied by case temperature of the device plus 500mV, at specified conditions of voltage, current, and temperature (expressed in  $^\circ C$ ).

(3) Nonlinearity is defined as the deviation of the output-voltage-versus-temperature curve from the best-fit straight line, over the rated temperature range of the device.

(4) For best long-term stability, any precision circuit provides best results if the unit is aged at a warm temperature, and/or temperature cycled for at least 46 hours before long-term life test begins. This is especially true when a small (Surface-Mount) part is wave-soldered; allow time for stress relaxation to occur. The majority of the drift occurs in the first 1000 hours at elevated temperatures. The drift after 1000 hours does not continue at the first 1000 hour rate.

(5) Regulation is measured at constant junction temperature, using pulse testing with a low duty cycle. Changes in output due to heating effects can be computed by multiplying the internal dissipation by the thermal resistance.

## 6.6 Electrical Characteristics: LM50HV

LM50HV :  $+V_S = 3V$  to  $36V$  (DC) and no  $I_{LOAD}$ ,  $T_A = -40^\circ C$  to  $150^\circ C$  (unless otherwise noted); Typical specifications are at  $T_A = 25^\circ C$  and  $+V_S = 5V$  (unless otherwise noted)<sup>(1)</sup>

PARAMETER		TEST CONDITIONS		MIN	TYP	MAX	UNIT
<b>SENSOR ACCURACY</b>							
$T_{ACY}$	Temperature accuracy <sup>(2)</sup>	$T_A = 25^\circ C$	LM50HV			$\pm 1$	$^\circ C$
		$T_A = 20^\circ C$ to $70^\circ C$		-2	2		
		$T_A = -10^\circ C$ to $125^\circ C$		-2.5	2.5		
		$T_A = -40^\circ C$ to $125^\circ C$		-3.5	3.5		
		$T_A = -20^\circ C$ to $150^\circ C$ , $3.1V \leq +V_S$		-3	3		
		$T_A = -40^\circ C$ to $150^\circ C$		-3.5	3.5		
<b>SENSOR OUTPUT</b>							
$V_{0^\circ C}$	Output voltage offset at $0^\circ C$			500			mV
$T_C$	Temperature coefficient (sensor gain)	$T_A = -40^\circ C$ to $150^\circ C$		9.7	10	10.3	mV/ $^\circ C$
$V_{ONL}$	Output Nonlinearity <sup>(3)</sup>	$T_A = -40^\circ C$ to $150^\circ C$		-1.2	1.2		$^\circ C$
$Z_{OUT}$	Output impedance	$T_A = -40^\circ C$ to $150^\circ C$		2000		4000	$\Omega$
$T_{ON}$	Turn-On Time	$T_A = 25^\circ C$ , No $C_{LOAD}$ , $t_r = 1\mu s$ of $+V_S$ step		40			$\mu s$
$T_{LTD}$	Long-term stability and drift <sup>(4)</sup>	$T_J = 150^\circ C$ for 300 hours		$\pm 0.25$			$^\circ C$
$C_{LOAD}$	Capacitive load drive	$R_l = 0\Omega$				1	$\mu F$
$t_{RESP\_L}$	Response time (Stirred Liquid)	$\tau = 63\%$ for step response ( $0.5in \times 0.5in$ , 2-layer 62- mil PCB)	From $22^\circ C$ to $100^\circ C$	1.7			s
$t_{RESP\_A}$	Response time (Still Air)		From $18^\circ C$ to $100^\circ C$	15.6			
<b>POWER SUPPLY</b>							
$I_{DD}$	Operating current	$T_A = -40^\circ C$ to $150^\circ C$ $3V \leq +V_S \leq 36V$		52		130	$\mu A$
$I_{OUT-SC}$	Output short-circuit current limit	$V_O$ short-circuit source current				1	mA
PSR	Line regulation <sup>(5)</sup>	$T_A = -40^\circ C$ to $150^\circ C$ $3V \leq +V_S \leq 36V$		-0.6		0.6	mV/V
PSRR	Power supply rejection ratio	$T_A = 25^\circ C$ $+V_S = 3.3V, 5V$ and $12V$	$f = 1MHz$	-25			dB
			$f = 100kHz$	-40			
$\Delta I_{DD}$	Change of quiescent current	$T_A = -40^\circ C$ to $150^\circ C$ $3V \leq +V_S \leq 36V$				30	$\mu A$
$I_{DD\_TEMP}$	Temperature coefficient of quiescent current	$T_A = -40^\circ C$ to $150^\circ C$ $3V \leq +V_S \leq 36V$		0.3			$\mu A/^\circ C$
$V_{ON-TH}$	Turn-on threshold voltage	$T_A = -40^\circ C$ to $150^\circ C$		2.1		2.8	V
$V_{OFF-TH}$	Temperature coefficient of quiescent current	$T_A = -40^\circ C$ to $150^\circ C$		1.7	2.1		V

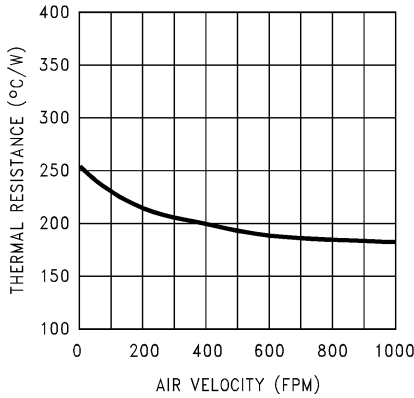
- (1) Limits are specified to TI's AOQL (Average Outgoing Quality Level).
- (2) Accuracy is defined as the error between the output voltage and  $10mV/^\circ C$  multiplied by case temperature of the device plus  $500mV$ , at specified conditions of voltage, current, and temperature (expressed in  $^\circ C$ ).
- (3) Nonlinearity is defined as the deviation of the output-voltage-versus-temperature curve from the best-fit straight line, over the rated temperature range of the device.
- (4) Long term stability and drift is determined using accelerated operational life testing at a junction temperature of  $150^\circ C$ .
- (5) Regulation is measured at constant junction temperature, using pulse testing with a low duty cycle. Changes in output due to heating effects can be computed by multiplying the internal dissipation by the thermal resistance.

**LM50, LM50HV**

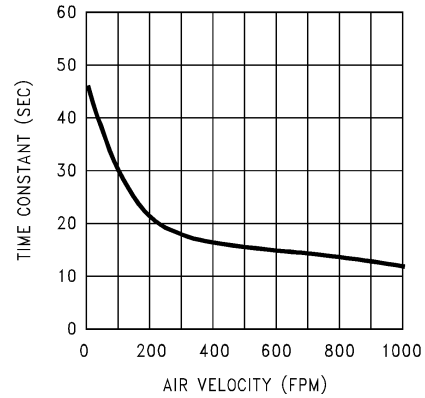
SNIS1181 – JULY 1999 – REVISED OCTOBER 2025

**6.7 Typical Characteristics (LM50B and LM50C)**

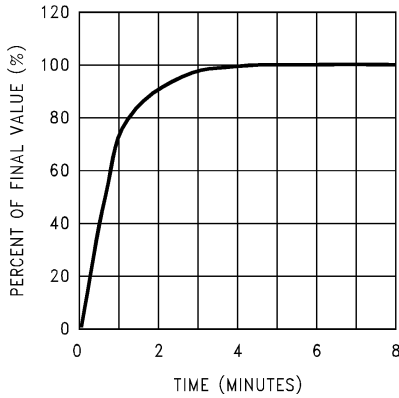
To generate these curves the device is mounted to a printed circuit board as shown in [Figure 8-14](#) or [Figure 8-15](#).



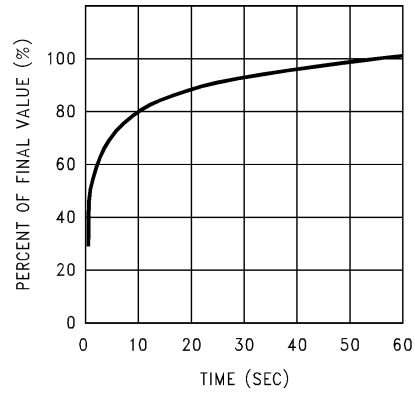
**Figure 6-1. Thermal Resistance Junction-to-Ambient (Legacy chip)**



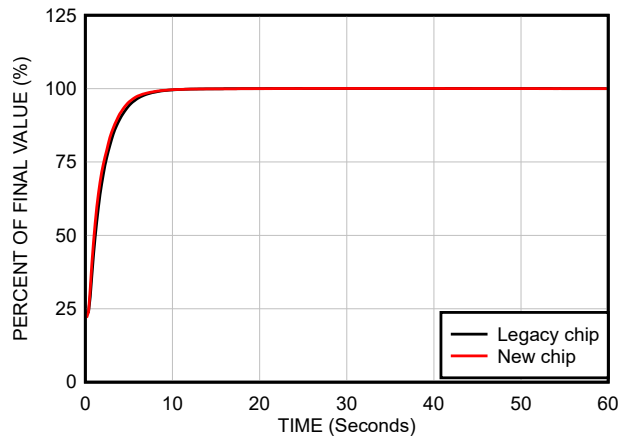
**Figure 6-2. Thermal Time Constant (Legacy chip)**



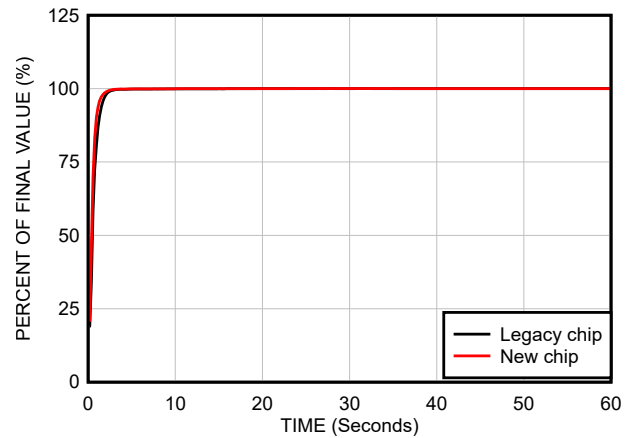
**Figure 6-3. Thermal Response in Still Air With Heat Sink (Legacy chip)**



**Figure 6-4. Thermal Response in Stirred Oil Bath With Heat Sink (Legacy chip)**



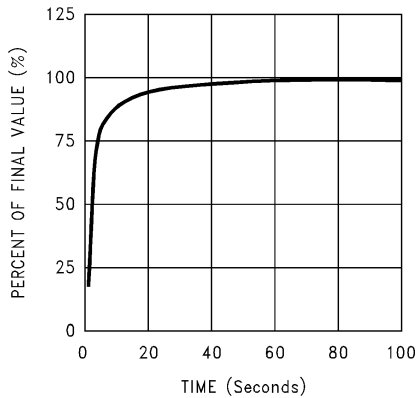
**Figure 6-5. Thermal Response in Stirred Oil Bath With Heat Sink (0.5 inches x 0.5 inches PCB board)**



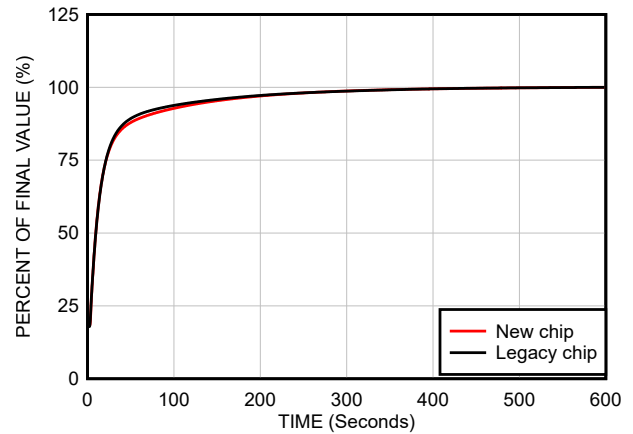
**Figure 6-6. Thermal Response in Stirred Oil Bath Without Heat Sink**

## 6.7 Typical Characteristics (LM50B and LM50C) (continued)

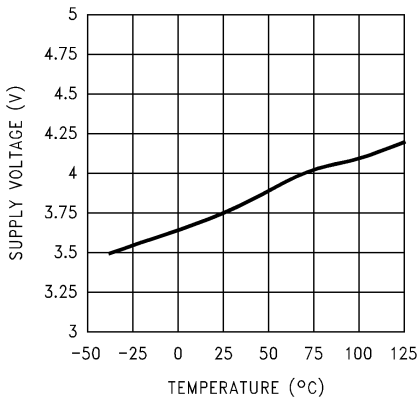
To generate these curves the device is mounted to a printed circuit board as shown in [Figure 8-14](#) or [Figure 8-15](#).



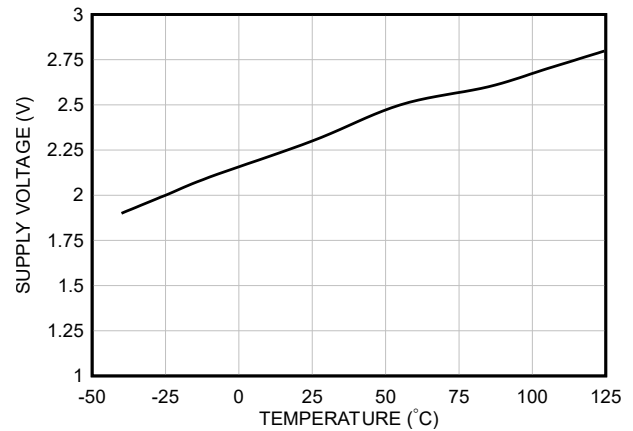
**Figure 6-7. Thermal Response in Still Air Without a Heat Sink (Legacy chip)**



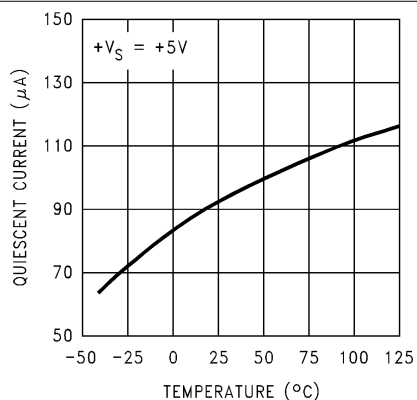
**Figure 6-8. Thermal Response in Still Air Without a Heat Sink (Both Legacy and New Chip in the New Test Setup)**



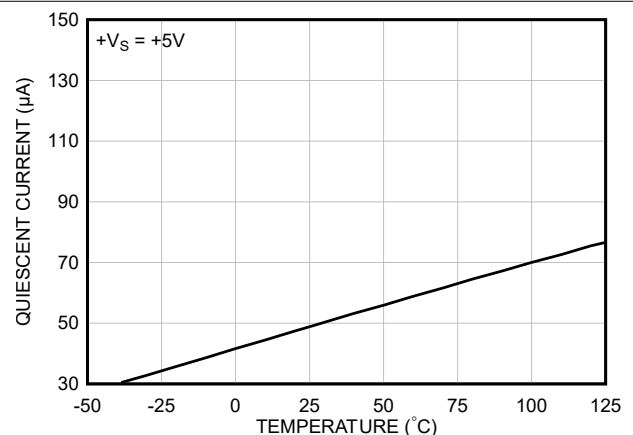
**Figure 6-9. Start-Up Voltage vs Temperature (Legacy chip)**



**Figure 6-10. Start-Up Voltage vs Temperature (New chip)**



**Figure 6-11. Quiescent Current vs Temperature (Legacy chip)**



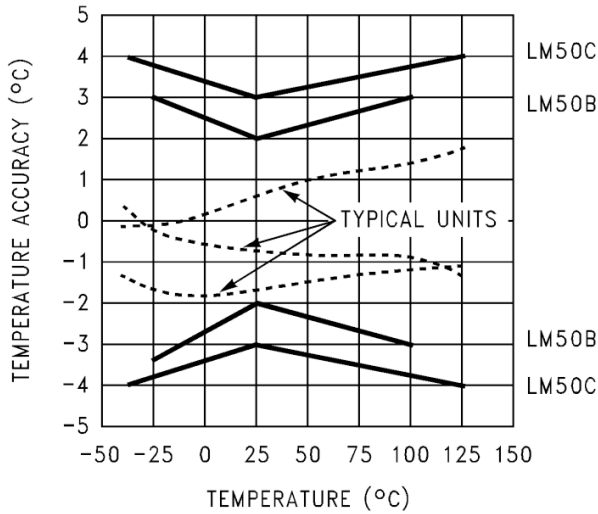
**Figure 6-12. Quiescent Current vs Temperature (New chip)**

**LM50, LM50HV**

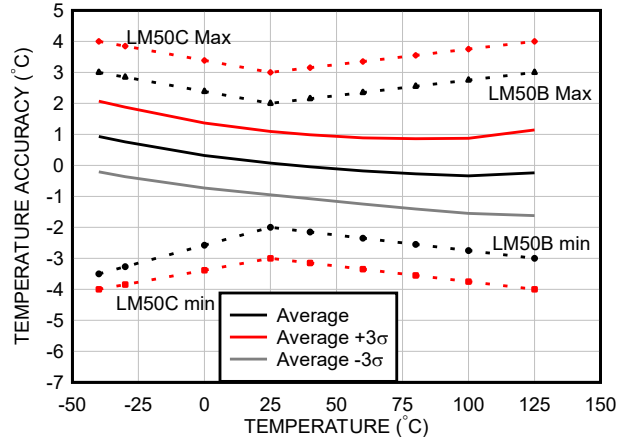
SNIS118I – JULY 1999 – REVISED OCTOBER 2025

**6.7 Typical Characteristics (LM50B and LM50C) (continued)**

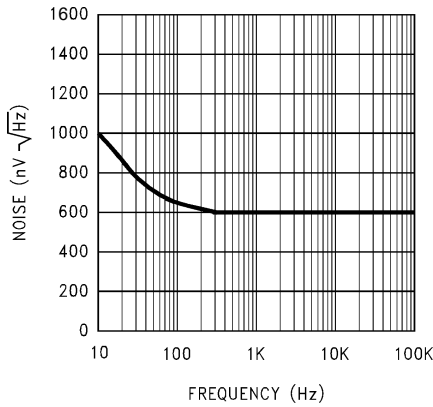
To generate these curves the device is mounted to a printed circuit board as shown in [Figure 8-14](#) or [Figure 8-15](#).



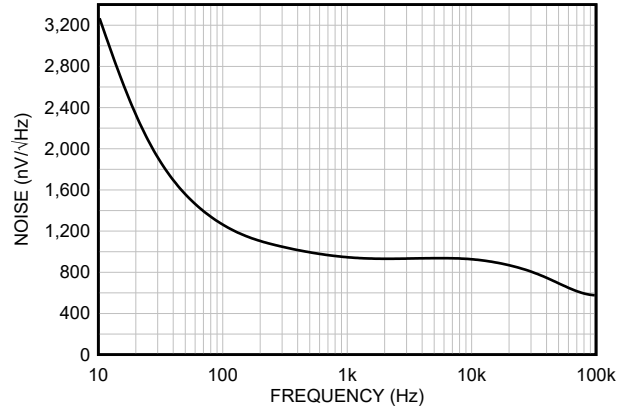
**Figure 6-13. Accuracy vs Temperature (Legacy chip)**



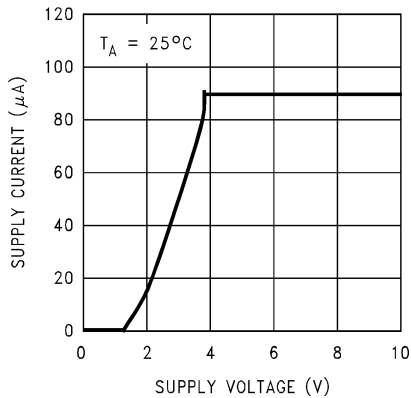
**Figure 6-14. Accuracy vs Temperature (New chip)**



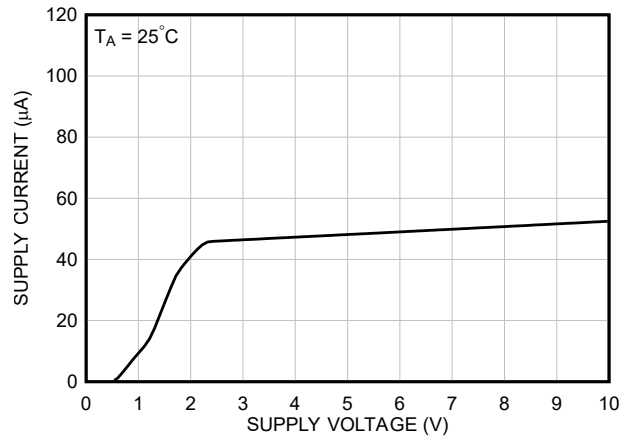
**Figure 6-15. Noise Voltage (Legacy chip)**



**Figure 6-16. Noise Voltage (New chip)**



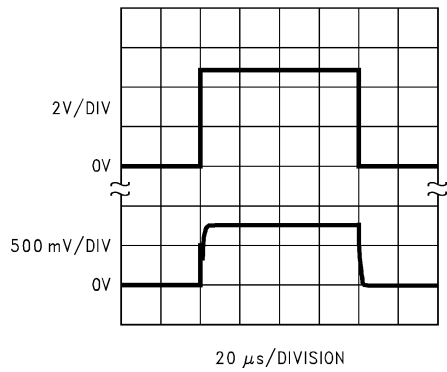
**Figure 6-17. Supply Current vs Supply Voltage (Legacy chip)**



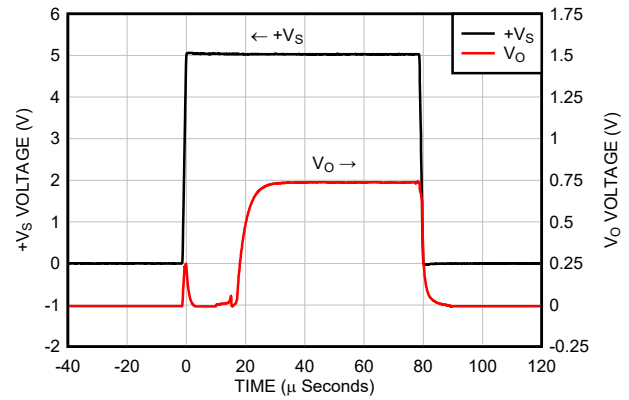
**Figure 6-18. Supply Current vs Supply Voltage (New chip)**

## 6.7 Typical Characteristics (LM50B and LM50C) (continued)

To generate these curves the device is mounted to a printed circuit board as shown in [Figure 8-14](#) or [Figure 8-15](#).



**Figure 6-19. Start-Up Response (Legacy chip)**



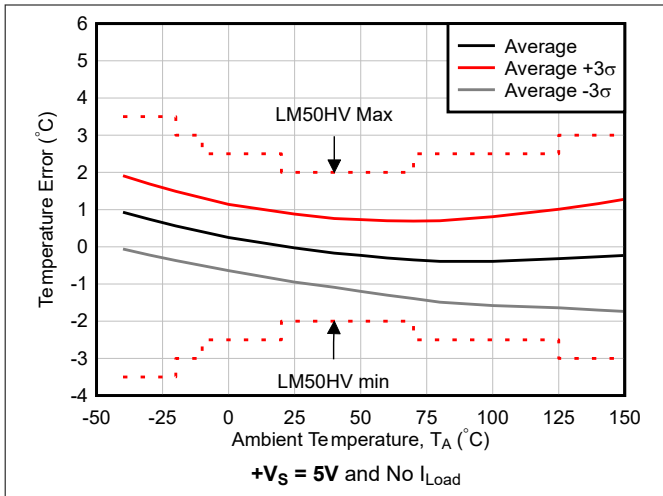
**Figure 6-20. Start-Up Response (New chip)**

**LM50, LM50HV**

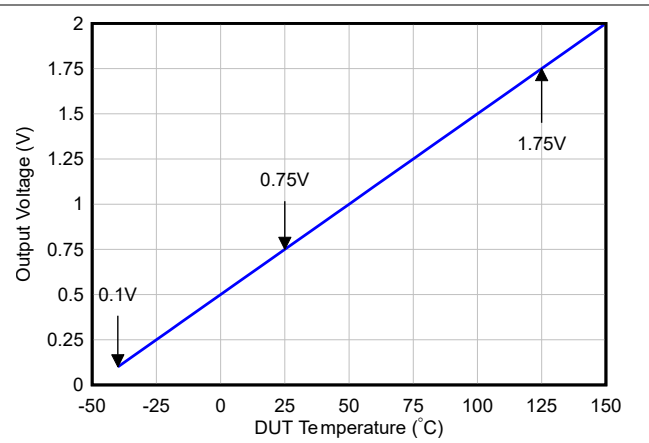
SNIS1181 – JULY 1999 – REVISED OCTOBER 2025

**6.8 Typical Characteristics (LM50HV)**

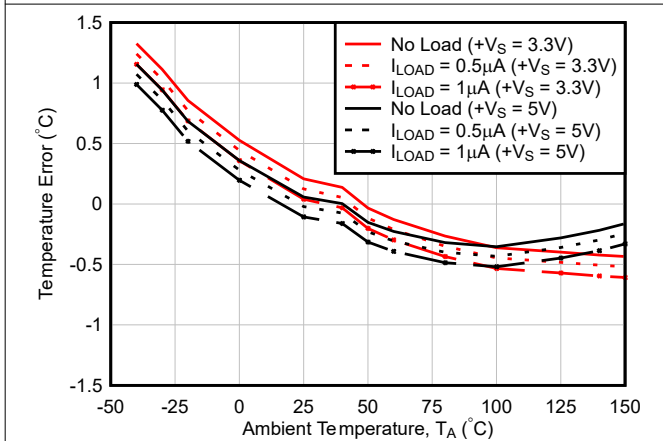
At  $T_A = 25^\circ\text{C}$  and  $+V_S = 5\text{V}$  (unless otherwise noted)



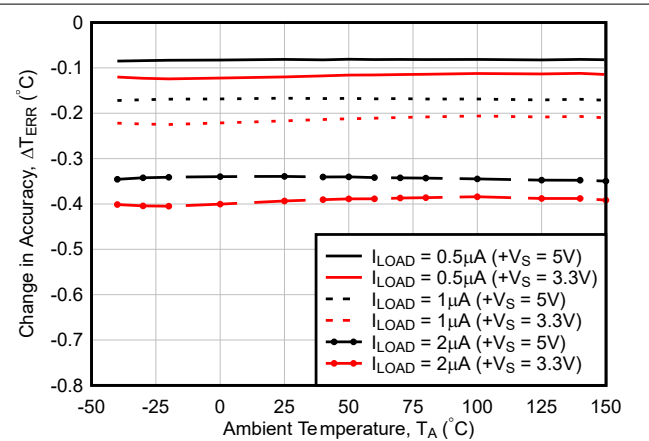
**Figure 6-21. Accuracy vs Ambient Temperature**



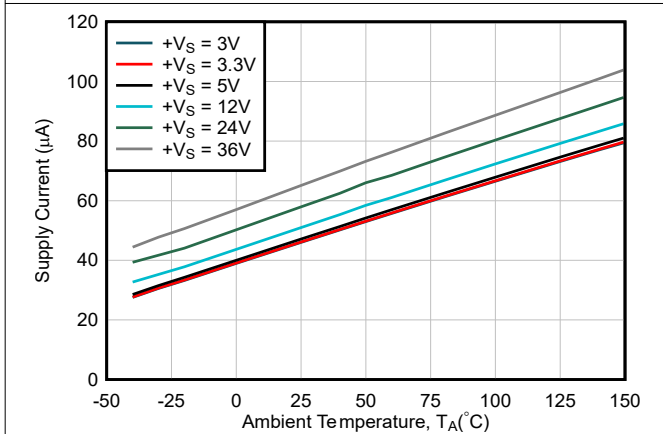
**Figure 6-22.  $V_O$  vs Ambient Temperature**



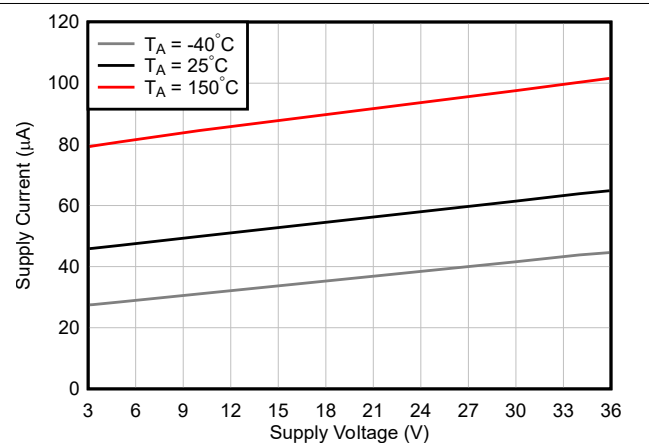
**Figure 6-23. Accuracy vs Ambient Temperature with different loads**



**Figure 6-24. Change in Accuracy vs Temperature**



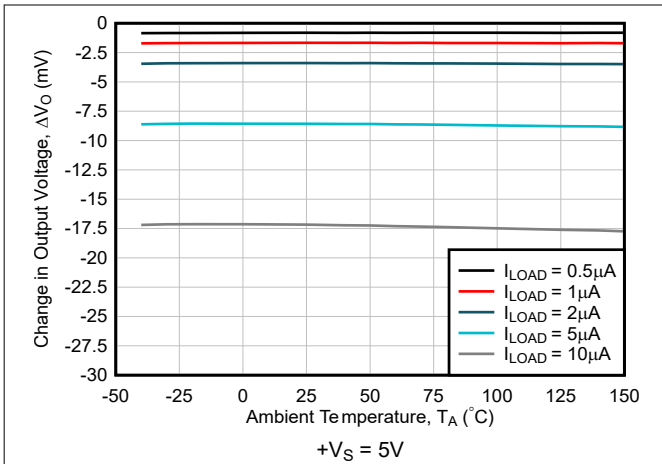
**Figure 6-25. Supply Current vs Ambient Temperature**



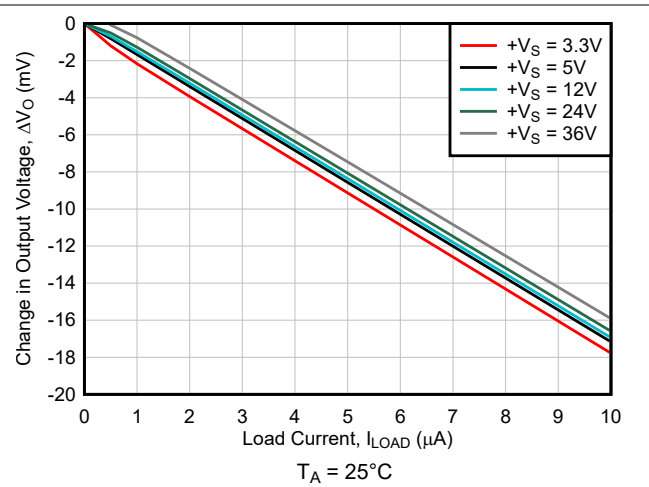
**Figure 6-26. Supply Current vs Supply Voltage**

### 6.8 Typical Characteristics (LM50HV) (continued)

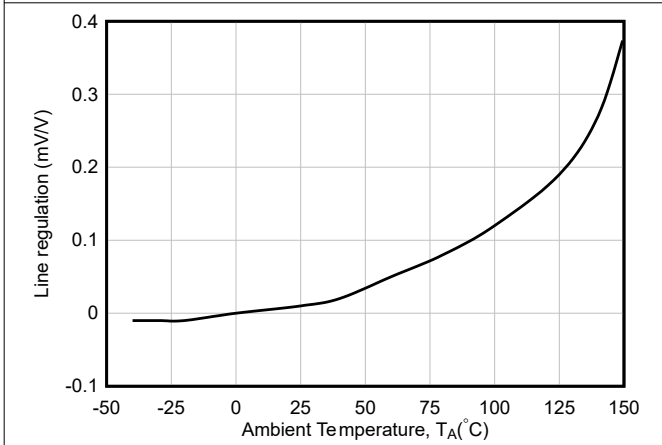
At  $T_A = 25^\circ\text{C}$  and  $+V_S = 5\text{V}$  (unless otherwise noted)



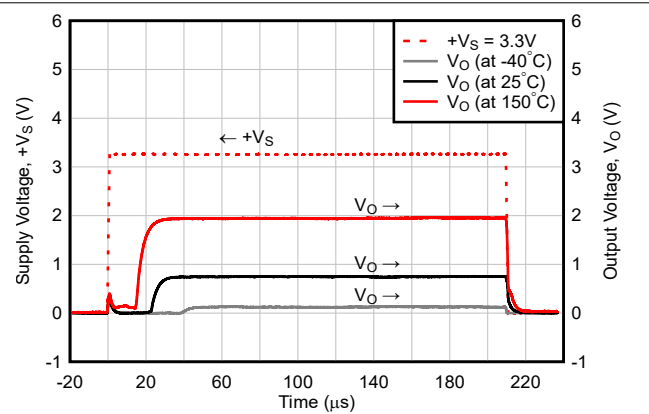
**Figure 6-27. Load Regulation vs Ambient Temperature**



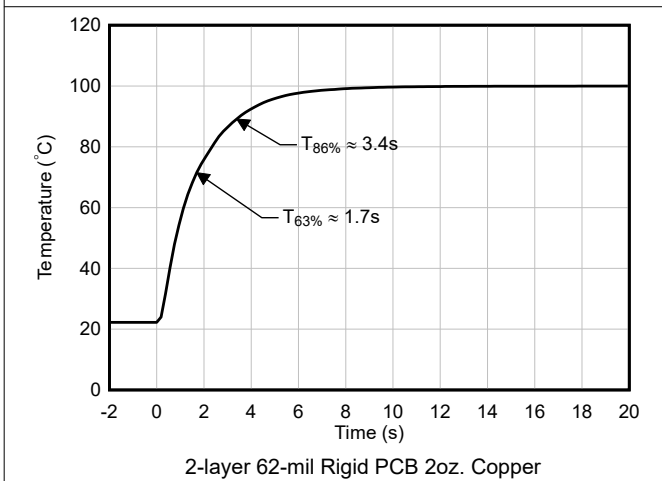
**Figure 6-28. Change in Output Voltage vs Load Current**



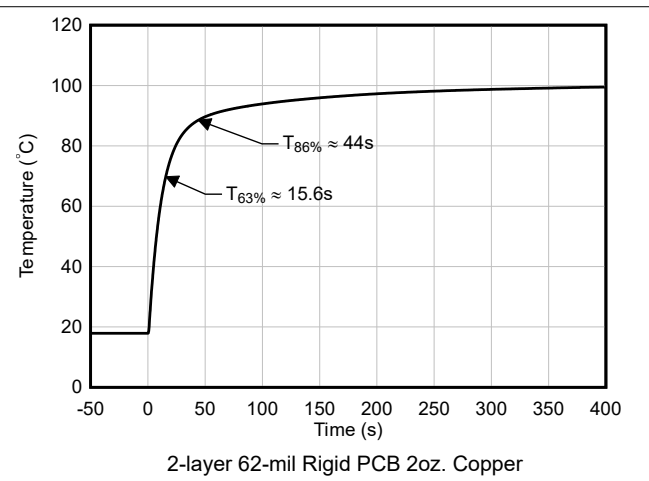
**Figure 6-29. Line Regulation vs Ambient Temperature**



**Figure 6-30. Start-up response to  $+V_S = 3.3\text{V}$  Step (When  $t_r = 1\mu\text{s}$ , No  $C_{\text{Load}}$  and  $C_{\text{By-pass}}$ )**



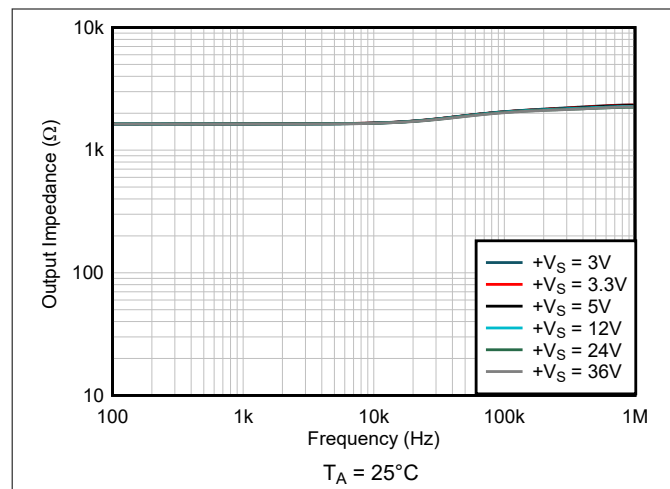
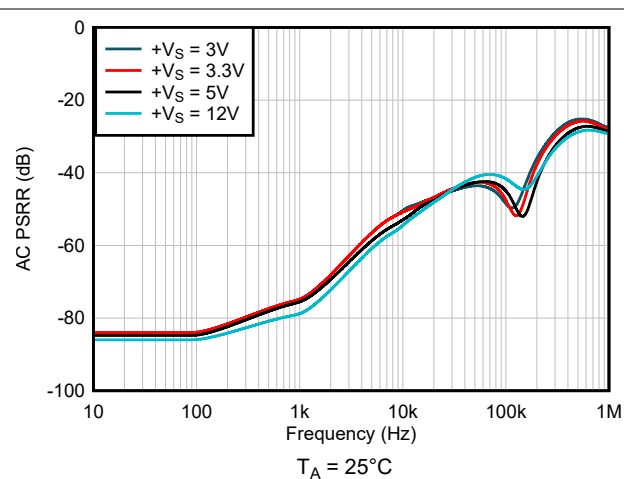
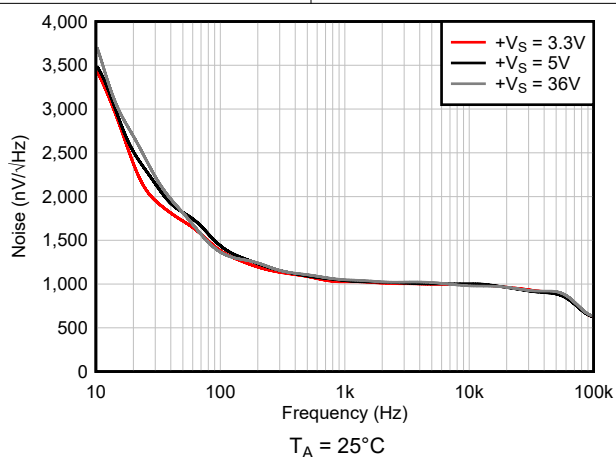
**Figure 6-31. Thermal Response in Stirred Oil Bath (0.5 inches × 0.5 inches PCB board)**



**Figure 6-32. Thermal Response in Still Air (0.5 inches × 0.5 inches PCB board)**

**LM50, LM50HV**

SNIS1181 – JULY 1999 – REVISED OCTOBER 2025

**6.8 Typical Characteristics (LM50HV) (continued)**At  $T_A = 25^\circ\text{C}$  and  $+V_S = 5\text{V}$  (unless otherwise noted)**Figure 6-33. Output Impedance vs Frequency****Figure 6-34. Power Supply Rejection Ratio vs Frequency****Figure 6-35. Output Noise Density**

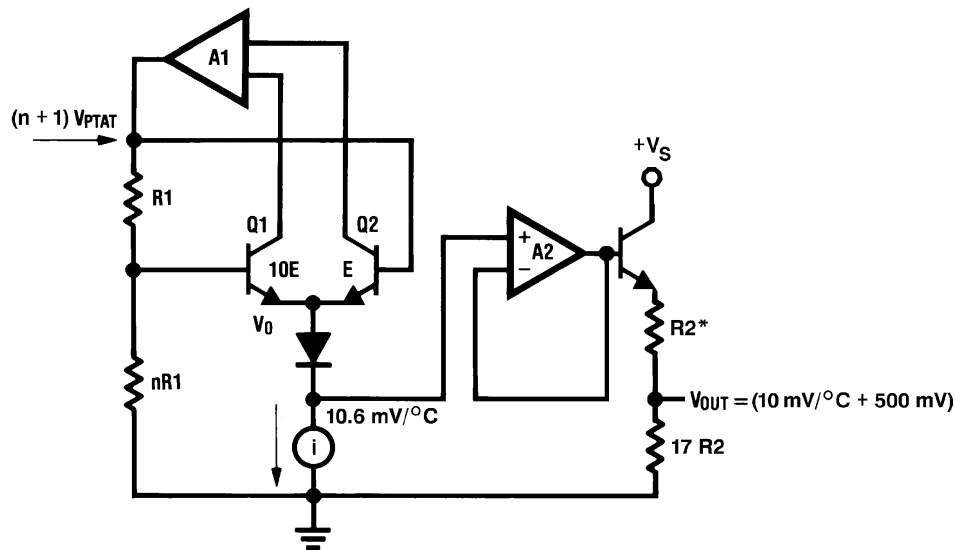
## 7 Detailed Description

### 7.1 Overview

The LM50 and LM50HV devices are precision integrated-circuit temperature sensor that can sense a  $-40^{\circ}\text{C}$  to  $125^{\circ}\text{C}$  (for LM50) or  $-40^{\circ}\text{C}$  to  $150^{\circ}\text{C}$  (for LM50HV) temperature range using a single positive supply. The output voltage of the LM50 and LM50HV has a positive temperature slope of  $10\text{mV}/^{\circ}\text{C}$ . A  $500\text{mV}$  offset is included enabling negative temperature sensing when biased by a single supply.

The temperature-sensing element is comprised of a delta- $V_{\text{BE}}$  architecture. The temperature-sensing element is then buffered by an amplifier and provided to the  $V_{\text{O}}$  pin. The amplifier has a simple class A output stage with typical  $2\text{k}\Omega$  output impedance as shown in the [Functional Block Diagram](#).

### 7.2 Functional Block Diagram



\* $R2 \cong 2\text{k}$  with a typical  $1300\text{ppm}/^{\circ}\text{C}$  drift.

### 7.3 Feature Description

#### 7.3.1 LM50 and LM50HV Transfer Function

The LM50 and LM50HV follow a simple linear transfer function to achieve the accuracy as listed in the [Section 6.5](#) and [Section 6.6](#) tables.

Use [Equation 1](#) to calculate the value of  $V_{\text{O}}$ .

$$V_{\text{O}} = 10\text{mV}/^{\circ}\text{C} \times T^{\circ}\text{C} + 500\text{mV} \quad (1)$$

where

- $T$  is the temperature in  $^{\circ}\text{C}$
- $V_{\text{O}}$  is the LM50 and LM50HV output voltage

### 7.4 Device Functional Modes

The only functional mode of the device has an analog output directly proportional to temperature.

**LM50, LM50HV**

SNIS118I – JULY 1999 – REVISED OCTOBER 2025

## 8 Application and Implementation

### Note

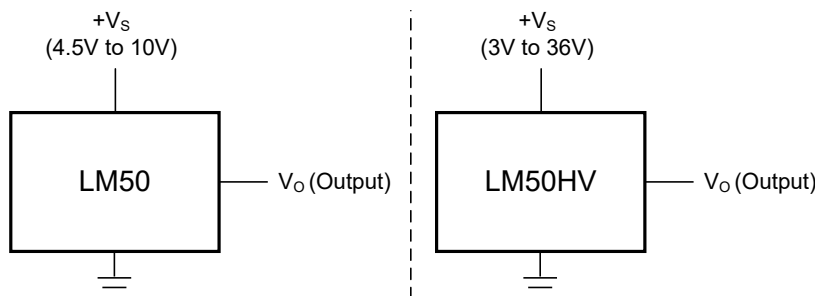
Information in the following applications sections is not part of the TI component specification, and TI does not warrant its accuracy or completeness. TI's customers are responsible for determining suitability of components for their purposes, as well as validating and testing their design implementation to confirm system functionality.

### 8.1 Application Information

The LM50 and LM50HV have a wide supply range and a 10mV/°C output slope with a 500mV DC offset. Therefore, these devices can be easily placed in many temperature-sensing applications where a single supply is required for positive and negative temperatures. The LM50HV device is designed for LDO-less applications with power supply rails of 12V, 24V, 36V due to stable functionality across wide supply range of 3V to 36V.

### 8.2 Typical Application

#### 8.2.1 Full-Range Centigrade Temperature Sensor



**Figure 8-1. Full-Range Centigrade Temperature Sensor LM50 (–40°C to 125°C) and LM50HV (–40°C to 150°C)**

##### 8.2.1.1 Design Requirements

For this design example, use the parameters listed in [Table 8-1](#) as the input parameters.

**Table 8-1. Design Parameters**

PARAMETER	VALUE (LM50)	VALUE (LM50HV)
Power supply voltage	4.5V to 10V	3V to 36V
Output impedance	4kΩ (maximum)	4kΩ (maximum)
Accuracy at 25°C	±2°C/±3°C (maximum)	±1°C (typical)
Accuracy over –10°C to 125°C	–3.5/+3°C/±4°C (maximum)	±2.5°C (maximum)
Accuracy over –40°C to 125°C		±3.5°C (maximum)
Accuracy over –20°C to 150°C	-	±3°C (maximum)
Accuracy over –40°C to 150°C	-	±3.5°C (maximum)
Temperature slope	10mV/°C	10mV/°C

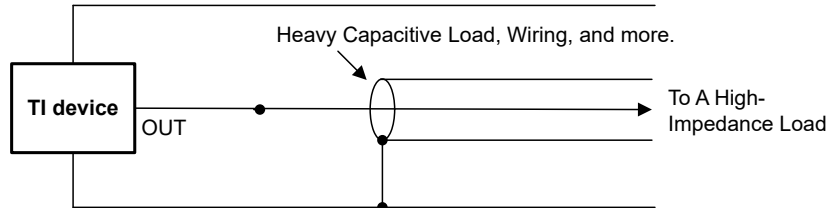
##### 8.2.1.2 Detailed Design Procedure

The LM50 and LM50HV are simple temperature sensors that provide an analog output. Therefore design requirements related to layout are more important than other requirements. See [Layout](#) for more information.

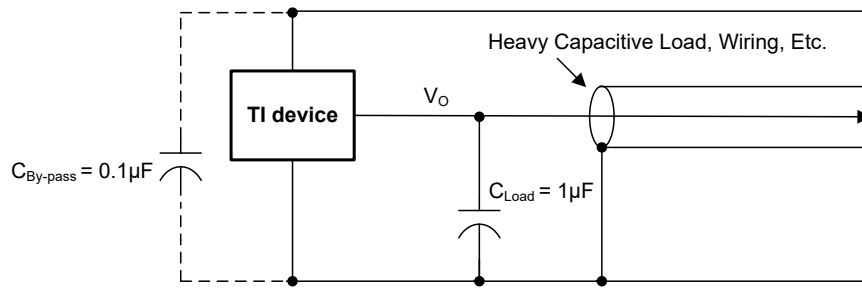
###### 8.2.1.2.1 Capacitive Bypass and Loads

The LM50 and LM50HV devices handle capacitive loading very well. Without any special precautions, the LM50 and LM50HV can drive capacitive load up to 1μF. These devices have a nominal 2kΩ output impedance (shown in [Functional Block Diagram](#)). The temperature coefficient of the output resistors is approximately 1300ppm/°C.

Taking into account this temperature coefficient and the initial tolerance of the resistors, the output impedance of the device does not exceed  $4\text{k}\Omega$ . In an extremely noisy environment adding filtering can be necessary to minimize noise pickup. TI recommends adding a  $C_{\text{By-pass}} = 0.1\mu\text{F}$  capacitor between  $+V_S$  and GND to bypass the power supply noise voltage, as shown in Figure 8-3. Adding a capacitor ( $C_{\text{Load}}$ ) from  $V_O$  to ground can be necessary. A  $1\mu\text{F}$  output capacitor with the  $4\text{k}\Omega$  output impedance forms a  $40\text{Hz}$  low-pass filter. Because the thermal time constant of the LM50 and LM50HV is much slower than the  $25\text{ms}$  time constant formed by the RC, the overall response time of the device is not significantly affected. For much larger capacitors, this additional time lag increases the overall response time of the LM50 and LM50HV.

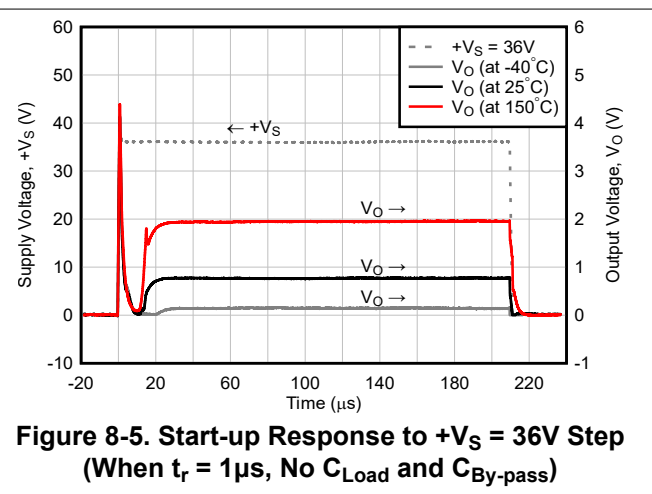
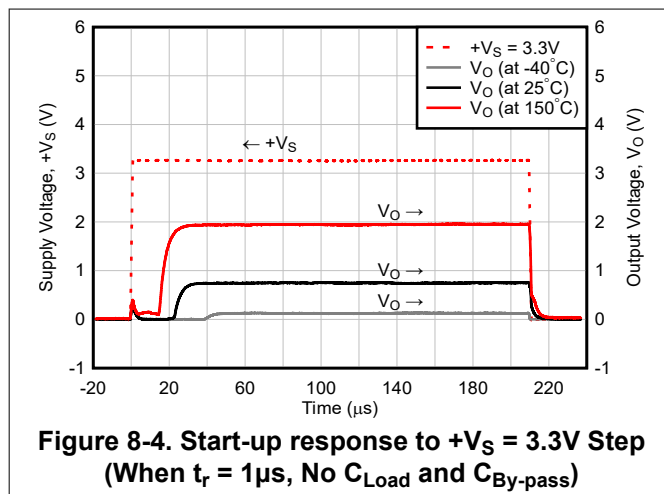


**Figure 8-2. LM50 and LM50HV No Decoupling Required for Capacitive Load**



**Figure 8-3. LM50 and LM50HV With Filter for Noisy Environment**

To avoid glitch of start-up power supply (input) response especially when  $C_{\text{By-pass}}$  is not used (as shown in Figure 6-20, Figure 8-4 and Figure 8-5) on LM50 (new chip) and LM50HV devices, a minimum  $C_{\text{Load}}$  must be placed between  $V_O$  and ground especially when LM50 (new chip) and LM50HV devices are utilized in the comparator circuits.



The minimum  $C_{\text{Load}}$  capacitor is varied over different operating temperature range and power supply ramp rate as shown in the Table 8-2. Please noted that the rise time ( $t_r$ ) can be translated to ramp rate of power supply (SR) by:  $\text{SR} (\text{V}/\mu\text{s}) = 0.8 \times +V_S (\text{V}) / t_r (\mu\text{s})$ .

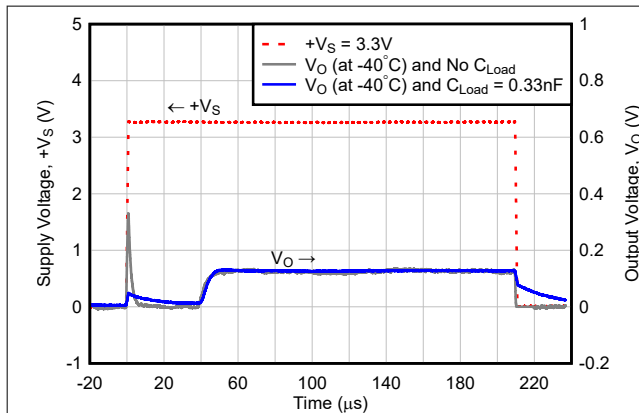
**LM50, LM50HV**

SNIS1181 – JULY 1999 – REVISED OCTOBER 2025

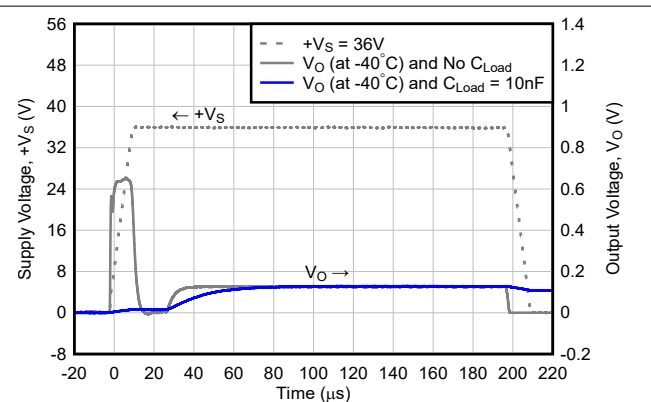
**Table 8-2. Minimum Required  $C_{Load}$  to Avoid Glitch Overshoot Over Power Supply Start-up Step Response (without  $C_{By-pass}$ )**

Load Capacitance	$+V_S = 3.3V$		$+V_S = 5V$		$+V_S = 36V$	
	$t_r = 0.1\mu s$	$t_r = 1\mu s$	$t_r = 0.1\mu s$	$t_r = 1\mu s$	$t_r = 0.1\mu s$	$t_r = 1\mu s$
$C_{Load}$ (min) at $T_A = -40^\circ C$	0.33nF	0.33nF	0.47nF	0.47nF	10nF	10nF
$C_{Load}$ (min) at $T_A = 25^\circ C$	0.02nF	NA	0.05nF	0.05nF	0.68nF	0.68nF
$C_{Load}$ (min) at $T_A = 150^\circ C$	NA	NA	NA	NA	0.12nF	0.12nF

Figure 8-6 and Figure 8-7 show start-up step response to 3.3V and 36V power supply with around  $3.3V/\mu s$  ramp rate (without using  $C_{By-pass}$ ). Each figure shows the output response to no load and minimum required  $C_{Load}$  when glitch overshoot is eliminated. The worst-case scenario (as shown in Table 8-2) is happened when operating temperature is  $-40^\circ C$ .



**Figure 8-6. Start-up Response to  $+V_S = 3.3V$  Step Without  $C_{By-pass}$  When  $SR = 3.3V/\mu s$  (With No  $C_{Load}$  and  $C_{Load} = 0.33nF$ )**



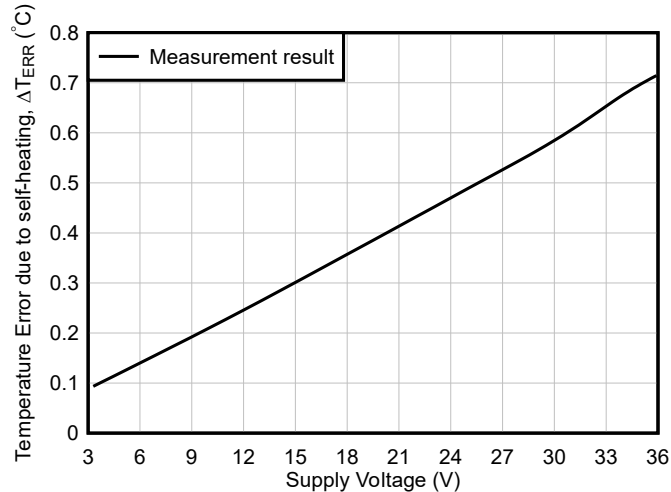
**Figure 8-7. Start-up Response to  $+V_S = 36V$  Step Without  $C_{By-pass}$  When  $SR = 3.3V/\mu s$  (With No  $C_{Load}$  and  $C_{Load} = 10nF$ )**

**Note**

TI suggests adding a minimum  $0.1\mu F$   $C_{By-pass}$  (between  $+V_S$  and GND) and/or a  $0.1\mu F$   $C_{Load}$  (between  $V_O$  and GND) capacitors to avoid supply noise and glitch overshoot.

**8.2.1.2.2 LM50HV Self-heating**

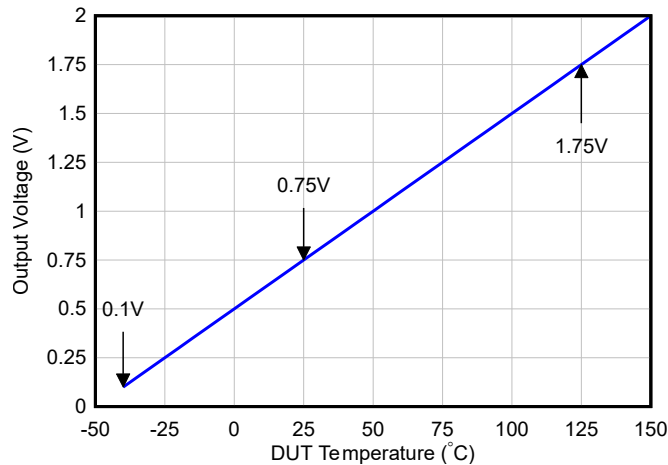
The LM50HV temperature accuracy error (due to self-heating) versus power supply is shown in Figure 8-8. The device is soldered to 30-gauge wire in this measurement and the temperature is read after consistently 10 minutes working of the device at  $25^\circ C$ . Since temperature error is directly proportional to thermal resistance ( $R_{th}$ ) and power ( $+V_S \times I_{DD}$ ), the temperature error is increased by changing power supply from 3V to 36V. By considering junction-to-ambient thermal resistance value in Section 6.4 and supply current vs supply voltage in Figure 6-26, temperature error around  $\pm 0.15^\circ C$  should be expected (for up to 36V power supply) between calculated value ( $\Delta T_{ERR} (^\circ C) = R_{th} \times (+V_S) \times I_{DD}$ ) and measured value shown in Figure 8-8. This possible deviation is due to hard controlling of air temperature and humidity, position of the device on the test setup and other factors which are addressed in *Analyzing PCB Thermal Resistance in High-Accuracy Temperature Sensors* application note.



The device soldered to 30 gauge wire. The accuracy is read after consistently 10min working of the device at 25°C.

**Figure 8-8. Accuracy (Due to Self-heating) vs Supply Voltage**

### 8.2.1.3 Application Curve



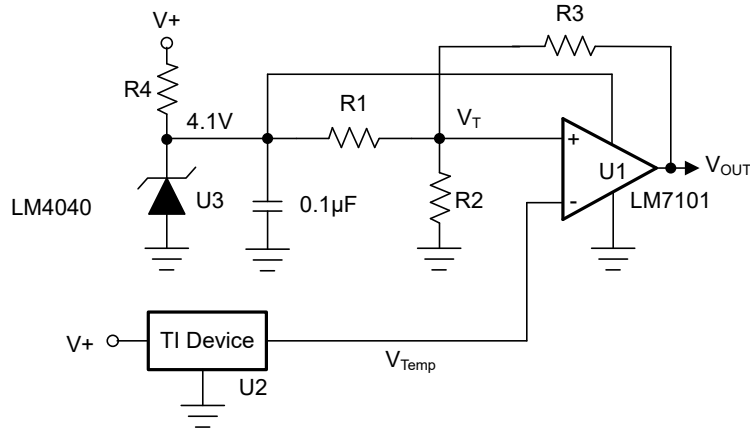
**Figure 8-9. Output Transfer Function**

## 8.3 System Examples

Figure 8-10 to Figure 8-12 show application circuit examples using the LM50 and LM50HV devices. Figure 8-10 shows a Centigrade Thermostat or Fan Controller configuration based on Schmitt trigger circuit. LM50 and LM50HV devices can detect the ambient temperature in which the upper and lower temperature thresholds can be adjusted by R1, R2 and R3 resistors.

**LM50, LM50HV**

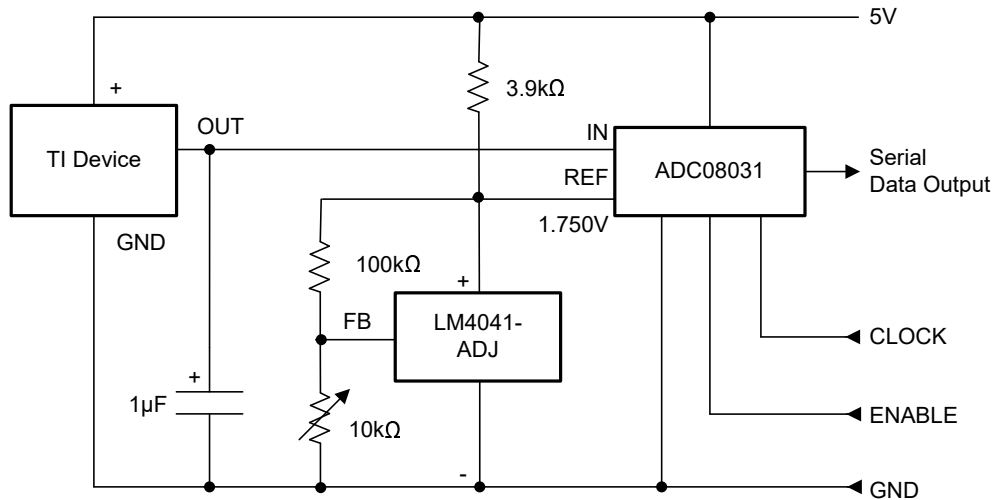
SNIS1181 – JULY 1999 – REVISED OCTOBER 2025



Copyright © 2016, Texas Instruments Incorporated

**Figure 8-10. Centigrade Thermostat or Fan Controller**

The LM50/LM50HV output voltage can be digitized by using ADC and voltage reference (LM4041) as shown in Figure 8-11.



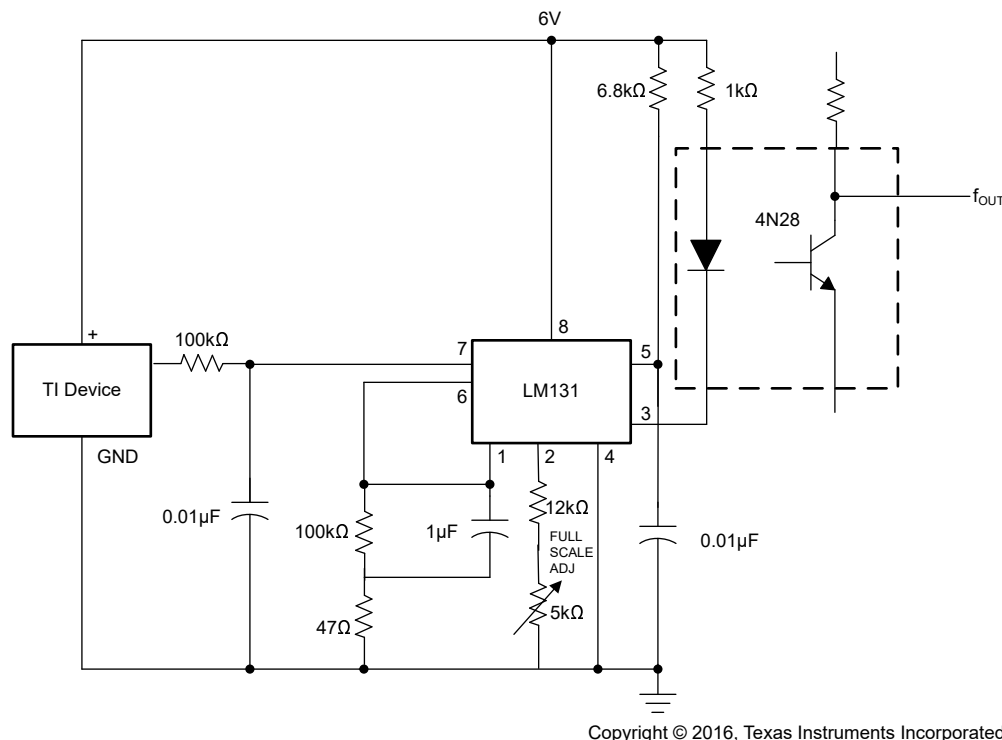
Copyright © 2016, Texas Instruments Incorporated

125°C full scale

**Figure 8-11. Temperature To Digital Converter (Serial Output)**

The temperature detected by LM50/LM50HV can be converted to frequency by using LM131. The desired frequency range can be adjusted by selecting different values for resistors and capacitors while Figure 8-12 shows an example for converting -40°C to 125°C temperature range to 100Hz to 1.75kHz frequency range.

Customers must fully validate and test any circuit before implementing a design based on an example in this section. Unless otherwise noted, the design procedures in [Full-Range Centigrade Temperature Sensor](#) are applicable.



Copyright © 2016, Texas Instruments Incorporated

-40°C to 125°C; 100Hz to 1750Hz

**Figure 8-12. LM50 and LM50HV With Voltage-To-Frequency Converter and Isolated Output**

## 8.4 Power Supply Recommendations

In an extremely noisy environment, adding some filtering to minimize noise pickup can be necessary. TI recommends that a 0.1μF capacitor be added from +V<sub>S</sub> to GND to bypass the power supply voltage, as shown in Figure 8-3.

## 8.5 Layout

### 8.5.1 Layout Guidelines

The LM50 and LM50HV can be applied easily in the same way as other integrated-circuit temperature sensors. The device can be glued or cemented to a surface and the temperature is within about 0.2°C (for power supply up to 10V) of the surface temperature.

This presumes that the ambient air temperature is approximately the same as the surface temperature; if the air temperature are much higher or lower than the surface temperature, the actual temperature of the LM50 and LM50HV dies are at an intermediate temperature between the surface temperature and the air temperature.

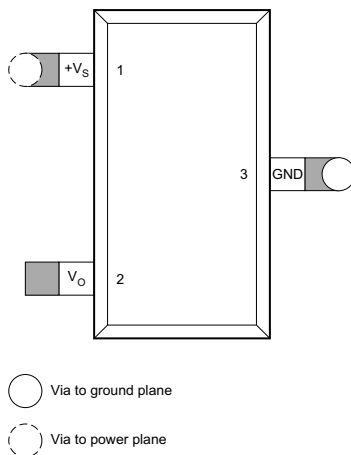
To provide good thermal conductivity, the backside of the LM50 and LM50HV dies are directly attached to the GND pin. The lands and traces to the device is part of the printed-circuit board, which is the object whose temperature is being measured. These printed-circuit board lands and traces do not cause the LM50 and LM50HV temperature to deviate from the desired temperature.

Alternatively, the LM50 and LM50HV can be mounted inside a sealed-end metal tube, and can then be dipped into a bath or screwed into a threaded hole in a tank. As with any device, the LM50 and LM50HV and accompanying wiring and circuits must be kept insulated and dry, to avoid leakage and corrosion. This is especially true if the circuit can operate at cold temperatures where condensation can occur. Printed-circuit coatings and varnishes such as HUMISEAL® and epoxy paints or dips are often used to verify that moisture cannot corrode the device or the connections.

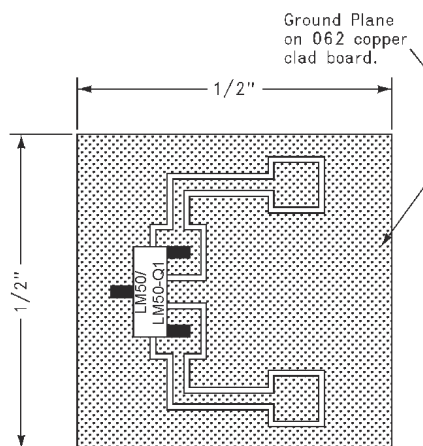
**LM50, LM50HV**

SNIS1181 – JULY 1999 – REVISED OCTOBER 2025

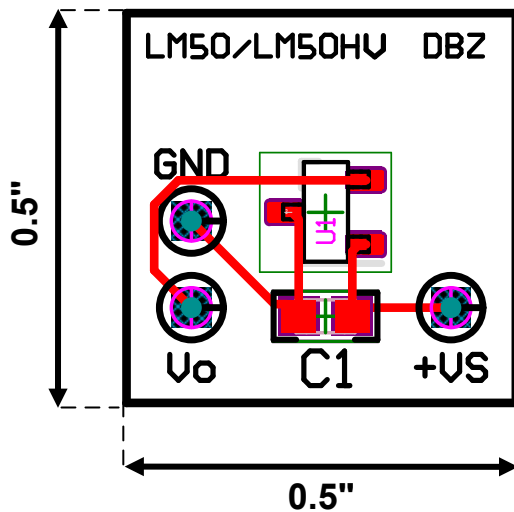
**8.5.2 Layout Example**



**Figure 8-13. PCB Layout**



**Figure 8-14. Printed-Circuit Board Used for Heat Sink to Generate Thermal Response Curves LM50 (Legacy Chip)**



**Figure 8-15. Printed-Circuit Board Used to Generate Thermal Response Curves [New Test Setup for LM50 (New Chip and Legacy Chip) and LM50HV]**

### 8.5.3 Thermal Considerations

Table 8-3 summarizes the thermal resistance of the LM50 (Legacy chip) only for different conditions.

**Table 8-3. Temperature Rise of LM50 (Legacy chip) only Due to Self-Heating**

			$R_{\theta JA}$ (°C/W)
SOT-23	No heat sink <sup>(1)</sup>	Still air (Legacy chip)	291.9
		Moving air (Legacy chip)	-
	Small heat fin <sup>(2)</sup>	Still air (Legacy chip)	260
		Moving air (Legacy chip)	180

(1) Part soldered to 30 gauge wire.

(2) Heat sink used is 0.5inch, square printed-circuit board with 2oz foil; part attached as shown in [Figure 8-14](#).

**LM50, LM50HV**

SNIS118I – JULY 1999 – REVISED OCTOBER 2025

## 9 Device and Documentation Support

### 9.1 Documentation Support

#### Related Documentation

For related documentation see the following:

- Texas Instruments, [TMP23x Low-Power, High-Accuracy Analog Output Temperature Sensors](#), data sheet
- Texas Instruments, [ISOTMP35 ±1.2°C, 3-kVRMS Isolated Temperature Sensor With Analog Output With < 2 Seconds Response Time and 500VRMS Working Voltage](#), data sheet
- Texas Instruments, [LM60 2.7V, SOT-23 or TO-92 Temperature Sensor](#), data sheet
- Texas Instruments, [Tiny Temperature Sensors for Remote Systems](#), application note
- Texas Instruments, [Semiconductor Temperature Sensors Challenge Precision RTDs and Thermistors in Building Automation](#), application note
- Texas Instruments, [LM50HV Evaluation Module](#), EVM
- Texas Instruments, [LMT90 Temperature Sensor Evaluation Module](#), EVM

### 9.2 Receiving Notification of Documentation Updates

To receive notification of documentation updates, navigate to the device product folder on [ti.com](http://ti.com). Click on *Notifications* to register and receive a weekly digest of any product information that has changed. For change details, review the revision history included in any revised document.

### 9.3 Support Resources

[TI E2E™ support forums](#) are an engineer's go-to source for fast, verified answers and design help — straight from the experts. Search existing answers or ask your own question to get the quick design help you need.

Linked content is provided "AS IS" by the respective contributors. They do not constitute TI specifications and do not necessarily reflect TI's views; see TI's [Terms of Use](#).

### 9.4 Trademarks

TI E2E™ is a trademark of Texas Instruments.

HUMISEAL® is a registered trademark of Columbia Chase Corporation.

All trademarks are the property of their respective owners.

### 9.5 Electrostatic Discharge Caution



This integrated circuit can be damaged by ESD. Texas Instruments recommends that all integrated circuits be handled with appropriate precautions. Failure to observe proper handling and installation procedures can cause damage.

ESD damage can range from subtle performance degradation to complete device failure. Precision integrated circuits may be more susceptible to damage because very small parametric changes could cause the device not to meet its published specifications.

### 9.6 Glossary

[TI Glossary](#) This glossary lists and explains terms, acronyms, and definitions.

## 10 Revision History

NOTE: Page numbers for previous revisions may differ from page numbers in the current version.

Changes from Revision H (May 2025) to Revision I (October 2025)	Page
• Added the LM50HV device throughout the document; updated the data sheet title.....	1

Changes from Revision G (January 2017) to Revision H (May 2025)	Page
• Updated the numbering format for tables, figures, and cross-references throughout the document.....	1
• Moved the automotive device to a standalone data sheet ( <a href="#">SNIS249</a> ).....	1

• Added specifications and graphs for the New Device and comparison of the Legacy Device throughout the document .....	1
• Added <i>Device Comparison</i> , <i>Device Orderable Options</i> , and <i>Nomenclature Details</i> tables.....	3
• Deleted Machine Model (MM) Electrostatic discharge.....	5
• Changed the specified temperature range for LM50B from -25°C to 100°C (in the legacy chip) to -40°C to 125°C (in the new chip).....	5
• Added DBZ package “Thermal Information” for the New chip.....	5
• Added “Turn-on Time” for both Legacy chip and New chip.....	6
• Added “ <i>Operating current</i> ” and “ <i>Change of quiescent current</i> ” for the New chip.....	6
• Updated the <i>Design Parameters</i> table to correct typos.....	16

<b>Changes from Revision F (December 2016) to Revision G (January 2017)</b>	<b>Page</b>
• Changed <i>LMT90</i> to <i>LM50</i> in $V_O$ description of Equation 1 .....	15

<b>Changes from Revision E (September 2013) to Revision F (December 2016)</b>	<b>Page</b>
• Added <i>Device Information</i> table, <i>Pin Configuration and Functions</i> section, <i>ESD Ratings</i> table, <i>Detailed Description</i> section, <i>Application and Implementation</i> section, <i>Power Supply Recommendations</i> section, <i>Layout</i> section, <i>Device and Documentation Support</i> section, and <i>Mechanical, Packaging, and Orderable Information</i> section .....	1
• Deleted the <i>Temperature To Digital Converter (Parallel TRI-STATE Outputs for Standard Data Bus to <math>\mu P</math> Interface) (125°C Full Scale)</i> figure.....	19

<b>Changes from Revision C (February 2013) to Revision E (September 2013)</b>	<b>Page</b>
• Added LM50-Q1 option throughout document.....	1

## 11 Mechanical, Packaging, and Orderable Information

The following pages include mechanical, packaging, and orderable information. This information is the most current data available for the designated devices. This data is subject to change without notice and revision of this document. For browser-based versions of this data sheet, refer to the left-hand navigation.

**PACKAGING INFORMATION**

Orderable part number	Status (1)	Material type (2)	Package   Pins	Package qty   Carrier	RoHS (3)	Lead finish/ Ball material (4)	MSL rating/ Peak reflow (5)	Op temp (°C)	Part marking (6)
LM50BIM3	NRND	Production	SOT-23 (DBZ)   3	1000   LARGE T&R	No	SNPB	Level-1-260C-UNLIM	-40 to 150	T5B
LM50BIM3.B	NRND	Production	SOT-23 (DBZ)   3	1000   LARGE T&R	No	SNPB	Level-1-260C-UNLIM	-40 to 150	T5B
<a href="#">LM50BIM3/NOPB</a>	Obsolete	Production	SOT-23 (DBZ)   3	-	-	Call TI	Call TI	-40 to 125	T5B
<a href="#">LM50BIM3X/NOPB</a>	Active	Production	SOT-23 (DBZ)   3	3000   LARGE T&R	Yes	NIPDAU   SN	Level-1-260C-UNLIM	-40 to 125	T5B
LM50BIM3X/NOPB.A	Active	Production	SOT-23 (DBZ)   3	3000   LARGE T&R	Yes	NIPDAU	Level-1-260C-UNLIM	-40 to 125	T5B
LM50BIM3X/NOPB.B	Active	Production	SOT-23 (DBZ)   3	3000   LARGE T&R	Yes	NIPDAU	Level-1-260C-UNLIM	-40 to 125	T5B
<a href="#">LM50CIM3</a>	Active	Production	SOT-23 (DBZ)   3	1000   SMALL T&R	No	SNPB	Level-1-260C-UNLIM	-40 to 125	T5C
LM50CIM3.B	Active	Production	SOT-23 (DBZ)   3	1000   SMALL T&R	No	SNPB	Level-1-260C-UNLIM	-40 to 125	T5C
LM50CIM3X	NRND	Production	SOT-23 (DBZ)   3	3000   LARGE T&R	No	SNPB	Level-1-260C-UNLIM	-40 to 150	T5C
LM50CIM3X.B	NRND	Production	SOT-23 (DBZ)   3	3000   LARGE T&R	No	SNPB	Level-1-260C-UNLIM	-40 to 150	T5C
<a href="#">LM50CIM3X/NOPB</a>	Active	Production	SOT-23 (DBZ)   3	3000   LARGE T&R	Yes	NIPDAU   SN	Level-1-260C-UNLIM	-40 to 125	T5C
LM50CIM3X/NOPB.A	Active	Production	SOT-23 (DBZ)   3	3000   LARGE T&R	Yes	NIPDAU	Level-1-260C-UNLIM	-40 to 125	T5C
LM50CIM3X/NOPB.B	Active	Production	SOT-23 (DBZ)   3	3000   LARGE T&R	Yes	NIPDAU	Level-1-260C-UNLIM	-40 to 125	T5C
<a href="#">LM50HVDBZR</a>	Active	Production	SOT-23 (DBZ)   3	3000   LARGE T&R	Yes	NIPDAU	Level-1-260C-UNLIM	-40 to 150	T5H

(1) **Status:** For more details on status, see our [product life cycle](#).

(2) **Material type:** When designated, preproduction parts are prototypes/experimental devices, and are not yet approved or released for full production. Testing and final process, including without limitation quality assurance, reliability performance testing, and/or process qualification, may not yet be complete, and this item is subject to further changes or possible discontinuation. If available for ordering, purchases will be subject to an additional waiver at checkout, and are intended for early internal evaluation purposes only. These items are sold without warranties of any kind.

(3) **RoHS values:** Yes, No, RoHS Exempt. See the [TI RoHS Statement](#) for additional information and value definition.

(4) **Lead finish/Ball material:** Parts may have multiple material finish options. Finish options are separated by a vertical ruled line. Lead finish/Ball material values may wrap to two lines if the finish value exceeds the maximum column width.

(5) **MSL rating/Peak reflow:** The moisture sensitivity level ratings and peak solder (reflow) temperatures. In the event that a part has multiple moisture sensitivity ratings, only the lowest level per JEDEC standards is shown. Refer to the shipping label for the actual reflow temperature that will be used to mount the part to the printed circuit board.

(6) **Part marking:** There may be an additional marking, which relates to the logo, the lot trace code information, or the environmental category of the part.



Multiple part markings will be inside parentheses. Only one part marking contained in parentheses and separated by a "~" will appear on a part. If a line is indented then it is a continuation of the previous line and the two combined represent the entire part marking for that device.

**Important Information and Disclaimer:** The information provided on this page represents TI's knowledge and belief as of the date that it is provided. TI bases its knowledge and belief on information provided by third parties, and makes no representation or warranty as to the accuracy of such information. Efforts are underway to better integrate information from third parties. TI has taken and continues to take reasonable steps to provide representative and accurate information but may not have conducted destructive testing or chemical analysis on incoming materials and chemicals. TI and TI suppliers consider certain information to be proprietary, and thus CAS numbers and other limited information may not be available for release.

In no event shall TI's liability arising out of such information exceed the total purchase price of the TI part(s) at issue in this document sold by TI to Customer on an annual basis.

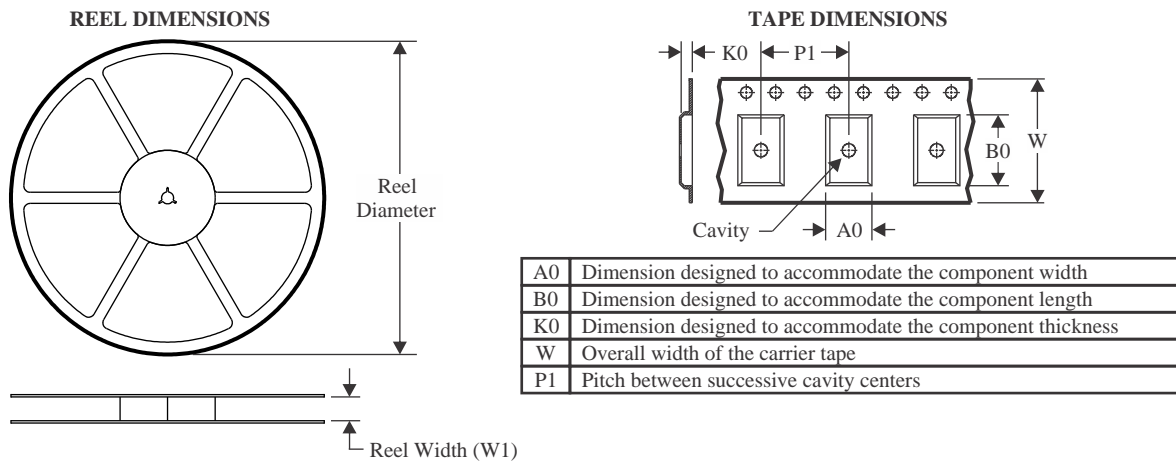
**OTHER QUALIFIED VERSIONS OF LM50 :**

- Automotive : [LM50-Q1](#)

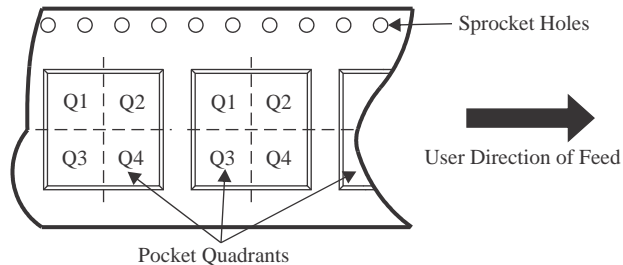
NOTE: Qualified Version Definitions:

- Automotive - Q100 devices qualified for high-reliability automotive applications targeting zero defects

## TAPE AND REEL INFORMATION



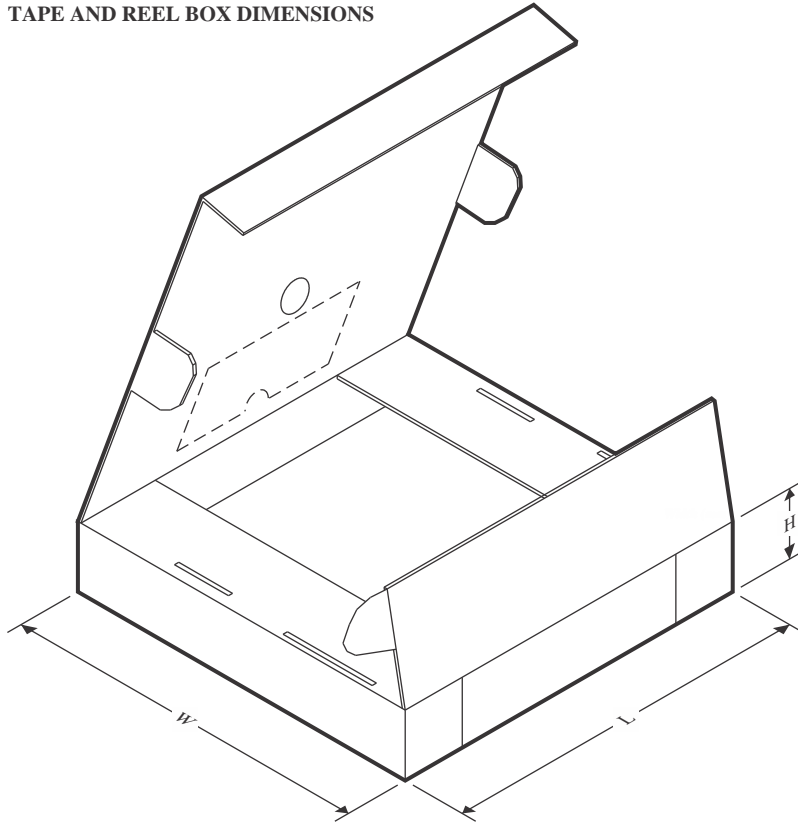
### QUADRANT ASSIGNMENTS FOR PIN 1 ORIENTATION IN TAPE



\*All dimensions are nominal

Device	Package Type	Package Drawing	Pins	SPQ	Reel Diameter (mm)	Reel Width W1 (mm)	A0 (mm)	B0 (mm)	K0 (mm)	P1 (mm)	W (mm)	Pin1 Quadrant
LM50BIM3X/NOPB	SOT-23	DBZ	3	3000	178.0	8.4	3.3	2.9	1.22	4.0	8.0	Q3
LM50CIM3X/NOPB	SOT-23	DBZ	3	3000	178.0	8.4	3.3	2.9	1.22	4.0	8.0	Q3
LM50HVDBZR	SOT-23	DBZ	3	3000	180.0	8.4	2.9	3.35	1.35	4.0	8.0	Q3

## TAPE AND REEL BOX DIMENSIONS



\*All dimensions are nominal

Device	Package Type	Package Drawing	Pins	SPQ	Length (mm)	Width (mm)	Height (mm)
LM50BIM3X/NOPB	SOT-23	DBZ	3	3000	208.0	191.0	35.0
LM50CIM3X/NOPB	SOT-23	DBZ	3	3000	208.0	191.0	35.0
LM50HVDBZR	SOT-23	DBZ	3	3000	210.0	185.0	35.0

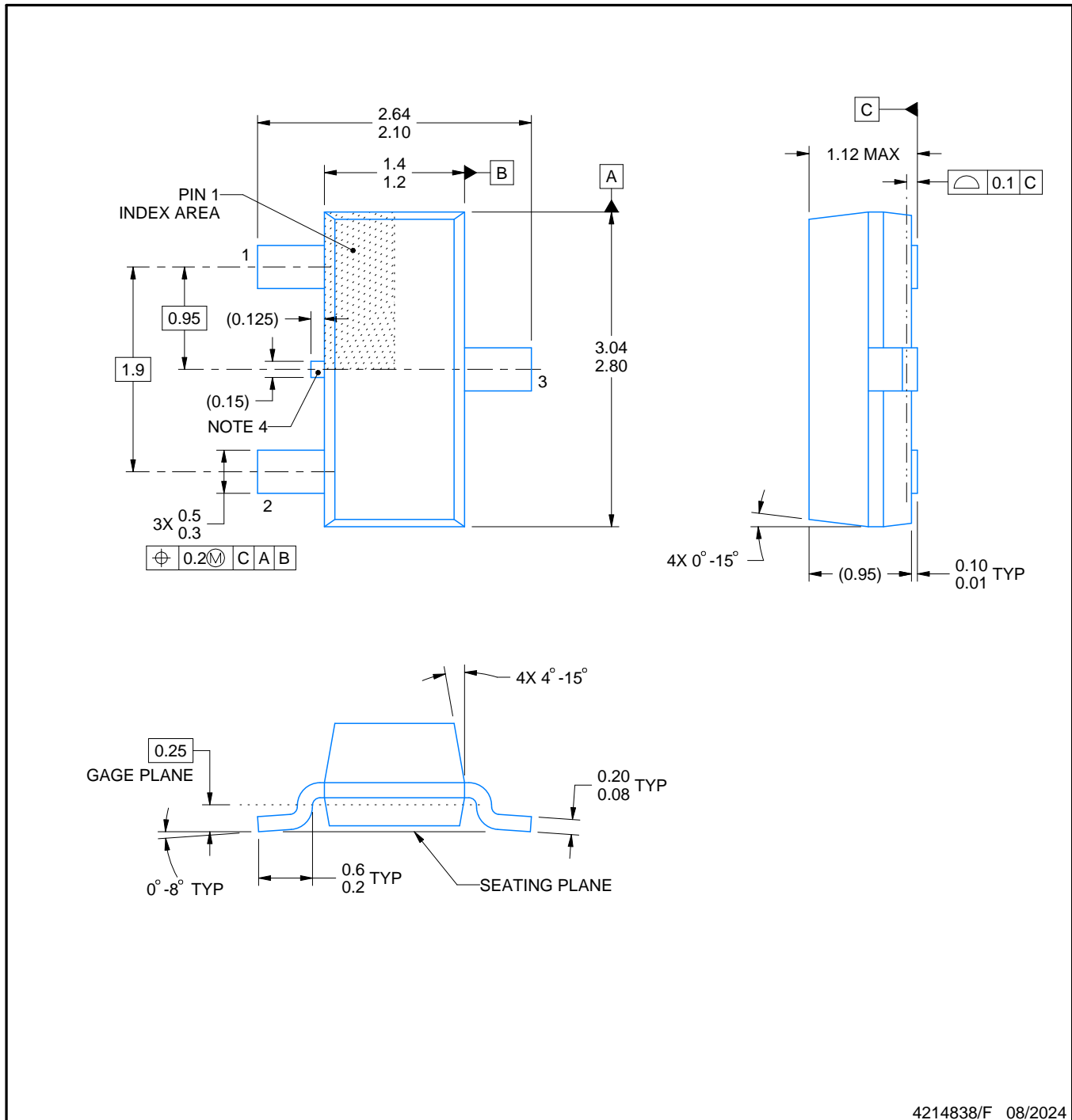


## DBZ0003A

## PACKAGE OUTLINE

SOT-23 - 1.12 mm max height

SMALL OUTLINE TRANSISTOR



4214838/F 08/2024

## NOTES:

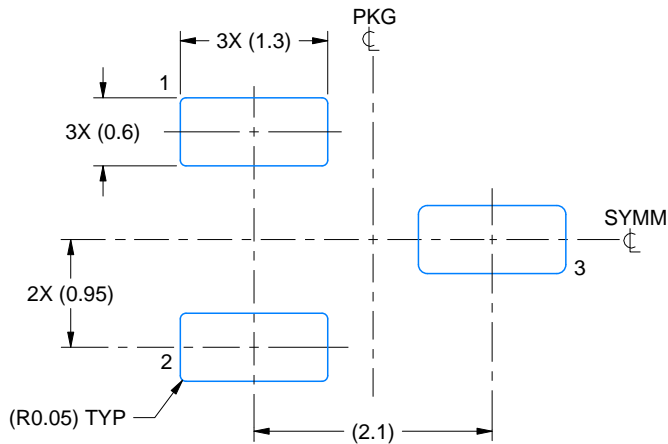
- All linear dimensions are in millimeters. Any dimensions in parenthesis are for reference only. Dimensioning and tolerancing per ASME Y14.5M.
- This drawing is subject to change without notice.
- Reference JEDEC registration TO-236, except minimum foot length.
- Support pin may differ or may not be present.
- Body dimensions do not include mold flash, protrusions, or gate burrs. Mold flash, protrusions, or gate burrs shall not exceed 0.25mm per side

# EXAMPLE BOARD LAYOUT

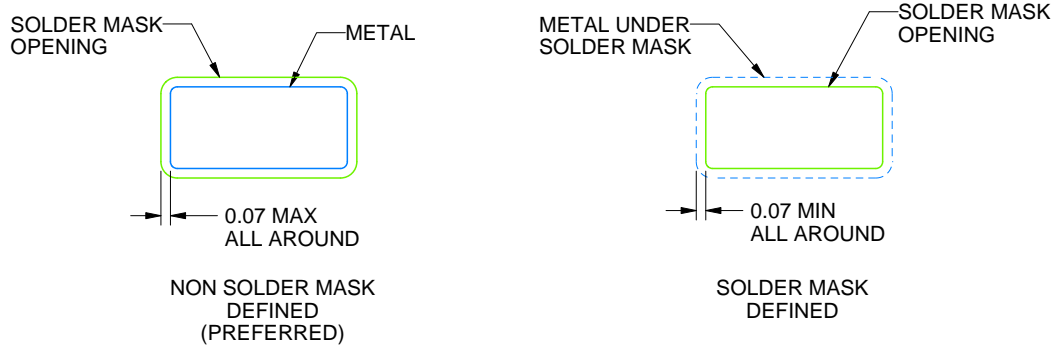
**DBZ0003A**

**SOT-23 - 1.12 mm max height**

SMALL OUTLINE TRANSISTOR



LAND PATTERN EXAMPLE  
SCALE:15X



SOLDER MASK DETAILS

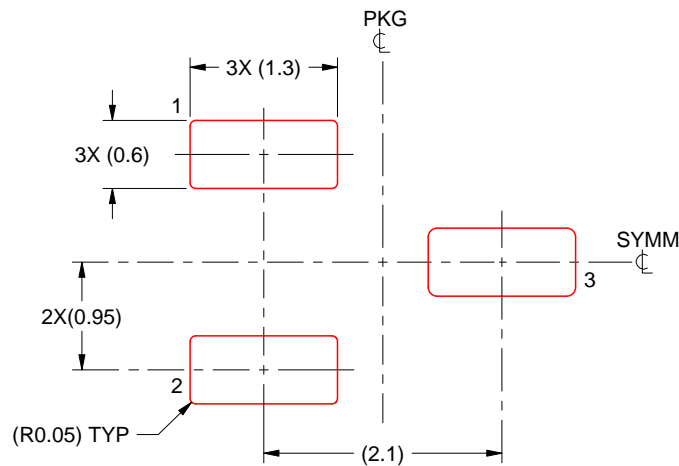
4214838/F 08/2024

NOTES: (continued)

- 5. Publication IPC-7351 may have alternate designs.
- 6. Solder mask tolerances between and around signal pads can vary based on board fabrication site.

**EXAMPLE STENCIL DESIGN****DBZ0003A****SOT-23 - 1.12 mm max height**

SMALL OUTLINE TRANSISTOR



SOLDER PASTE EXAMPLE  
 BASED ON 0.125 THICK STENCIL  
 SCALE:15X

4214838/F 08/2024

NOTES: (continued)

7. Laser cutting apertures with trapezoidal walls and rounded corners may offer better paste release. IPC-7525 may have alternate design recommendations.
8. Board assembly site may have different recommendations for stencil design.

## IMPORTANT NOTICE AND DISCLAIMER

TI PROVIDES TECHNICAL AND RELIABILITY DATA (INCLUDING DATASHEETS), DESIGN RESOURCES (INCLUDING REFERENCE DESIGNS), APPLICATION OR OTHER DESIGN ADVICE, WEB TOOLS, SAFETY INFORMATION, AND OTHER RESOURCES "AS IS" AND WITH ALL FAULTS, AND DISCLAIMS ALL WARRANTIES, EXPRESS AND IMPLIED, INCLUDING WITHOUT LIMITATION ANY IMPLIED WARRANTIES OF MERCHANTABILITY, FITNESS FOR A PARTICULAR PURPOSE OR NON-INFRINGEMENT OF THIRD PARTY INTELLECTUAL PROPERTY RIGHTS.

These resources are intended for skilled developers designing with TI products. You are solely responsible for (1) selecting the appropriate TI products for your application, (2) designing, validating and testing your application, and (3) ensuring your application meets applicable standards, and any other safety, security, regulatory or other requirements.

These resources are subject to change without notice. TI grants you permission to use these resources only for development of an application that uses the TI products described in the resource. Other reproduction and display of these resources is prohibited. No license is granted to any other TI intellectual property right or to any third party intellectual property right. TI disclaims responsibility for, and you fully indemnify TI and its representatives against any claims, damages, costs, losses, and liabilities arising out of your use of these resources.

TI's products are provided subject to [TI's Terms of Sale](#), [TI's General Quality Guidelines](#), or other applicable terms available either on [ti.com](http://ti.com) or provided in conjunction with such TI products. TI's provision of these resources does not expand or otherwise alter TI's applicable warranties or warranty disclaimers for TI products. Unless TI explicitly designates a product as custom or customer-specified, TI products are standard, catalog, general purpose devices.

TI objects to and rejects any additional or different terms you may propose.

Copyright © 2026, Texas Instruments Incorporated

Last updated 10/2025

## OUR CERTIFICATE

DiGi provide top-quality products and perfect service for customer worldwide through standardization, technological innovation and continuous improvement. DiGi through third-party certification, we strictly control the quality of products and services. Welcome your RFQ to

Email: [Info@DiGi-Electronics.com](mailto:Info@DiGi-Electronics.com)



Tel: +00 852-30501935

RFQ Email: [Info@DiGi-Electronics.com](mailto:Info@DiGi-Electronics.com)

DiGi is a global authorized distributor of electronic components.