

LMK61A2-156M25SIAT Datasheet

www.digi-electronics.com

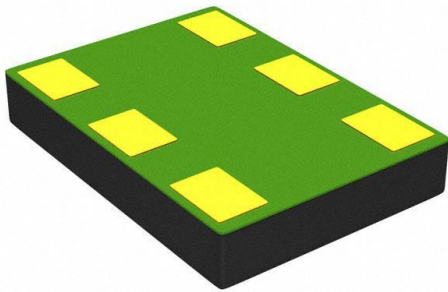

LMK61A2-156M25SIAT

<https://www.DiGi-Electronics.com>

DiGi Electronics Part Number	LMK61A2-156M25SIAT-DG
Manufacturer	Texas Instruments
Manufacturer Product Number	LMK61A2-156M25SIAT
Description	IC OSC CLK 156.25MHZ 6QFM
Detailed Description	Clock Oscillator IC 156.25MHz 6-QFM (7x5)



Tel: +00 852-30501935

RFQ Email: Info@DiGi-Electronics.com

DiGi is a global authorized distributor of electronic components.

Purchase and inquiry

Manufacturer Product Number:

LMK61A2-156M25SIAT

Series:

-

Type:

Clock Oscillator

Frequency:

156.25MHz

Current - Supply:

152 mA

Package / Case:

6-SMD Module

Mounting Type:

Surface Mount

Manufacturer:

Texas Instruments

Product Status:

Active

Count:

-

Voltage - Supply:

3.135V ~ 3.465V

Operating Temperature:

-40°C ~ 85°C

Supplier Device Package:

6-QFM (7x5)

Base Product Number:

LMK61A2

Environmental & Export classification

RoHS Status:

ROHS3 Compliant

REACH Status:

REACH Unaffected

HTSUS:

8542.39.0001

Moisture Sensitivity Level (MSL):

3 (168 Hours)

ECCN:

EAR99

LMK61XX High-Performance Ultra-Low Jitter Oscillator

1 Features

- Ultra-low Noise, High Performance
 - Jitter: 90 fs RMS Typical Fout > 100 MHz
 - PSRR: –70 dBc, Robust Supply Noise Immunity
- Supported Output Format
 - LVPECL up to 1 GHz
 - LVDS up to 900 MHz
 - HCSL up to 400 MHz
- Total Frequency Tolerance of ± 50 ppm (LMK61X2) and ± 25 ppm (LMK61X0)
- 3.3-V Operating Voltage
- Industrial Temperature Range (–40°C to +85°C)
- 7 mm × 5 mm 6-Pin Package, Pin-Compatible With Industry Standard 7050 XO Package

2 Applications

- High-Performance Replacement for Crystal, SAW, or Silicon-Based Oscillators
- Switches, Routers, Network Line Cards, Base Band Units (BBU), Servers, Storage/SAN
- Test and Measurement
- Medical Imaging
- FPGA, Processor Attach

3 Description

The LMK61XX is an ultra-low jitter oscillator that generates a commonly used reference clock. The device is pre-programmed in factory to support any reference clock frequency; supported output formats are LVPECL up to 1 GHz, LVDS up to 900 MHz, and HCSL up to 400 MHz. Internal power conditioning provide excellent power supply ripple rejection (PSRR), reducing the cost and complexity of the power delivery network. The device operates from a single 3.3 V ± 5% supply.

Device Information⁽¹⁾

PART NUMBER	OUTPUT FREQ (MHz) AND FORMAT	TOTAL FREQ STABILITY (PPM)	PACKAGE
LMK61A2-100M00	100 LVDS	± 50	6-pin QFM (7.0 mm x 5.0 mm)
LMK61A2-125M00	125 LVDS	± 50	
LMK61A2-156M25	156.25 LVDS	± 50	
LMK61A2-312M50	312.5 LVDS	± 50	
LMK61A2-644M53	644.53125 LVDS	± 50	
LMK61E0-050M00	50 LVPECL	± 25	
LMK61E0-155M52	155.52 LVPECL	± 25	
LMK61E0-156M25	156.25 LVPECL	± 25	
LMK61E2-100M00	100 LVPECL	± 50	
LMK61E2-125M00	125 LVPECL	± 50	
LMK61E2-156M25	156.25 LVPECL	± 50	
LMK61E2-312M50	312.5 LVPECL	± 50	
LMK61I2-100M00	100 HCSL	± 50	

(1) For all available packages, see the orderable addendum at the end of the data sheet.

Pinout

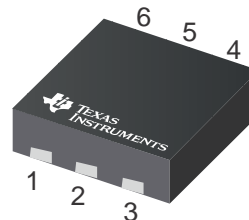
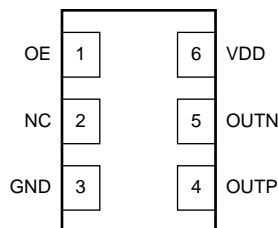

Table of Contents

1 Features	1	6.13 PLL Clock Output Jitter Characteristics	7
2 Applications	1	6.14 Typical 156.25-MHz Output Phase Noise Characteristics	7
3 Description	1	6.15 Additional Reliability and Qualification	7
4 Revision History	2	6.16 Typical Characteristics	8
5 Pin Configuration and Functions	3	7 Parameter Measurement Information	10
6 Specifications	4	7.1 Device Output Configurations	10
6.1 Absolute Maximum Ratings	4	8 Power Supply Recommendations	12
6.2 ESD Ratings	4	9 Layout	12
6.3 Recommended Operating Conditions	4	9.1 Layout Guidelines	12
6.4 Thermal Information	4	10 Device and Documentation Support	14
6.5 Electrical Characteristics - Power Supply	5	10.1 Related Links	14
6.6 LVPECL Output Characteristics	5	10.2 Receiving Notification of Documentation Updates	14
6.7 LVDS Output Characteristics	5	10.3 Community Resources	14
6.8 HCSL Output Characteristics	6	10.4 Trademarks	14
6.9 OE Input Characteristics	6	10.5 Electrostatic Discharge Caution	14
6.10 Frequency Tolerance Characteristics	6	10.6 Glossary	14
6.11 Power-On/Reset Characteristics (VDD)	6	11 Mechanical, Packaging, and Orderable Information	15
6.12 PSRR Characteristics	7		

4 Revision History

NOTE: Page numbers for previous revisions may differ from page numbers in the current version.

Changes from Revision C (September 2017) to Revision D	Page
• Added LMK61A2-644M	1
• Added LMK61E0-156M	1

Changes from Revision B (March 2017) to Revision C	Page
• Added LMK61E0-155M	1

Changes from Revision A (November 2015) to Revision B	Page
• Updated data sheet text to the latest documentation and translations standards	1
• Added LMK61E0-050M	1
• Updated key graphic	1
• Added <i>Receiving Notification of Documentation Updates</i> section	14

Changes from Original (October 2015) to Revision A	Page
• Product Preview to Production Data Datasheet	1

5 Pin Configuration and Functions

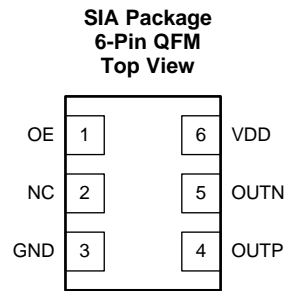

Pin Functions

PIN		I/O	DESCRIPTION
NAME	NO.		
POWER			
GND	3	Ground	Device Ground.
VDD	6	Analog	3.3 V Power Supply.
OUTPUT BLOCK			
OUTP, OUTN	4, 5	Universal	Differential Output Pair (LVPECL, LVDS or HCSL).
DIGITAL CONTROL / INTERFACES			
NC	2	N/A	No Connect.
OE	1	LVC MOS	Output Enable (internal pullup). When set to low, output pair is disabled and set at high impedance.

6 Specifications

6.1 Absolute Maximum Ratings

over operating free-air temperature range (unless otherwise noted)⁽¹⁾

		MIN	MAX	UNIT
V _{DD}	Device supply voltage	-0.3	3.6	V
V _{IN}	Output voltage for logic inputs	-0.3	V _{DD} + 0.3	V
V _{OUT}	Output voltage for clock outputs	-0.3	V _{DD} + 0.3	V
T _J	Junction temperature		150	°C
T _{STG}	Storage temperature	-40	125	°C

- (1) Stresses beyond those listed under *Absolute Maximum Ratings* may cause permanent damage to the device. These are stress ratings only, which do not imply functional operation of the device at these or any other conditions beyond those indicated under *Recommended Operating Conditions*. Exposure to absolute maximum-rated conditions for extended periods may affect device reliability.

6.2 ESD Ratings

		VALUE	UNIT
V _(ESD)	Electrostatic discharge	Human-body model (HBM), per ANSI/ESDA/JEDEC JS-001 ⁽¹⁾	±4000
		Charged-device model (CDM), per JEDEC specification JESD22-C101 ⁽²⁾	±1500

- (1) JEDEC document JEP155 states that 500 V HBM allows safe manufacturing with a standard ESD control process.

- (2) JEDEC document JEP157 states that 250 V CDM allows safe manufacturing with a standard ESD control process.

6.3 Recommended Operating Conditions

over operating free-air temperature range (unless otherwise noted)

		MIN	NOM	MAX	UNIT
V _{DD}	Device supply voltage	3.135	3.3	3.465	V
T _A	Ambient temperature	-40	25	85	°C
T _J	Junction temperature	LMK61X2		125	°C
		LMK61X0		115	°C
t _{RAMP}	V _{DD} power-up ramp time	0.1		100	ms

6.4 Thermal Information

THERMAL METRIC ⁽¹⁾	LMK61XX ^{(2) (3) (4)}			UNIT	
	SIA (QFM)				
	6 PINS				
	Airflow (LFM) 0	Airflow (LFM) 200	Airflow (LFM) 400		
R _{θJA}	Junction-to-ambient thermal resistance	55.2	46.4	43.7	°C/W
R _{θJC(top)}	Junction-to-case (top) thermal resistance	34.6	n/a	n/a	°C/W
R _{θJB}	Junction-to-board thermal resistance	37.7	n/a	n/a	°C/W
ψ _{JT}	Junction-to-top characterization parameter	11.3	17.6	22.5	°C/W
ψ _{JB}	Junction-to-board characterization parameter	37.7	41.5	40.1	°C/W
R _{θJC(bot)}	Junction-to-case (bottom) thermal resistance	n/a	n/a	n/a	°C/W

- (1) For more information about traditional and new thermal metrics, see the [Semiconductor and IC Package Thermal Metrics](#) application report.
- (2) The package thermal resistance is calculated on a 4 layer JEDEC board.
- (3) Connected to GND with 3 thermal vias (0.3-mm diameter).
- (4) ψ_{JB} (junction to board) is used when the main heat flow is from the junction to the GND pad. Please refer to Thermal Considerations section for more information on ensuring good system reliability and quality.

6.5 Electrical Characteristics - Power Supply⁽¹⁾

VDD = 3.3 V ± 5%, T_A = -40°C to 85°C

PARAMETER		TEST CONDITIONS	MIN	TYP	MAX	UNIT
IDD	Device current consumption	LVPECL ⁽²⁾		162	208	mA
		LVDS		152	196	
		HCSL		155	196	
IDD-PD	Device current consumption when output is disabled	OE = GND		136		mA

(1) Refer to Parameter Measurement Information for relevant test conditions.

(2) On-chip power dissipation should exclude 40 mW, dissipated in the 150 ohm termination resistors, from total power dissipation.

6.6 LVPECL Output Characteristics⁽¹⁾

VDD = 3.3 V ± 5%, T_A = -40°C to 85°C

PARAMETER		TEST CONDITIONS	MIN	TYP	MAX	UNIT
f _{OUT}	Output frequency ⁽²⁾		10		1000	MHz
V _{OD}	Output voltage swing (V _{OH} - V _{OL}) ⁽²⁾		700	800	1200	mV
V _{OUT, DIFF, PP}	Differential output peak-to-peak swing			2 × V _{OD}		V
V _{OS}	Output common-mode voltage			VDD - 1.55		V
t _R / t _F	Output rise/fall time (20% to 80%) ⁽³⁾			120	200	ps
PN-Floor	Output phase noise floor (f _{OFFSET} > 10 MHz)	156.25 MHz		-165		dBc/Hz
ODC	Output duty cycle ⁽³⁾		45%		55%	

(1) Refer to Parameter Measurement Information for relevant test conditions.

(2) An output frequency over f_{OUT} max spec is possible, but output swing may be less than V_{OD} min spec.

(3) Ensured by characterization.

6.7 LVDS Output Characteristics⁽¹⁾

VDD = 3.3 V ± 5%, T_A = -40°C to 85°C

PARAMETER		TEST CONDITIONS	MIN	TYP	MAX	UNIT
f _{OUT}	Output frequency ⁽¹⁾		10		900	MHz
V _{OD}	Output voltage swing (V _{OH} - V _{OL}) ⁽¹⁾		300	390	480	mV
V _{OUT, DIFF, PP}	Differential output peak-to-peak swing			2 × V _{OD}		V
V _{OS}	Output common-mode voltage			1.2		V
t _R / t _F	Output rise/fall time (20% to 80%) ⁽²⁾			150	250	ps
PN-Floor	Output phase noise floor (f _{OFFSET} > 10 MHz)	156.25 MHz		-162		dBc/Hz
ODC	Output duty cycle ⁽²⁾		45%		55%	
R _{OUT}	Differential output impedance			125		Ohm

(1) An output frequency over f_{OUT} max spec is possible, but output swing may be less than V_{OD} min spec.

(2) Ensured by characterization.

6.8 HCSL Output Characteristics⁽¹⁾

VDD = 3.3 V ± 5%, T_A = -40°C to 85°C

PARAMETER	TEST CONDITIONS	MIN	TYP	MAX	UNIT
f _{OUT}	Output frequency	10		400	MHz
V _{OH}	Output high voltage	600		850	mV
V _{OL}	Output low voltage	-100		100	mV
V _{CROSS}	Absolute crossing voltage ⁽²⁾⁽³⁾	250		475	mV
V _{CROSS-DELTA}	Variation of V _{CROSS} ⁽²⁾⁽³⁾	0		140	mV
dV/dt	Slew rate ⁽⁴⁾	0.8		2	V/ns
PN-Floor	Output phase noise floor (f _{OFFSET} > 10 MHz)	100 MHz		-164	dBc/Hz
ODC	Output duty cycle ⁽⁴⁾	45%		55%	

(1) Refer to Parameter Measurement Information for relevant test conditions.

(2) Measured from -150 mV to +150 mV on the differential waveform with the 300 mVpp measurement window centered on the differential zero crossing.

(3) Ensured by design.

(4) Ensured by characterization.

6.9 OE Input Characteristics

VDD = 3.3 V ± 5%, T_A = -40°C to 85°C

PARAMETER	TEST CONDITIONS	MIN	TYP	MAX	UNIT
V _{IH}	Input high voltage	1.4			V
V _{IL}	Input low voltage			0.6	V
I _{IH}	Input high current	V _{IH} = VDD		40	uA
I _{IL}	Input low current	V _{IL} = GND		40	uA
C _{IN}	Input capacitance		2		pF

6.10 Frequency Tolerance Characteristics⁽¹⁾

VDD = 3.3 V ± 5%, T_A = -40°C to 85°C

PARAMETER	TEST CONDITIONS	MIN	TYP	MAX	UNIT
f _T	LMK61X2: All output formats, frequency bands and device junction temperature up to 125°C; includes initial freq tolerance, temperature & supply voltage variation, solder reflow and aging (10 years)	-50		50	ppm
	LMK61X0: All output formats, frequency bands and device junction temperature up to 115°C; includes initial freq tolerance, temperature & supply voltage variation, solder reflow and aging (5 years at 40°C)	-25		25	ppm

(1) Ensured by characterization.

6.11 Power-On/Reset Characteristics (VDD)

VDD = 3.3 V ± 5%, T_A = -40°C to 85°C

PARAMETER	TEST CONDITIONS	MIN	TYP	MAX	UNIT
V _{THRESH}	Threshold voltage ⁽¹⁾	2.72		2.95	V
V _{DROOP}	Allowable voltage droop ⁽²⁾			0.1	V
t _{STARTUP}	Start-up time ⁽¹⁾	Time elapsed from VDD at 3.135 V to output enabled		10	ms
t _{OE-EN}	Output enable time ⁽²⁾	Time elapsed from OE at V _{IH} to output enabled		50	us
t _{OE-DIS}	Output disable time ⁽²⁾	Time elapsed from OE at V _{IL} to output disabled		50	us

(1) Ensured by characterization.

(2) Ensured by design.

6.12 PSRR Characteristics⁽¹⁾

 VDD = 3.3 V, T_A = 25°C, FS[1:0] = NC, NC

PARAMETER		TEST CONDITIONS	MIN	TYP	MAX	UNIT
PSRR	Spurs induced by 50-mV power supply ripple ⁽²⁾⁽³⁾ at 156.25-MHz output, all output types	Sine wave at 50 kHz		-70		dBc
		Sine wave at 100 kHz		-70		
		Sine wave at 500 kHz		-70		
		Sine wave at 1 MHz		-70		

(1) Refer to Parameter Measurement Information for relevant test conditions.

(2) Measured max spur level with 50 mVpp sinusoidal signal between 50 kHz and 1 MHz applied on VDD pin

 (3) $DJ_{SPUR} (ps, pk-pk) = [2 \cdot 10 \cdot (SPUR/20) / (\pi \cdot f_{OUT})] \cdot 1e6$, where PSRR or SPUR in dBc and f_{OUT} in MHz.

6.13 PLL Clock Output Jitter Characteristics⁽¹⁾⁽²⁾

 VDD = 3.3 V ± 5%, T_A = -40°C to 85°C

PARAMETER		TEST CONDITIONS	MIN	TYP	MAX	UNIT
RJ	RMS phase jitter ⁽³⁾ (12 kHz – 20 MHz) (1 kHz – 5 MHz)	f _{OUT} < 100 MHz, all output types		200	300	fs RMS
RJ	RMS phase jitter ⁽³⁾ (12 kHz – 20 MHz) (1 kHz – 5 MHz)	f _{OUT} ≥ 100 MHz (except 155.52 MHz and 644.53125 MHz), all output types		100	200	fs RMS
RJ	RMS phase jitter ⁽³⁾ (12 kHz – 20 MHz) (1 kHz – 5 MHz)	f _{OUT} = 155.52 MHz or 644.53125 MHz, all output types		150	300	fs RMS

(1) Refer to Parameter Measurement Information for relevant test conditions.

(2) Phase jitter measured with Agilent E5052 signal source analyzer using a differential-to-single ended converter (balun or buffer).

(3) Ensured by characterization.

6.14 Typical 156.25-MHz Output Phase Noise Characteristics⁽¹⁾⁽²⁾

 VDD = 3.3 V, T_A = 25°C, Output Type = LVPECL/LVDS/HCSL

PARAMETER		OUTPUT TYPE			UNITS
		LVPECL	LVDS	HCSL	
phn _{10k}	Phase noise at 10-kHz offset	-143	-143	-143	dBc/Hz
Phn _{20k}	Phase noise at 20-kHz offset	-143	-143	-143	dBc/Hz
phn _{100k}	Phase noise at 100-kHz offset	-144	-144	-144	dBc/Hz
Phn _{200k}	Phase noise at 200-kHz offset	-145	-145	-145	dBc/Hz
phn _{1M}	Phase noise at 1-MHz offset	-150	-150	-150	dBc/Hz
phn _{2M}	Phase noise at 2-MHz offset	-154	-154	-154	dBc/Hz
phn _{10M}	Phase noise at 10-MHz offset	-165	-162	-164	dBc/Hz
phn _{20M}	Phase noise at 20-MHz offset	-165	-162	-164	dBc/Hz

(1) Refer to Parameter Measurement Information for relevant test conditions.

(2) Phase jitter measured with Agilent E5052 signal source analyzer using a differential-to-single ended converter (balun or buffer).

6.15 Additional Reliability and Qualification

PARAMETER	CONDITION / TEST METHOD
Mechanical Shock	MIL-STD-202, Method 213
Mechanical Vibration	MIL-STD-202, Method 204
Moisture Sensitivity Level	J-STD-020, MSL3

6.16 Typical Characteristics

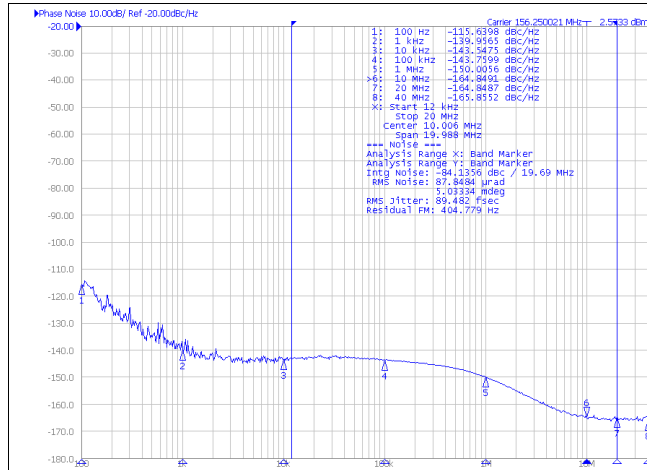

Figure 1. Phase Noise of 156.25-MHz LVPECL Differential Output

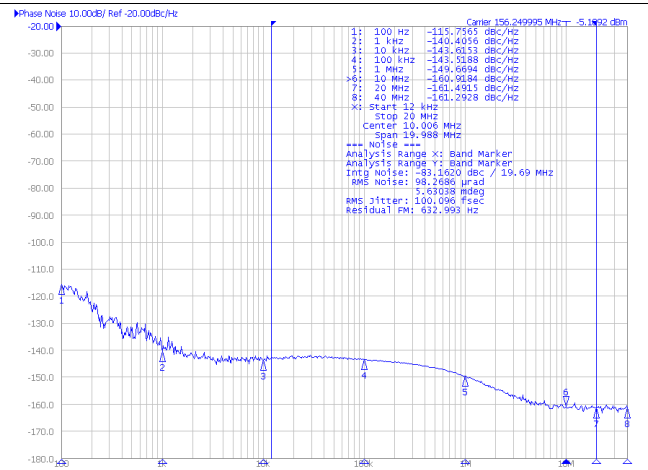

Figure 2. Phase Noise of 156.25-MHz LVDS Differential Output

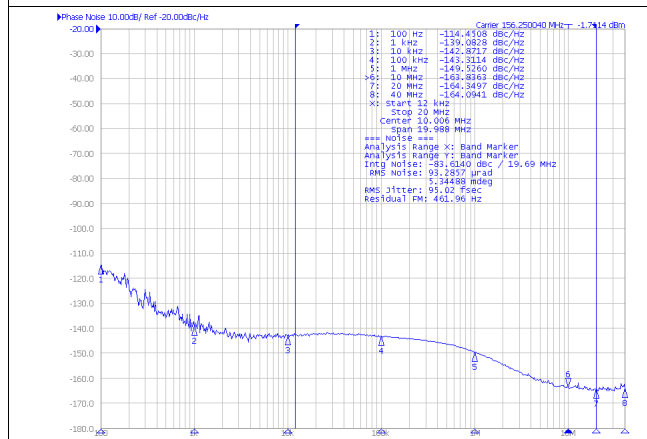

Figure 3. Phase Noise of 156.25-MHz HCSL Differential Output

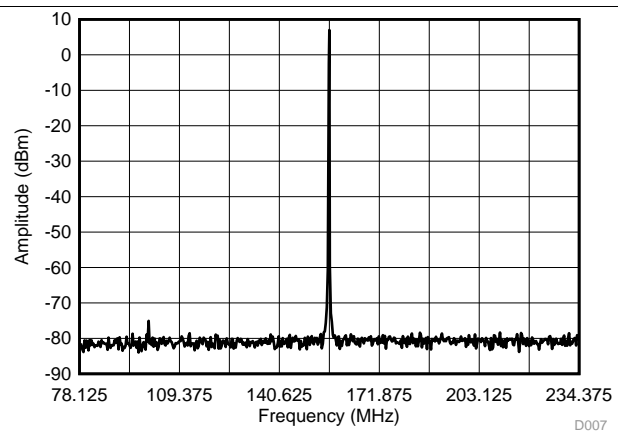

Figure 4. 156.25 ± 78.125-MHz LVPECL Differential Output Spectrum

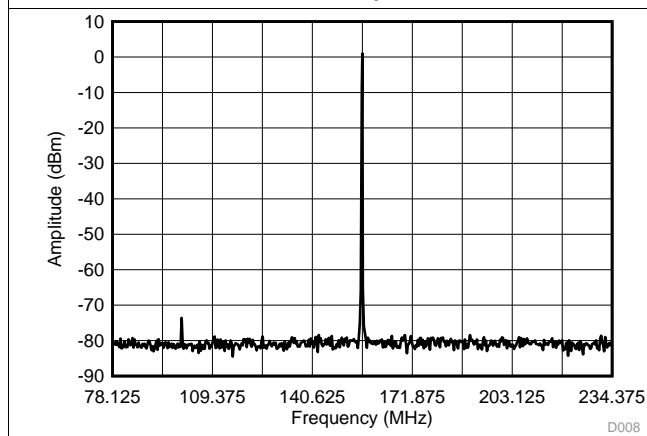

Figure 5. 156.25 ± 78.125-MHz LVDS Differential Output Spectrum

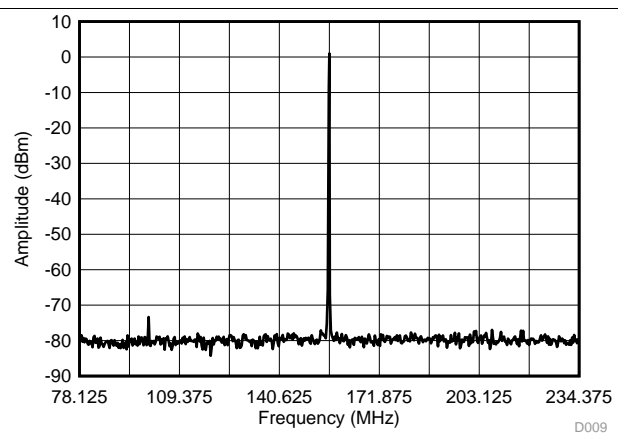

Figure 6. 156.25 ± 78.125-MHz HCSL Differential Output Spectrum

Typical Characteristics (continued)

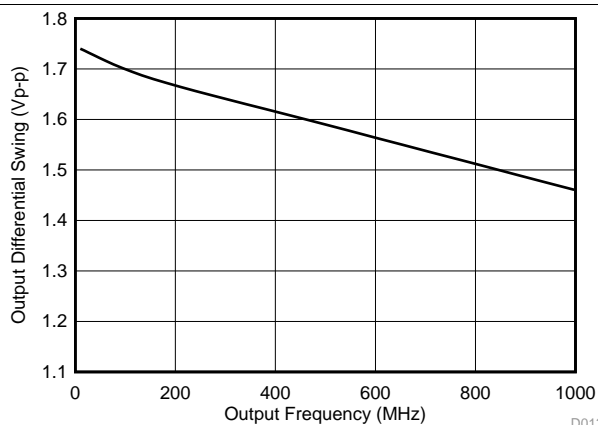

Figure 7. LVPECL Differential Output Swing vs Frequency

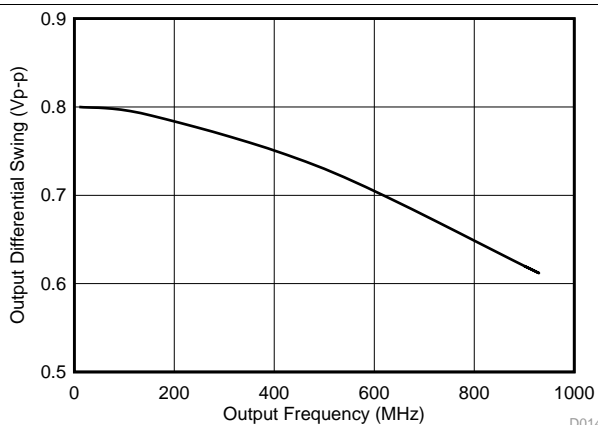

Figure 8. LVDS Differential Output Swing vs Frequency

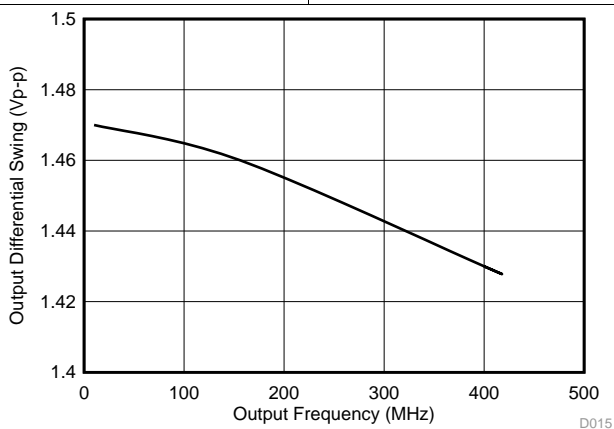

Figure 9. HCSL Differential Output Swing vs Frequency

7 Parameter Measurement Information

7.1 Device Output Configurations

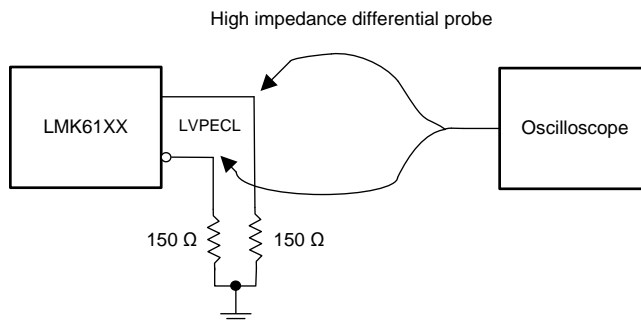

Figure 10. LVPECL Output DC Configuration During Device Test

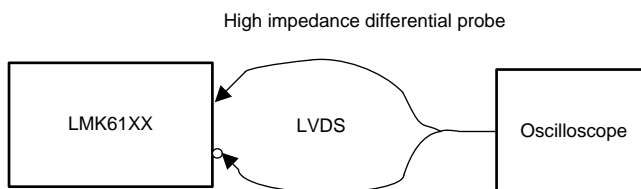

Figure 11. LVDS Output DC Configuration During Device Test

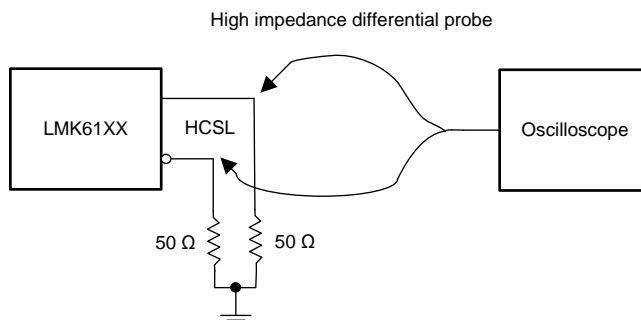

Figure 12. HCSL Output DC Configuration During Device Test

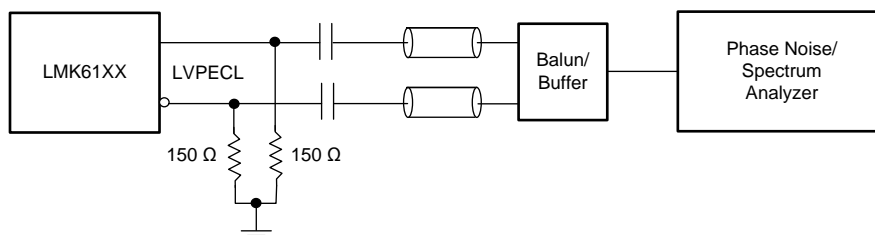

Figure 13. LVPECL Output AC Configuration During Device Test

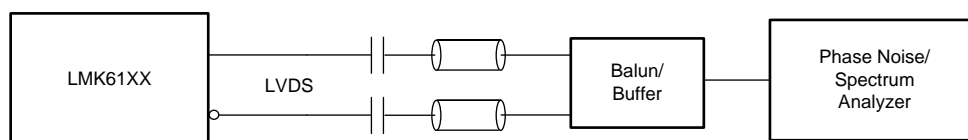

Figure 14. LVDS Output AC Configuration During Device Test

Device Output Configurations (continued)

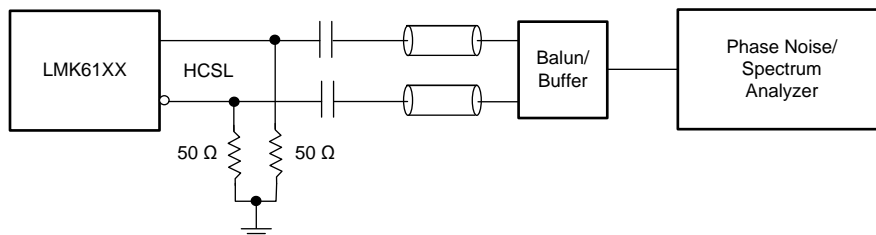

Figure 15. HCSL Output AC Configuration During Device Test

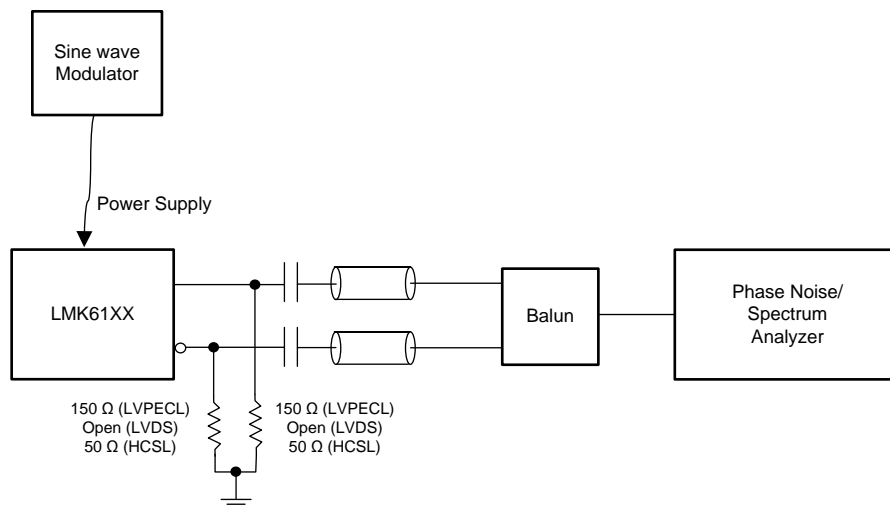

Figure 16. PSRR Test Setup

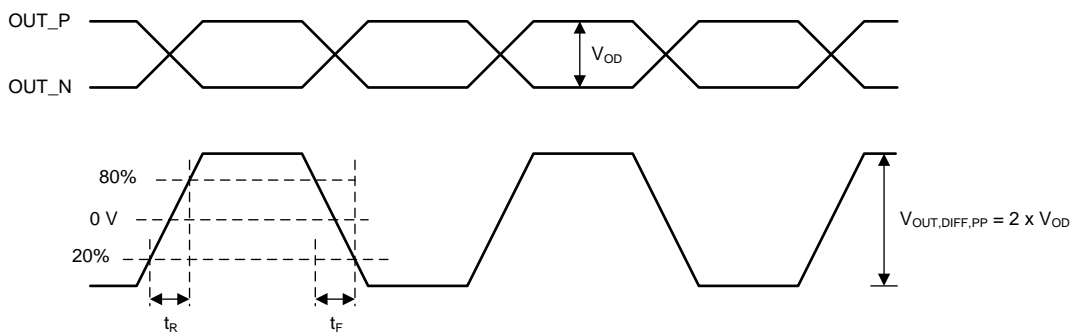

Figure 17. Differential Output Voltage and Rise/Fall Time

8 Power Supply Recommendations

For best electrical performance of LMK61XX, TI recommends using a combination of 10 μF , 1 μF and 0.1 μF on its power supply bypass network. TI also recommends using component side mounting of the power supply bypass capacitors and it is best to use 0201 or 0402 body size capacitors to facilitate signal routing. Keep the connections between the bypass capacitors and the power supply on the device as short as possible. Ground the other side of the capacitor using a low impedance connection to the ground plane. [Figure 18](#) shows the layout recommendation for power supply decoupling of LMK61XX.

9 Layout

9.1 Layout Guidelines

The following sections provides recommendations for board layout, solder reflow profile and power supply bypassing when using LMK61XX to ensure good thermal / electrical performance and overall signal integrity of entire system.

9.1.1 Ensuring Thermal Reliability

The LMK61XX is a high performance device. Therefore, pay careful attention to device configuration and printed-circuit board (PCB) layout with respect to power consumption. The ground pin needs to be connected to the ground plane of the PCB through three vias or more, as shown in [Figure 18](#), to maximize thermal dissipation out of the package.

[Equation 1](#) describes the relationship between the PCB temperature around the LMK61XX and its junction temperature.

$$T_B = T_J - \Psi_{JB} \times P$$

where

- T_B : PCB temperature around the LMK61XX
 - T_J : Junction temperature of LMK61XX
 - Ψ_{JB} : Junction-to-board thermal resistance parameter of LMK61XX (37.7°C/W without airflow)
 - P : On-chip power dissipation of LMK61XX
- (1)

To ensure that the maximum junction temperature of LMK61X2 is below 125°C, the maximum PCB temperature without airflow should be at 99°C or below (89°C or below for LMK61X0) when the device is optimized for best performance resulting in maximum on-chip power dissipation of 0.68 W.

9.1.2 Best Practices for Signal Integrity

For best electrical performance and signal integrity of entire system with LMK61XX, TI recommends routing vias into decoupling capacitors and then into the LMK61XX. TI also recommends increasing the via count and width of the traces wherever possible. These steps ensure lowest impedance and shortest path for high frequency current flow. [Figure 18](#) shows the layout recommendation for LMK61XX.

Layout Guidelines (continued)

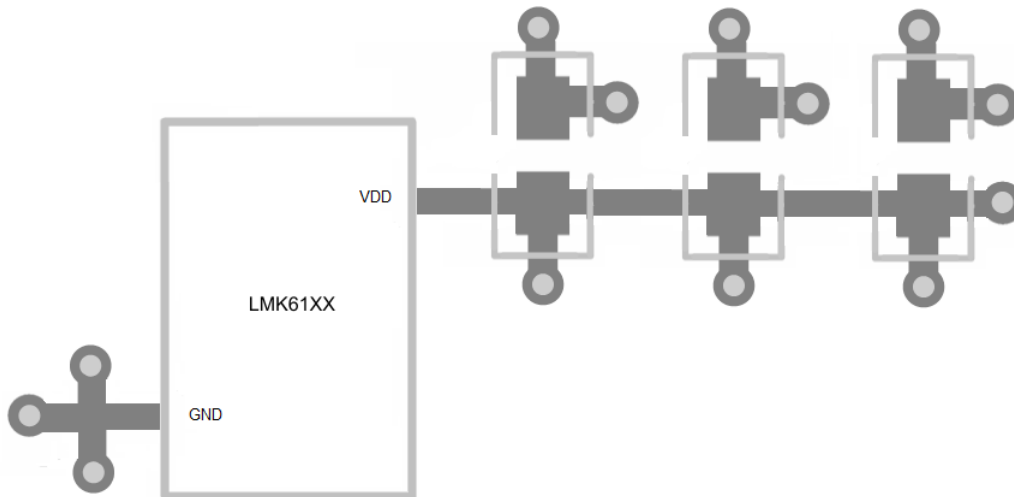

Figure 18. LMK61XX Layout Recommendation for Power Supply and Ground

9.1.3 Recommended Solder Reflow Profile

TI recommends following the solder paste supplier's recommendations to optimize flux activity and to achieve proper melting temperatures of the alloy within the guidelines of J-STD-20. It is preferable for the LMK61XX to be processed with the lowest peak temperature possible while also remaining below the components peak temperature rating as listed on the MSL label. The exact temperature profile would depend on several factors including maximum peak temperature for the component as rated on the MSL label, Board thickness, PCB material type, PCB geometries, component locations, sizes, densities within PCB, as well solder manufactures recommended profile, and capability of the reflow equipment to as confirmed by the SMT assembly operation.

10 Device and Documentation Support

10.1 Related Links

The table below lists quick access links. Categories include technical documents, support and community resources, tools and software, and quick access to sample or buy.

Table 1. Related Links

PARTS	PRODUCT FOLDER	SAMPLE & BUY	TECHNICAL DOCUMENTS	TOOLS & SOFTWARE	SUPPORT & COMMUNITY
LMK61E0-050M	Click here	Click here	Click here	Click here	Click here
LMK61E0-155M	Click here	Click here	Click here	Click here	Click here
LMK61E0-156M	Click here	Click here	Click here	Click here	Click here
LMK61E2-100M	Click here	Click here	Click here	Click here	Click here
LMK61E2-125M	Click here	Click here	Click here	Click here	Click here
LMK61E2-156M	Click here	Click here	Click here	Click here	Click here
LMK61E2-312M	Click here	Click here	Click here	Click here	Click here
LMK61A2-100M	Click here	Click here	Click here	Click here	Click here
LMK61A2-125M	Click here	Click here	Click here	Click here	Click here
LMK61A2-156M	Click here	Click here	Click here	Click here	Click here
LMK61A2-312M	Click here	Click here	Click here	Click here	Click here
LMK61A2-644M	Click here	Click here	Click here	Click here	Click here
LMK61I2-100M	Click here	Click here	Click here	Click here	Click here

10.2 Receiving Notification of Documentation Updates

To receive notification of documentation updates, navigate to the device product folder on ti.com. In the upper right corner, click on *Alert me* to register and receive a weekly digest of any product information that has changed. For change details, review the revision history included in any revised document.

10.3 Community Resources

The following links connect to TI community resources. Linked contents are provided "AS IS" by the respective contributors. They do not constitute TI specifications and do not necessarily reflect TI's views; see TI's [Terms of Use](#).

TI E2E™ Online Community *TI's Engineer-to-Engineer (E2E) Community*. Created to foster collaboration among engineers. At e2e.ti.com, you can ask questions, share knowledge, explore ideas and help solve problems with fellow engineers.

Design Support *TI's Design Support* Quickly find helpful E2E forums along with design support tools and contact information for technical support.

10.4 Trademarks

E2E is a trademark of Texas Instruments.
All other trademarks are the property of their respective owners.

10.5 Electrostatic Discharge Caution



These devices have limited built-in ESD protection. The leads should be shorted together or the device placed in conductive foam during storage or handling to prevent electrostatic damage to the MOS gates.

10.6 Glossary

[SLYZ022](#) — *TI Glossary*.

This glossary lists and explains terms, acronyms, and definitions.

11 Mechanical, Packaging, and Orderable Information

The following pages include mechanical, packaging, and orderable information. This information is the most current data available for the designated devices. This data is subject to change without notice and revision of this document. For browser-based versions of this data sheet, refer to the left-hand navigation.

EXAMPLE BOARD LAYOUT

SIA0006A

QFM - 1.15 mm max height

QUAD FLAT MODULE

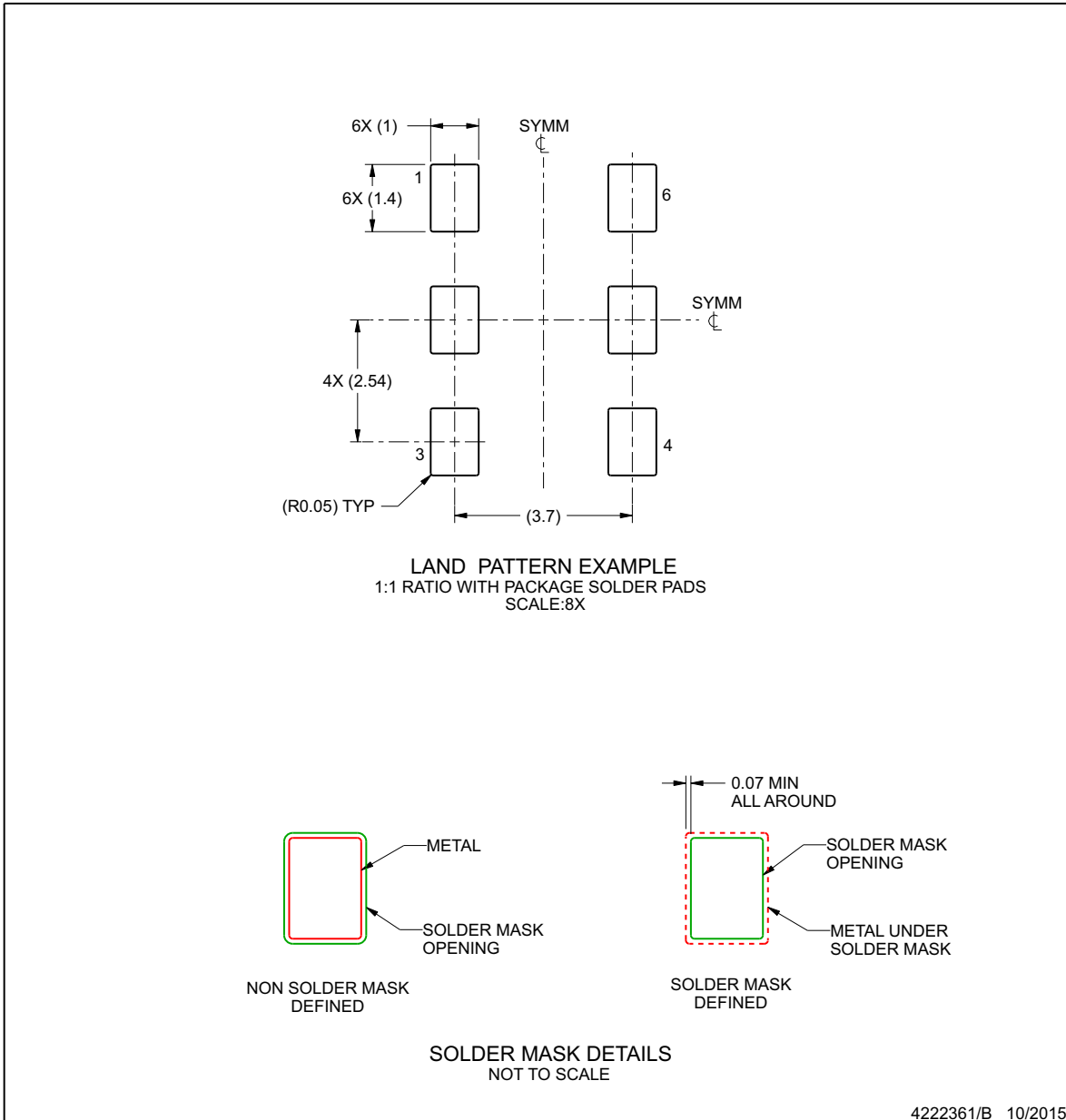

NOTES: (continued)

3. For more information, see Texas Instruments literature number SLUA271 (www.ti.com/lit/slua271).

EXAMPLE STENCIL DESIGN

SIA0006A

QFM - 1.15 mm max height

QUAD FLAT MODULE

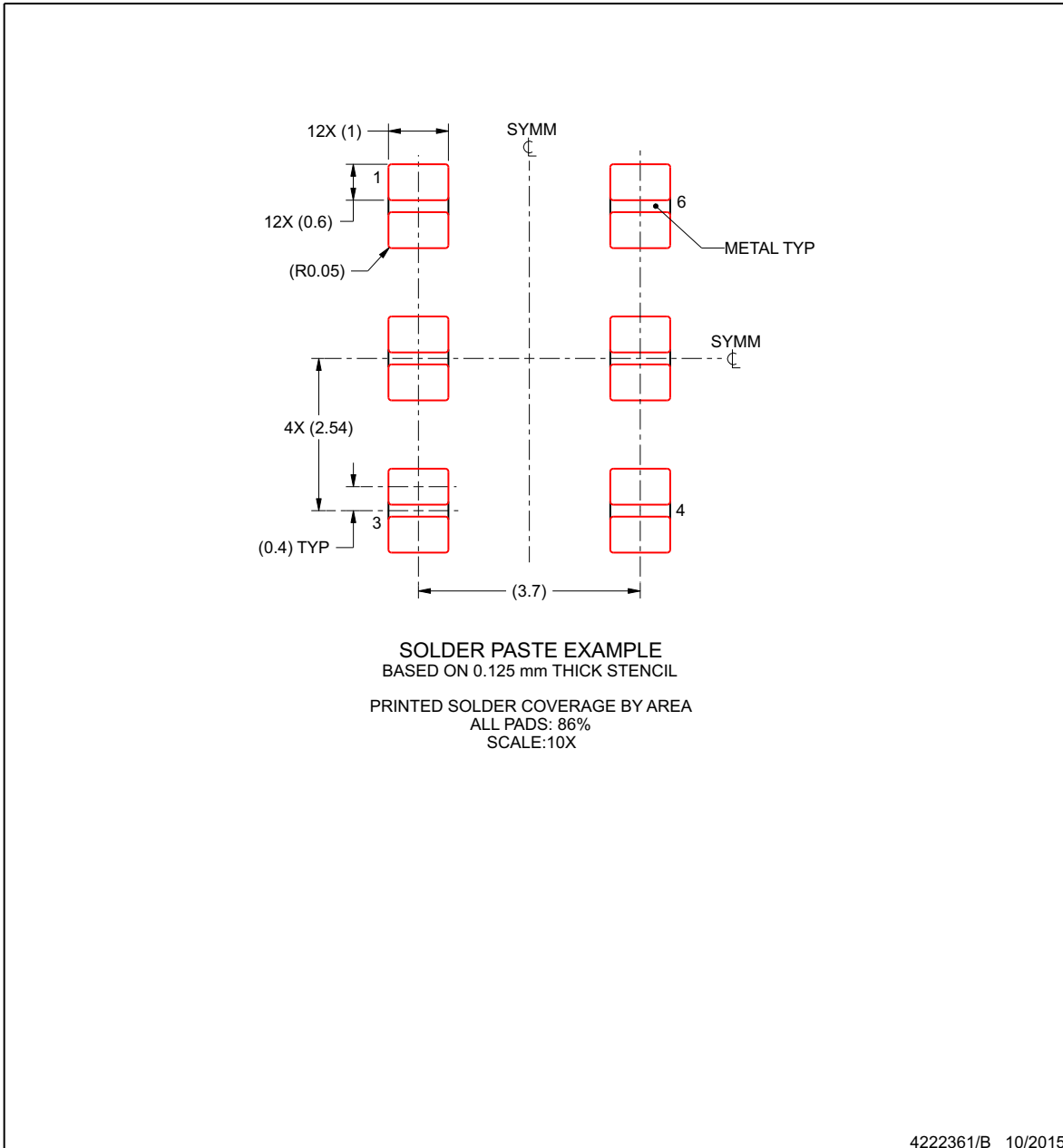

NOTES: (continued)

4. Laser cutting apertures with trapezoidal walls and rounded corners may offer better paste release. IPC-7525 may have alternate design recommendations.

PACKAGING INFORMATION

Orderable part number	Status (1)	Material type (2)	Package Pins	Package qty Carrier	RoHS (3)	Lead finish/ Ball material (4)	MSL rating/ Peak reflow (5)	Op temp (°C)	Part marking (6)
LMK61A2-100M00SIAR	Active	Production	QFM (SIA) 6	2500 LARGE T&R	Yes	NIAU	Level-3-260C-168 HR	-40 to 85	LMK61A2 100M00
LMK61A2-100M00SIAR.A	Active	Production	QFM (SIA) 6	2500 LARGE T&R	Yes	NIAU	Level-3-260C-168 HR	-40 to 85	LMK61A2 100M00
LMK61A2-100M00SIAT	Active	Production	QFM (SIA) 6	250 SMALL T&R	Yes	NIAU	Level-3-260C-168 HR	-40 to 85	LMK61A2 100M00
LMK61A2-100M00SIAT.A	Active	Production	QFM (SIA) 6	250 SMALL T&R	Yes	NIAU	Level-3-260C-168 HR	-40 to 85	LMK61A2 100M00
LMK61A2-125M00SIAR	Active	Production	QFM (SIA) 6	2500 LARGE T&R	Yes	NIAU	Level-3-260C-168 HR	-40 to 85	LMK61A2 125M00
LMK61A2-125M00SIAR.A	Active	Production	QFM (SIA) 6	2500 LARGE T&R	Yes	NIAU	Level-3-260C-168 HR	-40 to 85	LMK61A2 125M00
LMK61A2-125M00SIAT	Active	Production	QFM (SIA) 6	250 SMALL T&R	Yes	NIAU	Level-3-260C-168 HR	-40 to 85	LMK61A2 125M00
LMK61A2-125M00SIAT.A	Active	Production	QFM (SIA) 6	250 SMALL T&R	Yes	NIAU	Level-3-260C-168 HR	-40 to 85	LMK61A2 125M00
LMK61A2-156M25SIAR	Active	Production	QFM (SIA) 6	2500 LARGE T&R	Yes	NIAU	Level-3-260C-168 HR	-40 to 85	LMK61A2 156M25
LMK61A2-156M25SIAR.A	Active	Production	QFM (SIA) 6	2500 LARGE T&R	Yes	NIAU	Level-3-260C-168 HR	-40 to 85	LMK61A2 156M25
LMK61A2-156M25SIAT	Active	Production	QFM (SIA) 6	250 SMALL T&R	Yes	NIAU	Level-3-260C-168 HR	-40 to 85	LMK61A2 156M25
LMK61A2-156M25SIAT.A	Active	Production	QFM (SIA) 6	250 SMALL T&R	Yes	NIAU	Level-3-260C-168 HR	-40 to 85	LMK61A2 156M25
LMK61A2-312M50SIAR	Active	Production	QFM (SIA) 6	2500 LARGE T&R	Yes	NIAU	Level-3-260C-168 HR	-40 to 85	LMK61A2 312M50
LMK61A2-312M50SIAR.A	Active	Production	QFM (SIA) 6	2500 LARGE T&R	Yes	NIAU	Level-3-260C-168 HR	-40 to 85	LMK61A2 312M50
LMK61A2-312M50SIAT	Active	Production	QFM (SIA) 6	250 SMALL T&R	Yes	NIAU	Level-3-260C-168 HR	-40 to 85	LMK61A2 312M50
LMK61A2-312M50SIAT.A	Active	Production	QFM (SIA) 6	250 SMALL T&R	Yes	NIAU	Level-3-260C-168 HR	-40 to 85	LMK61A2 312M50

Orderable part number	Status (1)	Material type (2)	Package Pins	Package qty Carrier	RoHS (3)	Lead finish/ Ball material (4)	MSL rating/ Peak reflow (5)	Op temp (°C)	Part marking (6)
LMK61A2-644M53SIAR	Active	Production	QFM (SIA) 6	2500 LARGE T&R	Yes	NIAU	Level-3-260C-168 HR	-40 to 85	LMK61A2 644M53
LMK61A2-644M53SIAR.A	Active	Production	QFM (SIA) 6	2500 LARGE T&R	Yes	NIAU	Level-3-260C-168 HR	-40 to 85	LMK61A2 644M53
LMK61A2-644M53SIAT	Active	Production	QFM (SIA) 6	250 SMALL T&R	In-Work	NIAU	Level-3-260C-168 HR	-40 to 85	LMK61A2 644M53
LMK61A2-644M53SIAT.A	Active	Production	QFM (SIA) 6	250 SMALL T&R	In-Work	NIAU	Level-3-260C-168 HR	-40 to 85	LMK61A2 644M53
LMK61E0-050M00SIAR	Active	Production	QFM (SIA) 6	2500 LARGE T&R	Yes	NIAU	Level-3-260C-168 HR	-40 to 85	LMK61E0 050M00
LMK61E0-050M00SIAR.A	Active	Production	QFM (SIA) 6	2500 LARGE T&R	Yes	NIAU	Level-3-260C-168 HR	-40 to 85	LMK61E0 050M00
LMK61E0-050M00SIAT	Active	Production	QFM (SIA) 6	250 SMALL T&R	Yes	NIAU	Level-3-260C-168 HR	-40 to 85	LMK61E0 050M00
LMK61E0-050M00SIAT.A	Active	Production	QFM (SIA) 6	250 SMALL T&R	Yes	NIAU	Level-3-260C-168 HR	-40 to 85	LMK61E0 050M00
LMK61E0-155M52SIAR	Active	Production	QFM (SIA) 6	2500 LARGE T&R	Yes	NIAU	Level-3-260C-168 HR	-40 to 85	LMK61E0 155M52
LMK61E0-155M52SIAR.A	Active	Production	QFM (SIA) 6	2500 LARGE T&R	Yes	NIAU	Level-3-260C-168 HR	-40 to 85	LMK61E0 155M52
LMK61E0-155M52SIAT	Active	Production	QFM (SIA) 6	250 SMALL T&R	Yes	NIAU	Level-3-260C-168 HR	-40 to 85	LMK61E0 155M52
LMK61E0-155M52SIAT.A	Active	Production	QFM (SIA) 6	250 SMALL T&R	Yes	NIAU	Level-3-260C-168 HR	-40 to 85	LMK61E0 155M52
LMK61E0-156M25SIAR	Active	Production	QFM (SIA) 6	2500 LARGE T&R	Yes	NIAU	Level-3-260C-168 HR	-40 to 85	LMK61E0 156M25
LMK61E0-156M25SIAR.A	Active	Production	QFM (SIA) 6	2500 LARGE T&R	Yes	NIAU	Level-3-260C-168 HR	-40 to 85	LMK61E0 156M25
LMK61E0-156M25SIAT	Active	Production	QFM (SIA) 6	250 SMALL T&R	Yes	NIAU	Level-3-260C-168 HR	-40 to 85	LMK61E0 156M25
LMK61E0-156M25SIAT.A	Active	Production	QFM (SIA) 6	250 SMALL T&R	Yes	NIAU	Level-3-260C-168 HR	-40 to 85	LMK61E0 156M25
LMK61E2-100M00SIAR	Active	Production	QFM (SIA) 6	2500 LARGE T&R	Yes	NIAU	Level-3-260C-168 HR	-40 to 85	LMK61E2 100M00

Orderable part number	Status (1)	Material type (2)	Package Pins	Package qty Carrier	RoHS (3)	Lead finish/ Ball material (4)	MSL rating/ Peak reflow (5)	Op temp (°C)	Part marking (6)
LMK61E2-100M00SIAR.A	Active	Production	QFM (SIA) 6	2500 LARGE T&R	Yes	NIAU	Level-3-260C-168 HR	-40 to 85	LMK61E2 100M00
LMK61E2-100M00SIAT	Active	Production	QFM (SIA) 6	250 SMALL T&R	Yes	NIAU	Level-3-260C-168 HR	-40 to 85	LMK61E2 100M00
LMK61E2-100M00SIAT.A	Active	Production	QFM (SIA) 6	250 SMALL T&R	Yes	NIAU	Level-3-260C-168 HR	-40 to 85	LMK61E2 100M00
LMK61E2-125M00SIAR	Active	Production	QFM (SIA) 6	2500 LARGE T&R	Yes	NIAU	Level-3-260C-168 HR	-40 to 85	LMK61E2 125M00
LMK61E2-125M00SIAR.A	Active	Production	QFM (SIA) 6	2500 LARGE T&R	Yes	NIAU	Level-3-260C-168 HR	-40 to 85	LMK61E2 125M00
LMK61E2-125M00SIAT	Active	Production	QFM (SIA) 6	250 SMALL T&R	Yes	NIAU	Level-3-260C-168 HR	-40 to 85	LMK61E2 125M00
LMK61E2-125M00SIAT.A	Active	Production	QFM (SIA) 6	250 SMALL T&R	Yes	NIAU	Level-3-260C-168 HR	-40 to 85	LMK61E2 125M00
LMK61E2-156M25SIAR	Active	Production	QFM (SIA) 6	2500 LARGE T&R	Yes	NIAU	Level-3-260C-168 HR	-40 to 85	LMK61E2 156M25
LMK61E2-156M25SIAR.A	Active	Production	QFM (SIA) 6	2500 LARGE T&R	Yes	NIAU	Level-3-260C-168 HR	-40 to 85	LMK61E2 156M25
LMK61E2-156M25SIAT	Active	Production	QFM (SIA) 6	250 SMALL T&R	Yes	NIAU	Level-3-260C-168 HR	-40 to 85	LMK61E2 156M25
LMK61E2-156M25SIAT.A	Active	Production	QFM (SIA) 6	250 SMALL T&R	Yes	NIAU	Level-3-260C-168 HR	-40 to 85	LMK61E2 156M25
LMK61E2-312M50SIAR	Active	Production	QFM (SIA) 6	2500 LARGE T&R	Yes	NIAU	Level-3-260C-168 HR	-40 to 85	LMK61E2 312M50
LMK61E2-312M50SIAR.A	Active	Production	QFM (SIA) 6	2500 LARGE T&R	Yes	NIAU	Level-3-260C-168 HR	-40 to 85	LMK61E2 312M50
LMK61E2-312M50SIAT	Active	Production	QFM (SIA) 6	250 SMALL T&R	Yes	NIAU	Level-3-260C-168 HR	-40 to 85	LMK61E2 312M50
LMK61E2-312M50SIAT.A	Active	Production	QFM (SIA) 6	250 SMALL T&R	Yes	NIAU	Level-3-260C-168 HR	-40 to 85	LMK61E2 312M50
LMK61I2-100M00SIAR	Active	Production	QFM (SIA) 6	2500 LARGE T&R	Yes	NIAU	Level-3-260C-168 HR	-40 to 85	LMK61I2 100M00
LMK61I2-100M00SIAR.A	Active	Production	QFM (SIA) 6	2500 LARGE T&R	Yes	NIAU	Level-3-260C-168 HR	-40 to 85	LMK61I2 100M00

Orderable part number	Status (1)	Material type (2)	Package Pins	Package qty Carrier	RoHS (3)	Lead finish/ Ball material (4)	MSL rating/ Peak reflow (5)	Op temp (°C)	Part marking (6)
LMK61I2-100M00SIAT	Active	Production	QFM (SIA) 6	250 SMALL T&R	In-Work	NIAU	Level-3-260C-168 HR	-40 to 85	LMK61I2 100M00
LMK61I2-100M00SIAT.A	Active	Production	QFM (SIA) 6	250 SMALL T&R	In-Work	NIAU	Level-3-260C-168 HR	-40 to 85	LMK61I2 100M00

(1) **Status:** For more details on status, see our [product life cycle](#).

(2) **Material type:** When designated, preproduction parts are prototypes/experimental devices, and are not yet approved or released for full production. Testing and final process, including without limitation quality assurance, reliability performance testing, and/or process qualification, may not yet be complete, and this item is subject to further changes or possible discontinuation. If available for ordering, purchases will be subject to an additional waiver at checkout, and are intended for early internal evaluation purposes only. These items are sold without warranties of any kind.

(3) **RoHS values:** Yes, No, RoHS Exempt. See the [TI RoHS Statement](#) for additional information and value definition.

(4) **Lead finish/Ball material:** Parts may have multiple material finish options. Finish options are separated by a vertical ruled line. Lead finish/Ball material values may wrap to two lines if the finish value exceeds the maximum column width.

(5) **MSL rating/Peak reflow:** The moisture sensitivity level ratings and peak solder (reflow) temperatures. In the event that a part has multiple moisture sensitivity ratings, only the lowest level per JEDEC standards is shown. Refer to the shipping label for the actual reflow temperature that will be used to mount the part to the printed circuit board.

(6) **Part marking:** There may be an additional marking, which relates to the logo, the lot trace code information, or the environmental category of the part.

Multiple part markings will be inside parentheses. Only one part marking contained in parentheses and separated by a "-" will appear on a part. If a line is indented then it is a continuation of the previous line and the two combined represent the entire part marking for that device.

Important Information and Disclaimer: The information provided on this page represents TI's knowledge and belief as of the date that it is provided. TI bases its knowledge and belief on information provided by third parties, and makes no representation or warranty as to the accuracy of such information. Efforts are underway to better integrate information from third parties. TI has taken and continues to take reasonable steps to provide representative and accurate information but may not have conducted destructive testing or chemical analysis on incoming materials and chemicals. TI and TI suppliers consider certain information to be proprietary, and thus CAS numbers and other limited information may not be available for release.

In no event shall TI's liability arising out of such information exceed the total purchase price of the TI part(s) at issue in this document sold by TI to Customer on an annual basis.

IMPORTANT NOTICE AND DISCLAIMER

TI PROVIDES TECHNICAL AND RELIABILITY DATA (INCLUDING DATASHEETS), DESIGN RESOURCES (INCLUDING REFERENCE DESIGNS), APPLICATION OR OTHER DESIGN ADVICE, WEB TOOLS, SAFETY INFORMATION, AND OTHER RESOURCES "AS IS" AND WITH ALL FAULTS, AND DISCLAIMS ALL WARRANTIES, EXPRESS AND IMPLIED, INCLUDING WITHOUT LIMITATION ANY IMPLIED WARRANTIES OF MERCHANTABILITY, FITNESS FOR A PARTICULAR PURPOSE OR NON-INFRINGEMENT OF THIRD PARTY INTELLECTUAL PROPERTY RIGHTS.

These resources are intended for skilled developers designing with TI products. You are solely responsible for (1) selecting the appropriate TI products for your application, (2) designing, validating and testing your application, and (3) ensuring your application meets applicable standards, and any other safety, security, regulatory or other requirements.

These resources are subject to change without notice. TI grants you permission to use these resources only for development of an application that uses the TI products described in the resource. Other reproduction and display of these resources is prohibited. No license is granted to any other TI intellectual property right or to any third party intellectual property right. TI disclaims responsibility for, and you fully indemnify TI and its representatives against any claims, damages, costs, losses, and liabilities arising out of your use of these resources.

TI's products are provided subject to [TI's Terms of Sale](#), [TI's General Quality Guidelines](#), or other applicable terms available either on ti.com or provided in conjunction with such TI products. TI's provision of these resources does not expand or otherwise alter TI's applicable warranties or warranty disclaimers for TI products. Unless TI explicitly designates a product as custom or customer-specified, TI products are standard, catalog, general purpose devices.

TI objects to and rejects any additional or different terms you may propose.

Copyright © 2026, Texas Instruments Incorporated

Last updated 10/2025

OUR CERTIFICATE

DiGi provide top-quality products and perfect service for customer worldwide through standardization, technological innovation and continuous improvement. DiGi through third-party certification, we stricly control the quality of products and services. Welcome your RFQ to

Email: Info@DiGi-Electronics.com



Tel: +00 852-30501935

RFQ Email: Info@DiGi-Electronics.com

DiGi is a global authorized distributor of electronic components.