

LP38853SX-ADJ/NOPB Datasheet

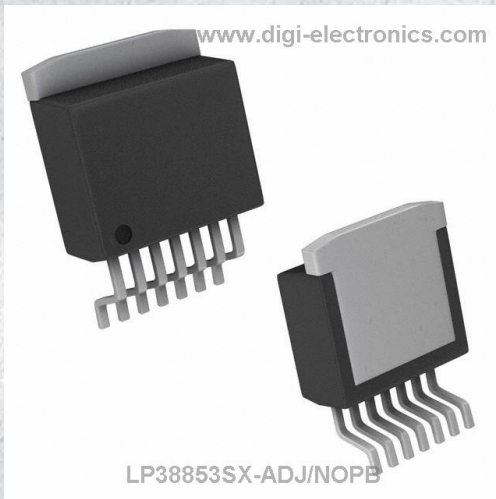

<https://www.DiGi-Electronics.com>

DiGi Electronics Part Number	LP38853SX-ADJ/NOPB-DG
Manufacturer	Texas Instruments
Manufacturer Product Number	LP38853SX-ADJ/NOPB
Description	IC REG LIN POS ADJ 3A DDPAK
Detailed Description	Linear Voltage Regulator IC Positive Adjustable 1 O utput 3A TO-263 (DDPAK-7)



Tel: +00 852-30501935

RFQ Email: Info@DiGi-Electronics.com

DiGi is a global authorized distributor of electronic components.

Purchase and inquiry

Manufacturer Product Number:

LP38853SX-ADJ/NOPB

Series:

-

Output Configuration:

Positive

Number of Regulators:

1

Voltage - Output (Min/Fixed):

0.8V

Voltage Dropout (Max):

0.45V @ 3A

Current - Quiescent (Iq):

300 μ A

PSRR:

80dB ~ 70dB (120Hz ~ 1kHz)

Protection Features:

Over Current, Over Temperature, Short Circuit, Under Voltage Lockout (UVLO)

Mounting Type:

Surface Mount

Supplier Device Package:

TO-263 (DDPAK-7)

Manufacturer:

Texas Instruments

Product Status:

Active

Output Type:

Adjustable

Voltage - Input (Max):

5.5V

Voltage - Output (Max):

1.8V

Current - Output:

3A

Current - Supply (Max):

9 mA

Control Features:

Enable, Soft Start

Operating Temperature:

-40°C ~ 125°C

Package / Case:

TO-263-8, D2PAK (7 Leads + Tab), TO-263CA

Base Product Number:

LP38853

Environmental & Export classification

RoHS Status:

ROHS3 Compliant

REACH Status:

REACH Unaffected

HTSUS:

8542.39.0001

Moisture Sensitivity Level (MSL):

3 (168 Hours)

ECCN:

EAR99

LP38853 3-A Fast-Response High-Accuracy Adjustable LDO Linear Regulator With Enable and Soft Start

1 Features

- Wide V_{BIAS} Supply Operating Range: 3 V to 5.5 V
- Adjustable V_{OUT} Range: 0.8 V to 1.8 V
- Dropout Voltage of 240 mV (Typical) at 3-A Load Current
- Precision V_{ADJ} Across All Line and Load Conditions:
 - $\pm 1.5\%$ V_{ADJ} for $T_J = 25^\circ\text{C}$
 - $\pm 2\%$ V_{ADJ} for $0^\circ\text{C} \leq T_J \leq +125^\circ\text{C}$
 - $\pm 3\%$ V_{ADJ} for $-40^\circ\text{C} \leq T_J \leq +125^\circ\text{C}$
- Overtemperature and Overcurrent Protection
- Stable with 10- μF Ceramic Capacitors
- -40°C to $+125^\circ\text{C}$ Operating Junction Temperature Range

2 Applications

- ASIC Power Supplies in:
 - Desktops, Notebooks, Graphics Cards, and Servers
 - Gaming Set-Top Boxes, Printers, and Copiers
- Server Core and I/O Supplies
- DSP and FPGA Power Supplies
- SMPS Post-Regulator

3 Description

The LP38853 is a high-current, fast-response regulator that can maintain output voltage regulation with extremely low input-to-output voltage drop. Fabricated on a CMOS process, the device operates from two input voltages: V_{BIAS} provides voltage to drive the gate of the NMOS power transistor; V_{IN} is the input voltage which supplies power to the load. The use of an external bias rail allows the device to operate from ultra-low V_{IN} voltages. Unlike bipolar regulators, the CMOS architecture consumes extremely low quiescent current at any output load current. The use of an NMOS power transistor results in wide bandwidth, yet minimum external capacitance is required to maintain loop stability.

The fast transient response of this device makes it suitable for use in powering DSP and microcontroller core voltages, and switch-mode power-supply post regulators.

- Dropout Voltage: 240 mV (typical) at 3-A load current
- Low Ground Pin Current: 10 mA (typical) at 3-A load current
- Soft Start: Programmable soft-start time

Device Information⁽¹⁾

PART NUMBER	PACKAGE	BODY SIZE (NOM)
LP38853	DDPAK/TO-263 (7)	10.10 mm x 8.89 mm
	TO-220 (7)	14.986 x 10.16 mm
	SO PowerPAD™ (8)	4.89 mm x 3.90 mm

(1) For all available packages, see the orderable addendum at the end of the data sheet.

Simplified Schematic

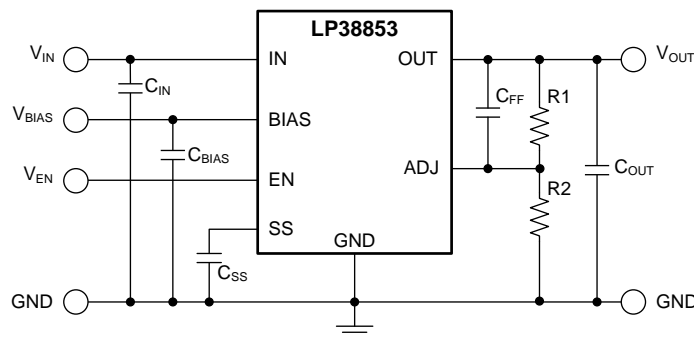

LP38853

SNVS335F – DECEMBER 2006 – REVISED NOVEMBER 2016

www.ti.com

Table of Contents

1 Features	1	7.3 Feature Description	11
2 Applications	1	7.4 Device Functional Modes	14
3 Description	1	8 Application and Implementation	15
4 Revision History	2	8.1 Application Information	15
5 Pin Configuration and Functions	3	8.2 Typical Application	15
6 Specifications	4	9 Power Supply Recommendations	19
6.1 Absolute Maximum Ratings	4	10 Layout	19
6.2 ESD Ratings	4	10.1 Layout Guidelines	19
6.3 Recommended Operating Conditions	4	10.2 Layout Examples	19
6.4 Thermal Information	5	11 Device and Documentation Support	20
6.5 Electrical Characteristics	5	11.1 Documentation Support	20
6.6 Timing Requirements	6	11.2 Community Resources	20
6.7 Typical Characteristics	7	11.3 Trademarks	20
7 Detailed Description	11	11.4 Electrostatic Discharge Caution	20
7.1 Overview	11	11.5 Glossary	20
7.2 Functional Block Diagram	11	12 Mechanical, Packaging, and Orderable Information	20

4 Revision History

NOTE: Page numbers for previous revisions may differ from page numbers in the current version.

Changes from Revision E (November 2015) to Revision F	Page
• corrected layout drawings	19

Changes from Revision D (April 2015) to Revision E	Page
• Changed part number to LP38853 throughout data sheet	1
• Added <i>Device Information</i> and <i>Pin Configuration and Functions</i> sections, <i>ESD Ratings</i> and <i>Thermal Information</i> tables, <i>Feature Description</i> , <i>Device Functional Modes</i> , <i>Application and Implementation</i> , <i>Power Supply Recommendations</i> , <i>Layout</i> , <i>Device and Documentation Support</i> , and <i>Mechanical, Packaging, and Orderable Information</i> sections	1
• Deleted Lead temperature from Abs Max table; it is in POA	4
• Added updated thermal information	5
• Deleted out-of-date heatsinking subsections	17

Changes from Revision C (April 2013) to Revision D	Page
• Changed layout of National Data Sheet to TI format	19

5 Pin Configuration and Functions

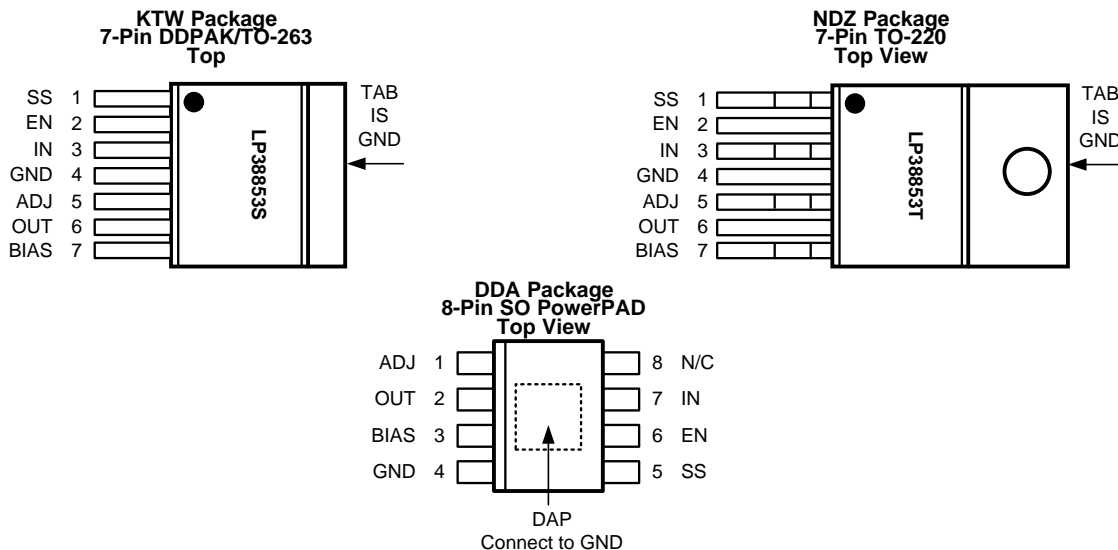

Pin Functions

NAME	PIN			TYPE	DESCRIPTION
	DDPAK/TO-263	TO-220	SO PowerPAD-8		
ADJ	5	5	1	O	The feedback connection to set the output voltage
BIAS	7	7	3	I	The supply for the internal control and reference circuitry.
EN	2	2	6	I	Device enable, High = On, Low = Off.
DAP	—	—	DAP	—	The SO PowerPAD DAP is a thermal connection only that is physically attached to the backside of the die, and used as a thermal heat-sink connection.
GND	4	4	4	GND	Ground
IN	3	3	7	I	The unregulated voltage input
N/C	—	—	8	—	No internal connection
OUT	6	6	2	O	The regulated output voltage
SS	1	1	5	O	Soft-start capacitor connection. Used to control the rise time of V_{OUT} at turnon.
TAB	TAB	TAB	—	—	The KTW and NDZ TAB is a thermal and electrical connection that is physically attached to the backside of the die, and used as a thermal heat-sink connection.

LP38853

SNVS335F – DECEMBER 2006 – REVISED NOVEMBER 2016

www.ti.com

6 Specifications**6.1 Absolute Maximum Ratings**over operating free-air temperature range (unless otherwise noted)⁽¹⁾⁽²⁾

	MIN	MAX	UNIT
V _{IN} supply voltage (survival)	-0.3	6	V
V _{BIAS} supply voltage (survival)	-0.3	6	V
V _{SS} soft-start voltage (survival)	-0.3	6	V
V _{OUT} voltage (survival)	-0.3	6	V
I _{OUT} current (survival)	Internally Limited		
Junction temperature	-40	150	°C
Power dissipation ⁽³⁾	Internally Limited		
Storage temperature, T _{stg}	-65	150	°C

- (1) Stresses beyond those listed under *Absolute Maximum Ratings* may cause permanent damage to the device. These are stress ratings only, which do not imply functional operation of the device at these or any other conditions beyond those indicated under *Recommended Operating Conditions*. Exposure to absolute-maximum-rated conditions for extended periods may affect device reliability.
- (2) If Military/Aerospace specified devices are required, contact the TI Sales Office/ Distributors for availability and specifications.
- (3) Device power dissipation must be de-rated based on device power dissipation (P_D), ambient temperature (T_A), and package junction-to-ambient thermal resistance (R_{θJA}). Additional heat sinking may be required to ensure that the device junction temperature (T_J) does not exceed the maximum operating rating. See the *Application and Implementation* section for details.

6.2 ESD Ratings

	VALUE	UNIT
V _(ESD) Electrostatic discharge Human-body model (HBM), per ANSI/ESDA/JEDEC JS-001 ⁽¹⁾	±2000	V

- (1) JEDEC document JEP155 states that 500-V HBM allows safe manufacturing with a standard ESD control process.

6.3 Recommended Operating Conditionsover operating free-air temperature range (unless otherwise noted)⁽¹⁾

	MIN	MAX	UNIT	
V _{IN} supply voltage (survival)		(V _{OUT} + V _{DO}) to V _{BIAS}	V	
V _{BIAS} supply voltage (survival) ⁽²⁾	0.8 V ≤ V _{OUT} ≤ 1.2 V	3	5.5	V
	1.2 V < V _{OUT} ≤ 1.8 V	4.5	5.5	V
V _{EN} voltage	0	V _{BIAS}	V	
I _{OUT}	0	3	mA	
Junction temperature ⁽³⁾	-40	125	°C	

- (1) Stresses beyond those listed under *Absolute Maximum Ratings* may cause permanent damage to the device. These are stress ratings only, which do not imply functional operation of the device at these or any other conditions beyond those indicated under *Recommended Operating Conditions*. Exposure to absolute-maximum-rated conditions for extended periods may affect device reliability.
- (2) V_{IN} cannot exceed either V_{BIAS} or 4.5 V, whichever value is lower.
- (3) Device power dissipation must be de-rated based on device power dissipation (P_D), ambient temperature (T_A), and package junction to ambient thermal resistance (R_{θJA}). Additional heat-sinking may be required to ensure that the device junction temperature (T_J) does not exceed the maximum operating rating. See the *Application and Implementation* section for details.

6.4 Thermal Information

THERMAL METRIC ⁽¹⁾	LP38853			UNIT
	KTW (DDPAK/TO-263)	NDZ (TO-220)	DDA (SO PowerPAD)	
	7 PINS	7 PINS	8 PINS	
R _{θJA} Junction-to-ambient thermal resistance	34.3	34.0	48.4	°C/W
R _{θJC(top)} Junction-to-case (top) thermal resistance	37.6	36.4	54.6	°C/W
R _{θJB} Junction-to-board thermal resistance	25.3	25.0	29.1	°C/W
ψ _{JT} Junction-to-top characterization parameter	6.6	6.3	9.6	°C/W
ψ _{JB} Junction-to-board characterization parameter	24.0	23.6	29.0	°C/W
R _{θJC(bot)} Junction-to-case (bottom) thermal resistance	n/a	n/a	4.3	°C/W

- (1) For more information about traditional and new thermal metrics, see the *Semiconductor and IC Package Thermal Metrics* application report, [SPRA953](#).

6.5 Electrical Characteristics

Unless otherwise specified: V_{OUT} = 0.8 V, V_{IN} = V_{OUT(NOM)} + 1 V, V_{BIAS} = 3 V, V_{EN} = V_{BIAS}, I_{OUT} = 10 mA, C_{IN} = C_{OUT} = 10 μF, C_{BIAS} = 1 μF, C_{SS} = open; typical (TYP) limits are for T_J = 25°C only, and minimum (MIN) and maximum (MAX) limits apply over the junction temperature (T_J) range of –40°C to +125°C. Minimum and Maximum limits are specified through test, design, or statistical correlation. Typical values represent the most likely parametric norm at T_J = 25°C, and are provided for reference purposes only.

PARAMETER	TEST CONDITIONS	MIN	TYP	MAX	UNIT
V _{ADJ} V _{ADJ} accuracy	V _{OUT(NOM)} + 1 V ≤ V _{IN} ≤ V _{BIAS} ≤ 4.5 V ⁽¹⁾ 3 V ≤ V _{BIAS} ≤ 5.5 V, 10 mA ≤ I _{OUT} ≤ 3 A T _J = 25°C	492.5	500	507.5	mV
	V _{OUT(NOM)} + 1 V ≤ V _{IN} ≤ V _{BIAS} ≤ 4.5 V ⁽¹⁾ 3 V ≤ V _{BIAS} ≤ 5.5 V, 10 mA ≤ I _{OUT} ≤ 3 A	485		515	
	V _{OUT(NOM)} + 1 V ≤ V _{IN} ≤ V _{BIAS} ≤ 4.5 V ⁽¹⁾ 3 V ≤ V _{BIAS} ≤ 5.5 V, 10 mA ≤ I _{OUT} ≤ 3 A, 0°C ≤ T _J ≤ 125°C	490	500	510	
V _{OUT} V _{OUT} range	3 V ≤ V _{BIAS} ≤ 5.5 V	0.8		1.2	V
	4.5 V ≤ V _{BIAS} ≤ 5.5 V	0.8		1.8	
ΔV _{OUT} /ΔV _{IN} Line regulation, V _{IN} ⁽²⁾	V _{OUT(NOM)} + 1 V ≤ V _{IN} ≤ V _{BIAS}		0.04		%/V
ΔV _{OUT} /ΔV _{BIAS} Line regulation, V _{BIAS} ⁽²⁾	3 V ≤ V _{BIAS} ≤ 5.5 V		0.1		%/V
ΔV _{OUT} /ΔI _{OUT} Output voltage load regulation ⁽³⁾	10 mA ≤ I _{OUT} ≤ 3 A		0.2		%/A
V _{DO} Dropout voltage ⁽⁴⁾	I _{OUT} = 3 A, T _J = 25°C		240	300	mV
	I _{OUT} = 3 A			450	
I _{GND(IN)} Quiescent current drawn from V _{IN} supply	V _{OUT} = 0.8 V, V _{BIAS} = 3 V 10 mA ≤ I _{OUT} ≤ 3 A T _J = 25°C		7	8.5	mA
	V _{OUT} = 0.8 V, V _{BIAS} = 3 V 10 mA ≤ I _{OUT} ≤ 3 A			9	
	V _{EN} ≤ 0.5 V, T _J = 25°C		1	100	μA
	V _{EN} ≤ 0.5 V			300	
I _{GND(BIAS)} Quiescent current drawn from V _{BIAS} supply	10 mA ≤ I _{OUT} ≤ 3 A, T _J = 25°C		3	3.8	mA
	10 mA ≤ I _{OUT} ≤ 3 A			4.5	
	V _{EN} ≤ 0.5 V, T _J = 25°C		100	170	μA
	V _{EN} ≤ 0.5 V			200	

(1) V_{IN} cannot exceed either V_{BIAS} or 4.5 V, whichever value is lower.

(2) Output voltage line regulation is defined as the change in output voltage from nominal value resulting from a change in input voltage.

(3) Output voltage load regulation is defined as the change in output voltage from nominal value as the load current increases from no load to full load.

(4) Dropout voltage is defined as the input to output voltage differential (V_{IN} – V_{OUT}) where the input voltage is low enough to cause the output voltage to drop 2% from the nominal value.

LP38853

SNVS335F – DECEMBER 2006 – REVISED NOVEMBER 2016

www.ti.com

Electrical Characteristics (continued)

Unless otherwise specified: $V_{OUT} = 0.8\text{ V}$, $V_{IN} = V_{OUT(NOM)} + 1\text{ V}$, $V_{BIAS} = 3\text{ V}$, $V_{EN} = V_{BIAS}$, $I_{OUT} = 10\text{ mA}$, $C_{IN} = C_{OUT} = 10\text{ }\mu\text{F}$, $C_{BIAS} = 1\text{ }\mu\text{F}$, $C_{SS} = \text{open}$; typical (TYP) limits are for $T_J = 25^\circ\text{C}$ only, and minimum (MIN) and maximum (MAX) limits apply over the junction temperature (T_J) range of -40°C to $+125^\circ\text{C}$. Minimum and Maximum limits are specified through test, design, or statistical correlation. Typical values represent the most likely parametric norm at $T_J = 25^\circ\text{C}$, and are provided for reference purposes only.

PARAMETER		TEST CONDITIONS	MIN	TYP	MAX	UNIT
UVLO	Undervoltage lockout threshold	V_{BIAS} rising until device is functional, $T_J = 25^\circ\text{C}$	2.2	2.45	2.7	V
		V_{BIAS} rising until device is functional	2		2.9	
UVLO _(HYS)	Undervoltage lockout hysteresis	V_{BIAS} falling from UVLO threshold until device is non-functional $T_J = 25^\circ\text{C}$	60	150	300	mV
		V_{BIAS} falling from UVLO threshold until device is non-functional	50		350	
I_{SC}	Output short-circuit current	$V_{IN} = V_{OUT(NOM)} + 1\text{ V}$, $V_{BIAS} = 3\text{ V}$, $V_{OUT} = 0\text{ V}$		5.8		A
SOFT-START						
r_{SS}	Soft-start internal resistance		11	13.5	16	k Ω
t_{SS}	Soft-start time $t_{SS} = C_{SS} \times r_{SS} \times 5$	$C_{SS} = 10\text{ nF}$		675		μs
ENABLE						
I_{EN}	ENABLE pin current	$V_{EN} = V_{BIAS}$		0.01		μA
		$V_{EN} = 0\text{ V}$, $V_{BIAS} = 5.5\text{ V}$, $T_J = 25^\circ\text{C}$	-19	-30	-40	
		$V_{EN} = 0\text{ V}$, $V_{BIAS} = 5.5\text{ V}$	-13		-51	
$V_{EN(ON)}$	Enable voltage threshold	V_{EN} rising until output = ON, $T_J = 25^\circ\text{C}$	1	1.25	1.5	V
		V_{EN} rising until output = ON	0.9		1.55	
$V_{EN(HYS)}$	Enable voltage hysteresis	V_{EN} falling from $V_{EN(ON)}$ until Output = OFF $T_J = 25^\circ\text{C}$	50	100	150	mV
		V_{EN} falling from $V_{EN(ON)}$ until Output = OFF	30		200	
AC PARAMETERS						
PSRR (V_{IN})	Ripple rejection for V_{IN} input voltage	$V_{IN} = V_{OUT(NOM)} + 1\text{ V}$, $f = 120\text{ Hz}$		80		dB
		$V_{IN} = V_{OUT(NOM)} + 1\text{ V}$, $f = 1\text{ kHz}$		70		
PSRR (V_{BIAS})	Ripple rejection for V_{BIAS} voltage	$V_{BIAS} = V_{OUT(NOM)} + 3\text{ V}$, $f = 120\text{ Hz}$		58		
		$V_{BIAS} = V_{OUT(NOM)} + 3\text{ V}$, $f = 1\text{ kHz}$		58		
e_n	Output noise density	$f = 120\text{ Hz}$		1		$\mu\text{V}/\sqrt{\text{Hz}}$
	Output noise voltage	BW = 10 Hz – 100 kHz		150		μV_{RMS}
		BW = 300 Hz – 300 kHz		90		
THERMAL PARAMETERS						
T_{SD}	Thermal shutdown junction temperature			160		$^\circ\text{C}$
$T_{SD(HYS)}$	Thermal shutdown hysteresis			10		

6.6 Timing Requirements

		MIN	NOM	MAX	UNIT
t_{OFF}	Turnoff delay time, $R_{LOAD} \times C_{OUT} \ll t_{OFF}$		20		μs
t_{ON}	Turnon delay time, $R_{LOAD} \times C_{OUT} \ll t_{ON}$		15		μs

6.7 Typical Characteristics

Refer to the [Simplified Schematic](#). Unless otherwise specified: $T_J = 25^\circ\text{C}$, $R_1 = 1.4\text{ k}\Omega$, $R_2 = 1\text{ k}\Omega$, $C_{FF} = 0.01\text{ }\mu\text{F}$, $V_{IN} = V_{OUT(NOM)} + 1\text{ V}$, $V_{BIAS} = 3\text{ V}$, $I_{OUT} = 10\text{ mA}$, $C_{IN} = 10\text{-}\mu\text{F ceramic}$, $C_{OUT} = 10\text{-}\mu\text{F ceramic}$, $C_{BIAS} = 1\text{-}\mu\text{F ceramic}$, $C_{SS} = \text{open}$.

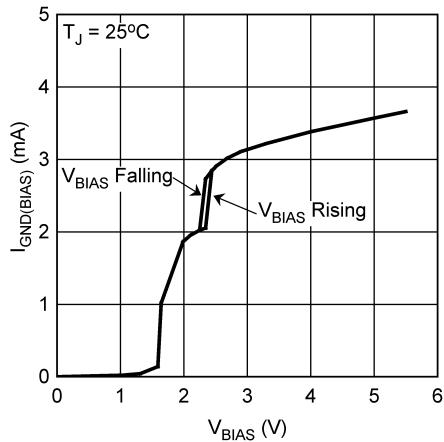

Figure 1. BIAS Ground Pin Current ($I_{GND(BIAS)}$) vs V_{BIAS}

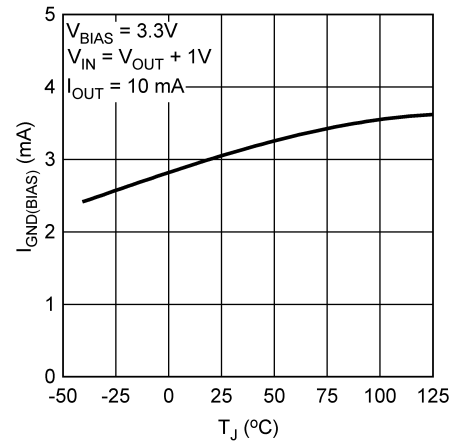

Figure 2. BIAS Ground Pin Current ($I_{GND(BIAS)}$) vs Temperature

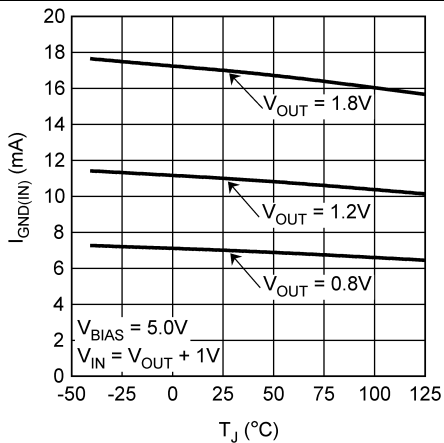

Figure 3. IN Ground Pin Current vs Temperature

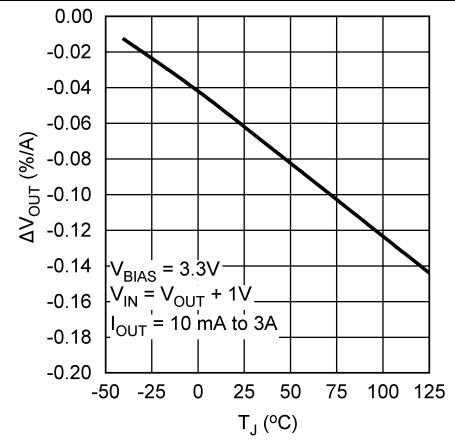

Figure 4. Load Regulation vs Temperature

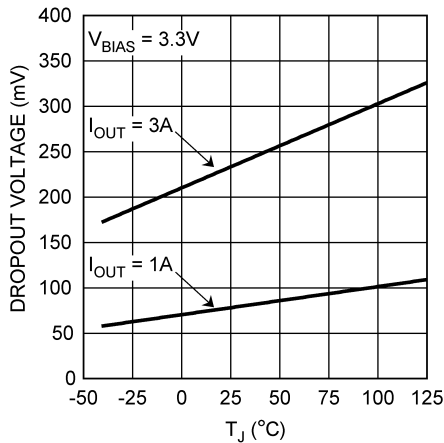

Figure 5. Dropout Voltage (V_{DO}) vs Temperature

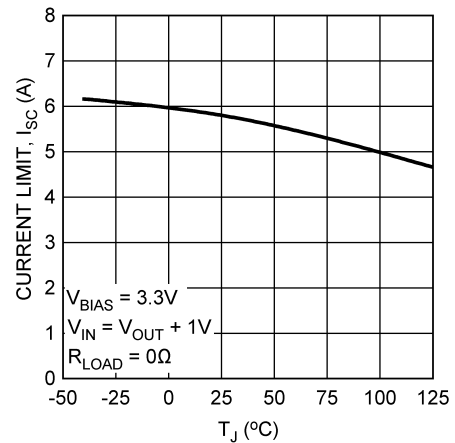

Figure 6. Output Current Limit (I_{SC}) vs Temperature

LP38853

SNVS335F – DECEMBER 2006 – REVISED NOVEMBER 2016

www.ti.com

Typical Characteristics (continued)

Refer to the [Simplified Schematic](#). Unless otherwise specified: $T_J = 25^\circ\text{C}$, $R_1 = 1.4\text{ k}\Omega$, $R_2 = 1\text{ k}\Omega$, $C_{FF} = 0.01\text{ }\mu\text{F}$, $V_{IN} = V_{OUT(NOM)} + 1\text{ V}$, $V_{BIAS} = 3\text{ V}$, $I_{OUT} = 10\text{ mA}$, $C_{IN} = 10\text{-}\mu\text{F ceramic}$, $C_{OUT} = 10\text{-}\mu\text{F ceramic}$, $C_{BIAS} = 1\text{-}\mu\text{F ceramic}$, $C_{SS} = \text{open}$.

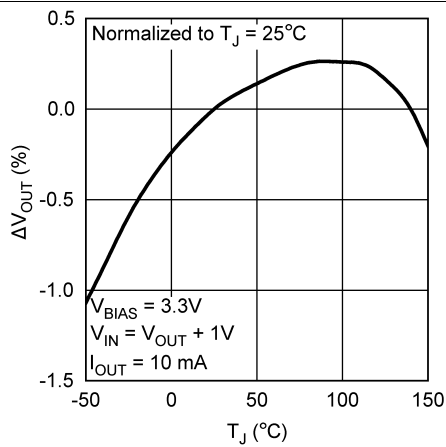
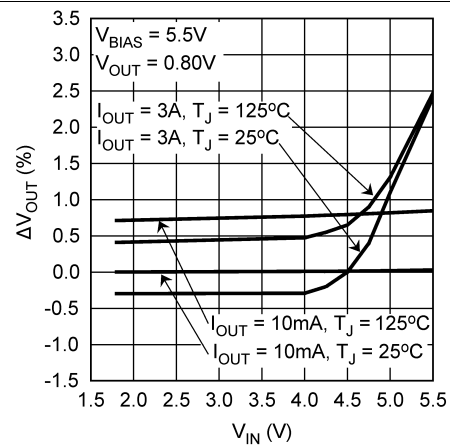
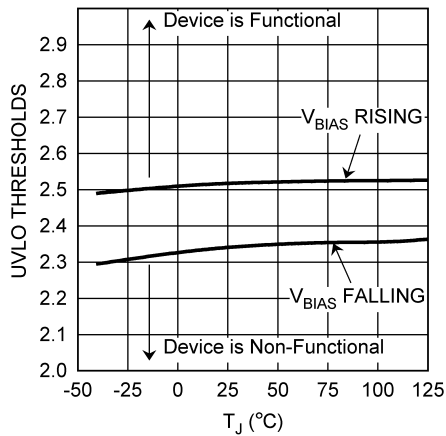
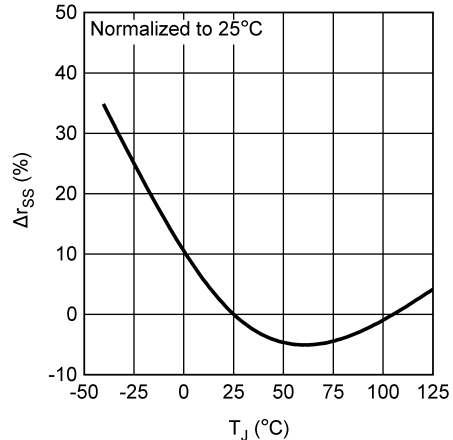
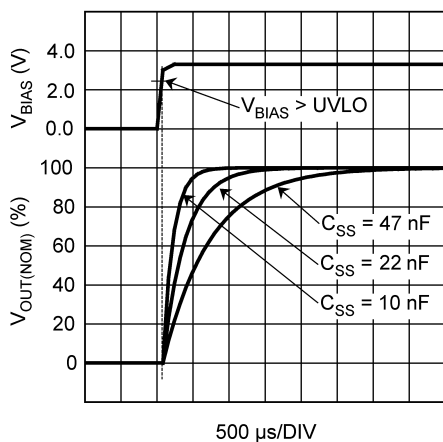
**Figure 7. V_{OUT} vs Temperature****Figure 8. V_{OUT} vs V_{IN}** **Figure 9. UVLO Thresholds vs Temperature****Figure 10. Soft-Start R_{SS} Variation vs Temperature**

10 nF to 47 nF

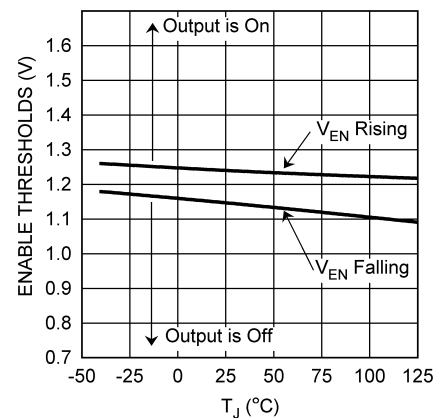
Figure 11. V_{OUT} vs C_{SS} **Figure 12. Enable Thresholds (V_{EN}) vs Temperature**

Typical Characteristics (continued)

Refer to the [Simplified Schematic](#). Unless otherwise specified: $T_J = 25^\circ\text{C}$, $R_1 = 1.4\text{ k}\Omega$, $R_2 = 1\text{ k}\Omega$, $C_{FF} = 0.01\text{ }\mu\text{F}$, $V_{IN} = V_{OUT(NOM)} + 1\text{ V}$, $V_{BIAS} = 3\text{ V}$, $I_{OUT} = 10\text{ mA}$, $C_{IN} = 10\text{-}\mu\text{F ceramic}$, $C_{OUT} = 10\text{-}\mu\text{F ceramic}$, $C_{BIAS} = 1\text{-}\mu\text{F ceramic}$, $C_{SS} = \text{open}$.

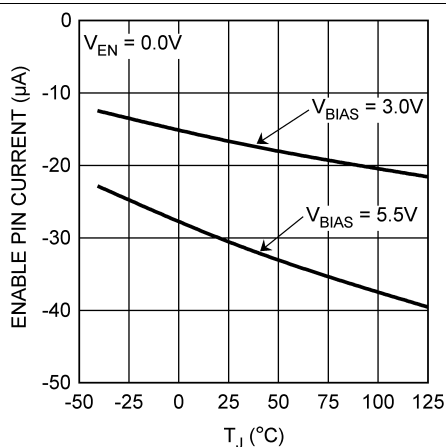

Figure 13. Enable Pulldown Current (I_{EN}) vs Temperature

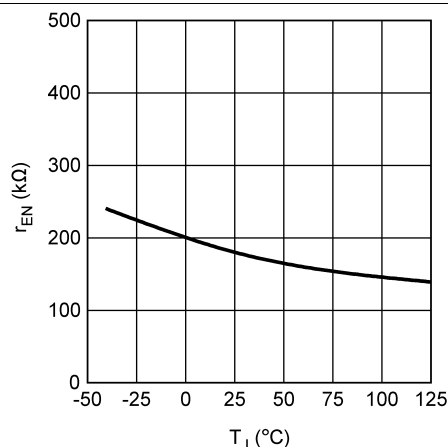

Figure 14. Enable Pullup Resistor (R_{EN}) vs Temperature

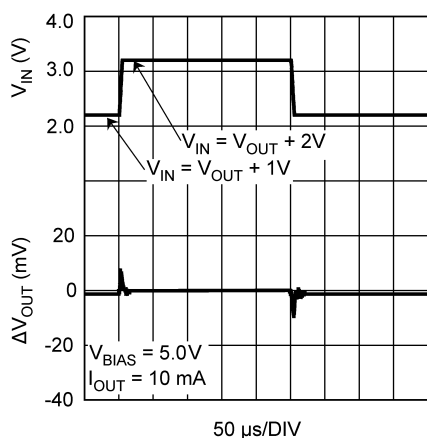

Figure 15. V_{IN} Line Transient Response

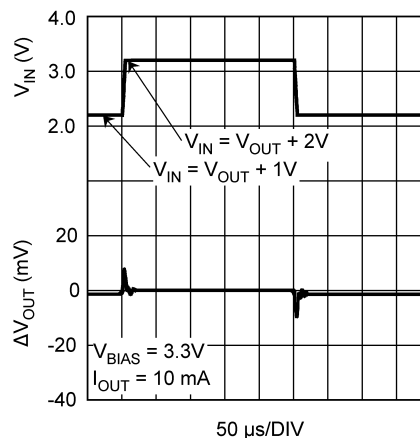

Figure 16. V_{IN} Line Transient Response

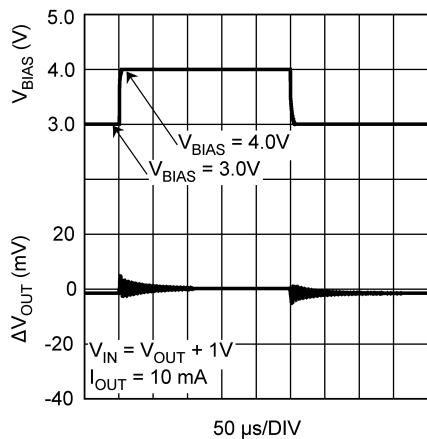

Figure 17. V_{BIAS} Line Transient Response

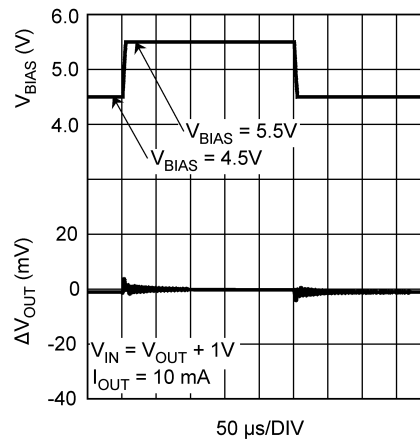

Figure 18. V_{BIAS} Line Transient Response

LP38853

SNVS335F – DECEMBER 2006 – REVISED NOVEMBER 2016

www.ti.com

Typical Characteristics (continued)

Refer to the [Simplified Schematic](#). Unless otherwise specified: $T_J = 25^\circ\text{C}$, $R_1 = 1.4\text{ k}\Omega$, $R_2 = 1\text{ k}\Omega$, $C_{FF} = 0.01\text{ }\mu\text{F}$, $V_{IN} = V_{OUT(NOM)} + 1\text{ V}$, $V_{BIAS} = 3\text{ V}$, $I_{OUT} = 10\text{ mA}$, $C_{IN} = 10\text{-}\mu\text{F ceramic}$, $C_{OUT} = 10\text{-}\mu\text{F ceramic}$, $C_{BIAS} = 1\text{-}\mu\text{F ceramic}$, $C_{SS} = \text{open}$.

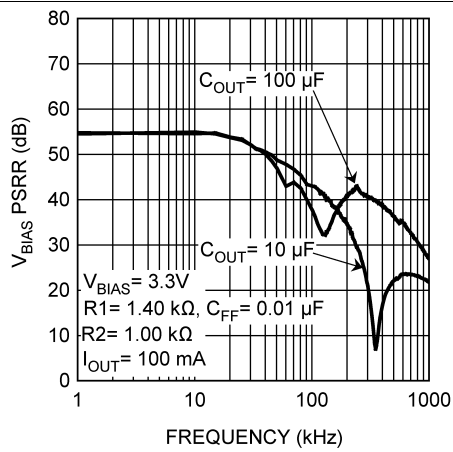
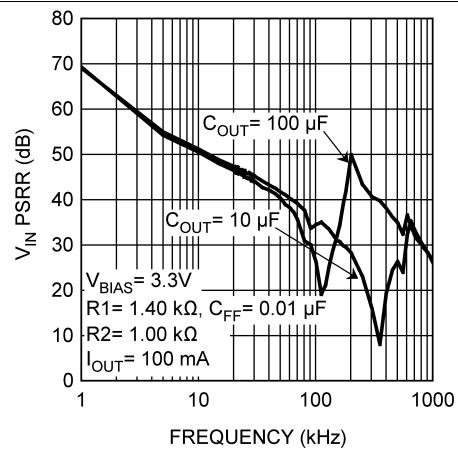
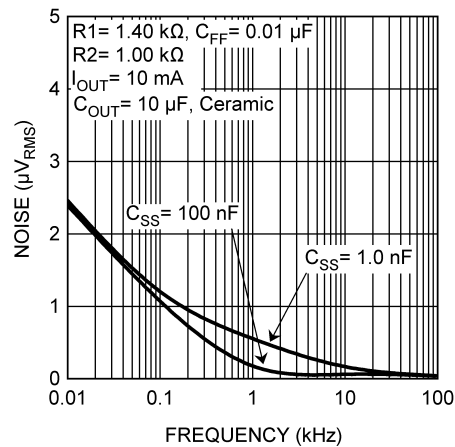
**Figure 19. V_{BIAS} PSRR****Figure 20. V_{IN} PSRR****Figure 21. Output Noise**

7 Detailed Description

7.1 Overview

The LP38853 is a high-current, low-dropout, fast-response linear regulator capable of sourcing a 3-A load with only 240-mV dropout. This device operates from two input voltages: V_{BIAS} provides voltage to internal circuit, while V_{IN} is the input voltage supplying power to load. The use of an external bias rail allows the part to operate from ultra low V_{IN} voltages. The fast transient response of this device makes it suitable for powering DSP, microcontroller cores, and post regulators.

7.2 Functional Block Diagram

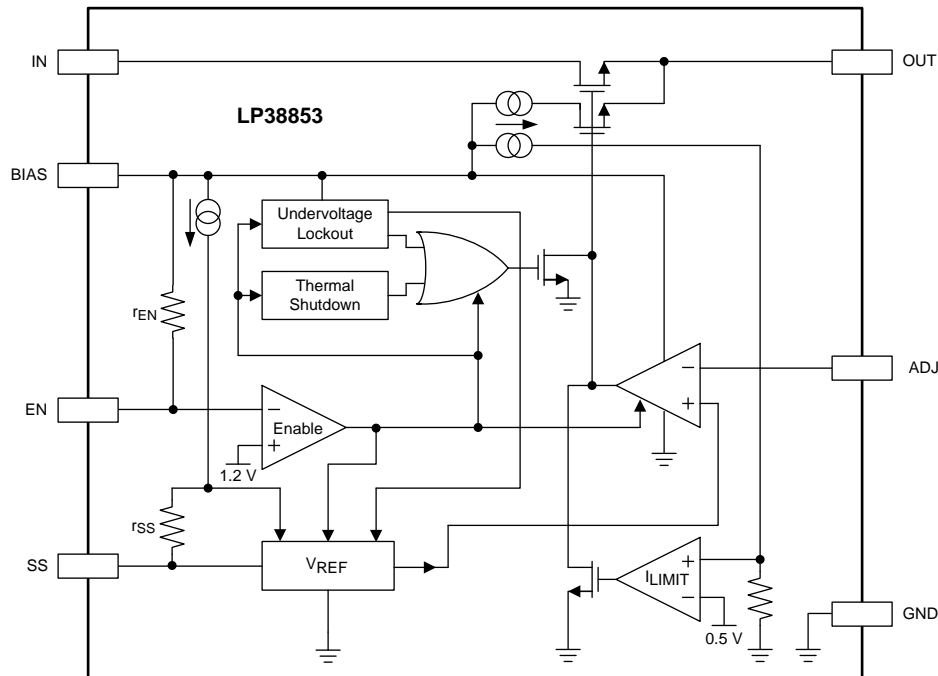

7.3 Feature Description

7.3.1 Undervoltage Lockout (UVLO)

The bias voltage is monitored by a circuit which prevents the device from functioning when the bias voltage is below the UVLO threshold of approximately 2.45 V.

As the bias voltage rises above the UVLO threshold the device control circuitry becomes active. There is approximately 150 mV of hysteresis built into the UVLO threshold to provide noise immunity.

When the bias voltage is between the UVLO threshold and the minimum operating rating value of 3 V the device is functional, but the operating parameters are not be within the specified limits.

7.3.2 Supply Sequencing

There is no requirement for the order that V_{IN} or V_{BIAS} are applied or removed.

One practical limitation is that the soft-start circuit starts charging C_{SS} when both V_{BIAS} rises above the UVLO threshold and the EN pin is above the $V_{EN(ON)}$ threshold. If the application of V_{IN} is delayed beyond this point the benefits of soft start are compromised.

In any case, the output voltage cannot be ensured until both V_{IN} and V_{BIAS} are within the range of specified operating values.

If used in a dual-supply system where the regulator output load is returned to a negative supply, the output pin must be diode clamped to ground. A Schottky diode is recommended for this diode clamp.

LP38853

SNVS335F – DECEMBER 2006 – REVISED NOVEMBER 2016

www.ti.com

Feature Description (continued)**7.3.3 Reverse Voltage**

A reverse voltage condition exists when the voltage at the output pin is higher than the voltage at the IN pin. Typically this happens when V_{IN} is abruptly taken low and C_{OUT} continues to hold a sufficient charge such that the input to output voltage becomes reversed.

The NMOS pass element, by design, contains no body diode. This means that, as long as the gate of the pass element is not driven, there is no reverse current flow through the pass element during a reverse voltage event. The gate of the pass element is not driven when V_{BIAS} is below the UVLO threshold, or when the EN pin is held low.

When V_{BIAS} is above the UVLO threshold, and the EN pin is above the $V_{EN(ON)}$ threshold, the control circuitry is active and attempts to regulate the output voltage. Because the input voltage is less than the output voltage the control circuit drives the gate of the pass element to the full V_{BIAS} potential when the output voltage begins to fall. In this condition, reverse current flows from the OUT pin to the IN pin, limited only by the $R_{DS(ON)}$ of the pass element and the output-to-input voltage differential. Discharging an output capacitor up to 1000 μF in this manner does not damage the device as the current rapidly decays. However, continuous reverse current must be avoided.

7.3.4 Soft-Start

The LP38853 incorporates a soft-start function that reduces the start-up current surge into the output capacitor (C_{OUT}) by allowing V_{OUT} to rise slowly to the final value. This is accomplished by controlling V_{REF} at the SS pin. The soft-start timing capacitor (C_{SS}) is internally held to ground until both V_{BIAS} rises above the UVLO threshold and the EN pin is higher than the $V_{EN(ON)}$ threshold.

V_{REF} rises at an RC rate defined by the internal resistance of the SS pin (r_{SS}) and the external capacitor connected to the SS pin. This allows the output voltage to rise in a controlled manner until steady-state regulation is achieved. Typically, five time constants are recommended to assure that the output voltage is sufficiently close to the final steady-state value. During the soft-start time the output current can rise to the built-in current limit.

$$\text{Soft-Start Time} = C_{SS} \times r_{SS} \times 5 \quad (1)$$

Because the V_{OUT} rise is exponential, not linear, the in-rush current peaks during the first time constant (τ), and V_{OUT} requires four additional time constants (4τ) to reach the final value (5τ).

After achieving normal operation, if either V_{BIAS} fall below the ULVO threshold, or the EN pin fall below the $V_{EN(OFF)}$ threshold, the device output is disabled, and the soft-start capacitor (C_{SS}) discharge circuit becomes active. The C_{SS} discharge circuit remains active until V_{BIAS} falls to 500 mV (typical). When V_{BIAS} falls below 500 mV (typical), the C_{SS} discharge circuit ceases to function due to a lack of sufficient biasing to the control circuitry.

Because V_{REF} appears on the SS pin, any leakage through C_{SS} causes V_{REF} to fall, thus affecting V_{OUT} . A leakage of 50 nA (about 10 M Ω) through C_{SS} causes V_{OUT} to be approximately 0.1% lower than nominal, while a leakage of 500 nA (about 1 M Ω) causes V_{OUT} to be approximately 1% lower than nominal. Typical ceramic capacitors have a factor of 10 \times difference in leakage between 25 $^{\circ}\text{C}$ and 85 $^{\circ}\text{C}$, so the maximum ambient temperature must be included in the capacitor selection process.

Typical C_{SS} values are in the range of 1 nF to 100 nF, providing typical soft-start times in the range of 70 μs to 7 ms (5τ). Values less than 1 nF may be used, but the soft-start effect will be minimal. Values larger than 100 nF provide soft start but may not be fully discharged if V_{BIAS} falls from the UVLVO threshold to less than 500 mV in less than 100 μs .

Figure 22 shows the relationship between the C_{OUT} value and a typical C_{SS} value.

Feature Description (continued)

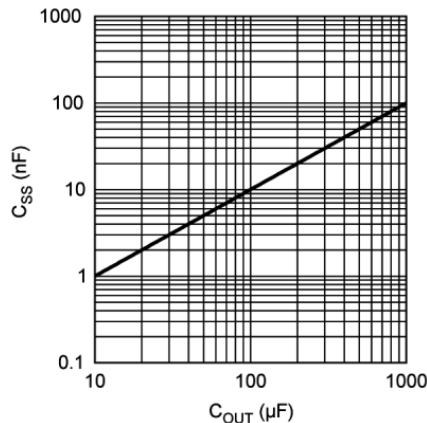

Figure 22. Typical C_{SS} vs C_{OUT} Values

The C_{SS} capacitor must be connected to a clean ground path back to the device ground pin. No components, other than C_{SS}, must be connected to the SS pin, as there could be adverse effects to V_{OUT}.

If the soft-start function is not needed the SS pin must be left open, although some minimal capacitance value is always recommended.

7.3.5 Setting The Output Voltage

The output voltage is set using the external resistive divider R1 and R2 (see Figure 23). The output voltage is given by Equation 2:

$$V_{OUT} = V_{ADJ} \times \left(1 + \left(\frac{R1}{R2} \right) \right) \quad (2)$$

The resistors used for R1 and R2 must be high quality, tight tolerance, and with matching temperature coefficients. It is important to remember that, although the value of V_{ADJ} is specified, the use of low-quality resistors for R1 and R2 can easily produce a V_{OUT} value that is unacceptable.

It is recommended that the values selected for R1 and R2 are such that the parallel value is less than 10 kΩ. This is to prevent internal parasitic capacitances on the ADJ pin from interfering with the F_Z pole set by R1 and C_{FF}.

$$\left(\frac{R1 \times R2}{R1 + R2} \right) \leq 10 \text{ k}\Omega \quad (3)$$

Table 1 lists some suggested, best fit, standard ±1% resistor values for R1 and R2, and a standard ±10% capacitor values for C_{FF}, for a range of V_{OUT} values. Other values of R1, R2, and C_{FF} are available that give similar results.

LP38853

SNVS335F – DECEMBER 2006 – REVISED NOVEMBER 2016

www.ti.com

Table 1. Suggested Resistor Values

V _{OUT}	R1	R2	C _{FF}	F _Z
0.8 V	1.07 kΩ	1.78 kΩ	12 nF	12.4 kHz
0.9 V	1.50 kΩ	1.87 kΩ	8.2 nF	12.9 kHz
1 V	1.00 kΩ	1.00 kΩ	12 nF	13.3 kHz
1.1 V	1.65 kΩ	1.37 kΩ	8.2 nF	11.8 kHz
1.2 V	1.40 kΩ	1.00 kΩ	10 nF	11.4 kHz
1.3 V	1.15 kΩ	715 Ω	12 nF	11.5 kHz
1.4 V	1.07 kΩ	590 Ω	12 nF	12.4 kHz
1.5 V	2.00 kΩ	1.00 kΩ	6.8 nF	11.7 kHz
1.6 V	1.65 kΩ	750 Ω	8.2 nF	11.8 kHz
1.7 V	2.55 kΩ	1.07 kΩ	5.6 nF	11.1 kHz
1.8 V	2.94 kΩ	1.13 kΩ	4.7 nF	11.5 kHz

Refer to the TI Application Note AN-1378 *Method for Calculating Output Voltage Tolerances in Adjustable Regulators* (SNVA112) for additional information on how resistor tolerances affect the calculated V_{OUT} value.

7.3.6 Enable (EN) Operation

The EN pin provides a mechanism to enable, or disable, the regulator output stage. The EN pin has an internal pullup, through a typical 180-kΩ resistor, to V_{BIAS}. The EN pin can be left open or connected V_{BIAS} if the enable function is not needed.

7.4 Device Functional Modes**7.4.1 Input Voltage**

The input voltage (V_{IN}) is the high-current external voltage rail that is regulated down to a lower voltage, which is applied to the load. The input voltage must be at least V_{OUT} + V_{DO}, and no higher than whatever value is used for V_{BIAS}.

For applications where V_{BIAS} is higher than 4.5 V, V_{IN} must be no greater than 4.5 V, otherwise output voltage accuracy may be affected.

7.4.2 Bias Voltage

The bias voltage (V_{BIAS}) is a low-current external voltage rail required to bias the control circuitry and provide gate drive for the N-FET pass transistor. When V_{OUT} is set to 1.2 V, or less, V_{BIAS} may be anywhere in the operating range of 3 V to 5.5 V. If V_{OUT} is set higher than 1.2 V, V_{BIAS} must be between 4.5 V and 5.5 V to ensure proper operation of the device.

7.4.3 Enable Operation

If the EN pin is actively driven, pulling the EN pin above the V_{EN} threshold of 1.25 V (typical) turns on the regulator output; pulling the EN pin below the V_{EN} threshold turns off the regulator output. There is approximately 100 mV of hysteresis built into the enable threshold provide noise immunity.

If the enable function is not needed the EN pin must be left open, or connected directly to V_{BIAS}. If the EN pin is left open, stray capacitance on this pin must be minimized; otherwise, the output turnon is delayed while the stray capacitance is charged through the internal resistance (r_{EN}).

8 Application and Implementation

NOTE

Information in the following applications sections is not part of the TI component specification, and TI does not warrant its accuracy or completeness. TI's customers are responsible for determining suitability of components for their purposes. Customers should validate and test their design implementation to confirm system functionality.

8.1 Application Information

The typical applications of the LP38853 include DSP supplies, microcontroller supplies, and post regulators. [Figure 23](#) shows the typical application circuit for LP38853.

8.2 Typical Application

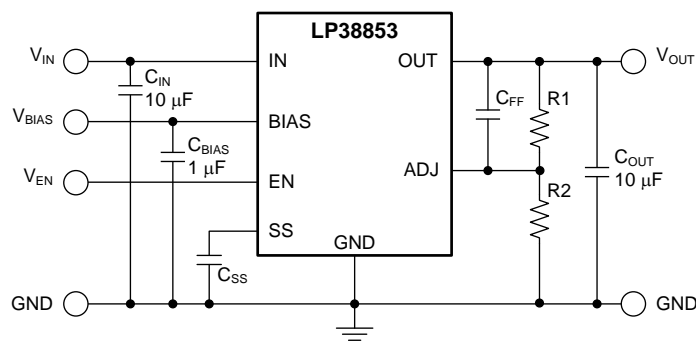

Figure 23. LP38853 Typical Application

8.2.1 Design Requirements

For typical linear regulator applications, use the parameters listed in [Table 2](#).

Table 2. Design Parameters

DESIGN PARAMETER	EXAMPLE VALUE
Input voltage	1.8 V
Output voltage	0.8 V
Output current	3 A

8.2.2 Detailed Design Procedure

8.2.2.1 External Capacitors

To assure regulator stability, input and output capacitors are required as shown in the [Figure 23](#).

8.2.2.1.1 Input Capacitor

The input capacitor must be at least 10 µF, but can be increased without limit. Its purpose is to provide a low source impedance for the regulator input. A ceramic capacitor, X5R or X7R, is recommended.

Tantalum capacitors may also be used at the input pin. There is no specific equivalent series resistance (ESR) limitation on the input capacitor (the lower, the better).

Aluminum electrolytic capacitors can be used, but are not recommended as their ESR increases very quickly at cold temperatures. They are not recommended for any application where the ambient temperature falls below 0°C.

LP38853

SNVS335F – DECEMBER 2006 – REVISED NOVEMBER 2016

www.ti.com

8.2.2.1.2 Output Capacitor

A minimum output capacitance of 10- μ F ceramic is required for stability. The amount of output capacitance can be increased without limit. The output capacitor must be located less than 1 cm from the OUT pin of the device and returned to the device ground pin with a clean analog ground.

Only high-quality ceramic types such as X5R or X7R must be used, as the Z5U and Y5F types do not provide sufficient capacitance over temperature.

Tantalum capacitors also provide stable operation across the entire operating temperature range. However, the effects of ESR may provide variations in the output voltage during fast load transients. Using the minimum recommended 10- μ F ceramic capacitor at the output allows unlimited capacitance, tantalum or aluminum, to be added in parallel.

8.2.2.1.3 Bias Capacitor

The capacitor on the bias pin must be at least 1 μ F and can be any good-quality capacitor (ceramic is recommended).

8.2.2.1.4 Set The Output Voltage

According to [Table 1](#), R1 is set to 1.07 k Ω , R2 is set to 1.78 k Ω .

8.2.2.1.5 Feed Forward Capacitor, C_{FF}

When using a ceramic capacitor for C_{OUT}, the typical ESR value may be too small to provide any meaningful positive phase compensation, F_Z, to offset the internal negative phase shifts in the gain loop (see [Figure 23](#) and [Equation 4](#)).

$$F_Z = (1 / (2 \times \pi \times C_{OUT} \times ESR)) \quad (4)$$

A capacitor placed across the gain resistor R1 provides additional phase margin to improve load transient response of the device. This capacitor, C_{FF}, in parallel with R1, forms a zero in the loop response given by [Equation 5](#):

$$F_Z = (1 / (2 \times \pi \times C_{FF} \times R1)) \quad (5)$$

For optimum load transient response select C_{FF} so the zero frequency, F_Z, falls between 10 kHz and 15 kHz as shown in [Equation 6](#):

$$(C_{FF} = (1 / (2 \times \pi \times R1 \times F_Z)) \quad (6)$$

The phase lead provided by C_{FF} diminishes as the DC gain approaches unity, or V_{OUT} approaches V_{ADJ}. This is because C_{FF} also forms a pole with a frequency shown in [Equation 7](#):

$$F_P = (1 / (2 \times \pi \times C_{FF} \times (R1 \parallel R2))) \quad (7)$$

NOTE

It is important to note that at higher output voltages, where R1 is much larger than R2, the pole and zero are far apart in frequency. At lower output voltages the frequency of the pole and the zero move closer together. The phase lead provided from C_{FF} diminishes quickly as the output voltage is reduced, and has no effect when V_{OUT} = V_{ADJ}. For this reason, relying on this compensation technique alone is adequate only for higher output voltages. For the LP38853, the practical minimum V_{OUT} is 0.8 V when a ceramic capacitor is used for C_{OUT}.

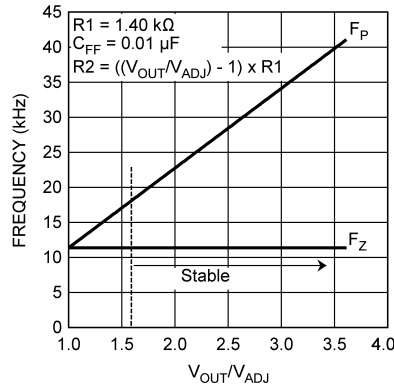
Figure 24. F_{ZERO} and F_{POLE} vs Gain

8.2.2.2 Power Dissipation and Heat Sinking

Additional copper area for heat sinking may be required, depending on the maximum device dissipation (P_D) and the maximum anticipated ambient temperature (T_A) for the device. Under all possible conditions, the junction temperature must be within the range specified under operating conditions.

The total power dissipation of the device is the sum of three different points of dissipation in the device.

The first part is the power that is dissipated in the NMOS pass element and can be determined with [Equation 8](#):

$$P_{D(PASS)} = (V_{IN} - V_{OUT}) \times I_{OUT} \quad (8)$$

The second part is the power that is dissipated in the bias and control circuitry and can be determined with [Equation 9](#):

$$P_{D(BIAS)} = V_{BIAS} \times I_{GND(BIAS)}$$

where

- $I_{GND(BIAS)}$ is the portion of the operating ground current of the device that is related to V_{BIAS} . (9)

The third part is the power that is dissipated in portions of the output stage circuitry and can be determined with [Equation 10](#):

$$P_{D(IN)} = V_{IN} \times I_{GND(IN)}$$

where

- $I_{GND(IN)}$ is the portion of the operating ground current of the device that is related to V_{IN} . (10)

The total power dissipation is shown by [Equation 11](#):

$$P_D = P_{D(PASS)} + P_{D(BIAS)} + P_{D(IN)} \quad (11)$$

The maximum allowable junction temperature rise (ΔT_J) depends on the maximum anticipated ambient temperature ($T_{A(MAX)}$) for the application, and the maximum allowable operating junction temperature ($T_{J(MAX)}$)(see [Equation 12](#)):

$$\Delta T_J = T_{J(MAX)} - T_{A(MAX)} \quad (12)$$

The maximum allowable value for junction-to-ambient thermal resistance, $R_{\theta JA}$, can be calculated using [Equation 13](#):

$$R_{\theta JA} \leq \frac{\Delta T_J}{P_D} \quad (13)$$

LP38853

SNVS335F – DECEMBER 2006 – REVISED NOVEMBER 2016

www.ti.com

8.2.3 Application Curves

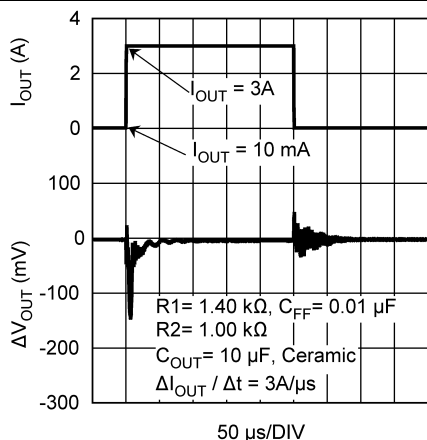

Figure 25. Load Transient Response

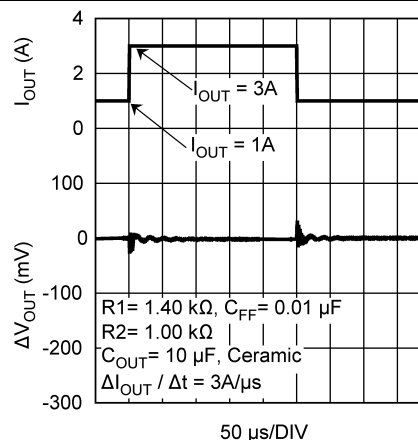

Figure 26. Load Transient Response

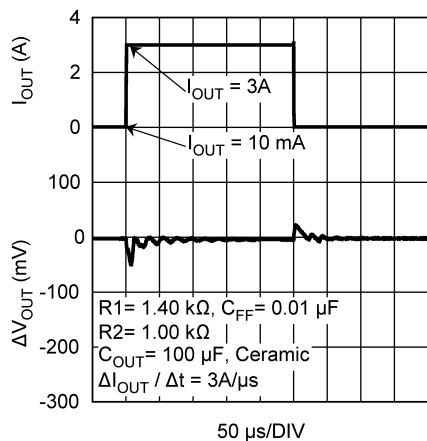

Figure 27. Load Transient Response

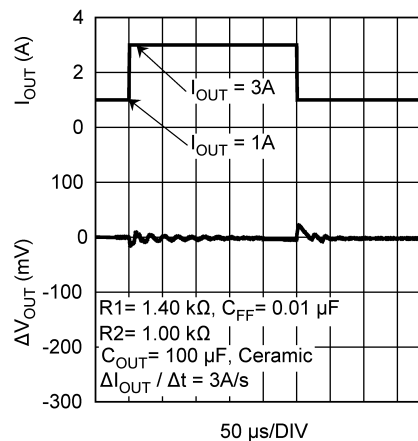

Figure 28. Load Transient Response

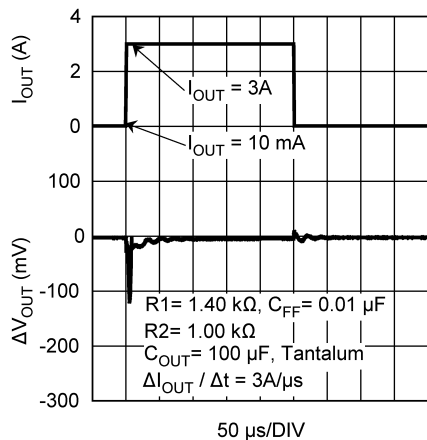

Figure 29. Load Transient Response

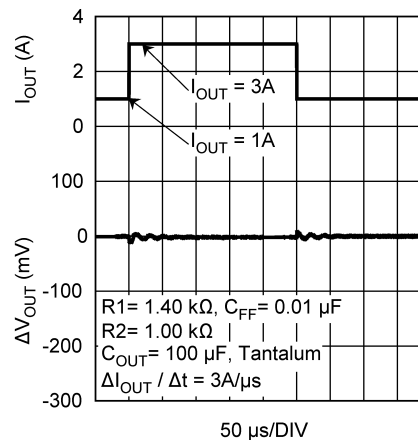

Figure 30. Load Transient Response

9 Power Supply Recommendations

The LP38853 device is designed to operate from an input voltage supply range from 3 V and 5.5 V. The input voltage range provides adequate headroom in order for the device to have a regulated output. This input supply must be well regulated. An input capacitor of at least 10 μF is required.

10 Layout

10.1 Layout Guidelines

For best overall performance, place all circuit components on the same side of the circuit board and as near as practical to the respective LDO pin connections. Place ground return connections to the input and output capacitor, and to the LDO ground pin as close as possible to each other, connected by a wide, component side, copper surface. The use of vias and long traces to create LDO circuit connections is strongly discouraged and negatively affects system performance. This grounding and layout scheme minimizes inductive parasitic, and thereby reduces load current transients, minimizes noise, and increases circuit stability.

A ground reference plane is also recommended and is either embedded in the PCB itself or located on the bottom side of the PCB opposite the components. This reference plane serves to assure accuracy of the output voltage, shield noise, and behaves similarly to a thermal plane to spread heat from the LDO device when connected to the PowerPAD. In most applications, this ground plane is necessary to meet thermal requirements.

10.2 Layout Examples

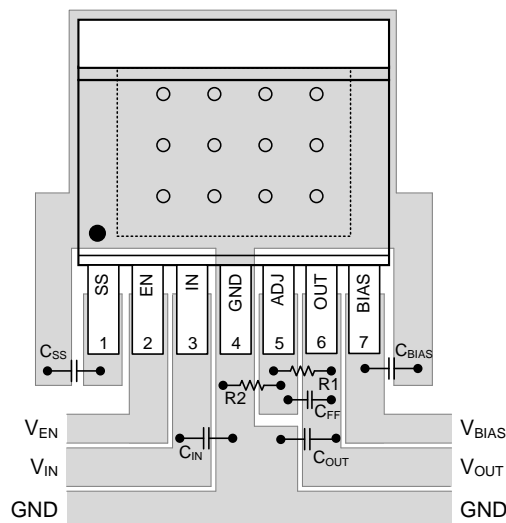

Figure 31. LP38853 DDPAK/TO-263 and TO-220 Layout Example

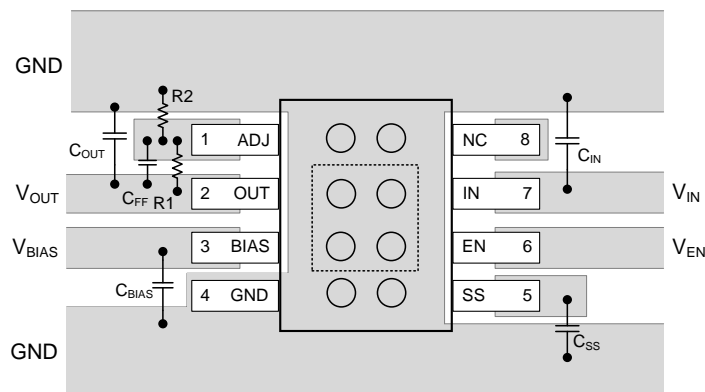

Figure 32. LP38853 SO PowerPAD Layout Example

LP38853

SNVS335F – DECEMBER 2006 – REVISED NOVEMBER 2016

www.ti.com

11 Device and Documentation Support

11.1 Documentation Support

11.1.1 Related Documentation

For additional information, see the following:

[AN-1378 Method for Calculating Output Voltage Tolerances in Adjustable Regulators](#)

11.2 Community Resources

The following links connect to TI community resources. Linked contents are provided "AS IS" by the respective contributors. They do not constitute TI specifications and do not necessarily reflect TI's views; see TI's [Terms of Use](#).

TI E2E™ Online Community *TI's Engineer-to-Engineer (E2E) Community*. Created to foster collaboration among engineers. At e2e.ti.com, you can ask questions, share knowledge, explore ideas and help solve problems with fellow engineers.

Design Support *TI's Design Support* Quickly find helpful E2E forums along with design support tools and contact information for technical support.

11.3 Trademarks

PowerPAD, E2E are trademarks of Texas Instruments.
All other trademarks are the property of their respective owners.

11.4 Electrostatic Discharge Caution



These devices have limited built-in ESD protection. The leads should be shorted together or the device placed in conductive foam during storage or handling to prevent electrostatic damage to the MOS gates.

11.5 Glossary

[SLYZ022](#) — *TI Glossary*.

This glossary lists and explains terms, acronyms, and definitions.

12 Mechanical, Packaging, and Orderable Information

The following pages include mechanical, packaging, and orderable information. This information is the most current data available for the designated devices. This data is subject to change without notice and revision of this document. For browser-based versions of this data sheet, refer to the left-hand navigation.

PACKAGING INFORMATION

Orderable part number	Status (1)	Material type (2)	Package Pins	Package qty Carrier	RoHS (3)	Lead finish/ Ball material (4)	MSL rating/ Peak reflow (5)	Op temp (°C)	Part marking (6)
LP38853MR-ADJ/NOPB	Active	Production	SO PowerPAD (DDA) 8	95 TUBE	Yes	SN	Level-3-260C-168 HR	-40 to 125	L38853 MRADJ
LP38853MR-ADJ/NOPB.A	Active	Production	SO PowerPAD (DDA) 8	95 TUBE	Yes	SN	Level-3-260C-168 HR	-40 to 125	L38853 MRADJ
LP38853MRX-ADJ/NO.A	Active	Production	SO PowerPAD (DDA) 8	2500 LARGE T&R	Yes	SN	Level-3-260C-168 HR	-40 to 125	L38853 MRADJ
LP38853MRX-ADJ/NOPB	Active	Production	SO PowerPAD (DDA) 8	2500 LARGE T&R	Yes	SN	Level-3-260C-168 HR	-40 to 125	L38853 MRADJ
LP38853S-ADJ/NOPB	Active	Production	DDPAK/TO-263 (KTW) 7	45 TUBE	ROHS Exempt	SN	Level-3-245C-168 HR	-40 to 125	LP38853S ADJ
LP38853S-ADJ/NOPB.A	Active	Production	DDPAK/TO-263 (KTW) 7	45 TUBE	ROHS Exempt	SN	Level-3-245C-168 HR	-40 to 125	LP38853S ADJ
LP38853SX-ADJ/NOPB	Active	Production	DDPAK/TO-263 (KTW) 7	500 LARGE T&R	ROHS Exempt	SN	Level-3-245C-168 HR	-40 to 125	LP38853S ADJ
LP38853SX-ADJ/NOPB.A	Active	Production	DDPAK/TO-263 (KTW) 7	500 LARGE T&R	ROHS Exempt	SN	Level-3-245C-168 HR	-40 to 125	LP38853S ADJ
LP38853T-ADJ/NOPB	Active	Production	TO-220 (NDZ) 7	45 TUBE	Yes	SN	Level-1-NA-UNLIM	-40 to 125	LP38853T ADJ
LP38853T-ADJ/NOPB.A	Active	Production	TO-220 (NDZ) 7	45 TUBE	Yes	SN	Level-1-NA-UNLIM	-40 to 125	LP38853T ADJ

(1) **Status:** For more details on status, see our [product life cycle](#).

(2) **Material type:** When designated, preproduction parts are prototypes/experimental devices, and are not yet approved or released for full production. Testing and final process, including without limitation quality assurance, reliability performance testing, and/or process qualification, may not yet be complete, and this item is subject to further changes or possible discontinuation. If available for ordering, purchases will be subject to an additional waiver at checkout, and are intended for early internal evaluation purposes only. These items are sold without warranties of any kind.

(3) **RoHS values:** Yes, No, RoHS Exempt. See the [TI RoHS Statement](#) for additional information and value definition.

(4) **Lead finish/Ball material:** Parts may have multiple material finish options. Finish options are separated by a vertical ruled line. Lead finish/Ball material values may wrap to two lines if the finish value exceeds the maximum column width.

(5) **MSL rating/Peak reflow:** The moisture sensitivity level ratings and peak solder (reflow) temperatures. In the event that a part has multiple moisture sensitivity ratings, only the lowest level per JEDEC standards is shown. Refer to the shipping label for the actual reflow temperature that will be used to mount the part to the printed circuit board.

(6) **Part marking:** There may be an additional marking, which relates to the logo, the lot trace code information, or the environmental category of the part.

Multiple part markings will be inside parentheses. Only one part marking contained in parentheses and separated by a "~" will appear on a part. If a line is indented then it is a continuation of the previous line and the two combined represent the entire part marking for that device.

Important Information and Disclaimer:The information provided on this page represents TI's knowledge and belief as of the date that it is provided. TI bases its knowledge and belief on information provided by third parties, and makes no representation or warranty as to the accuracy of such information. Efforts are underway to better integrate information from third parties. TI has taken and continues to take reasonable steps to provide representative and accurate information but may not have conducted destructive testing or chemical analysis on incoming materials and chemicals. TI and TI suppliers consider certain information to be proprietary, and thus CAS numbers and other limited information may not be available for release.

In no event shall TI's liability arising out of such information exceed the total purchase price of the TI part(s) at issue in this document sold by TI to Customer on an annual basis.

TAPE AND REEL INFORMATION

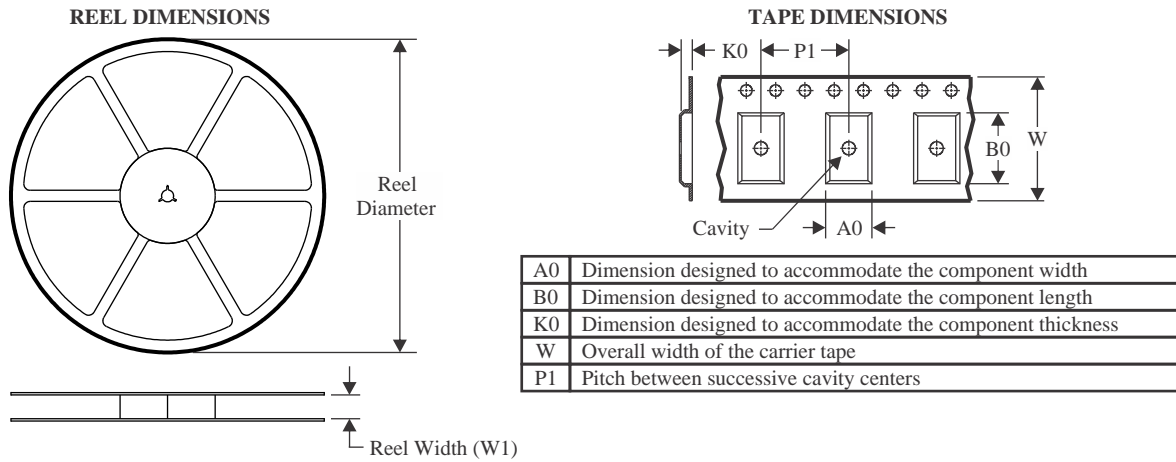

QUADRANT ASSIGNMENTS FOR PIN 1 ORIENTATION IN TAPE

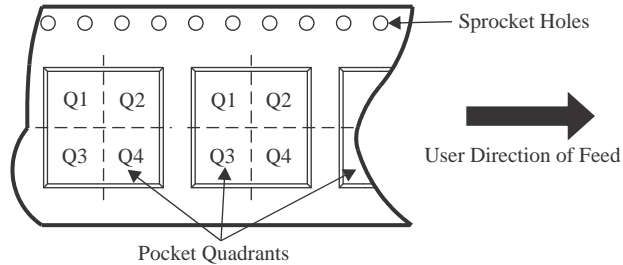

*All dimensions are nominal

Device	Package Type	Package Drawing	Pins	SPQ	Reel Diameter (mm)	Reel Width W1 (mm)	A0 (mm)	B0 (mm)	K0 (mm)	P1 (mm)	W (mm)	Pin1 Quadrant
LP38853MRX-ADJ/NOPB	SO PowerPAD	DDA	8	2500	330.0	12.4	6.5	5.4	2.0	8.0	12.0	Q1
LP38853SX-ADJ/NOPB	DDPAK/ TO-263	KTW	7	500	330.0	24.4	10.75	14.85	5.0	16.0	24.0	Q2

TAPE AND REEL BOX DIMENSIONS

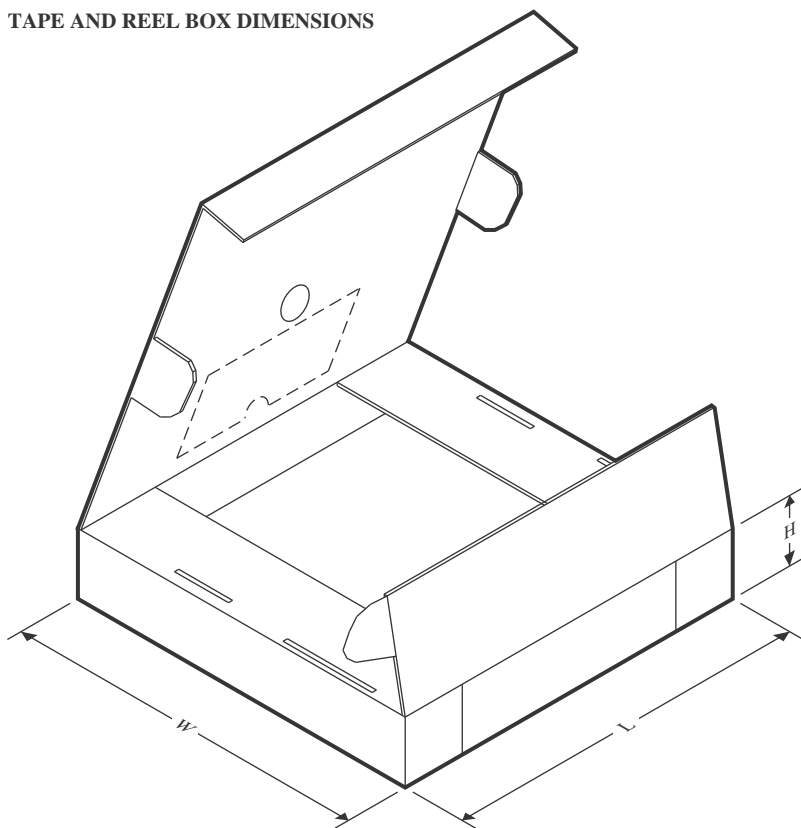

*All dimensions are nominal

Device	Package Type	Package Drawing	Pins	SPQ	Length (mm)	Width (mm)	Height (mm)
LP38853MRX-ADJ/NOPB	SO PowerPAD	DDA	8	2500	356.0	356.0	36.0
LP38853SX-ADJ/NOPB	DDPAK/TO-263	KTW	7	500	356.0	356.0	45.0

TUBE

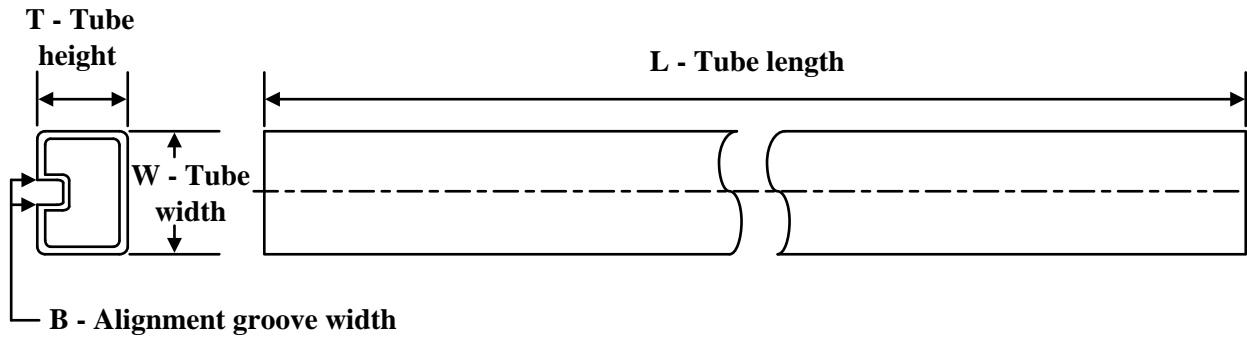

*All dimensions are nominal

Device	Package Name	Package Type	Pins	SPQ	L (mm)	W (mm)	T (μm)	B (mm)
LP38853MR-ADJ/NOPB	DDA	HSOIC	8	95	495	8	4064	3.05
LP38853MR-ADJ/NOPB.A	DDA	HSOIC	8	95	495	8	4064	3.05
LP38853S-ADJ/NOPB	KTW	TO-263	7	45	502	25	8204.2	9.19
LP38853S-ADJ/NOPB.A	KTW	TO-263	7	45	502	25	8204.2	9.19
LP38853T-ADJ/NOPB	NDZ	TO-220	7	45	502	30	30048.2	10.74
LP38853T-ADJ/NOPB.A	NDZ	TO-220	7	45	502	30	30048.2	10.74

EXAMPLE STENCIL DESIGN

DDA0008A

PowerPAD™ SOIC - 1.7 mm max height

PLASTIC SMALL OUTLINE

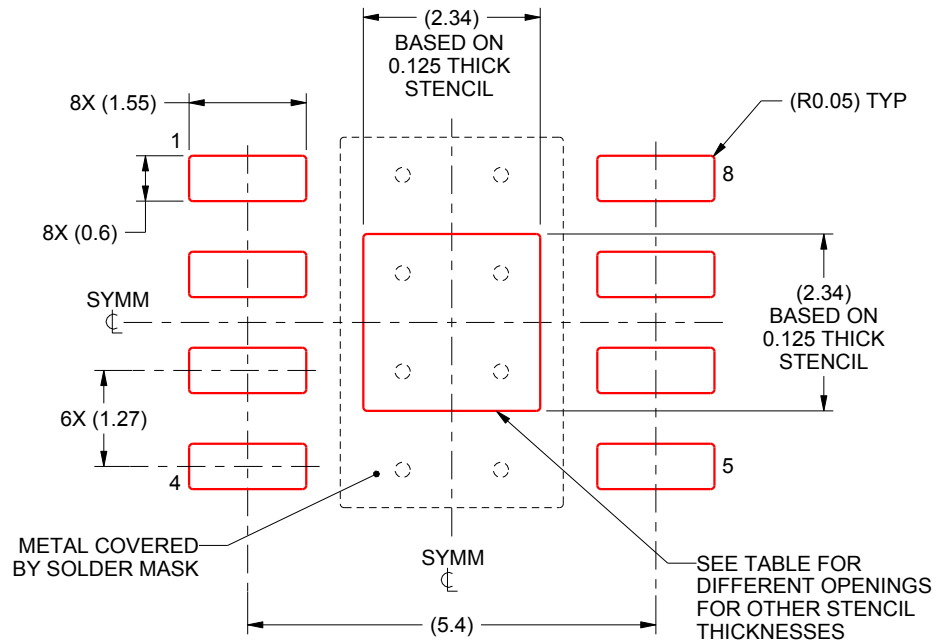

SOLDER PASTE EXAMPLE
 EXPOSED PAD
 100% PRINTED SOLDER COVERAGE BY AREA
 SCALE:10X

STENCIL THICKNESS	SOLDER STENCIL OPENING
0.1	2.62 X 2.62
0.125	2.34 X 2.34 (SHOWN)
0.150	2.14 X 2.14
0.175	1.98 X 1.98

4218825/A 05/2016

NOTES: (continued)

11. Laser cutting apertures with trapezoidal walls and rounded corners may offer better paste release. IPC-7525 may have alternate design recommendations.
12. Board assembly site may have different recommendations for stencil design.

PACKAGE OUTLINE

DDA0008D



PowerPAD™ SOIC - 1.7 mm max height

PLASTIC SMALL OUTLINE

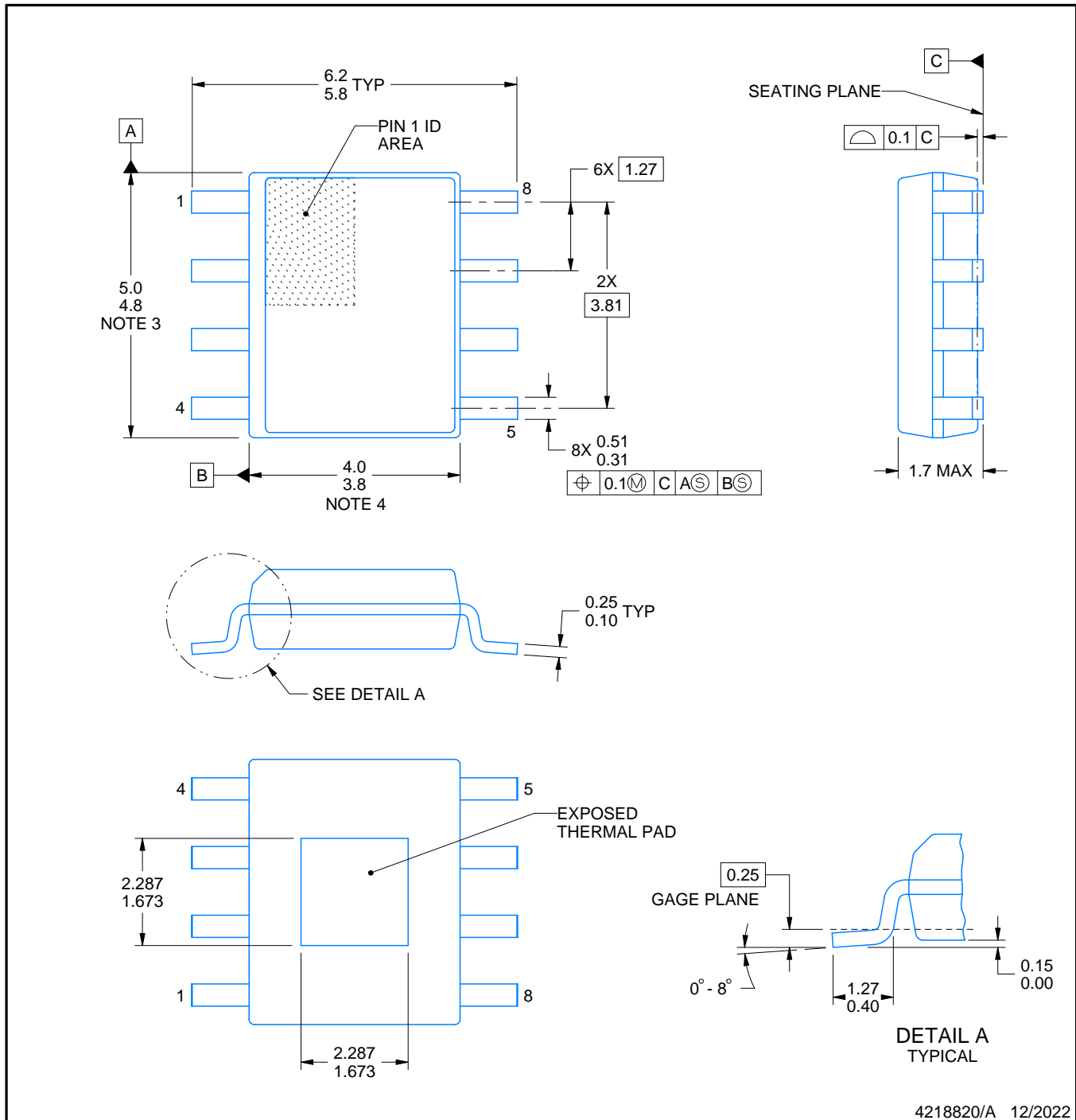

PowerPAD is a trademark of Texas Instruments.

NOTES:

- All linear dimensions are in millimeters. Any dimensions in parenthesis are for reference only. Dimensioning and tolerancing per ASME Y14.5M.
- This drawing is subject to change without notice.
- This dimension does not include mold flash, protrusions, or gate burrs. Mold flash, protrusions, or gate burrs shall not exceed 0.15 mm per side.
- This dimension does not include interlead flash. Interlead flash shall not exceed 0.25 mm per side.
- Reference JEDEC registration MS-012, variation BA.

EXAMPLE STENCIL DESIGN**DDA0008D****PowerPAD™ SOIC - 1.7 mm max height**

PLASTIC SMALL OUTLINE

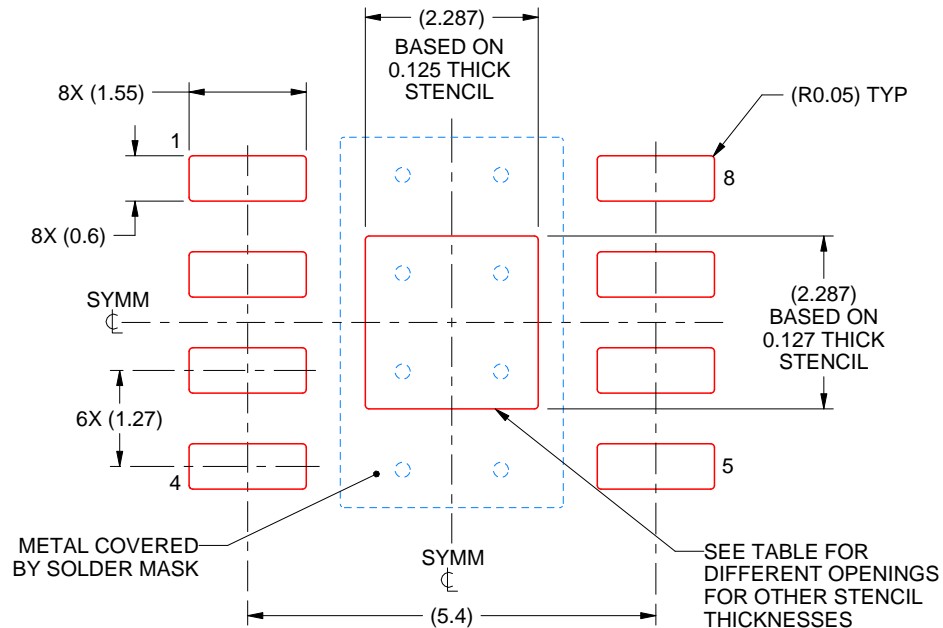

SOLDER PASTE EXAMPLE
EXPOSED PAD
100% PRINTED SOLDER COVERAGE BY AREA
SCALE:10X

STENCIL THICKNESS	SOLDER STENCIL OPENING
0.1	2.557 X 2.557
0.125	2.287 X 2.287 (SHOWN)
0.150	2.088 X 2.088
0.175	1.933 X 1.933

4218820/A 12/2022

NOTES: (continued)

10. Laser cutting apertures with trapezoidal walls and rounded corners may offer better paste release. IPC-7525 may have alternate design recommendations.
11. Board assembly site may have different recommendations for stencil design.

EXAMPLE BOARD LAYOUT

KTW0007A

TO-263 - 5 mm max height

TRANSISTOR OUTLINE

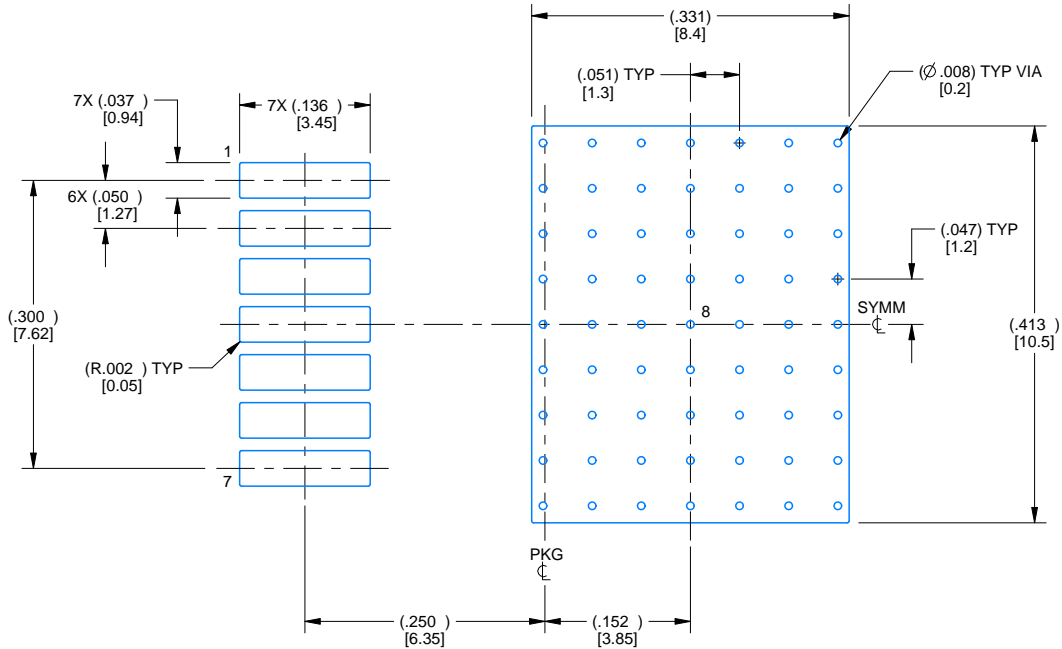

LAND PATTERN EXAMPLE
EXPOSED METAL SHOWN
SCALE: 5X

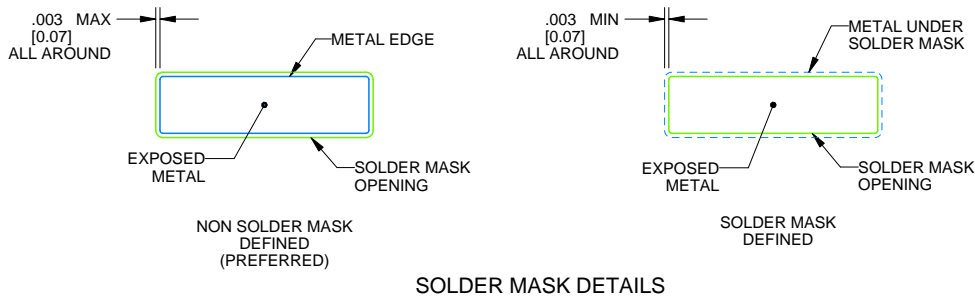

SOLDER MASK DETAILS

4232469/A 11/2025

NOTES: (continued)

8. This package is designed to be soldered to a thermal pad on the board. For more information, see Texas Instruments literature numbers SLMA002(www.ti.com/lit/slm002) and SLMA004 (www.ti.com/lit/slma004).
9. Vias are optional depending on application, refer to device data sheet. It is recommended that vias under paste be filled, plugged or tented.

EXAMPLE STENCIL DESIGN

KTW0007A

TO-263 - 5 mm max height

TRANSISTOR OUTLINE

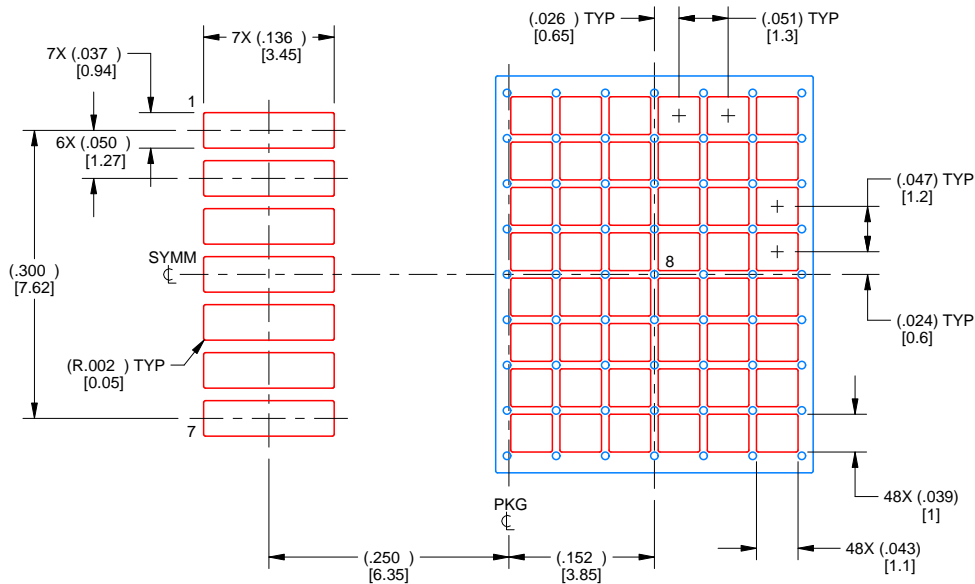

SOLDER PASTE EXAMPLE
 BASED ON 0.125 mm THICK STENCIL
 SCALE: 5X

PRINTED SOLDER COVERAGE BY AREA UNDER PACKAGE
 PAD 8: 60%

4232469/A 11/2025

NOTES: (continued)

10. Laser cutting apertures with trapezoidal walls and rounded corners may offer better paste release. IPC-7525 may have alternate design recommendations.
11. Board assembly site may have different recommendations for stencil design.

IMPORTANT NOTICE AND DISCLAIMER

TI PROVIDES TECHNICAL AND RELIABILITY DATA (INCLUDING DATASHEETS), DESIGN RESOURCES (INCLUDING REFERENCE DESIGNS), APPLICATION OR OTHER DESIGN ADVICE, WEB TOOLS, SAFETY INFORMATION, AND OTHER RESOURCES "AS IS" AND WITH ALL FAULTS, AND DISCLAIMS ALL WARRANTIES, EXPRESS AND IMPLIED, INCLUDING WITHOUT LIMITATION ANY IMPLIED WARRANTIES OF MERCHANTABILITY, FITNESS FOR A PARTICULAR PURPOSE OR NON-INFRINGEMENT OF THIRD PARTY INTELLECTUAL PROPERTY RIGHTS.

These resources are intended for skilled developers designing with TI products. You are solely responsible for (1) selecting the appropriate TI products for your application, (2) designing, validating and testing your application, and (3) ensuring your application meets applicable standards, and any other safety, security, regulatory or other requirements.

These resources are subject to change without notice. TI grants you permission to use these resources only for development of an application that uses the TI products described in the resource. Other reproduction and display of these resources is prohibited. No license is granted to any other TI intellectual property right or to any third party intellectual property right. TI disclaims responsibility for, and you fully indemnify TI and its representatives against any claims, damages, costs, losses, and liabilities arising out of your use of these resources.

TI's products are provided subject to [TI's Terms of Sale](#), [TI's General Quality Guidelines](#), or other applicable terms available either on ti.com or provided in conjunction with such TI products. TI's provision of these resources does not expand or otherwise alter TI's applicable warranties or warranty disclaimers for TI products. Unless TI explicitly designates a product as custom or customer-specified, TI products are standard, catalog, general purpose devices.

TI objects to and rejects any additional or different terms you may propose.

Copyright © 2026, Texas Instruments Incorporated

Last updated 10/2025

OUR CERTIFICATE

DiGi provide top-quality products and perfect service for customer worldwide through standardization, technological innovation and continuous improvement. DiGi through third-party certification, we stricly control the quality of products and services. Welcome your RFQ to

Email: Info@DiGi-Electronics.com



Tel: +00 852-30501935

RFQ Email: Info@DiGi-Electronics.com

DiGi is a global authorized distributor of electronic components.