

THS4501CDR Datasheet

www.digi-electronics.com

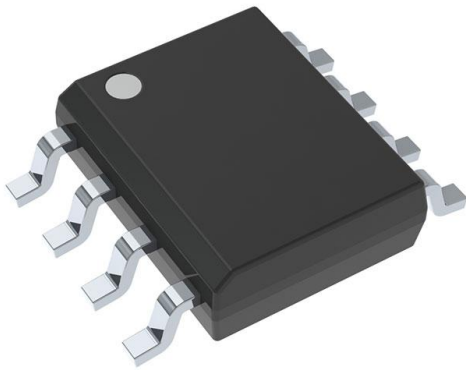

<https://www.DiGi-Electronics.com>

| | |
|------------------------------|--|
| DiGi Electronics Part Number | THS4501CDR-DG |
| Manufacturer | Texas Instruments |
| Manufacturer Product Number | THS4501CDR |
| Description | IC OPAMP DIFF 1 CIRCUIT 8SOIC |
| Detailed Description | Differential Amplifier 1 Circuit Differential 8-SOIC |



Tel: +00 852-30501935

RFQ Email: Info@DiGi-Electronics.com

DiGi is a global authorized distributor of electronic components.

Purchase and inquiry

Manufacturer Product Number:

THS4501CDR

Series:

-

Amplifier Type:

Differential

Output Type:

Differential

Gain Bandwidth Product:

300 MHz

Current - Input Bias:

4 μ A

Current - Supply:

23mA

Voltage - Supply Span (Max):

15 V

Mounting Type:

Surface Mount

Supplier Device Package:

8-SOIC

Manufacturer:

Texas Instruments

Product Status:

Obsolete

Number of Circuits:

1

Slew Rate:

2800V/ μ s

-3db Bandwidth:

370 MHz

Voltage - Input Offset:

4 mV

Voltage - Supply Span (Min):

4.5 V

Operating Temperature:

0°C ~ 70°C

Package / Case:

8-SOIC (0.154", 3.90mm Width)

Base Product Number:

THS450

Environmental & Export classification

RoHS Status:

ROHS3 Compliant

REACH Status:

REACH Unaffected

HTSUS:

8542.33.0001

Moisture Sensitivity Level (MSL):

1 (Unlimited)

ECCN:

EAR99

THS4500
THS4501

www.ti.com

SLOS350F – APRIL 2002 – REVISED OCTOBER 2011

WIDEBAND, LOW-DISTORTION, FULLY DIFFERENTIAL AMPLIFIERS

Check for Samples: [THS4500](#), [THS4501](#)

FEATURES

- Fully Differential Architecture
- Bandwidth: 370 MHz
- Slew Rate: 2800 V/ μ s
- IMD₃: –90 dBc at 30 MHz
- OIP₃: 49 dBm at 30 MHz
- Output Common-Mode Control
- Wide Power-Supply Voltage Range: 5 V, \pm 5 V, 12 V, 15 V
- Input Common-Mode Range Shifted to Include Negative Power-Supply Rail
- Power-Down Capability (THS4500)
- Evaluation Module Available

DESCRIPTION

The THS4500 and THS4501 are high-performance fully differential amplifiers from Texas Instruments. The THS4500, featuring power-down capability, and the THS4501, without power-down capability, set new performance standards for fully differential amplifiers with unsurpassed linearity, supporting 14-bit operation through 40 MHz. Package options include the SOIC-8 and the MSOP-8 with PowerPAD™ for a smaller footprint, enhanced ac performance, and improved thermal dissipation capability.

APPLICATIONS

- High Linearity Analog-to-Digital Converter Pre-amplifier
- Wireless Communication Receiver Chains
- Single-Ended to Differential Conversion
- Differential Line Driver
- Active Filtering of Differential Signals

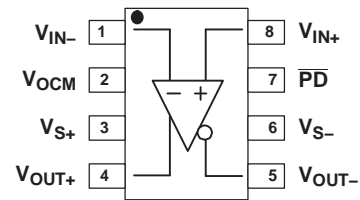

RELATED DEVICES

| DEVICE ⁽¹⁾ | DESCRIPTION |
|---------------------------|---|
| THS4500/1 | 370 MHz, 2800 V/ μ s, V _{ICR} Includes V _{S-} |
| THS4502/3 | 370 MHz, 2800 V/ μ s, Centered V _{ICR} |
| THS4120/1 | 3.3 V, 100 MHz, 43 V/ μ s, 3.7 nV/ $\sqrt{\text{Hz}}$ |
| THS4130/1 | \pm 15 V, 150 MHz, 51 V/ μ s, 1.3 nV/ $\sqrt{\text{Hz}}$ |
| THS4140/1 | \pm 15 V, 160 MHz, 450 V/ μ s, 6.5 nV/ $\sqrt{\text{Hz}}$ |
| THS4150/1 | \pm 15 V, 150 MHz, 650 V/ μ s, 7.6 nV/ $\sqrt{\text{Hz}}$ |

(1) Even-numbered devices feature power-down capability.

APPLICATION CIRCUIT DIAGRAM

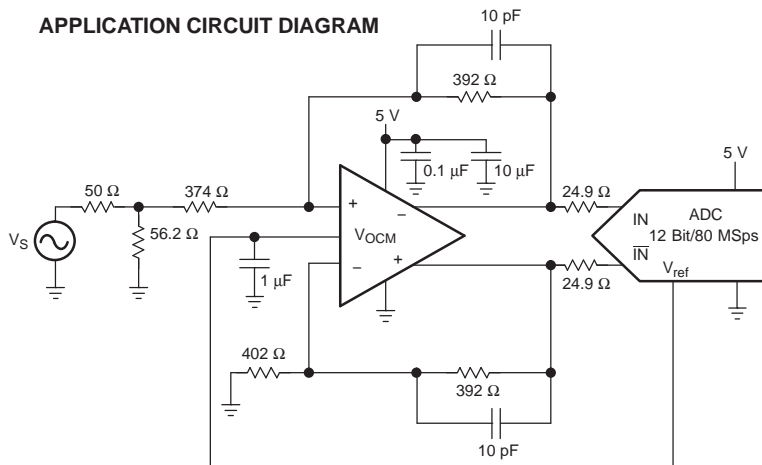

THIRD-ORDER INTERMODULATION DISTORTION

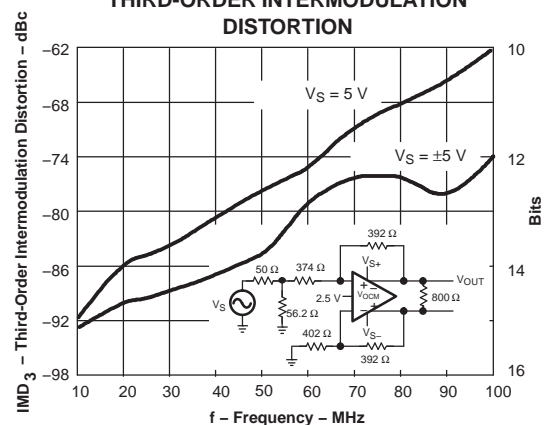

Please be aware that an important notice concerning availability, standard warranty, and use in critical applications of Texas Instruments semiconductor products and disclaimers thereto appears at the end of this data sheet.

PowerPAD is a trademark of Texas Instruments, Incorporated.
All other trademarks are the property of their respective owners.

PRODUCTION DATA information is current as of publication date. Products conform to specifications per the terms of the Texas Instruments standard warranty. Production processing does not necessarily include testing of all parameters.

Copyright © 2002–2011, Texas Instruments Incorporated



This integrated circuit can be damaged by ESD. Texas Instruments recommends that all integrated circuits be handled with appropriate precautions. Failure to observe proper handling and installation procedures can cause damage.

ESD damage can range from subtle performance degradation to complete device failure. Precision integrated circuits may be more susceptible to damage because very small parametric changes could cause the device not to meet its published specifications.

ABSOLUTE MAXIMUM RATINGS⁽¹⁾

Over operating free-air temperature range, unless otherwise noted.

| | | UNIT |
|--|----------|--|
| Supply voltage, V_S | | 16.5 V |
| Input voltage, V_I | | $\pm V_S$ |
| Output current, I_O ⁽²⁾ | | 150 mA |
| Differential input voltage, V_{ID} | | 4 V |
| Continuous power dissipation | | See Dissipation Rating Table |
| Maximum junction temperature, T_J ⁽³⁾ | | +150°C |
| Maximum junction temperature, continuous operation, long-term reliability, T_J | | +125°C |
| Operating free-air temperature range, T_A ⁽⁴⁾ | C suffix | 0°C to +70°C |
| | I suffix | –40°C to +85°C |
| Storage temperature range, T_{stg} | | –65°C to +150°C |
| Lead temperature 1,6 mm (1/16 inch) from case for 10 seconds | | +300°C |
| ESD rating: | HBM | 4000 V |
| | CDM | 1000 V |
| | MM | 100 V |

- (1) Stresses above these ratings may cause permanent damage. Exposure to absolute maximum conditions for extended periods may degrade device reliability. These are stress ratings only, and functional operation of the device at these or any other conditions beyond those specified is not implied.
- (2) The THS4500/1 may incorporate a PowerPAD on the underside of the chip. This acts as a heat sink and must be connected to a thermally dissipative plane for proper power dissipation. Failure to do so may result in exceeding the maximum junction temperature which could permanently damage the device. See TI technical briefs [SLMA002](#) and [SLMA004](#) for more information about utilizing the PowerPAD thermally-enhanced package.
- (3) The absolute maximum temperature under any condition is limited by the constraints of the silicon process.
- (4) The maximum junction temperature for continuous operation is limited by package constraints. Operation above this temperature may result in reduced reliability and/or lifetime of the device.

DISSIPATION RATINGS TABLE

| PACKAGE | θ_{JC} (°C/W) | θ_{JA} ⁽¹⁾ (°C/W) | POWER RATING ⁽²⁾ | |
|-------------|-------------------------|--|------------------------------|---------------------------|
| | | | $T_A \leq +25^\circ\text{C}$ | $T_A = +85^\circ\text{C}$ |
| D (8-pin) | 38.3 | 97.5 | 1.02 W | 410 mW |
| DGN (8-pin) | 4.7 | 58.4 | 1.71 W | 685 mW |
| DGK (8-pin) | 54.2 | 260 | 385 mW | 154 mW |

- (1) This data was taken using the JEDEC standard High-K test PCB.
- (2) Power rating is determined with a junction temperature of +125°C. This is the point where distortion starts to substantially increase. Thermal management of the final PCB should strive to keep the junction temperature at or below +125°C for best performance and long-term reliability.

RECOMMENDED OPERATING CONDITIONS

| | | MIN | NOM | MAX | UNIT |
|--|---------------|-----|---------|-----------|------|
| Supply voltage | Dual supply | | ± 5 | ± 7.5 | V |
| | Single supply | 4.5 | 5 | 15 | |
| Operating free- air temperature, T_A | C suffix | 0 | | +70 | °C |
| | I suffix | –40 | | +85 | |

PACKAGE/ORDERING INFORMATION⁽¹⁾

| TEMPERATURE | ORDERABLE PACKAGE AND NUMBER | | | | |
|----------------|------------------------------|--------------------------------------|--------|-----------------------------|--------|
| | PLASTIC SMALL OUTLINE (D) | PLASTIC MSOP ⁽²⁾ PowerPAD | | PLASTIC MSOP ⁽²⁾ | |
| | | DGN | SYMBOL | DGK | SYMBOL |
| 0°C to +70°C | THS4500CD | THS4500CDGN | BFB | THS4500CDGK | ATVB |
| | THS4501CD | THS4501CDGN | BFD | THS4501CDGK | ATW |
| –40°C to +85°C | THS4500ID | THS4500IDGN | BFC | THS4500IDGK | ASV |
| | THS4501ID | THS4501IDGN | BFE | THS4501IDGK | ASW |

- (1) For the most current package and ordering information see the Package Option Addendum at the end of this document, or see the TI web site at www.ti.com.
- (2) All packages are available taped and reeled. The R suffix standard quantity is 2500. The T suffix standard quantity is 250 (for example, THS4501DT).

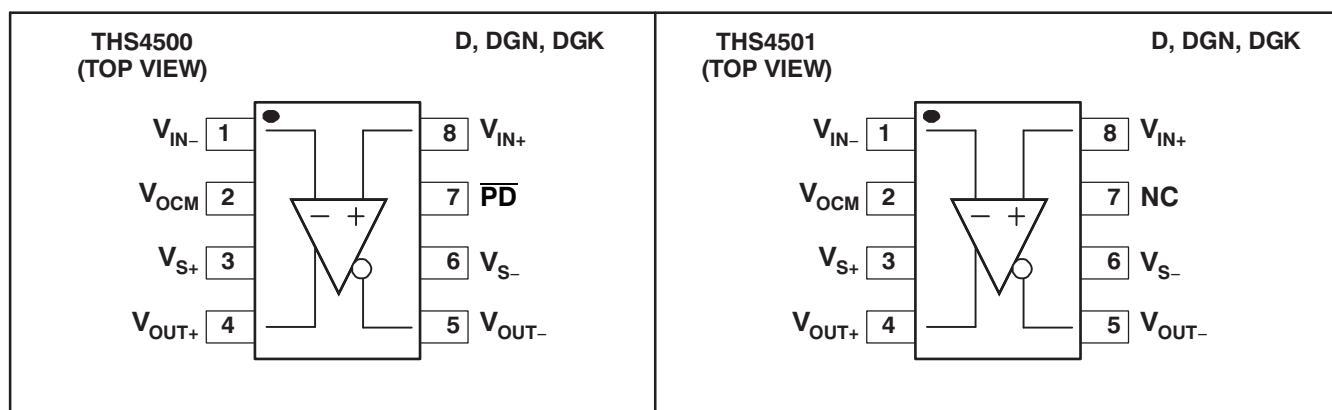
PIN ASSIGNMENTS

ELECTRICAL CHARACTERISTICS: $V_S = \pm 5\text{ V}$

$R_F = R_G = 392\ \Omega$, $R_L = 800\ \Omega$, $G = +1$, and single-ended input, unless otherwise noted.

| PARAMETER | TEST CONDITIONS | THS4500 AND THS4501 | | | | | MIN/ TYP/ MAX |
|---|---|---------------------|------------------|-----------------|-------------------|------------------------------|---------------------|
| | | TYP | OVER TEMPERATURE | | | | |
| | | +25°C | +25°C | 0°C to +70°C | -40°C to +85°C | UNITS | |
| AC PERFORMANCE | | | | | | | |
| Small-signal bandwidth | $G = +1$, $P_{IN} = -20\text{ dBm}$, $R_F = 392\ \Omega$ | 370 | | | | MHz | Typ |
| | $G = +2$, $P_{IN} = -30\text{ dBm}$, $R_F = 1\text{ k}\Omega$ | 175 | | | | MHz | Typ |
| | $G = +5$, $P_{IN} = -30\text{ dBm}$, $R_F = 2.4\text{ k}\Omega$ | 70 | | | | MHz | Typ |
| | $G = +10$, $P_{IN} = -30\text{ dBm}$, $R_F = 5.1\text{ k}\Omega$ | 30 | | | | MHz | Typ |
| Gain-bandwidth product | $G > +10$ | 300 | | | | MHz | Typ |
| Bandwidth for 0.1-dB flatness | $P_{IN} = -20\text{ dBm}$ | 150 | | | | MHz | Typ |
| Large-signal bandwidth | $V_P = 2\text{ V}$ | 220 | | | | MHz | Typ |
| Slew rate | 4 V_{PP} Step | 2800 | | | | V/ μ s | Typ |
| Rise time | 2 V_{PP} Step | 0.4 | | | | ns | Typ |
| Fall time | 2 V_{PP} Step | 0.5 | | | | ns | Typ |
| Settling time to 0.01% | $V_O = 4\ V_{PP}$ | 8.3 | | | | ns | Typ |
| 0.1% | $V_O = 4\ V_{PP}$ | 6.3 | | | | ns | Typ |
| Harmonic distortion | $G = +1$, $V_O = 2\ V_{PP}$ | | | | | | Typ |
| 2nd harmonic | $f = 8\text{ MHz}$ | -82 | | | | dBc | Typ |
| | $f = 30\text{ MHz}$ | -71 | | | | dBc | Typ |
| 3rd harmonic | $f = 8\text{ MHz}$ | -97 | | | | dBc | Typ |
| | $f = 30\text{ MHz}$ | -74 | | | | dBc | Typ |
| Third-order intermodulation distortion | $V_O = 2\ V_{PP}$, $f_C = 30\text{ MHz}$, $R_F = 392\ \Omega$, 200 kHz tone spacing | -90 | | | | dBc | Typ |
| Third-order output intercept point | $f_C = 30\text{ MHz}$, $R_F = 392\ \Omega$, Referenced to 50 Ω | 49 | | | | dBm | Typ |
| Input voltage noise | $f > 1\text{ MHz}$ | 7 | | | | nV/ $\sqrt{\text{Hz}}$ | Typ |
| Input current noise | $f > 100\text{ kHz}$ | 1.7 | | | | pA/ $\sqrt{\text{Hz}}$ | Typ |
| Overdrive recovery time | Overdrive = 5.5 V | 60 | | | | ns | Typ |
| DC PERFORMANCE | | | | | | | |
| Open-loop voltage gain | | 55 | 52 | 50 | 50 | dB | Min |
| Input offset voltage | | -4 | -7/-1 | -8/0 | -9/+1 | mV | Max |
| Average offset voltage drift | | | | ± 10 | ± 10 | $\mu\text{V}/^\circ\text{C}$ | Typ |
| Input bias current | | 4 | 4.6 | 5 | 5.2 | μA | Max |
| Average bias current drift | | | | ± 10 | ± 10 | nA/ $^\circ\text{C}$ | Typ |
| Input offset current | | 0.5 | 1 | 2 | 2 | μA | Max |
| Average offset current drift | | | | ± 40 | ± 40 | nA/ $^\circ\text{C}$ | Typ |
| INPUT | | | | | | | |
| Common-mode input range | | -5.7/2.6 | -5.4/2.3 | -5.1/2 | -5.1/2 | V | Min |
| Common-mode rejection ratio | | 80 | 74 | 70 | 70 | dB | Min |
| Input impedance | | $10^7 \parallel 1$ | | | | $\Omega \parallel \text{pF}$ | Typ |
| OUTPUT | | | | | | | |
| Differential output voltage swing | $R_L = 1\text{ k}\Omega$ | ± 8 | ± 7.6 | ± 7.4 | ± 7.4 | V | Min |
| Differential output current drive | $R_L = 20\ \Omega$ | 120 | 110 | 100 | 100 | mA | Min |
| Output balance error | $P_{IN} = -20\text{ dBm}$, $f = 100\text{ kHz}$ | -58 | | | | dB | Typ |
| Closed-loop output impedance (single-ended) | $f = 1\text{ MHz}$ | 0.1 | | | | Ω | Typ |

ELECTRICAL CHARACTERISTICS: $V_S = \pm 5\text{ V}$ (continued)
 $R_F = R_G = 392\ \Omega$, $R_L = 800\ \Omega$, $G = +1$, and single-ended input, unless otherwise noted.

| PARAMETER | TEST CONDITIONS | THS4500 AND THS4501 | | | | | |
|---|---|---------------------|------------------|-----------------|-------------------|------------------|---------------------|
| | | TYP | OVER TEMPERATURE | | | | MIN/ TYP/ MAX |
| | | +25°C | +25°C | 0°C to +70°C | -40°C to +85°C | UNITS | |
| OUTPUT COMMON-MODE VOLTAGE CONTROL | | | | | | | |
| Small-signal bandwidth | $R_L = 400\ \Omega$ | 180 | | | | MHz | Typ |
| Slew rate | 2 V_{PP} Step | 92 | | | | V/ μ s | Typ |
| Minimum gain | | 1 | 0.98 | 0.98 | 0.98 | V/V | Min |
| Maximum gain | | 1 | 1.02 | 1.02 | 1.02 | V/V | Max |
| Common-mode offset voltage | | -0.4 | -4.6/+3.8 | -6.6/+5.8 | -7.6/+6.8 | mV | Max |
| Input bias current | $V_{OCM} = 2.5\text{ V}$ | 100 | 150 | 170 | 170 | μ A | Max |
| Input voltage range | | ± 4 | ± 3.7 | ± 3.4 | ± 3.4 | V | Min |
| Input impedance | | 25 1 | | | | k Ω pF | Typ |
| Maximum default voltage | V_{OCM} left floating | 0 | 0.05 | 0.10 | 0.10 | V | Max |
| Minimum default voltage | V_{OCM} left floating | 0 | -0.05 | -0.10 | -0.10 | V | Min |
| POWER SUPPLY | | | | | | | |
| Specified operating voltage | | ± 5 | 7.5 | 7.5 | 7.5 | V | Max |
| Maximum quiescent current | | 23 | 28 | 32 | 34 | mA | Max |
| Minimum quiescent current | | 23 | 18 | 14 | 12 | mA | Min |
| Power-supply rejection (\pm PSRR) | | 80 | 76 | 73 | 70 | dB | Min |
| POWER-DOWN (THS4500 ONLY) | | | | | | | |
| Enable voltage threshold | Device enabled <i>ON</i> above -2.9 V | | -2.9 | | | V | Min |
| Disable voltage threshold | Device disabled <i>OFF</i> below -4.3 V | | -4.3 | | | V | Max |
| Power-down quiescent current | | 800 | 1000 | 1200 | 1200 | μ A | Max |
| Input bias current | | 200 | 240 | 260 | 260 | μ A | Max |
| Input impedance | | 50 1 | | | | k Ω pF | Typ |
| Turn-on time delay | | 1000 | | | | ns | Typ |
| Turn-off time delay | | 800 | | | | ns | Typ |

ELECTRICAL CHARACTERISTICS: $V_S = 5\text{ V}$

$R_F = R_G = 392\ \Omega$, $R_L = 800\ \Omega$, $G = +1$, and single-ended input, unless otherwise noted.

| PARAMETER | TEST CONDITIONS | THS4500 AND THS4501 | | | | | |
|---|--|---------------------|------------------|--------------|----------------|------------------------------|-------------|
| | | TYP | OVER TEMPERATURE | | | | MIN/TYP/MAX |
| | | +25°C | +25°C | 0°C to +70°C | -40°C to +85°C | UNITS | |
| AC PERFORMANCE | | | | | | | |
| Small-signal bandwidth | $G = +1$, $P_{IN} = -20\text{ dBm}$, $R_F = 392\ \Omega$ | 320 | | | | MHz | Typ |
| | $G = +2$, $P_{IN} = -30\text{ dBm}$, $R_F = 1\text{ k}\Omega$ | 160 | | | | MHz | Typ |
| | $G = +5$, $P_{IN} = -30\text{ dBm}$, $R_F = 2.4\text{ k}\Omega$ | 60 | | | | MHz | Typ |
| | $G = +10$, $P_{IN} = -30\text{ dBm}$, $R_F = 5.1\text{ k}\Omega$ | 30 | | | | MHz | Typ |
| Gain-bandwidth product | $G > +10$ | 300 | | | | MHz | Typ |
| Bandwidth for 0.1-dB flatness | $P_{IN} = -20\text{ dBm}$ | 180 | | | | MHz | Typ |
| Large-signal bandwidth | $V_P = 1\text{ V}$ | 200 | | | | MHz | Typ |
| Slew rate | 2 V_{PP} Step | 1300 | | | | V/ μs | Typ |
| Rise time | 2 V_{PP} Step | 0.5 | | | | ns | Typ |
| Fall time | 2 V_{PP} Step | 0.6 | | | | ns | Typ |
| Settling time to 0.01% | $V_O = 2\text{ V}$ Step | 13.1 | | | | ns | Typ |
| 0.1% | $V_O = 2\text{ V}$ Step | 8.3 | | | | ns | Typ |
| Harmonic distortion | $G = +1$, $V_O = 2\text{ V}_{PP}$ | | | | | | Typ |
| 2nd harmonic | $f = 8\text{ MHz}$, | -80 | | | | dBc | Typ |
| | $f = 30\text{ MHz}$ | -55 | | | | dBc | Typ |
| 3rd harmonic | $f = 8\text{ MHz}$ | -76 | | | | dBc | Typ |
| | $f = 30\text{ MHz}$ | -60 | | | | dBc | Typ |
| Input voltage noise | $f > 1\text{ MHz}$ | 7 | | | | nV/ $\sqrt{\text{Hz}}$ | Typ |
| Input current noise | $f > 100\text{ kHz}$ | 1.7 | | | | pA/ $\sqrt{\text{Hz}}$ | Typ |
| Overdrive recovery time | Overdrive = 5.5 V | 60 | | | | ns | Typ |
| DC PERFORMANCE | | | | | | | |
| Open-loop voltage gain | | 54 | 51 | 49 | 49 | dB | Min |
| Input offset voltage | | -4 | -7/-1 | -8/0 | -9/+1 | mV | Max |
| Average offset voltage drift | | | | ± 10 | ± 10 | $\mu\text{V}/^\circ\text{C}$ | Typ |
| Input bias current | | 4 | 4.6 | 5 | 5.2 | μA | Max |
| Average bias current drift | | | | ± 10 | ± 10 | nA/ $^\circ\text{C}$ | Typ |
| Input offset current | | 0.5 | 0.7 | 1.2 | 1.2 | μA | Max |
| Average offset current drift | | | | ± 20 | ± 20 | nA/ $^\circ\text{C}$ | Typ |
| INPUT | | | | | | | |
| Common-mode input range | | -0.7/2.6 | -0.4/2.3 | -0.1/2 | -0.1/2 | V | Min |
| Common-mode rejection ratio | | 80 | 74 | 70 | 70 | dB | Min |
| Input Impedance | | $10^7 \parallel 1$ | | | | $\Omega \parallel \text{pF}$ | Typ |
| OUTPUT | | | | | | | |
| Differential output voltage swing | $R_L = 1\text{ k}\Omega$, Referenced to 2.5 V | ± 3.3 | ± 3 | ± 2.8 | ± 2.8 | V | Min |
| Output current drive | $R_L = 20\ \Omega$ | 100 | 90 | 80 | 80 | mA | Min |
| Output balance error | $P_{IN} = -20\text{ dBm}$, $f = 100\text{ kHz}$ | -58 | | | | dB | Typ |
| Closed-loop output impedance (single-ended) | $f = 1\text{ MHz}$ | 0.1 | | | | Ω | Typ |

ELECTRICAL CHARACTERISTICS: $V_S = 5\text{ V}$ (continued)
 $R_F = R_G = 392\ \Omega$, $R_L = 800\ \Omega$, $G = +1$, and single-ended input, unless otherwise noted.

| PARAMETER | TEST CONDITIONS | THS4500 AND THS4501 | | | | | |
|---|--|---------------------|------------------|-----------------|-------------------|------------------|--------------------|
| | | TYP | OVER TEMPERATURE | | | | MIN/ YP/M AX |
| | | +25°C | +25°C | 0°C to +70°C | -40°C to +85°C | UNITS | |
| OUTPUT COMMON-MODE VOLTAGE CONTROL | | | | | | | |
| Small-signal bandwidth | $R_L = 400\ \Omega$ | 180 | | | | MHz | Typ |
| Slew rate | $2\ V_{PP}\ \text{Step}$ | 80 | | | | V/ μs | Typ |
| Minimum gain | | 1 | 0.98 | 0.98 | 0.98 | V/V | Min |
| Maximum gain | | 1 | 1.02 | 1.02 | 1.02 | V/V | Max |
| Common-mode offset voltage | | 0.4 | -2.6/3.4 | -4.2/5.4 | -5.6/6.4 | mV | Max |
| Input bias current | $V_{OCM} = 2.5\ \text{V}$ | 1 | 2 | 3 | 3 | μA | Max |
| Input voltage range | | 1/4 | 1.2/3.8 | 1.3/3.7 | 1.3/3.7 | V | Min |
| Input impedance | | 25 1 | | | | k Ω pF | Typ |
| Maximum default voltage | V_{OCM} left floating | 2.5 | 2.55 | 2.6 | 2.6 | V | Max |
| Minimum default voltage | V_{OCM} left floating | 2.5 | 2.45 | 2.4 | 2.4 | V | Min |
| POWER SUPPLY | | | | | | | |
| Specified operating voltage | | 5 | 15 | 15 | 15 | V | Max |
| Maximum quiescent current | | 20 | 25 | 29 | 31 | mA | Max |
| Minimum quiescent current | | 20 | 16 | 12 | 10 | mA | Min |
| Power-supply rejection (+PSRR) | | 75 | 72 | 69 | 66 | dB | Min |
| POWER -DOWN (THS4500 ONLY) | | | | | | | |
| Enable voltage threshold | Device enabled <i>ON</i> above 2.1 V | | 2.1 | | | V | Min |
| Disable voltage threshold | Device disabled <i>OFF</i> below 0.7 V | | 0.7 | | | V | Max |
| Power-down quiescent current | | 600 | 800 | 1200 | 1200 | μA | Max |
| Input bias current | | 100 | 125 | 140 | 140 | μA | Max |
| Input impedance | | 50 1 | | | | k Ω pF | Typ |
| Turn-on time delay | | 1000 | | | | ns | Typ |
| Turn-off time delay | | 800 | | | | ns | Typ |

TYPICAL CHARACTERISTICS

Table of Graphs (± 5 V)

| | | FIGURE |
|--|-------------------------------------|----------------|
| Small-signal unity-gain frequency response | | 1 |
| Small-signal frequency response | | 2 |
| 0.1-dB gain flatness frequency response | | 3 |
| Large-signal frequency response | | 4 |
| Harmonic distortion (single-ended input to differential output) | vs Frequency | 5, 7, 13, 15 |
| Harmonic distortion (differential input to differential output) | vs Frequency | 6, 8, 14, 16 |
| Harmonic distortion (single-ended input to differential output) | vs Output voltage swing | 9, 11, 17, 19 |
| Harmonic distortion (differential input to differential output) | vs Output voltage swing | 10, 12, 18, 20 |
| Harmonic distortion (single-ended input to differential output) | vs Load resistance | 21 |
| Harmonic distortion (differential input to differential output) | vs Load resistance | 22 |
| Third-order intermodulation distortion (single-ended input to differential output) | vs Frequency | 23 |
| Third-order output intercept point | vs Frequency | 24 |
| Slew rate | vs Differential output voltage step | 25 |
| Settling time | | 26, 27 |
| Large-signal transient response | | 28 |
| Small-signal transient response | | 29 |
| Overdrive recovery | | 30, 31 |
| Voltage and current noise | vs Frequency | 32 |
| Rejection ratios | vs Frequency | 33 |
| Rejection ratios | vs Case temperature | 34 |
| Output balance error | vs Frequency | 35 |
| Open-loop gain and phase | vs Frequency | 36 |
| Open-loop gain | vs Case temperature | 37 |
| Input bias offset current | vs Case temperature | 38 |
| Quiescent current | vs Supply voltage | 39 |
| Input offset voltage | vs Case temperature | 40 |
| Common-mode rejection ratio | vs Input common-mode range | 41 |
| Output drive | vs Case temperature | 42 |
| Harmonic distortion (single-ended and differential input to differential output) | vs Output common-mode voltage | 43 |
| Small-signal frequency response at V_{OCM} | | 44 |
| Output offset voltage at V_{OCM} | vs Output common-mode voltage | 45 |
| Quiescent current | vs Power-down voltage | 46 |
| Turn-on and turn-off delay times | | 47 |
| Single-ended output impedance in power-down | vs Frequency | 48 |
| Power-down quiescent current | vs Case temperature | 49 |
| | vs Supply voltage | 50 |

Table of Graphs (5 V)

| | | FIGURE |
|---|-------------------------------------|----------------|
| Small-signal unity-gain frequency response | | 51 |
| Small-signal frequency response | | 52 |
| 0.1-dB gain flatness frequency response | | 53 |
| Large-signal frequency response | | 54 |
| Harmonic distortion (single-ended input to differential output) | vs Frequency | 55, 57, 63, 65 |
| Harmonic distortion (differential input to differential output) | vs Frequency | 56, 58, 64, 66 |
| Harmonic distortion (single-ended input to differential output) | vs Output voltage swing | 59, 61, 67, 69 |
| Harmonic distortion (differential input to differential output) | vs Output voltage swing | 60, 62, 68, 70 |
| Harmonic distortion (single-ended input to differential output) | vs Load resistance | 71 |
| Harmonic distortion (differential input to differential output) | vs Load resistance | 72 |
| Third-order intermodulation distortion | vs Frequency | 73 |
| Third-order intercept point | vs Frequency | 74 |
| Slew rate | vs Differential output voltage step | 75 |
| Large-signal transient response | | 76 |
| Small-signal transient response | | 77 |
| Voltage and current noise | vs Frequency | 78 |
| Rejection ratios | vs Frequency | 79 |
| Rejection ratios | vs Case temperature | 80 |
| Output balance error | vs Frequency | 81 |
| Open-loop gain and phase | vs Frequency | 82 |
| Open-loop gain | vs Case temperature | 83 |
| Input bias offset current | vs Case temperature | 84 |
| Quiescent current | vs Supply voltage | 85 |
| Input offset voltage | vs Case temperature | 86 |
| Common-mode rejection ratio | vs Input common-mode range | 87 |
| Output drive | vs Case temperature | 88 |
| Harmonic distortion (single-ended and differential input) | vs Output common-mode voltage | 89 |
| Small-signal frequency response at V_{OCM} | | 90 |
| Output offset voltage | vs Output common-mode voltage | 91 |
| Quiescent current | vs Power-down voltage | 92 |
| Turn-on and turn-off delay times | | 93 |
| Single-ended output impedance in power-down | vs Frequency | 94 |
| Power-down quiescent current | vs Case temperature | 95 |
| | vs Supply voltage | 96 |

TYPICAL CHARACTERISTICS: ±5 V

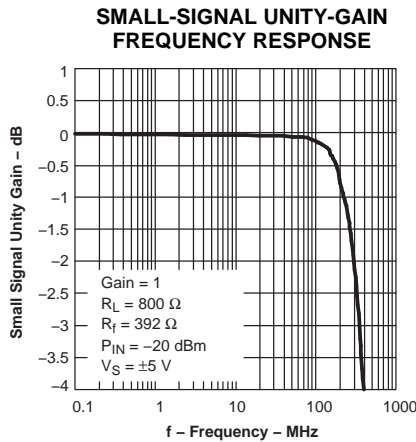

Figure 1.

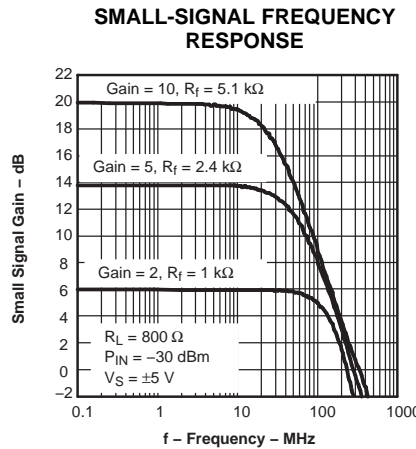

Figure 2.

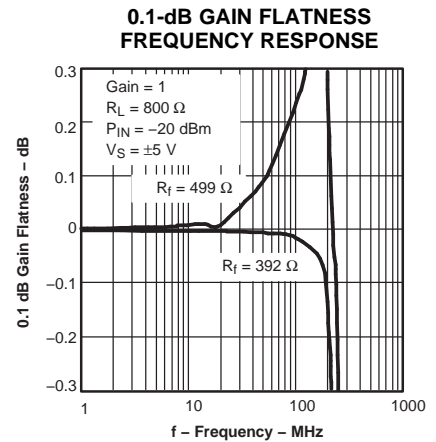

Figure 3.

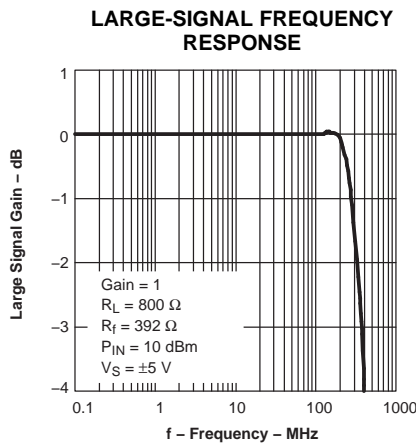

Figure 4.

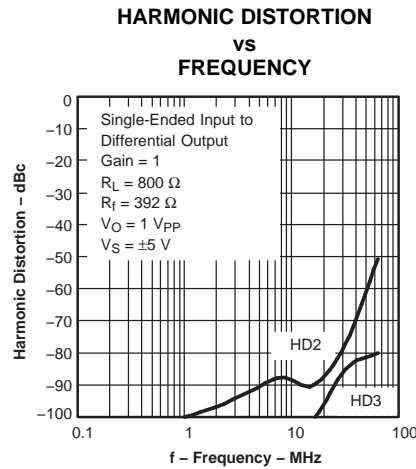

Figure 5.

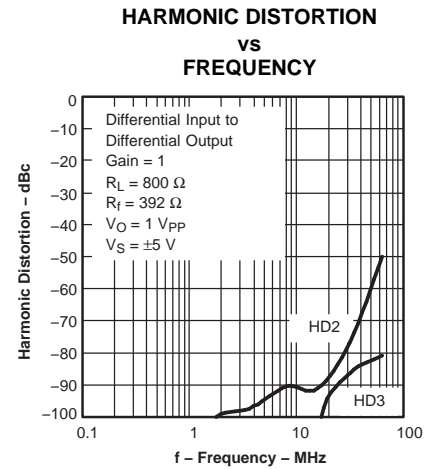

Figure 6.

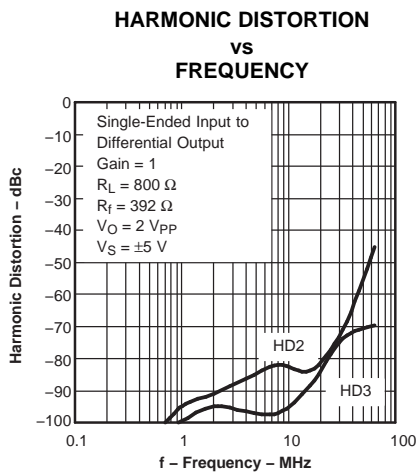

Figure 7.

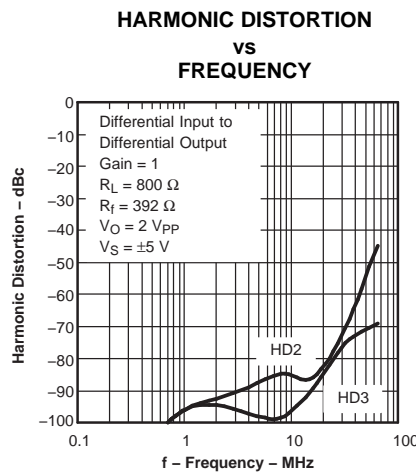

Figure 8.

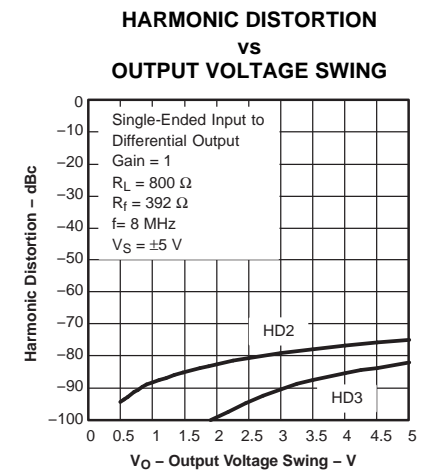

Figure 9.

TYPICAL CHARACTERISTICS: ±5 V (continued)

HARMONIC DISTORTION
vs
OUTPUT VOLTAGE SWING

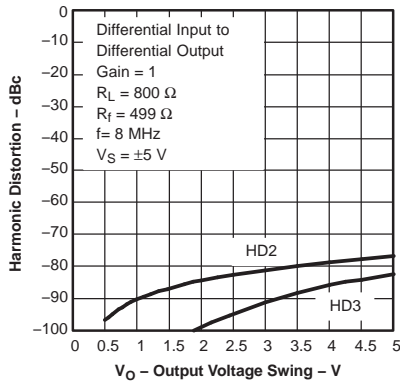

Figure 10.

HARMONIC DISTORTION
vs
OUTPUT VOLTAGE SWING

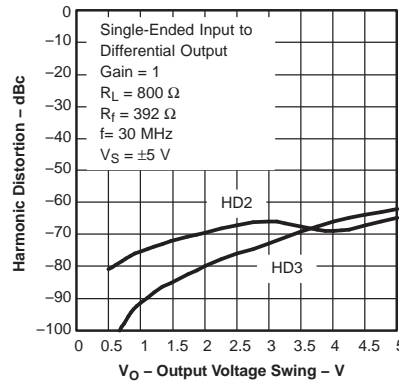

Figure 11.

HARMONIC DISTORTION
vs
OUTPUT VOLTAGE SWING

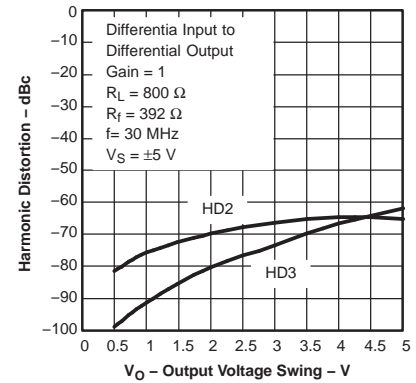

Figure 12.

HARMONIC DISTORTION
vs
FREQUENCY

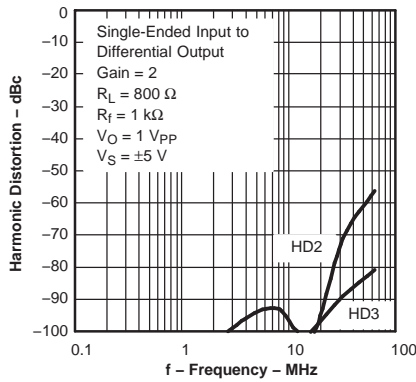

Figure 13.

HARMONIC DISTORTION
vs
FREQUENCY

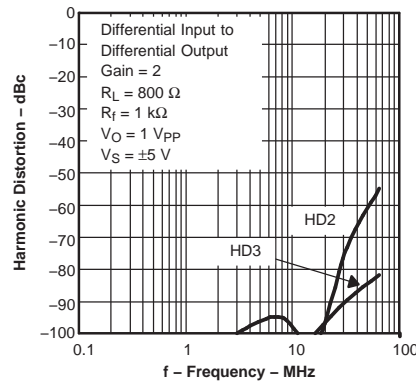

Figure 14.

HARMONIC DISTORTION
vs
FREQUENCY

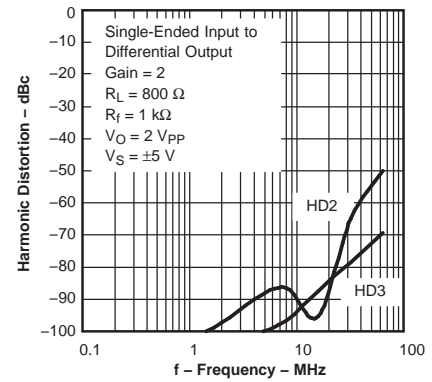

Figure 15.

HARMONIC DISTORTION
vs
FREQUENCY

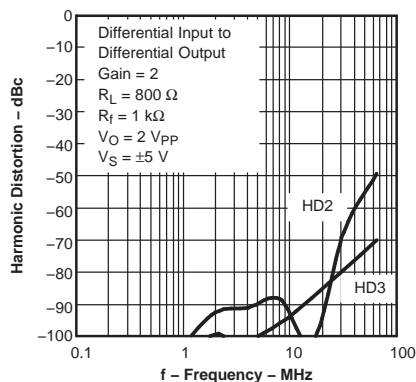

Figure 16.

HARMONIC DISTORTION
vs
OUTPUT VOLTAGE SWING

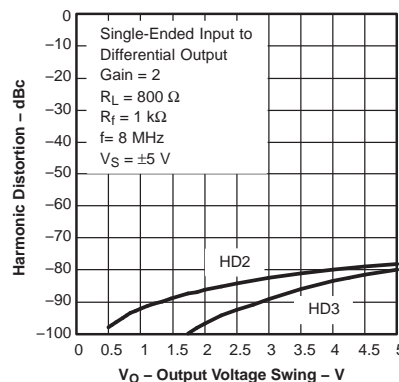

Figure 17.

HARMONIC DISTORTION
vs
OUTPUT VOLTAGE SWING

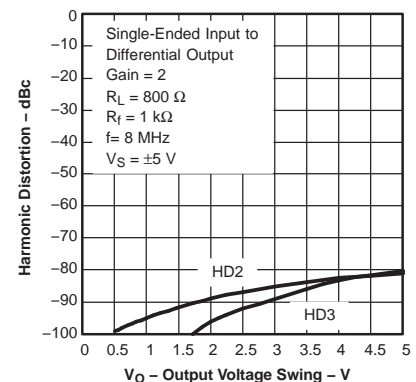

Figure 18.

TYPICAL CHARACTERISTICS: ±5 V (continued)

HARMONIC DISTORTION
vs
OUTPUT VOLTAGE SWING

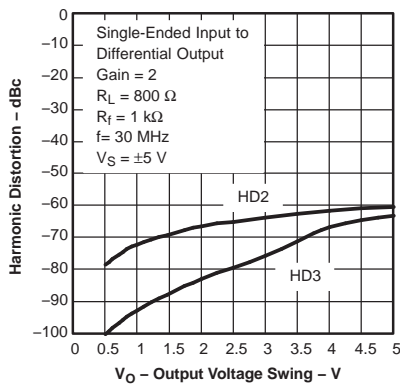

Figure 19.

HARMONIC DISTORTION
vs
OUTPUT VOLTAGE SWING

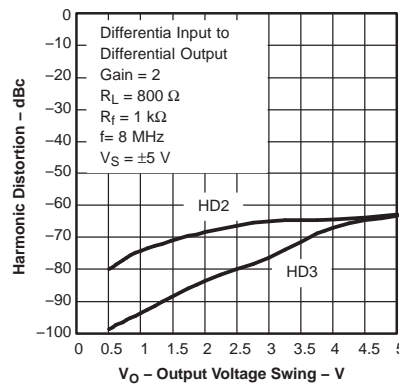

Figure 20.

HARMONIC DISTORTION
vs
LOAD RESISTANCE

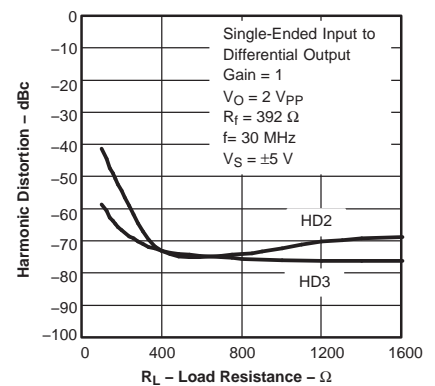

Figure 21.

HARMONIC DISTORTION
vs
LOAD RESISTANCE

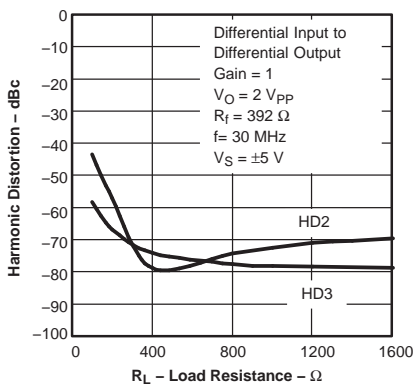

Figure 22.

THIRD-ORDER INTERMODULATION
DISTORTION
vs
FREQUENCY

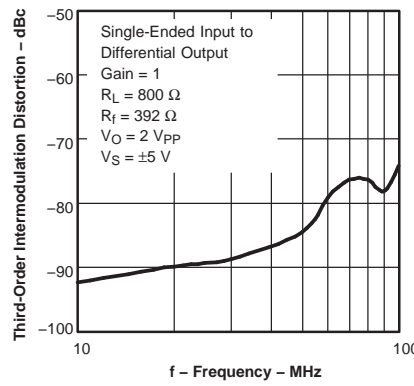

Figure 23.

THIRD-ORDER OUTPUT INTERCEPT
POINT
vs
FREQUENCY

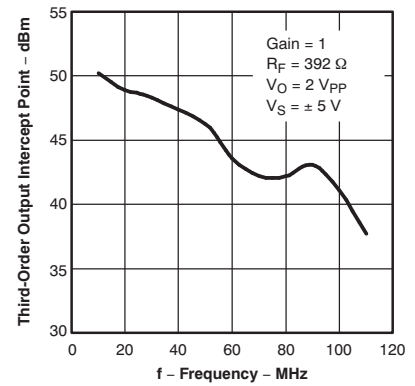

Figure 24.

SLEW RATE
vs
DIFFERENTIAL OUTPUT VOLTAGE
STEP

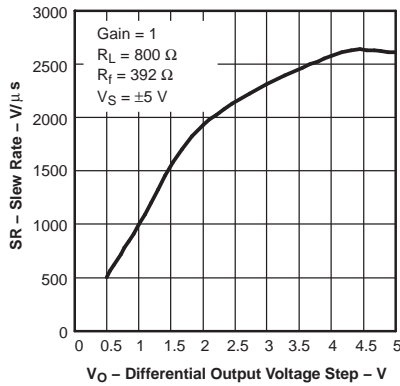

Figure 25.

SETTLING TIME

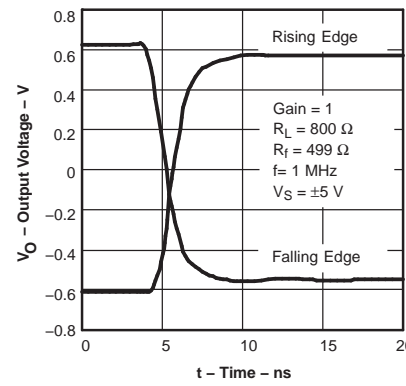

Figure 26.

SETTLING TIME

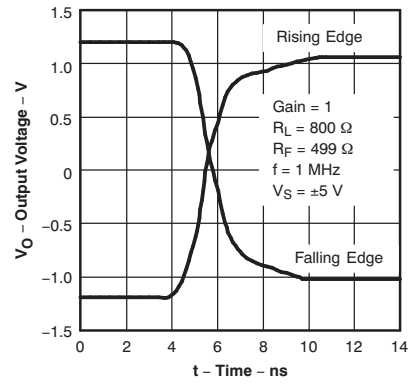

Figure 27.

TYPICAL CHARACTERISTICS: ± 5 V (continued)

LARGE-SIGNAL TRANSIENT RESPONSE

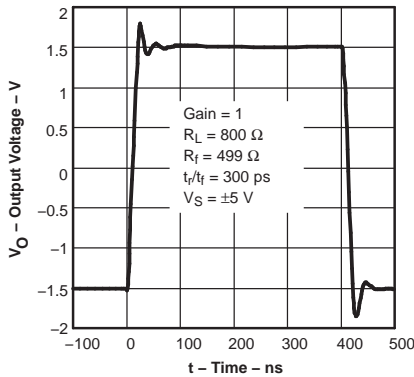

Figure 28.

SMALL-SIGNAL TRANSIENT RESPONSE

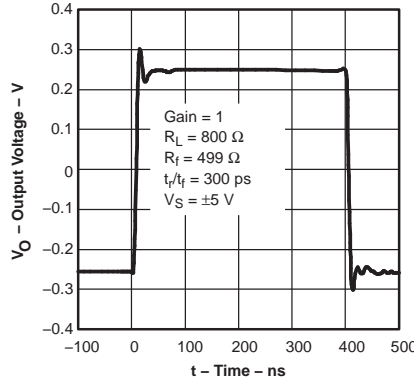

Figure 29.

OVERDRIVE RECOVERY

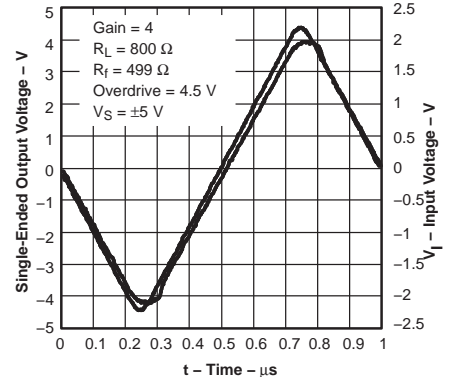

Figure 30.

OVERDRIVE RECOVERY

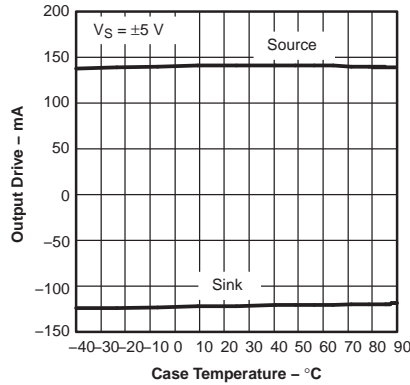

Figure 31.

VOLTAGE AND CURRENT NOISE vs FREQUENCY

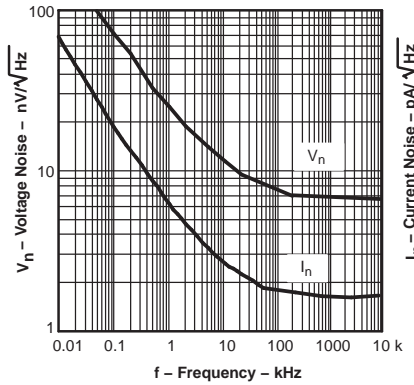

Figure 32.

REJECTION RATIOS vs FREQUENCY

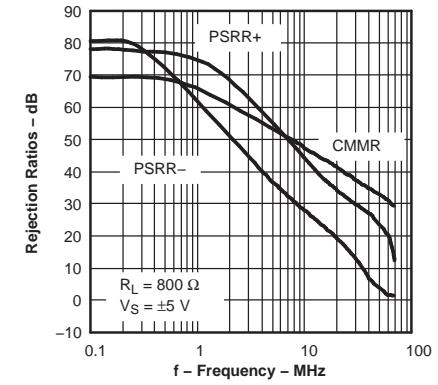

Figure 33.

REJECTION RATIOS vs CASE TEMPERATURE

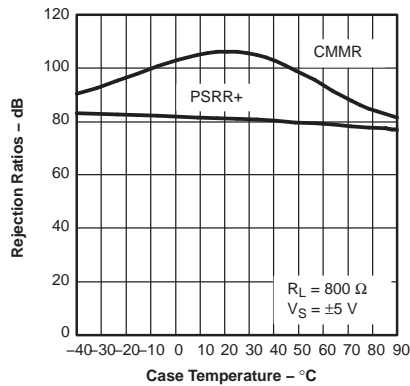

Figure 34.

OUTPUT BALANCE ERROR vs FREQUENCY

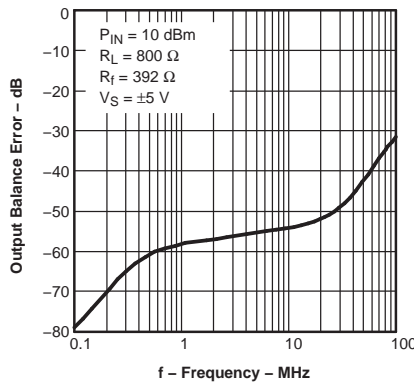

Figure 35.

OPEN-LOOP GAIN AND PHASE vs FREQUENCY

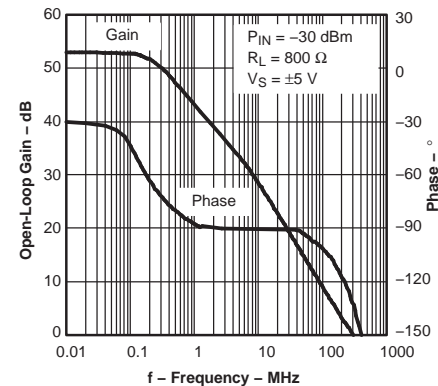

Figure 36.

TYPICAL CHARACTERISTICS: ±5 V (continued)

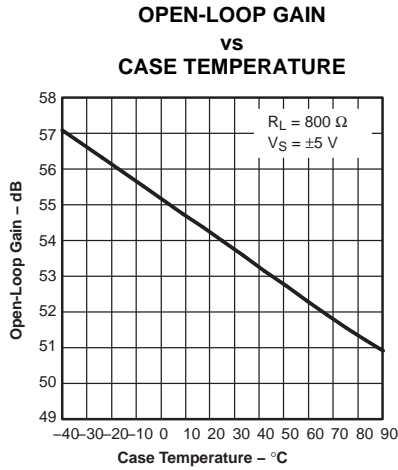

Figure 37.

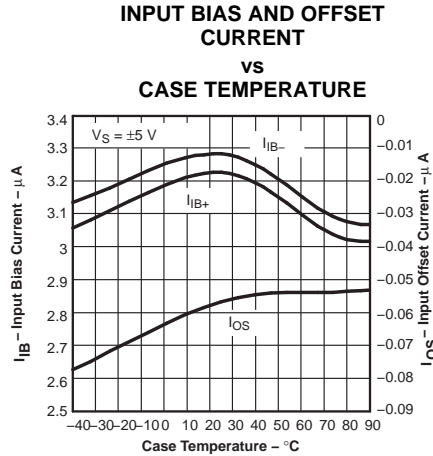

Figure 38.

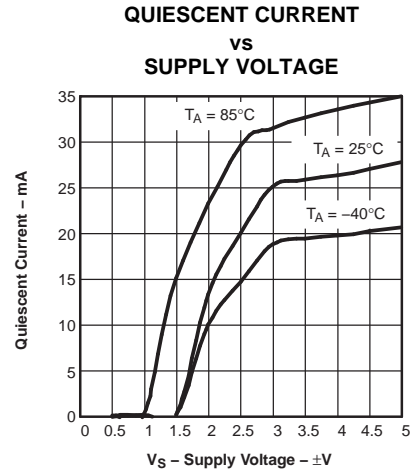

Figure 39.

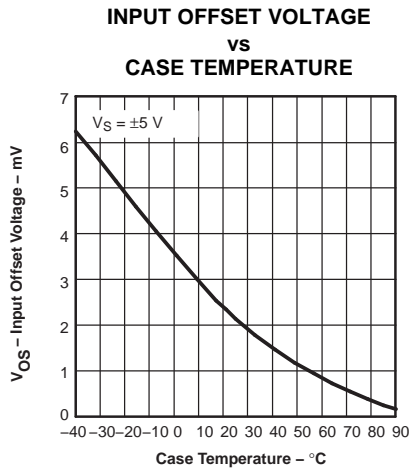

Figure 40.

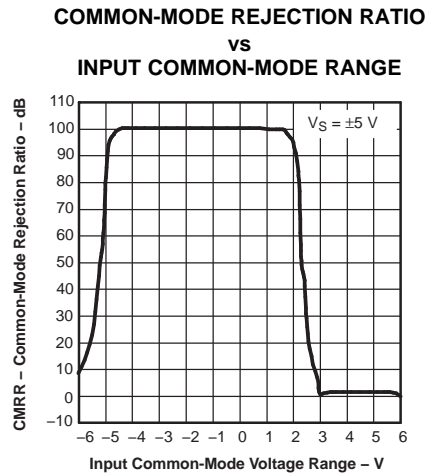

Figure 41.

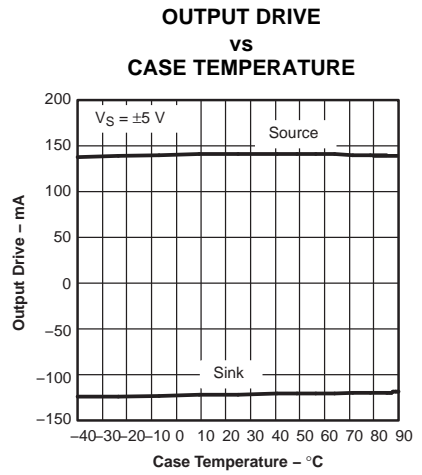

Figure 42.

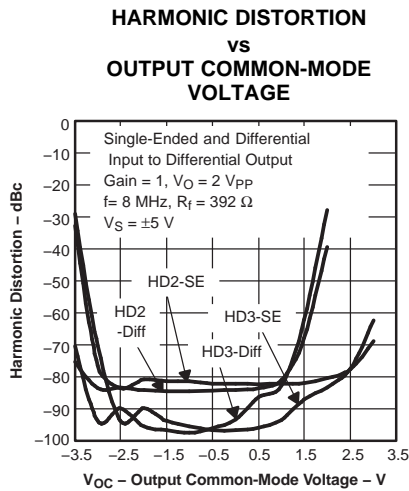

Figure 43.

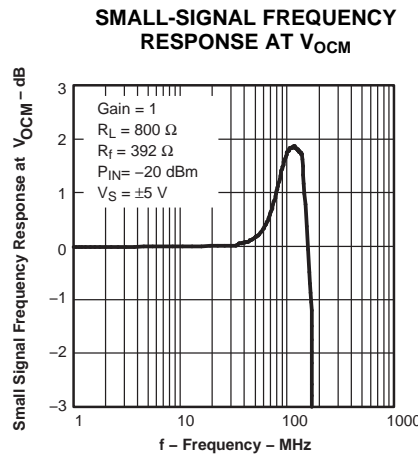

Figure 44.

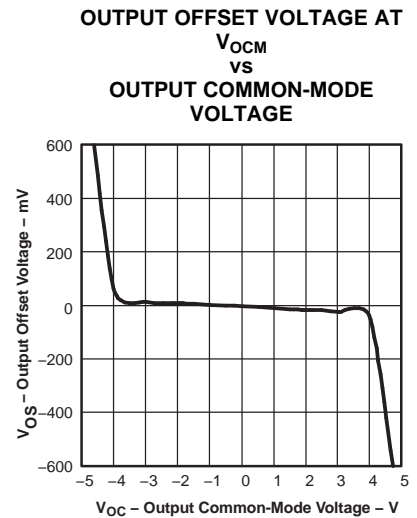

Figure 45.

TYPICAL CHARACTERISTICS: ± 5 V (continued)

QUIESCENT CURRENT
vs
POWER-DOWN VOLTAGE

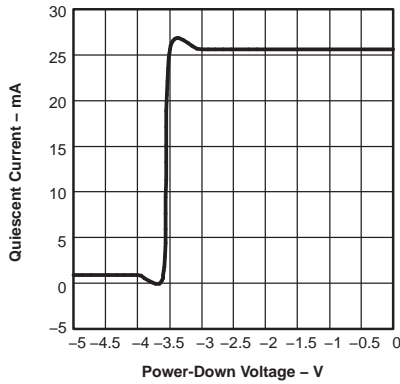

Figure 46.

TURN-ON AND TURN-OFF DELAY
TIME

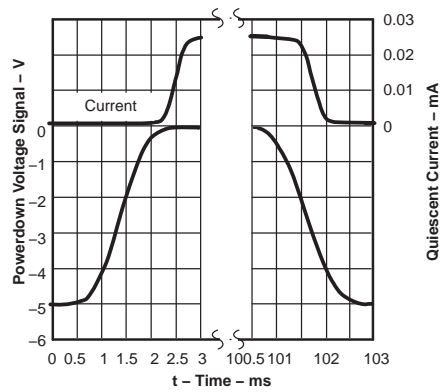

Figure 47.

SINGLE-ENDED OUTPUT
IMPEDANCE IN POWER-DOWN
vs
FREQUENCY

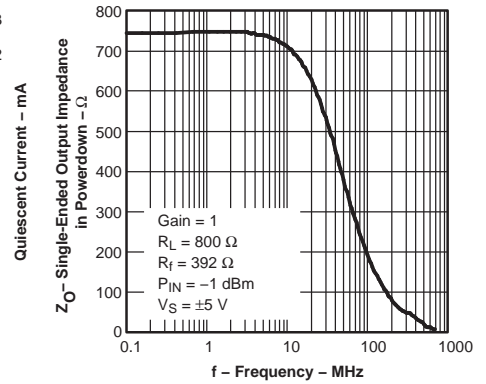

Figure 48.

POWER-DOWN QUIESCENT CURRENT
vs
CASE TEMPERATURE

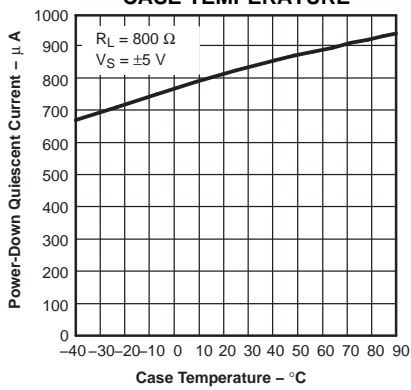

Figure 49.

POWER-DOWN QUIESCENT CURRENT
vs
SUPPLY VOLTAGE

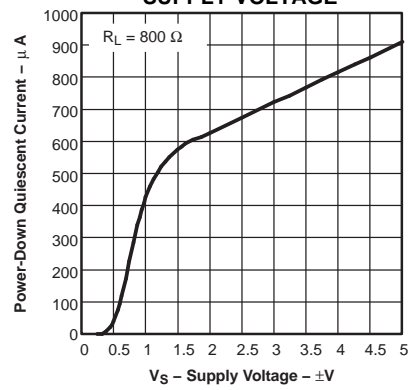

Figure 50.

TYPICAL CHARACTERISTICS: 5 V

SMALL-SIGNAL UNITY-GAIN
FREQUENCY RESPONSE

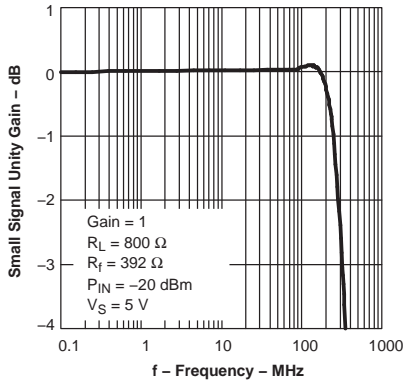

Figure 51.

SMALL-SIGNAL FREQUENCY
RESPONSE

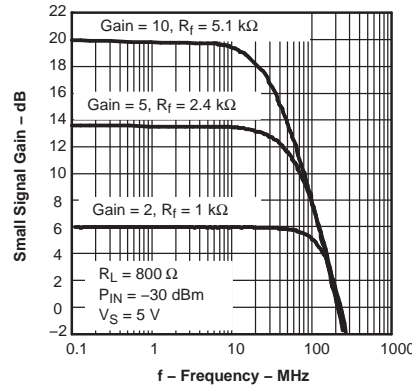

Figure 52.

0.1-dB GAIN FLATNESS
FREQUENCY RESPONSE

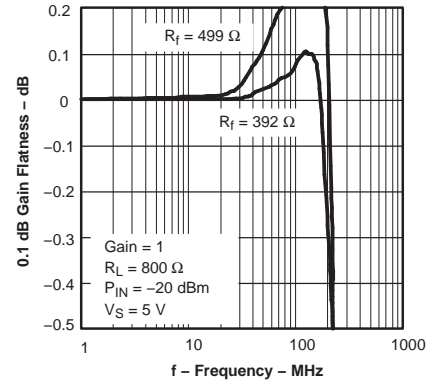

Figure 53.

LARGE-SIGNAL FREQUENCY
RESPONSE

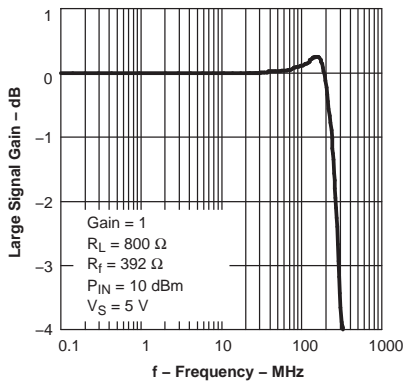

Figure 54.

HARMONIC DISTORTION
vs
FREQUENCY

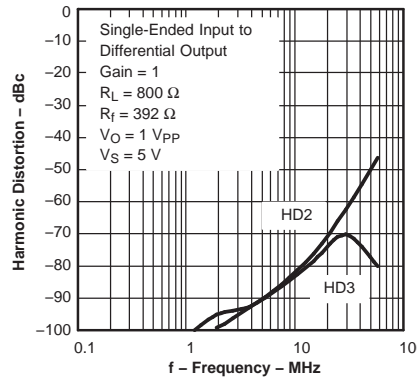

Figure 55.

HARMONIC DISTORTION
vs
FREQUENCY

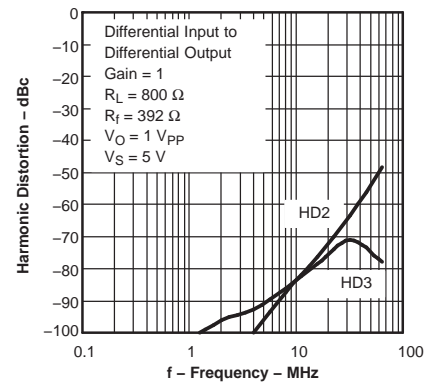

Figure 56.

HARMONIC DISTORTION
vs
FREQUENCY

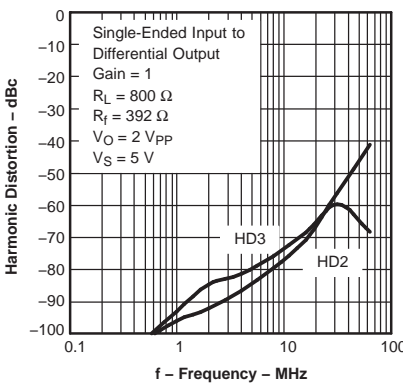

Figure 57.

HARMONIC DISTORTION
vs
FREQUENCY

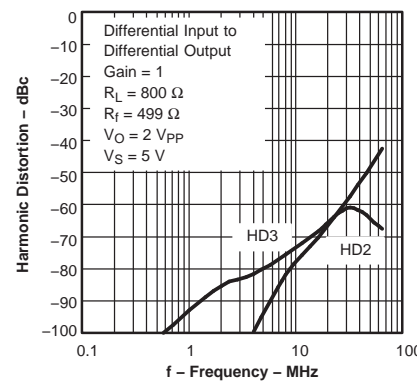

Figure 58.

HARMONIC DISTORTION
vs
OUTPUT VOLTAGE SWING

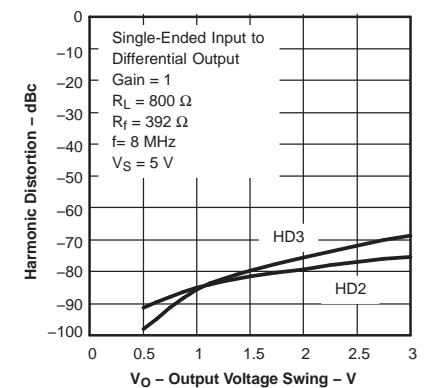

Figure 59.

TYPICAL CHARACTERISTICS: 5 V (continued)

HARMONIC DISTORTION
vs
OUTPUT VOLTAGE SWING

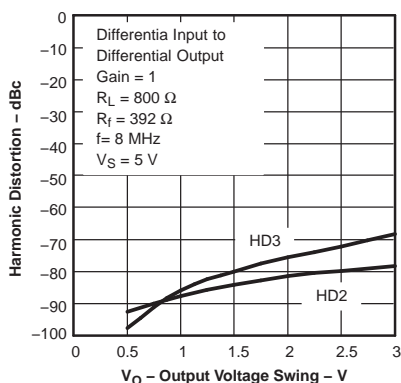

Figure 60.

HARMONIC DISTORTION
vs
OUTPUT VOLTAGE SWING

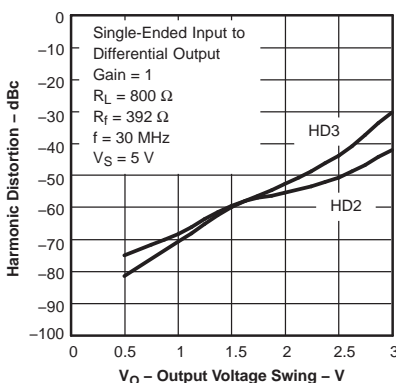

Figure 61.

HARMONIC DISTORTION
vs
OUTPUT VOLTAGE SWING

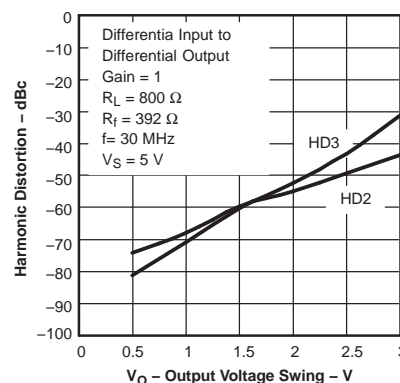

Figure 62.

HARMONIC DISTORTION
vs
FREQUENCY

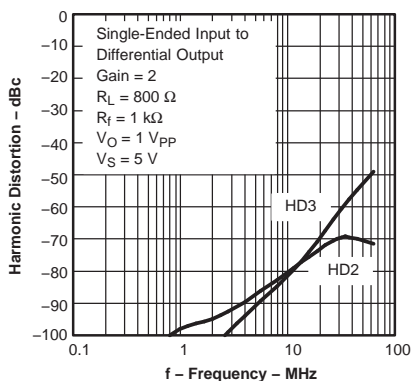

Figure 63.

HARMONIC DISTORTION
vs
FREQUENCY

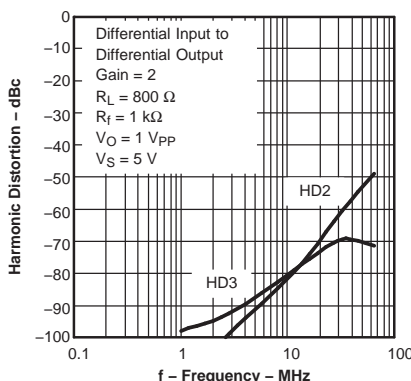

Figure 64.

HARMONIC DISTORTION
vs
FREQUENCY

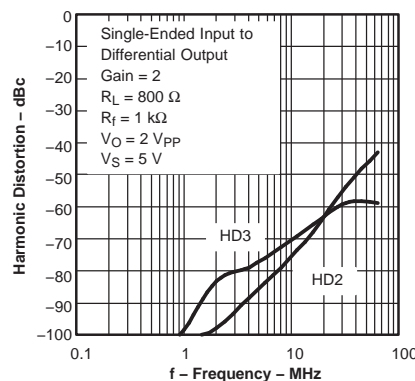

Figure 65.

HARMONIC DISTORTION
vs
FREQUENCY

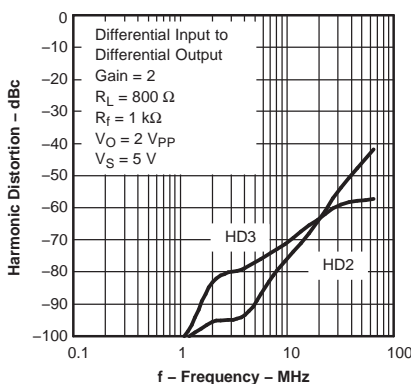

Figure 66.

HARMONIC DISTORTION
vs
OUTPUT VOLTAGE SWING

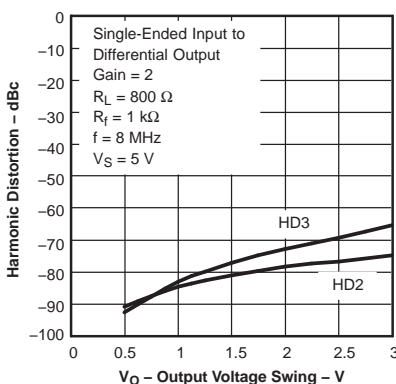

Figure 67.

HARMONIC DISTORTION
vs
OUTPUT VOLTAGE SWING

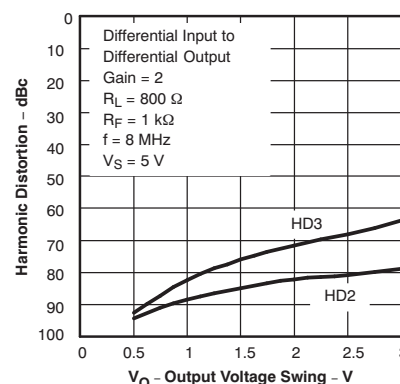

Figure 68.

TYPICAL CHARACTERISTICS: 5 V (continued)

HARMONIC DISTORTION
vs
OUTPUT VOLTAGE SWING

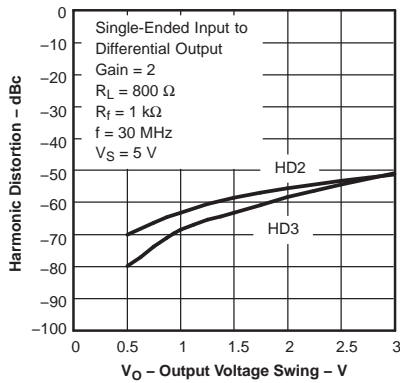

Figure 69.

HARMONIC DISTORTION
vs
OUTPUT VOLTAGE SWING

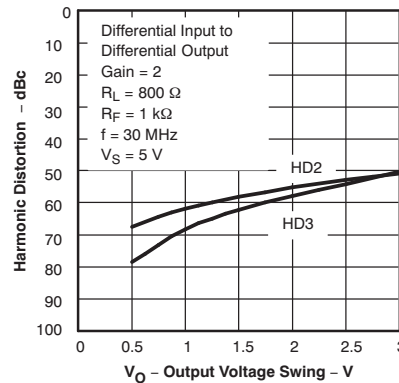

Figure 70.

HARMONIC DISTORTION
vs
LOAD RESISTANCE

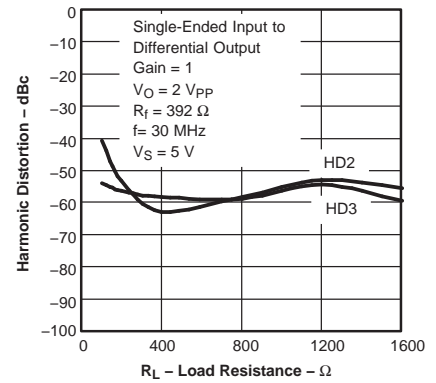

Figure 71.

HARMONIC DISTORTION
vs
LOAD RESISTANCE

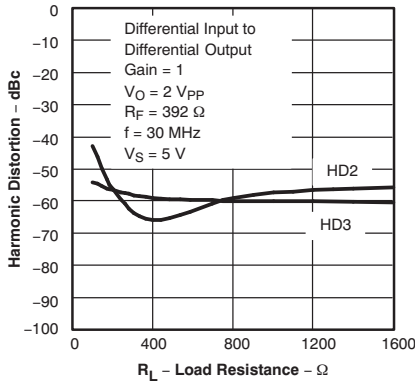

Figure 72.

THIRD-ORDER INTERMODULATION
DISTORTION
vs
FREQUENCY

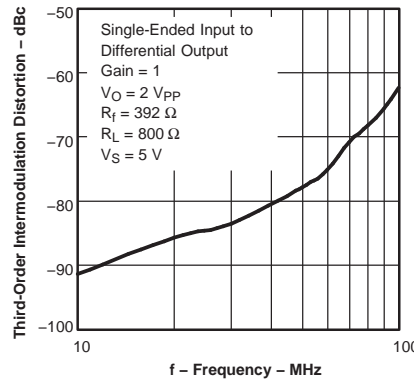

Figure 73.

THIRD-ORDER OUTPUT INTERCEPT
POINT
vs
FREQUENCY

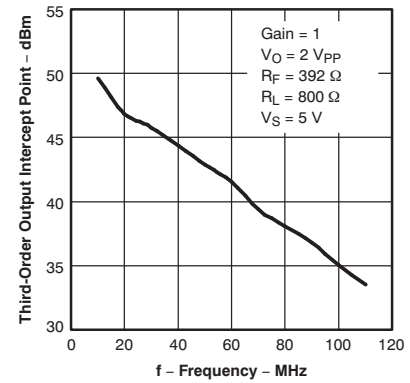

Figure 74.

SLEW RATE
vs
DIFFERENTIAL OUTPUT VOLTAGE
STEP

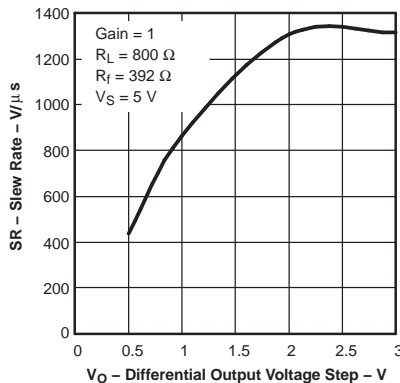

Figure 75.

LARGE-SIGNAL TRANSIENT
RESPONSE

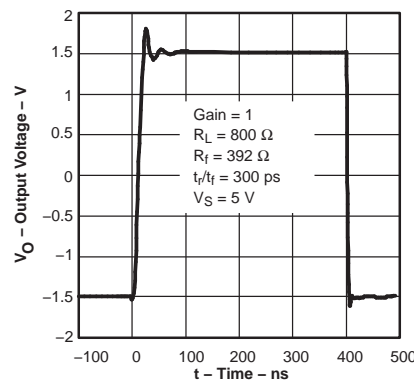

Figure 76.

SMALL-SIGNAL TRANSIENT
RESPONSE

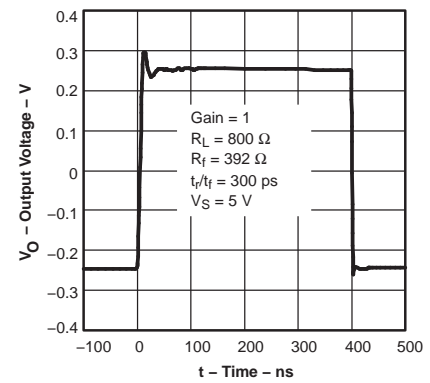

Figure 77.

TYPICAL CHARACTERISTICS: 5 V (continued)

VOLTAGE AND CURRENT NOISE
VS
FREQUENCY

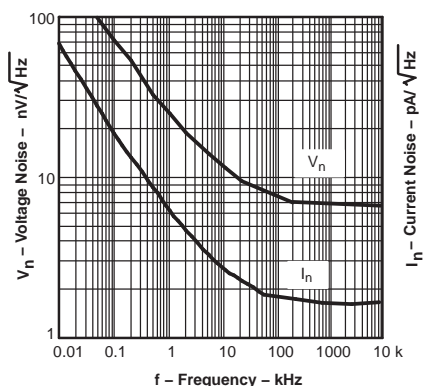

Figure 78.

REJECTION RATIOS
VS
FREQUENCY

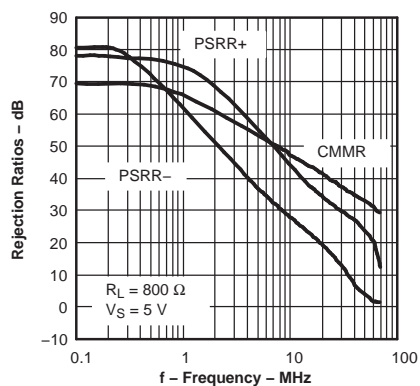

Figure 79.

REJECTION RATIOS
VS
CASE TEMPERATURE

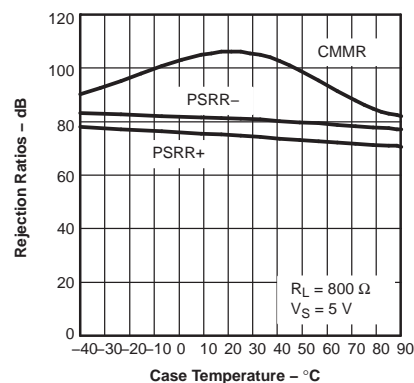

Figure 80.

OUTPUT BALANCE ERROR
VS
FREQUENCY

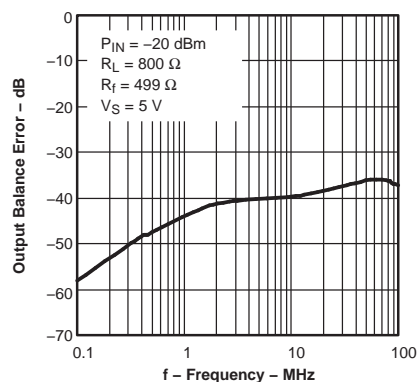

Figure 81.

OPEN-LOOP GAIN AND PHASE
VS
FREQUENCY

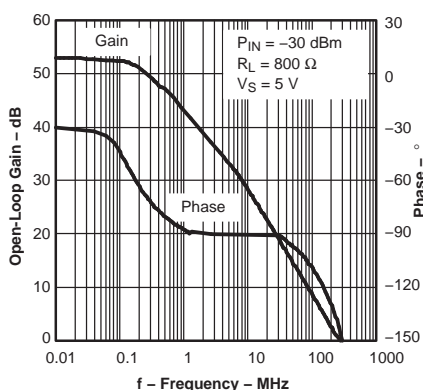

Figure 82.

OPEN-LOOP GAIN
VS
CASE TEMPERATURE

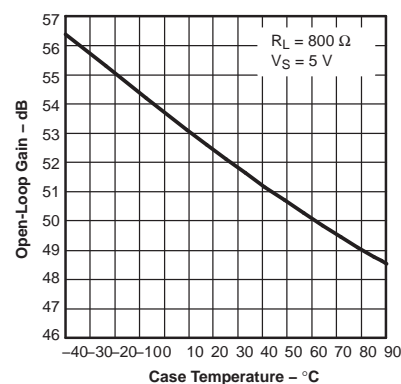

Figure 83.

INPUT BIAS AND OFFSET CURRENT
VS
CASE TEMPERATURE

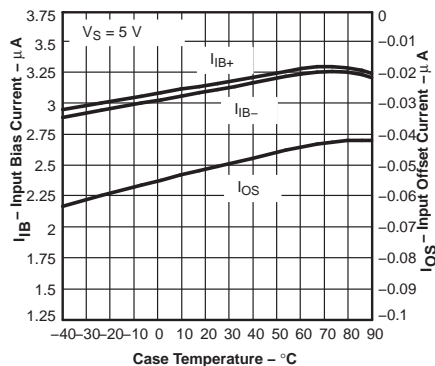

Figure 84.

QUIESCENT CURRENT
VS
SUPPLY VOLTAGE

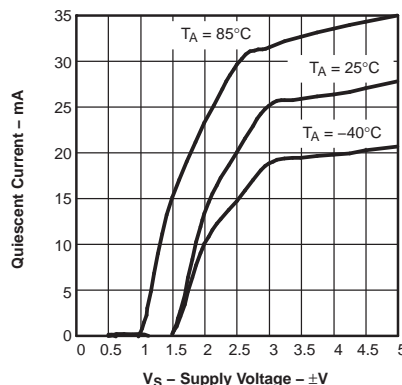

Figure 85.

INPUT OFFSET VOLTAGE
VS
CASE TEMPERATURE

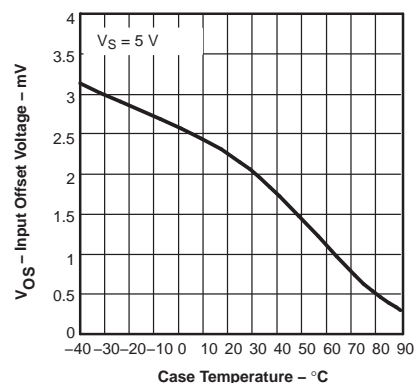

Figure 86.

TYPICAL CHARACTERISTICS: 5 V (continued)

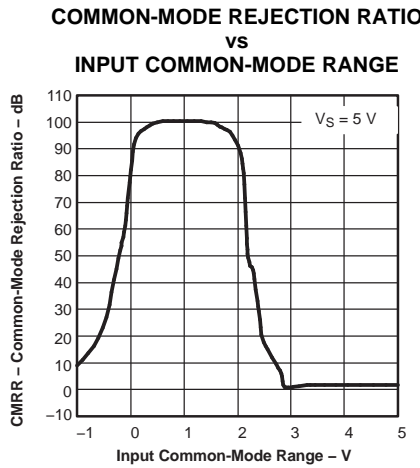

Figure 87.

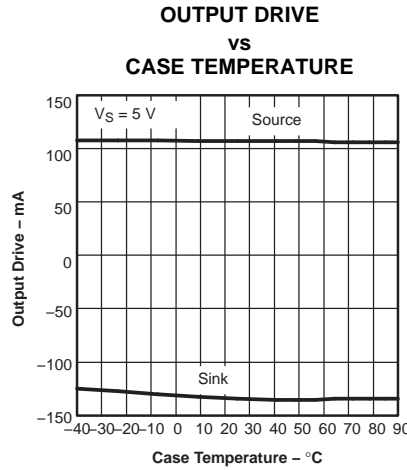

Figure 88.

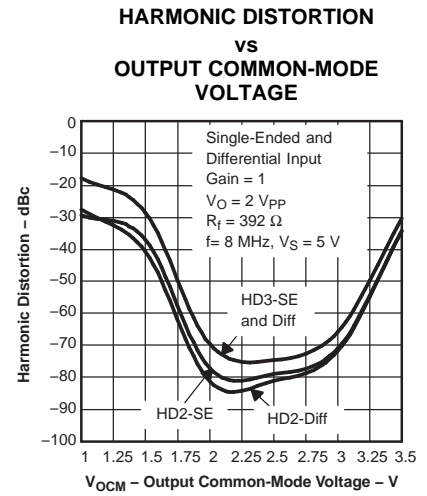

Figure 89.

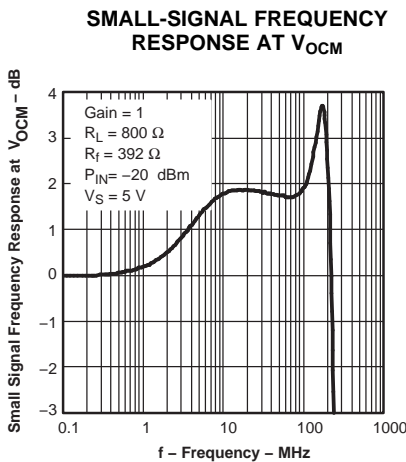

Figure 90.

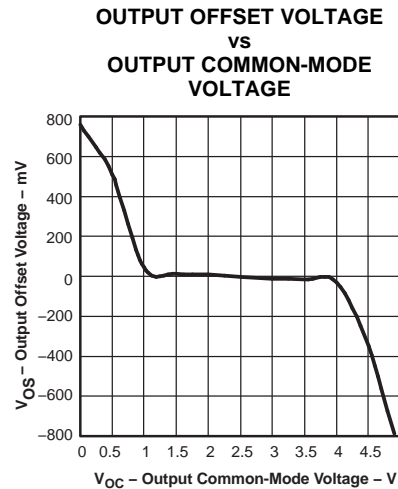

Figure 91.

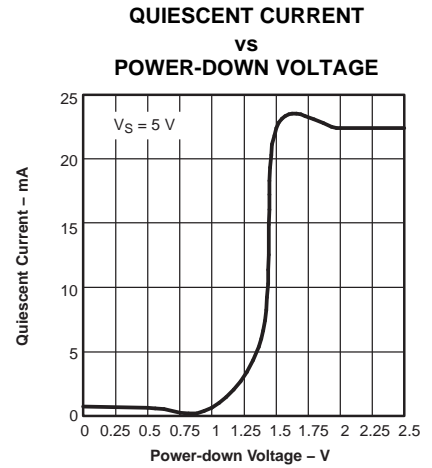

Figure 92.

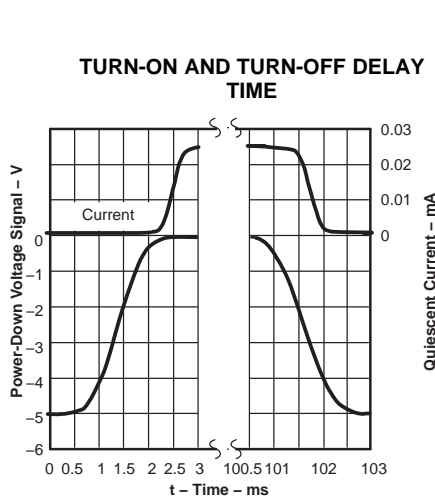

Figure 93.

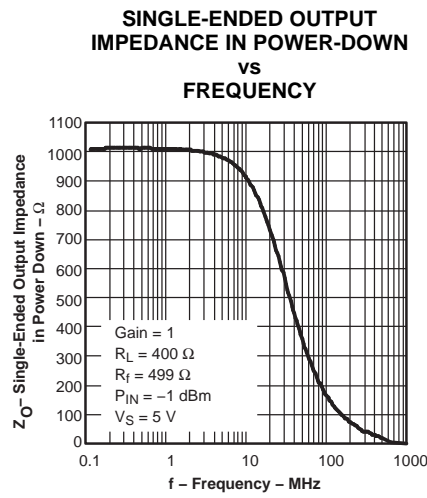

Figure 94.

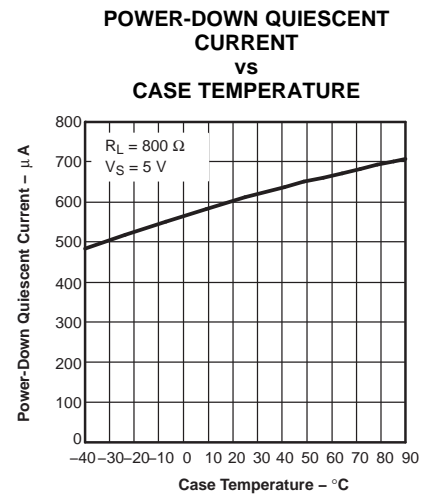

Figure 95.

TYPICAL CHARACTERISTICS: 5 V (continued)
POWER-DOWN QUIESCENT CURRENT
VS
SUPPLY VOLTAGE

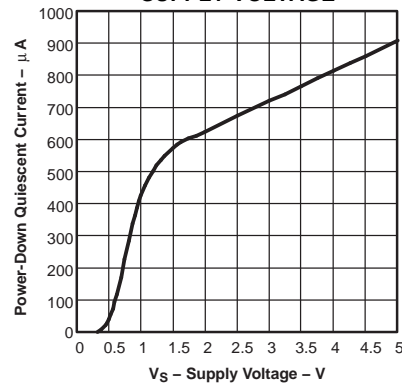

Figure 96.

APPLICATION INFORMATION

FULLY DIFFERENTIAL AMPLIFIERS

Differential signaling offers a number of performance advantages in high-speed analog signal processing systems, including immunity to external common-mode noise, suppression of even-order nonlinearities, and increased dynamic range. Fully differential amplifiers not only serve as the primary means of providing gain to a differential signal chain, but also provide a monolithic solution for converting single-ended signals into differential signals for easier, higher performance processing. The THS4500 family of amplifiers contains products in Texas Instruments' expanding line of high-performance, fully differential amplifiers. Information on fully differential amplifier fundamentals, as well as implementation specific information, is presented in the [Applications Section](#) of this data sheet to provide a better understanding of the operation of the THS4500 family of devices, and to simplify the design process for designs using these amplifiers.

APPLICATIONS SECTION

- Fully Differential Amplifier Terminal Functions
- Input Common-Mode Voltage Range and the THS4500 Family
- Choosing the Proper Value for the Feedback and Gain Resistors
- Application Circuits Using Fully Differential Amplifiers
- Key Design Considerations for Interfacing to an Analog-to-Digital Converter
- Setting the Output Common-Mode Voltage With the V_{OCM} Input
- Saving Power with Power-Down Functionality
- Linearity: Definitions, Terminology, Circuit Techniques, and Design Tradeoffs
- An Abbreviated Analysis of Noise in Fully Differential Amplifiers
- Printed-Circuit Board Layout Techniques for Optimal Performance
- Power Dissipation and Thermal Considerations
- Power Supply Decoupling Techniques and Recommendations
- Evaluation Fixtures, Spice Models, and Applications Support
- Additional Reference Material

FULLY DIFFERENTIAL AMPLIFIER TERMINAL FUNCTIONS

Fully differential amplifiers are typically packaged in eight-pin packages, as shown in [Figure 97](#). The device pins include two inputs (V_{IN+} , V_{IN-}), two outputs (V_{OUT-} , V_{OUT+}), two power supplies (V_{S+} , V_{S-}), an output common-mode control pin (V_{OCM}), and an optional power-down pin (\overline{PD}).

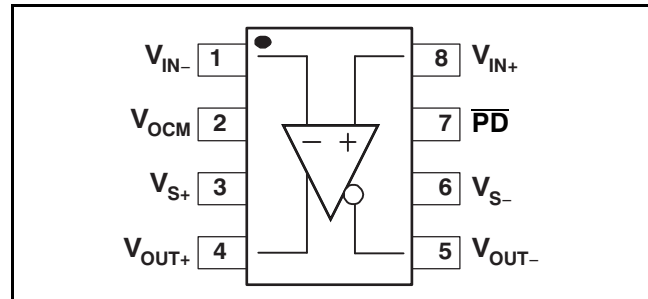

Figure 97. Fully Differential Amplifier Pin Diagram

A standard configuration for the device is shown in [Figure 97](#). The functionality of a fully differential amplifier can be imagined as two inverting amplifiers that share a common noninverting terminal (though the voltage is not necessarily fixed). For more information on the basic theory of operation for fully differential amplifiers, refer to the Texas Instruments application note *Fully Differential Amplifiers*, literature number [SLOA054](#), available for download at [www.ti.com](#).

INPUT COMMON-MODE VOLTAGE RANGE AND THE THS4500 FAMILY

The key difference between the THS4500/1 and the [THS4502/3](#) is the input common-mode range for the four devices. The THS4502 and THS4503 have an input common-mode range that is centered around midrail, and the THS4500 and THS4501 have an input common-mode range that is shifted to include the negative power-supply rail. Selection of one or the other amplifier is determined by the nature of the application. Specifically, the THS4500 and THS4501 are designed for use in single-supply applications where the input signal is ground-referenced, as depicted in [Figure 98](#). The THS4502 and THS4503 are designed for use in single-supply or split-supply applications where the input signal is centered between the power-supply voltages, as depicted in [Figure 99](#).

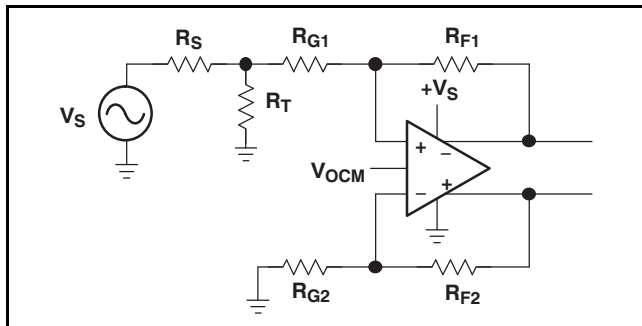

Figure 98. Application Circuit for the THS4500 and THS4501, Featuring Single-Supply Operation With a Ground-Reference Input Signal

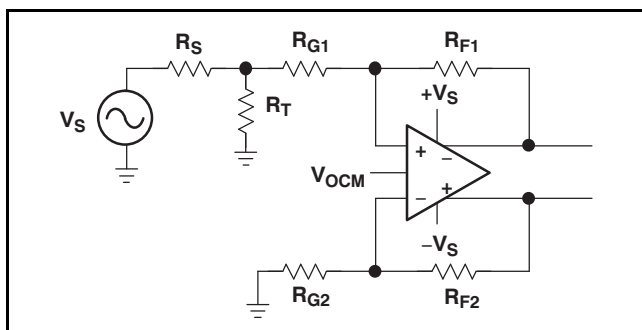

Figure 99. Application Circuit for the THS4500 and THS4501, Featuring Split-Supply Operation With an Input Signal Referenced at the Midrail

Equation 1 through Equation 5 are used to calculate the required input common-mode range for a given set of input conditions.

The equations allow calculation of the input common-mode range requirements, given information about the input signal, the output voltage swing, the gain, and the output common-mode voltage. Calculating the maximum and minimum voltage required for V_N and V_P (the amplifier input nodes) determines whether or not the input common-mode range is violated or not. Four equations are required: two calculate the output voltages and two calculate the node voltages at V_N and V_P (note that only one of these nodes needs calculation, because the amplifier forces a virtual short between the two nodes).

$$V_{OUT+} = \frac{V_{IN+}(1-\beta) - V_{IN-}(1-\beta) + 2V_{OCM}\beta}{2\beta} \quad (1)$$

$$V_{OUT-} = \frac{-V_{IN+}(1-\beta) + V_{IN-}(1-\beta) + 2V_{OCM}\beta}{2\beta} \quad (2)$$

$$V_N = V_{IN-}(1-\beta) + V_{OUT+}\beta \quad (3)$$

Where:

$$\beta = \frac{R_G}{R_F + R_G} \quad (4)$$

$$V_P = V_{IN+}(1-\beta) + V_{OUT-}\beta$$

NOTE: The equations denote the device inputs as V_N and V_P , and the circuit inputs as V_{IN+} and V_{IN-} . (5)

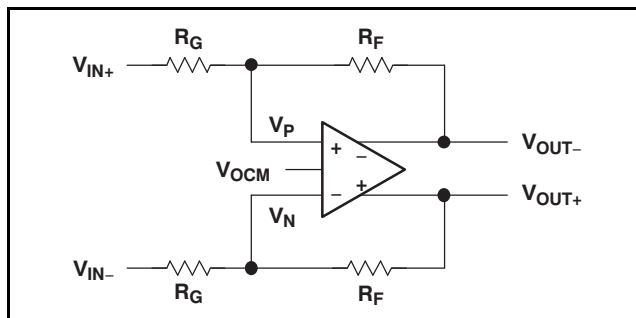

Figure 100. Diagram For Input Common-Mode Range Equations

Table 1 and Table 2 depict the input common-mode range requirements for two different input scenarios, an input referenced around the negative rail and an input referenced around midrail. The tables highlight the differing requirements on input common-mode range, and illustrate the reasoning to choose either the THS4500/1 or the THS4502/3. For signals referenced around the negative power supply, the THS4500/1 should be chosen because its input common-mode range includes the negative supply rail. For all other situations, the THS4502/3 offers slightly improved distortion and noise performance for applications with input signals centered between the power-supply rails.

Table 1. Negative-Rail Referenced

| Gain (V/V) | V_{IN+} (V) | V_{IN-} (V) | V_{IN} (V _{PP}) | V_{OCM} (V) | V_{OD} (V _{PP}) | V_{NMIN} (V) | V_{NMAX} (V) |
|------------|---------------|---------------|-----------------------------|---------------|-----------------------------|----------------|----------------|
| 1 | -2.0 to 2.0 | 0 | 4 | 2.5 | 4 | 0.75 | 1.75 |
| 2 | -1.0 to 1.0 | 0 | 2 | 2.5 | 4 | 0.5 | 1.167 |
| 4 | -0.5 to 0.5 | 0 | 1 | 2.5 | 4 | 0.3 | 0.7 |
| 8 | -0.25 to 0.25 | 0 | 0.5 | 2.5 | 4 | 0.167 | 0.389 |

Table 2. Midrail Referenced

| Gain (V/V) | V _{IN+} (V) | V _{IN-} (V) | V _{IN} (V _{PP}) | V _{OCM} (V) | V _{OD} (V _{PP}) | V _{NMIN} (V) | V _{NMAX} (V) |
|------------|----------------------|----------------------|------------------------------------|----------------------|------------------------------------|-----------------------|-----------------------|
| 1 | 0.5 to 4.5 | 2.5 | 4 | 2.5 | 4 | 2 | 3 |
| 2 | 1.5 to 3.5 | 2.5 | 2 | 2.5 | 4 | 2.16 | 2.83 |
| 4 | 2.0 to 3.0 | 2.5 | 1 | 2.5 | 4 | 2.3 | 2.7 |
| 8 | 2.25 to 2.75 | 2.5 | 0.5 | 2.5 | 4 | 2.389 | 2.61 |

CHOOSING THE PROPER VALUE FOR THE FEEDBACK AND GAIN RESISTORS

The selection of feedback and gain resistors impacts circuit performance in a number of ways. The values presented in this section provide the optimum high-frequency performance (lowest distortion, flat frequency response). Since the THS4500 family of amplifiers is developed with a voltage feedback architecture, the choice of resistor values does not have a dominant effect on bandwidth, unlike a current-feedback amplifier. However, resistor choices do have second-order effects. For optimal performance, the following feedback resistor values are recommended. In higher gain configurations (gain greater than two), the feedback resistor values have much less effect on the high-frequency performance. Example feedback and gain resistor values are given in the section on basic design considerations (Table 3).

Amplifier loading, noise, and the flatness of the frequency response are three design parameters that should be considered when selecting feedback resistors. Larger resistor values contribute more noise and can induce peaking in the ac response in low gain configurations; smaller resistor values can load the amplifier more heavily, resulting in a reduction in distortion performance. In addition, feedback resistor values, coupled with gain requirements, determine the value of the gain resistors and directly impact the input impedance of the entire circuit. While there are no strict rules about resistor selection, these trends can provide qualitative design guidance.

APPLICATION CIRCUITS USING FULLY DIFFERENTIAL AMPLIFIERS

Fully differential amplifiers provide designers with a great deal of flexibility in a wide variety of applications. This section provides an overview of some common circuit configurations and gives some design guidelines. Designing the interface to an analog-to-digital converter (ADC), driving lines differentially, and filtering with fully differential amplifiers are a few of the circuits that are covered.

BASIC DESIGN CONSIDERATIONS

The circuits in Figure 98 through Figure 101 are used to highlight basic design considerations for fully differential amplifier circuit designs.

Table 3. Resistor Values for Balanced Operation in Various Gain Configurations

| Gain ($\frac{V_{OD}}{V_{IN}}$) | R2 and R4 (Ω) | R1 (Ω) | R3 (Ω) | R _T (Ω) |
|----------------------------------|---------------|--------|--------|--------------------|
| 1 | 392 | 412 | 383 | 54.9 |
| 1 | 499 | 523 | 487 | 53.6 |
| 2 | 392 | 215 | 187 | 60.4 |
| 2 | 1.3 k | 665 | 634 | 52.3 |
| 5 | 1.3 k | 274 | 249 | 56.2 |
| 5 | 3.32 k | 681 | 649 | 52.3 |
| 10 | 1.3 k | 147 | 118 | 64.9 |
| 10 | 6.81 k | 698 | 681 | 52.3 |

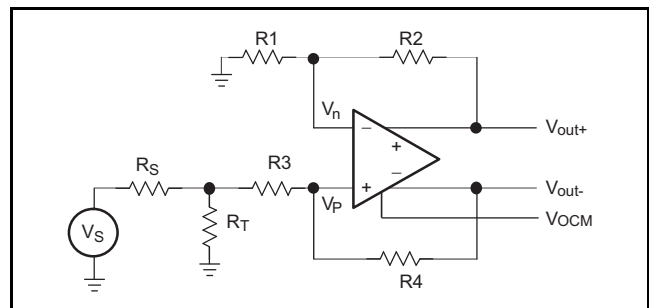

Figure 101. Diagram for Design Calculations

Equations for calculating fully differential amplifier resistor values in order to obtain balanced operation in the presence of a 50-Ω source impedance are given in Equation 6 through Equation 9.

$$R_T = \frac{1}{\frac{1}{R_S} - \frac{1 - K}{2(1 + K)}} \quad K = \frac{R_2}{R_1} \quad R_2 = R_4$$

$$R_3 = R_1 - (R_S \parallel R_T) \tag{6}$$

$$\beta_1 = \frac{R_1}{R_1 + R_2} \quad \beta_2 = \frac{R_3 + R_T \parallel R_S}{R_3 + R_T \parallel R_S + R_4} \tag{7}$$

$$\frac{V_{OD}}{V_S} = 2 \left(\frac{1 - \beta_2}{\beta_1 + \beta_2} \right) \left(\frac{R_T}{R_T + R_S} \right) \tag{8}$$

$$\frac{V_{OD}}{V_{IN}} = 2 \left(\frac{1 - \beta_2}{\beta_1 + \beta_2} \right) \tag{9}$$

For more detailed information about balance in fully differential amplifiers, see the application report, *Fully Differential Amplifiers* (SLOA054), referenced at the end of this data sheet.

INTERFACING TO AN ANALOG-TO-DIGITAL CONVERTER

The THS4500 family of amplifiers are designed specifically to interface to today's highest-performance ADCs. This section highlights the key concerns when interfacing to an ADC and provides example interface circuits.

There are several key design concerns when interfacing to an analog-to-digital converter:

- Terminate the input source properly. In high-frequency receiver chains, the source that feeds the fully differential amplifier requires a specific load impedance (that is, 50 Ω).
- Design a symmetric printed circuit board (PCB) layout. Even-order distortion products are heavily influenced by layout, and careful attention to a symmetric layout minimizes these distortion products.
- Minimize inductance in power-supply decoupling traces and components. Poor power-supply decoupling can have a dramatic effect on circuit performance. Since the outputs are differential, differential currents exist in the power-supply pins. Thus, decoupling capacitors should be placed in a manner that minimizes the impedance of the current loop.
- Use separate analog and digital power supplies and grounds. Noise (bounce) in the power supplies (created by digital switching currents) can couple directly into the signal path, and power-supply noise can create higher distortion products as well.
- Use care when filtering. While an RC low-pass filter may be desirable on the output of the amplifier to filter broadband noise, the excess loading can negatively impact the amplifier linearity. Filtering in the feedback path does not have this effect.
- AC-coupling allows easier circuit design. If dc-coupling is required, be aware of the excess power dissipation that can occur due to level-shifting the output through the output common-mode voltage control.
- Do not terminate the output unless required. Many open-loop, class-A amplifiers require 50- Ω termination for proper operation, but closed-loop fully differential amplifiers drive a specific output

voltage regardless of the load impedance present. Terminating the output of a fully differential amplifier with a heavy load adversely affects the amplifier linearity.

- Comprehend the V_{OCM} input drive requirements. Determine if the ADC voltage reference can provide the required amount of current to move V_{OCM} to the desired value. A buffer may be needed.
- Decouple the V_{OCM} pin to eliminate the antenna effect. V_{OCM} is a high-impedance node that can act as an antenna. A large decoupling capacitor on this node eliminates this problem.
- Know the input common-mode range. If the input signal is referenced around the negative power-supply rail (for example, around ground on a single 5 V supply), then the THS4500/1 accommodates the input signal. If the input signal is referenced around midrail, choose the THS4502/3 for the best operation.
- Packaging makes a difference at higher frequencies. If possible, choose the smaller, thermally-enhanced MSOP package for the best performance. As a rule, lower junction temperatures provide better performance. If possible, use a thermally-enhanced package, even if the power dissipation is relatively small compared to the maximum power dissipation rating to achieve the best results.
- Understand the effect of the load impedance seen by the fully differential amplifier when performing system-level intercept point calculations. Lighter loads (such as those presented by an ADC) allow smaller intercept points to support the same level of intermodulation distortion performance.

EXAMPLE ANALOG-TO-DIGITAL CONVERTER DRIVER CIRCUITS

The THS4500 family of devices is designed to drive high-performance ADCs with extremely high linearity, allowing for the maximum effective number of bits at the output of the data converter. Two representative circuits shown below highlight single-supply operation and split supply operation, respectively. Specific feedback resistor, gain resistor, and feedback capacitor values are not shown, as these values depend on the frequency of interest. Information on calculating these values can be found in the applications material above.

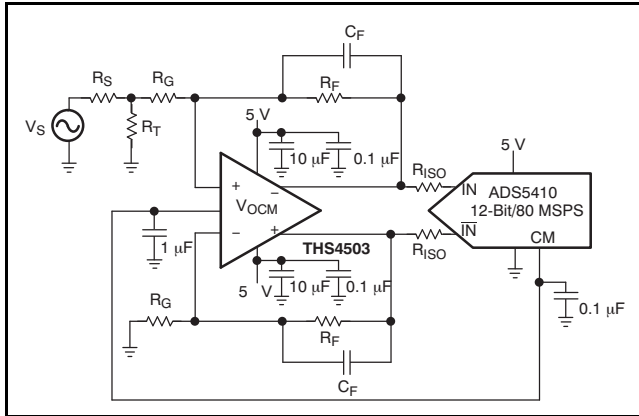

Figure 102. Using the THS4503 With the [ADS5410](#)

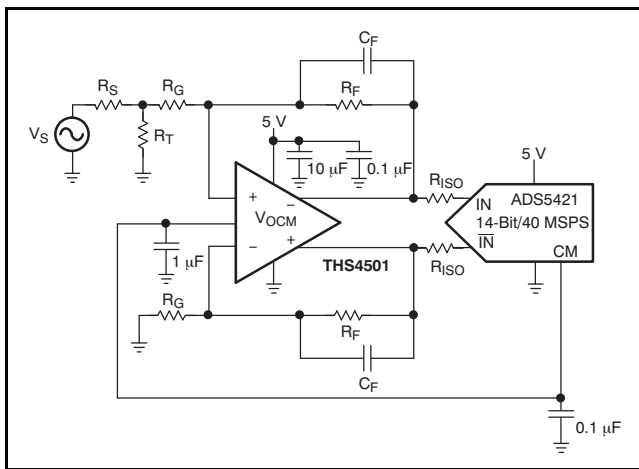

Figure 103. Using the THS4501 With the [ADS5421](#)

FULLY DIFFERENTIAL LINE DRIVERS

The THS4500 family of amplifiers can be used as high-frequency, high-swing differential line drivers. The high power-supply voltage rating (16.5 V absolute maximum) allows operation on a single 12-V or a single 15-V supply. The high supply voltage, coupled with the ability to provide differential outputs, enables the ability to drive 26 V_{PP} into reasonably heavy loads (250 Ω or greater). The circuit in [Figure 104](#) illustrates the THS4500 family of devices used as high-speed line drivers. For line driver applications, close attention must be paid to thermal design constraints because of the typically high level of power dissipation.

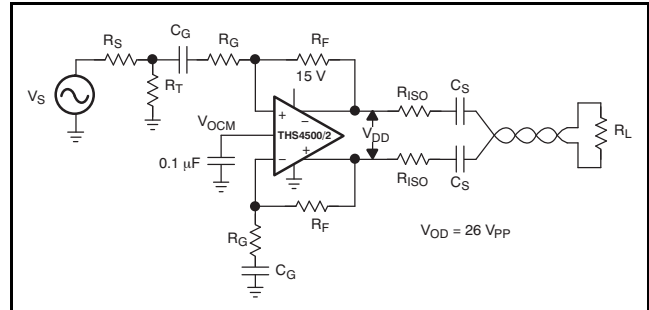

Figure 104. Fully Differential Line Driver With High Output Swing

FILTERING WITH FULLY DIFFERENTIAL AMPLIFIERS

Similar to single-ended counterparts, fully differential amplifiers have the ability to couple filtering functionality with voltage gain. Numerous filter topologies can be based on fully differential amplifiers. Several of these are outlined in the application report *A Differential Circuit Collection* (literature number [SLOA064](#)), referenced at the end of this data sheet. The circuit below depicts a simple, two-pole, low-pass filter applicable to many different types of systems. The first pole is set by the resistors and capacitors in the feedback paths, and the second pole is set by the isolation resistors and the capacitor across the outputs of the isolation resistors.

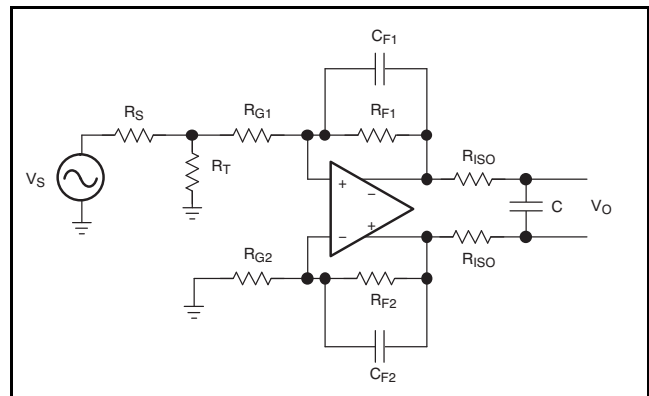

Figure 105. A Two-Pole, Low-Pass Filter Design Using a Fully Differential Amplifier With Poles Located at: $P1 = (2\pi R_F C_F)^{-1}$ in Hz and $P2 = (4\pi R_{ISO} C)^{-1}$ in Hz

Often, filters like these are used to eliminate broadband noise and out-of-band distortion products in signal acquisition systems. It should be noted that the increased load placed on the output of the amplifier by the second low-pass filter has a

detrimental effect on the distortion performance. The preferred method of filtering is to use the feedback network, as the typically smaller capacitances required at these points in the circuit do not load the amplifier nearly as heavily in the passband.

SETTING THE OUTPUT COMMON-MODE VOLTAGE WITH THE V_{OCM} INPUT

The output common-mode voltage pin provides a critical function to the fully differential amplifier; it accepts an input voltage and reproduces that input voltage as the output common-mode voltage. In other words, the V_{OCM} input provides the ability to level-shift the outputs to any voltage inside the output voltage swing of the amplifier.

A description of the input circuitry of the V_{OCM} pin is shown in Figure 106 to facilitate an easier understanding of the V_{OCM} interface requirements. The V_{OCM} pin has two 50-k Ω resistors between the power supply rails to set the default output common-mode voltage to midrail. A voltage applied to the V_{OCM} pin alters the output common-mode voltage as long as the source has the ability to provide enough current to overdrive the two 50-k Ω resistors. This phenomenon is depicted in the V_{OCM} equivalent circuit diagram. Current drive is especially important when using the reference voltage of an analog-to-digital converter to drive V_{OCM} . Output current drive capabilities differ from part to part, so a voltage buffer may be necessary in some applications.

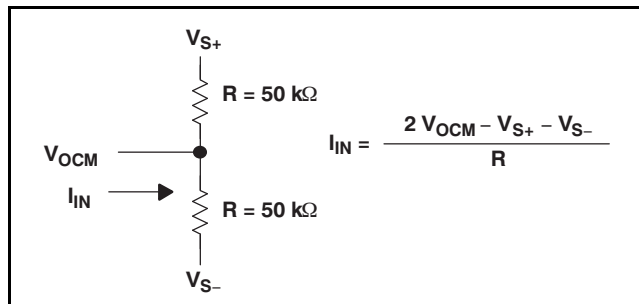

Figure 106. Equivalent Input Circuit for V_{OCM}

By design, the input signal applied to the V_{OCM} pin propagates to the outputs as a common-mode signal. As shown in Figure 106, the V_{OCM} input has a high impedance associated with it, dictated by the two 50-k Ω resistors. While the high impedance allows for relaxed drive requirements, it also allows the pin and any associated PCB traces to act as an antenna. For this reason, a decoupling capacitor is recommended on this node for the sole purpose of filtering any high-frequency noise that could couple into the signal path through the V_{OCM} circuitry. A 0.1- μ F or 1- μ F

capacitance is a reasonable value for eliminating a great deal of broadband interference, but additional, tuned decoupling capacitors should be considered if a specific source of electromagnetic or radio frequency interference is present elsewhere in the system. Information on the ac performance (bandwidth, slew rate) of the V_{OCM} circuitry is included in the [Electrical Characteristics](#) and [Typical Characteristics](#) sections.

Since the V_{OCM} pin provides the ability to set an output common-mode voltage, the ability for increased power dissipation exists. While this possibility does not pose a performance problem for the amplifier, it can cause additional power dissipation of which the system designer should be aware. The circuit shown in Figure 107 demonstrates an example of this phenomenon. For a device operating on a single 5-V supply with an input signal referenced around ground and an output common-mode voltage of 2.5 V, a dc potential exists between the outputs and the inputs of the device. The amplifier sources current into the feedback network in order to provide the circuit with the proper operating point. While there are no serious effects on the circuit performance, the extra power dissipation may need to be included in the system power budget.

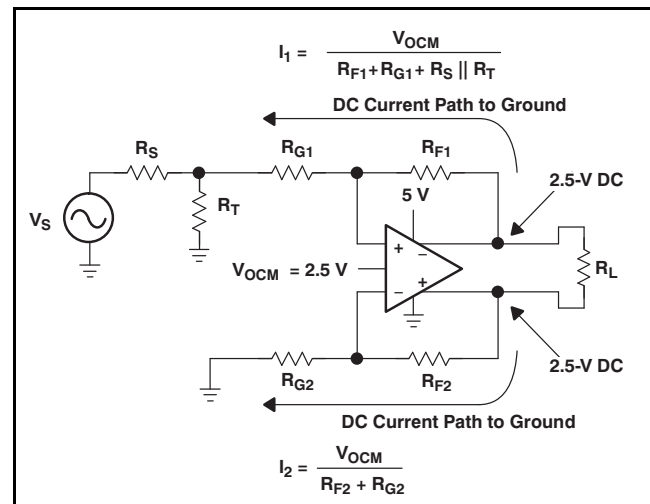

Figure 107. Depiction of DC Power Dissipation Caused By Output Level-Shifting in a DC-Coupled Circuit

SAVING POWER WITH POWER-DOWN FUNCTIONALITY

The THS4500 family of fully differential amplifiers contains devices that come with and without the power-down option. Even-numbered devices have power-down capability, which is described in detail here.

The power-down pin of the amplifiers defaults to the positive supply voltage in the absence of an applied voltage (that is, an internal pull-up resistor is present), putting the amplifier in the *power-on* mode of operation. To turn off the amplifier in an effort to conserve power, the power-down pin can be driven towards the negative rail. The threshold voltages for power-on and power-down are relative to the supply rails and given in the specification tables. Above the *enable threshold voltage*, the device is on. Below the *disable threshold voltage*, the device is off. Behavior between these threshold voltages is not specified.

Note that this power-down functionality is just that; the amplifier consumes less power in power-down mode. The power-down mode is not intended to provide a high-impedance output. In other words, the power-down functionality is not intended to allow use as a 3-state bus driver. When in power-down mode, the impedance looking back into the output of the amplifier is dominated by the feedback and gain setting resistors.

The time delays associated with turning the device on and off are specified as the time it takes for the amplifier to reach 50% of the nominal quiescent current. The time delays are on the order of microseconds because the amplifier moves in and out of the linear mode of operation in these transitions.

LINEARITY: DEFINITIONS, TERMINOLOGY, CIRCUIT TECHNIQUES, AND DESIGN TRADEOFFS

The THS4500 family of devices features unprecedented distortion performance for monolithic fully differential amplifiers. This section focuses on the fundamentals of distortion, circuit techniques for reducing nonlinearity, and methods for equating distortion of fully differential amplifiers to desired linearity specifications in RF receiver chains.

Amplifiers are generally thought of as *linear* devices. In other words, the output of an amplifier is a linearly scaled version of the input signal applied to it. In reality, however, amplifier transfer functions are nonlinear. Minimizing amplifier nonlinearity is a primary design goal in many applications.

Intercept points are specifications that have long been used as key design criteria in the RF communications world as a metric for the intermodulation distortion performance of a device in the signal chain (for example, amplifiers, mixers,

etc.). Use of the intercept point, rather than strictly the intermodulation distortion, allows for simpler system-level calculations. Intercept points, like noise figures, can be easily cascaded back and forth through a signal chain to determine the overall receiver chain intermodulation distortion performance. The relationship between intermodulation distortion and intercept point is depicted in Figure 108 and Figure 109.

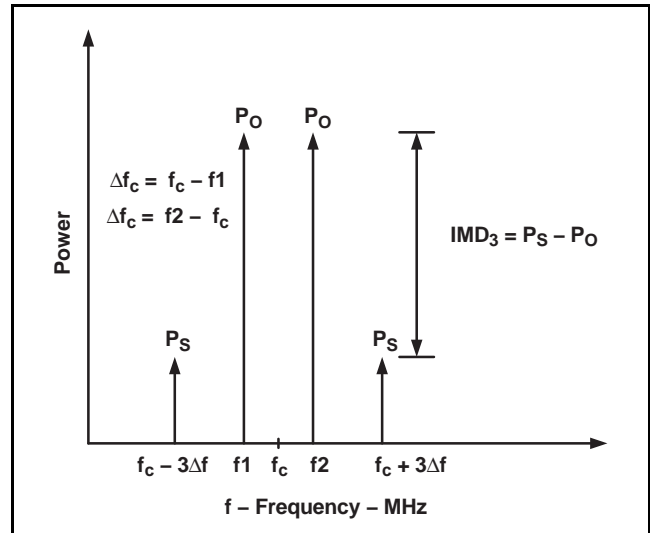

Figure 108. 2-Tone and 3rd-Order Intermodulation Products

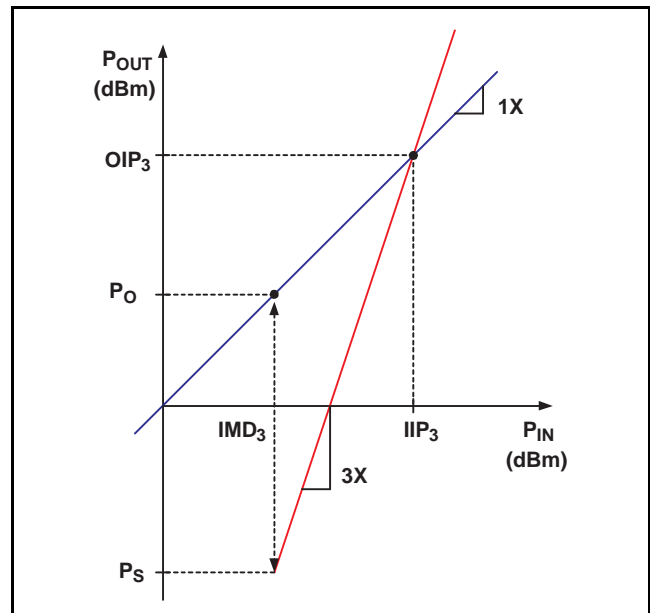

Figure 109. Graphical Representation of 2-Tone and 3rd-Order Intercept Point

Due to the intercept point ease-of-use in system level calculations for receiver chains, it has become the specification of choice for guiding distortion-related

design decisions. Traditionally, these systems use primarily class-A, single-ended RF amplifiers as gain blocks. These RF amplifiers are typically designed to operate in a 50-Ω environment, just like the rest of the receiver chain. Since intercept points are given in dBm, this implies an associated impedance (50 Ω).

However, with a fully differential amplifier, the output does not require termination as an RF amplifier would. Because closed-loop amplifiers deliver signals to the outputs regardless of the impedance present, it is important to comprehend this feature when evaluating the intercept point of a fully differential amplifier. The THS4500 series of devices yields optimum distortion performance when loaded with 200 Ω to 1 kΩ, very similar to the input impedance of an analog-to-digital converter over its input frequency band. As a result, terminating the input of the ADC to 50 Ω can actually be detrimental to system performance.

This discontinuity between open-loop, class-A amplifiers and closed-loop, class-AB amplifiers becomes apparent when comparing the intercept points of the two types of devices. Equation 10 gives the definition of an intercept point, relative to the intermodulation distortion.

$$OIP_3 = P_o + \left(\frac{|IMD_3|}{2} \right) \text{ where} \tag{10}$$

$$P_o = 10 \log \left(\frac{V_{P(diff)}^2}{2R_L \times 0.001} \right)$$

NOTE: P_o is the output power of a single tone, R_L is the differential load resistance, and $V_{P(diff)}$ is the differential peak voltage for a single tone. (11)

As can be seen in the equations, when a higher impedance is used, the same level of intermodulation distortion performance results in a lower intercept point. Therefore, it is important to understand the impedance seen by the output of the fully differential amplifier when selecting a minimum intercept point. Figure 110 shows the relationship between the strict definition of an intercept point with a normalized, or equivalent, intercept point for the THS4500.

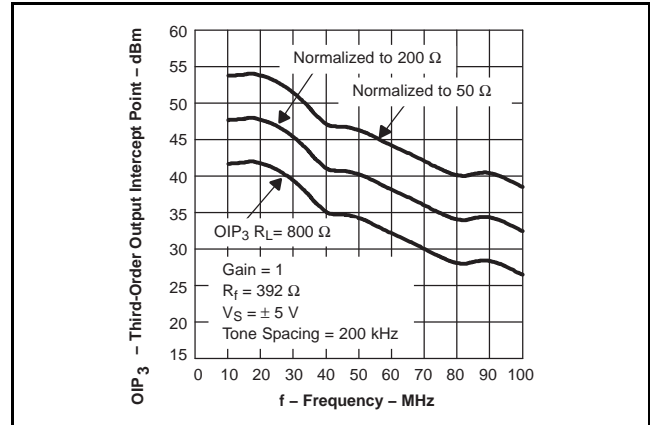

Figure 110. Equivalent 3rd-Order Intercept Point for the THS4500

Comparing specifications between different device types becomes easier when a common impedance level is assumed. For this reason, the intercept points on the THS4500 family of devices are reported normalized to a 50-Ω load impedance.

AN ANALYSIS OF NOISE IN FULLY DIFFERENTIAL AMPLIFIERS

Noise analysis in fully differential amplifiers is analogous to noise analysis in single-ended amplifiers; the same concepts apply. Figure 111 shows a generic circuit diagram consisting of a voltage source, a termination resistor, two gain setting resistors, two feedback resistors, and a fully differential amplifier is shown, including all the relevant noise sources. From this circuit, the noise factor (F) and noise figure (NF) are calculated. The figures indicate the appropriate scaling factor for each of the noise sources in two different cases. The first case includes the termination resistor, and the second, simplified case assumes that the voltage source is properly terminated by the gain-setting resistors. With these scaling factors, the amplifier input noise power (N_A) can be calculated by summing each individual noise source with its scaling factor. The noise delivered to the amplifier by the source (N_i) and input noise power are used to calculate the noise factor and noise figure as shown in Equation 23 through Equation 27.

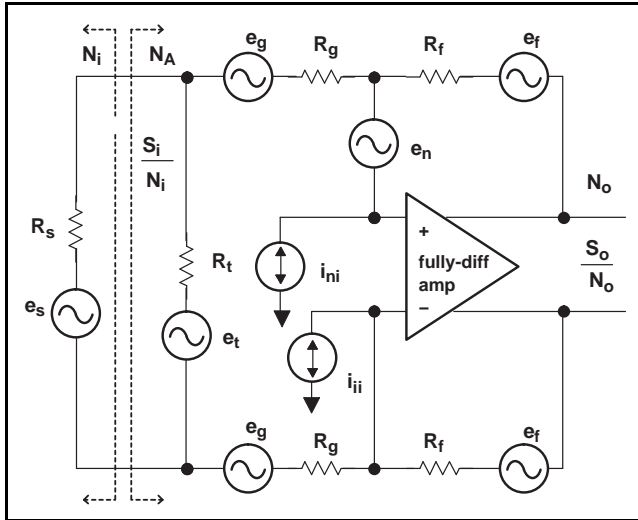

Figure 111. Noise Sources in a Fully Differential Amplifier Circuit

Scaling Factors for Individual Noise Sources Assuming a Finite Value Termination Resistor

N_A: Fully Differential Amplifier

Noise Source Scale Factor

$$(e_{ni})^2 \left[\frac{R_g}{R_f} + \frac{R_g}{R_g + \frac{R_s R_t}{2(R_s + R_t)}} \right]^2 \quad (12)$$

$$(i_{ni})^2 R_g^2 \quad (13)$$

$$(i_{ji})^2 R_g^2 \quad (14)$$

$$4kTR_t \left[\frac{2R_s R_g}{R_s + 2R_g} \right]^2 \frac{R_g}{R_t + \frac{2R_s R_g}{R_s + 2R_g}} \quad (15)$$

$$4kTR_f 2 \times \left(\frac{R_g}{R_f} \right)^2 \quad (16)$$

$$4kTR_g 2 \times \left[\frac{R_g}{R_g + \frac{R_s R_t}{2(R_s + R_t)}} \right]^2 \quad (17)$$

Scaling Factors for Individual Noise Sources Assuming No Termination Resistance is Used (that is, R_T is Open)

N_A: Fully Differential Amplifier; termination = 2R_g

Noise Source Scale Factor

$$(e_{ni})^2 \left[\frac{R_g}{R_f} + \frac{R_g}{R_g + \frac{R_s}{2}} \right]^2 \quad (18)$$

$$(i_{ni})^2 R_g^2 \quad (19)$$

$$(i_{ji})^2 R_g^2 \quad (20)$$

$$4kTR_f 2 \times \left(\frac{R_g}{R_f} \right)^2 \quad (21)$$

$$4kTR_g 2 \times \left[\frac{R_g}{R_g + \frac{R_s}{2}} \right]^2 \quad (22)$$

Input Noise With a Termination Resistor

$$N_i = 4kTR_s \left[\frac{2R_t R_g}{R_t + 2R_g} \right]^2 \frac{R_g}{R_s + \frac{2R_t R_g}{R_t + 2R_g}} \quad (23)$$

Input Noise Assuming No Termination Resistor

$$N_i = 4kTR_s \left[\frac{2R_g}{R_s + 2R_g} \right]^2 \quad (24)$$

Noise Factor and Noise Figure Calculations

$$N_A = \sum(\text{Noise Source} \times \text{Scale Factor}) \quad (25)$$

$$F = 1 + \frac{N_A}{N_i} \quad (26)$$

$$NF = 10 \log(F) \quad (27)$$

PRINTED CIRCUIT BOARD LAYOUT TECHNIQUES FOR OPTIMAL PERFORMANCE

Achieving optimum performance with high frequency amplifier-like devices in the THS4500 family requires careful attention to PCB layout parasitic and external component types.

Recommendations that optimize performance include:

- Minimize parasitic capacitance to any ac ground for all of the signal I/O pins. Parasitic capacitance on the output and input pins can cause instability. To reduce unwanted capacitance, a window around the signal I/O pins should be opened in all of the ground and power planes around those pins. Otherwise, ground and power planes should be unbroken elsewhere on the board.
- Minimize the distance ($< 0.25''$, 6.35 mm) from the power-supply pins to high frequency 0.1- μF decoupling capacitors. At the device pins, the ground and power-plane layout should not be in close proximity to the signal I/O pins. Avoid narrow power and ground traces to minimize inductance between the pins and the decoupling capacitors. The power supply connections should always be decoupled with these capacitors. Larger (6.8 μF or more) tantalum decoupling capacitors, effective at lower frequency, should also be used on the main supply pins. These may be placed somewhat farther from the device and may be shared among several devices in the same area of the PCB. The primary goal is to minimize the impedance seen in the differential-current return paths.
- Careful selection and placement of external components preserve the high-frequency performance of the THS4500 family. Resistors should be a very low reactance type. Surface-mount resistors work best and allow a tighter overall layout. Metal-film and carbon composition, axially-leaded resistors can also provide good high frequency performance. Again, keep the leads and PCB trace length as short as possible. Never use wirewound type resistors in a high-frequency application. Since the output pin and inverting input pins are the most sensitive to parasitic capacitance, always position the feedback and series output resistors, if any, as close as possible to the inverting input pins and output pins. Other network components, such as input termination resistors, should be placed close to the gain-setting resistors. Even with a low parasitic capacitance shunting the external resistors, excessively high resistor values can create significant time constants that can degrade performance. Good axial metal-film or surface-mount resistors have approximately 0.2 pF in shunt with the resistor. For resistor values greater than 2.0 k Ω , this parasitic capacitance can add a pole and/or a zero below 400 MHz that can affect circuit operation. Keep resistor values as low as possible, consistent with load driving considerations.
- Connections to other wideband devices on the board may be made with short direct traces or through onboard transmission lines. For short connections, consider the trace and the input to the next device as a lumped capacitive load. Relatively wide traces (50 mils to 100 mils, or 1.27 mm to 2.54 mm) should be used, preferably with ground and power planes opened up around them. Estimate the total capacitive load and determine if isolation resistors on the outputs are necessary. Low parasitic capacitive loads (less than 4 pF) may not need an R_S since the THS4500 family is nominally compensated to operate with a 2-pF parasitic load. Higher parasitic capacitive loads without an R_S are allowed as the signal gain increases (increasing the unloaded phase margin). If a long trace is required, and the 6-dB signal loss intrinsic to a doubly-terminated transmission line is acceptable, implement a matched impedance transmission line using microstrip or stripline techniques (consult an ECL design handbook for microstrip and stripline layout techniques).
- A 50- Ω environment is normally not necessary onboard, and in fact, a higher impedance environment improves distortion as shown in the distortion versus load plots. With a characteristic board trace impedance defined based onboard material and trace dimensions, a matching series resistor into the trace from the output of the THS4500 family is used as well as a terminating shunt resistor at the input of the destination device.
- Remember also that the terminating impedance is the parallel combination of the shunt resistor and the input impedance of the destination device: this total effective impedance should be set to match the trace impedance. If the 6-dB attenuation of a doubly-terminated transmission line is unacceptable, a long trace can be series-terminated at the source end only. Treat the trace as a capacitive load in this case. This configuration does not preserve signal integrity as well as a doubly-terminated line. If the input impedance of the destination device is low, there is some signal attenuation due to the voltage divider formed by the series output into the terminating impedance.
- Socketing a high-speed part such as the THS4500 family is not recommended. The additional lead length and pin-to-pin capacitance introduced by the socket can create an extremely troublesome parasitic network that can make it almost impossible to achieve a smooth, stable frequency response. Best results are obtained by soldering

the THS4500 family parts directly onto the board.

PowerPAD DESIGN CONSIDERATIONS

The THS4500 family is available in a thermally-enhanced PowerPAD set of packages. These packages are constructed using a downset leadframe upon which the die is mounted [see Figure 112(a) and Figure 112(b)]. This arrangement results in the lead frame being exposed as a thermal pad on the underside of the package [see Figure 112(c)]. Because this thermal pad has direct thermal contact with the die, excellent thermal performance can be achieved by providing a good thermal path away from the thermal pad.

The PowerPAD package allows for both assembly and thermal management in one manufacturing operation. During the surface-mount solder operation (when the leads are being soldered), the thermal pad can also be soldered to a copper area underneath the package. Through the use of thermal paths within this copper area, heat can be conducted away from the package into either a ground plane or other heat dissipating device.

The PowerPAD package represents a breakthrough in combining the small area and ease of assembly of surface mount with the, heretofore, awkward mechanical methods of heatsinking.

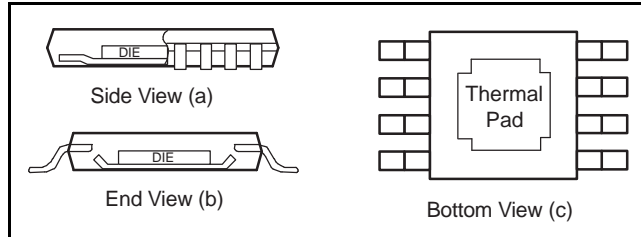

Figure 112. Views of PowerPAD, Thermally-Enhanced Package

Although there are many ways to properly heatsink the PowerPAD package, the following steps illustrate the recommended approach.

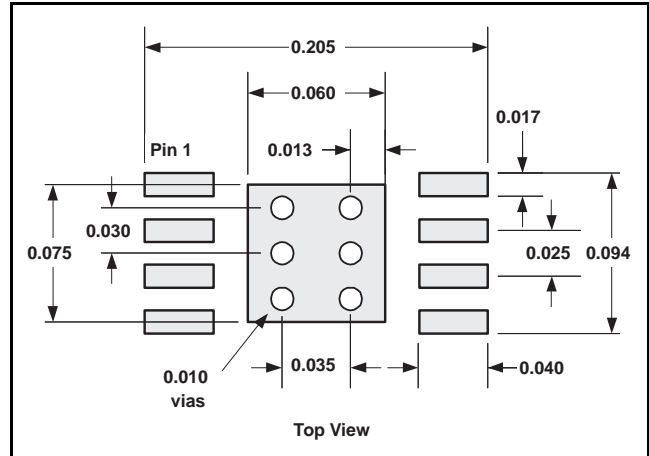

Figure 113. PowerPAD PCB Etch and Via Pattern

PowerPAD PCB LAYOUT CONSIDERATIONS

1. Prepare the PCB with a top side etch pattern as shown in Figure 113. There should be etch for the leads as well as etch for the thermal pad.
2. Place five holes in the area of the thermal pad. These holes should be 13 mils (0.33 mm) in diameter. Keep them small so that solder wicking through the holes is not a problem during reflow.
3. Additional vias may be placed anywhere along the thermal plane outside of the thermal pad area. These holes help dissipate the heat generated by the THS4500 family IC. These additional vias may be larger than the 13-mil diameter vias directly under the thermal pad. They can be larger because they are not in the thermal pad area to be soldered so that wicking is not a problem.
4. Connect all holes to the internal ground plane.
5. When connecting these holes to the ground plane, **do not** use the typical web or spoke via connection methodology. Web connections have a high thermal resistance connection that is useful for slowing the heat transfer during soldering operations. This transfer slowing makes the soldering of vias that have plane connections easier. In this application, however, low thermal resistance is desired for the most efficient heat transfer. Therefore, the holes under the THS4500 family PowerPAD package should make their connection to the internal ground plane with a complete connection around the entire circumference of the plated-through hole.

6. The top-side solder mask should leave the terminals of the package and the thermal pad area with its five holes exposed. The bottom-side solder mask should cover the five holes of the thermal pad area. This configuration prevents solder from being pulled away from the thermal pad area during the reflow process.
7. Apply solder paste to the exposed thermal pad area and all of the IC terminals.
8. With these preparatory steps in place, the IC is simply placed in position and run through the solder reflow operation as any standard surface-mount component. This process results in a part that is properly installed.

POWER DISSIPATION AND THERMAL CONSIDERATIONS

The THS4500 family of devices does not incorporate automatic thermal shutoff protection, so the designer must take care to ensure that the design does not violate the absolute maximum junction temperature of the device. Failure may result if the absolute maximum junction temperature of +150°C is exceeded. For best performance, design for a maximum junction temperature of +125°C. Between +125°C and +150°C, damage does not occur, but the performance of the amplifier begins to degrade.

The thermal characteristics of the device are dictated by the package and the PCB. Maximum power dissipation for a given package can be calculated using the following formula.

$$P_{Dmax} = \frac{T_{MAX} - T_A}{\theta_{JA}}$$

Where:

P_{Dmax} is the maximum power dissipation in the amplifier (W).

T_{MAX} is the absolute maximum junction temperature (°C).

T_A is the ambient temperature (°C).

$$\theta_{JA} = \theta_{JC} + \theta_{CA}$$

θ_{JC} is the thermal coefficient from the silicon junctions to the case (°C/W).

θ_{CA} is the thermal coefficient from the case to ambient air (°C/W). (28)

For systems where heat dissipation is more critical, the THS4500 family of devices is offered in an MSOP-8 package with PowerPAD. The thermal coefficient for the MSOP PowerPAD package is substantially improved over the traditional SOIC.

Maximum power dissipation levels are depicted in [Figure 114](#) for the two packages. The data for the DGN package assumes a board layout that follows the PowerPAD layout guidelines referenced above and detailed in the PowerPAD application notes in the *Additional Reference Material* section at the end of the data sheet.

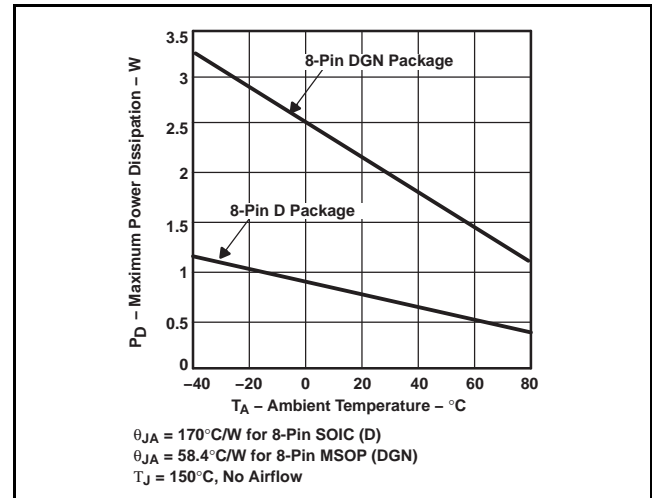

Figure 114. Maximum Power Dissipation vs Ambient Temperature

When determining whether or not the device satisfies the maximum power dissipation requirement, it is important to not only consider quiescent power dissipation, but also dynamic power dissipation. Often times, this consideration is difficult to quantify because the signal pattern is inconsistent; an estimate of the RMS power dissipation can provide visibility into a possible problem.

DRIVING CAPACITIVE LOADS

High-speed amplifiers are typically not well-suited for driving large capacitive loads. If necessary, however, the load capacitance should be isolated by two isolation resistors in series with the output. The requisite isolation resistor size depends on the value of the capacitance, but 10 Ω to 25 Ω is a good place to begin the optimization process. Larger isolation resistors decrease the amount of peaking in the frequency response induced by the capacitive load, but this decreased peaking comes at the expense of a larger voltage drop across the resistors, increasing the output swing requirements of the system.

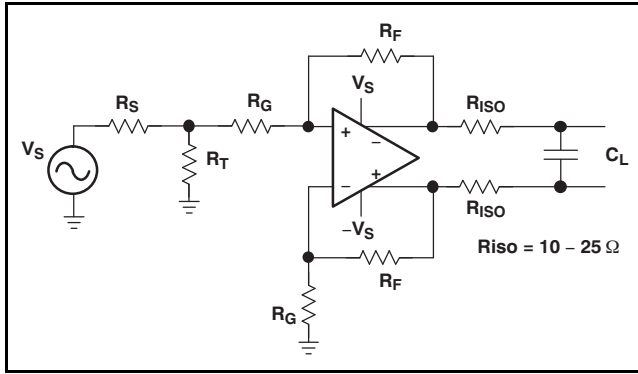

Figure 115. Use of Isolation Resistors With a Capacitive Load

POWER-SUPPLY DECOUPLING TECHNIQUES AND RECOMMENDATIONS

Power-supply decoupling is a critical aspect of any high-performance amplifier design process. Careful decoupling provides higher quality ac performance (most notably improved distortion performance). The following guidelines ensure the highest level of performance.

1. Place decoupling capacitors as close to the power-supply inputs as possible, with the goal of minimizing the inductance of the path from ground to the power supply.
2. Placement priority should be as follows: smaller capacitors should be closer to the device.
3. Use of solid power and ground planes is recommended to reduce the inductance along power-supply return current paths.
4. Recommended values for power-supply decoupling include 10- μ F and 0.1- μ F capacitors for each supply. A 1000-pF capacitor can be used across the supplies as well for extremely high frequency return currents, but often is not required.

EVALUATION FIXTURES, SPICE MODELS, AND APPLICATIONS SUPPORT

Texas Instruments is committed to providing its customers with the highest quality of applications support. To support this goal, an evaluation board has been developed for the THS4500 family of fully differential amplifiers. The evaluation board can be obtained by ordering through the [THS4500](#) or

[THS4501](#) product folder on the Texas Instruments web site, www.ti.com, or through your local Texas Instruments sales representative. A schematic for the evaluation board is shown in [Figure 116](#) with the default component values. Unpopulated footprints are shown to provide insight into design flexibility.

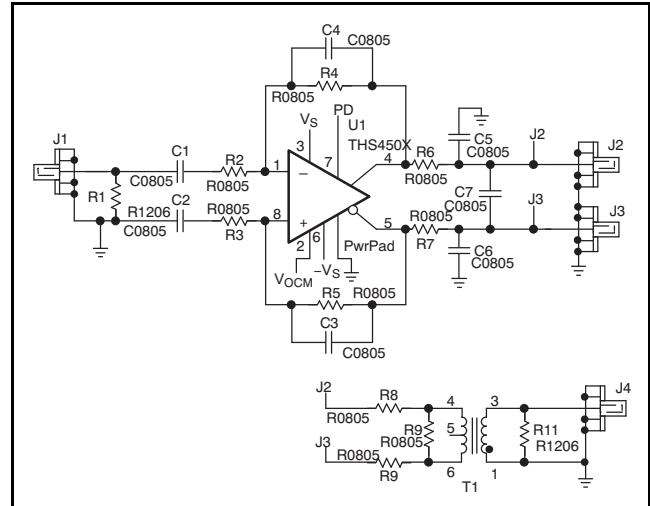

Figure 116. Simplified Schematic of the Evaluation Board

Computer simulation of circuit performance using SPICE is often useful when analyzing the performance of analog circuits and systems. This practice is particularly true for video and RF amplifier circuits where parasitic capacitance and inductance can have a major effect on circuit performance. A SPICE model for the THS4500 family of devices is available through either the Texas Instruments web site (www.ti.com) or as one model on a disk from the Texas Instruments Product Information Center (1-800-548-6132). The PIC is also available for design assistance and detailed product information at this number. These models do a good job of predicting small-signal ac and transient performance under a wide variety of operating conditions. They are not intended to model the distortion characteristics of the amplifier, nor do they attempt to distinguish between the package types in their small-signal ac performance. Detailed information about what is and is not modeled is contained in the model file itself.

ADDITIONAL REFERENCE MATERIAL

- *PowerPAD Made Easy*, application brief, Texas Instruments Literature Number [SLMA004](#).
- *PowerPAD Thermally-Enhanced Package*, technical brief, Texas Instruments Literature Number [SLMA002](#).
- Karki, James. *Fully Differential Amplifiers*. application report, Texas Instruments Literature Number [SLOA054D](#).
- Karki, James. *Fully Differential Amplifiers Applications: Line Termination, Driving High-Speed ADCs, and Differential Transmission Lines*. Texas Instruments Analog Applications Journal, February 2001.
- Carter, Bruce. *A Differential Op-Amp Circuit Collection*. application report, Texas Instruments Literature Number [SLOA064](#).
- Carter, Bruce. *Differential Op-Amp Single-Supply Design Technique*, application report, Texas Instruments Literature Number [SLOA072](#).
- Karki, James. *Designing for Low Distortion with High-Speed Op Amps*. Texas Instruments Analog Applications Journal, July 2001.

REVISION HISTORY

| Changes from Revision D (January 2004) to Revision E | Page |
|--|-------------|
| • Updated document format | 1 |
| • Added footnote 1 to Package/Ordering Information table | 3 |
| • Changed x-axis of Figure 27 | 12 |
| • Updated crossreferences for Figure 97 in first two paragraphs of the Fully Differential Amplifier Terminal Functions section | 22 |
| • Added <i>available for download at www.ti.com</i> and end of second paragraph of the Fully Differential Amplifier Terminal Functions section | 22 |
| • Changed <i>allow for calculation of</i> to <i>are used to calculate</i> in second paragraph of Input Common-Mode Voltage Range and the THS4500 Family section | 22 |
| • Clarified last sentence of third paragraph of Input Common-Mode Voltage Range and the THS4500 Family section | 22 |
| • Changed <i>two</i> to <i>four</i> in first sentence of Input Common-Mode Voltage Range and the THS4500 Family section | 22 |
| • Corrected title of Basic Design Considerations section | 24 |
| • Clarified cross-references of the circuits mentioned in the first sentence of the Basic Design Considerations section | 24 |
| • Deleted figure from Basic Design Considerations section | 24 |
| • Corrected cross-references in first sentence of Basic Design Considerations section | 24 |
| • Clarified the Interfacing to an Analog-to-Digital Converter section | 25 |
| • Removed cross-reference to nonexistent table in second paragraph of Setting the Output Common-Mode Voltage with the V_{OCM} Input section | 27 |
| • Added caption titles to figures in the Linearity: Definitions, Terminology, Circuit Techniques, and Design Tradeoffs section | 28 |
| • Changed <i>THS4502</i> to <i>THS4500</i> in seventh paragraph of Linearity: Definitions, Terminology, Circuit Techniques, and Design Tradeoffs section | 28 |
| • Corrected spelling in title of An Analysis of Noise in Fully Differential Amplifiers section | 29 |
| • Added <i>6.35 mm</i> to second bullet of Printed Circuit Board Layout Techniques for Optimal Performance list | 31 |
| • Added <i>1.27 mm to 2.54 mm</i> to fourth bullet of Printed Circuit Board Layout Techniques for Optimal Performance list | 31 |
| • Added <i>0.33 mm</i> to second list item in the PowerPAD PCB Layout Considerations section | 32 |
| • Changed title of Figure 116 | 34 |

| Changes from Revision E (MAy 2008) to Revision F | Page |
|---|-------------|
| • Added Figure 101 to the Basic Design Considerations section | 24 |

PACKAGING INFORMATION

| Orderable Device | Status (1) | Package Type | Package Drawing | Pins | Package Qty | Eco Plan (2) | Lead finish/ Ball material (6) | MSL Peak Temp (3) | Op Temp (°C) | Device Marking (4/5) | Samples |
|------------------|---------------|--------------|-----------------|------|-------------|-----------------|--------------------------------------|----------------------|--------------|-------------------------|-------------------------|
| THS4500CD | ACTIVE | SOIC | D | 8 | 75 | RoHS & Green | NIPDAU | Level-1-260C-UNLIM | 0 to 70 | 4500C | Samples |
| THS4500CDGNR | ACTIVE | HVSSOP | DGN | 8 | 2500 | RoHS & Green | NIPDAU | Level-1-260C-UNLIM | 0 to 70 | BFB | Samples |
| THS4500ID | ACTIVE | SOIC | D | 8 | 75 | RoHS & Green | NIPDAU | Level-1-260C-UNLIM | -40 to 85 | 4500I | Samples |
| THS4500IDGK | ACTIVE | VSSOP | DGK | 8 | 80 | RoHS & Green | NIPDAU | Level-1-260C-UNLIM | -40 to 85 | ASV | Samples |
| THS4500IDGN | ACTIVE | HVSSOP | DGN | 8 | 80 | RoHS & Green | NIPDAU | Level-1-260C-UNLIM | -40 to 85 | BFC | Samples |
| THS4500IDGNG4 | ACTIVE | HVSSOP | DGN | 8 | 80 | TBD | Call TI | Call TI | -40 to 85 | | Samples |
| THS4500IDGNR | ACTIVE | HVSSOP | DGN | 8 | 2500 | RoHS & Green | NIPDAU | Level-1-260C-UNLIM | -40 to 85 | BFC | Samples |
| THS4501CD | ACTIVE | SOIC | D | 8 | 75 | RoHS & Green | NIPDAU | Level-1-260C-UNLIM | 0 to 70 | 4501C | Samples |
| THS4501CDGN | ACTIVE | HVSSOP | DGN | 8 | 80 | RoHS & Green | NIPDAU | Level-1-260C-UNLIM | 0 to 70 | BFD | Samples |
| THS4501ID | ACTIVE | SOIC | D | 8 | 75 | RoHS & Green | NIPDAU | Level-1-260C-UNLIM | -40 to 85 | 4501I | Samples |
| THS4501IDGK | ACTIVE | VSSOP | DGK | 8 | 80 | RoHS & Green | NIPDAU | Level-1-260C-UNLIM | -40 to 85 | ASW | Samples |
| THS4501IDGN | ACTIVE | HVSSOP | DGN | 8 | 80 | RoHS & Green | NIPDAU | Level-1-260C-UNLIM | -40 to 85 | BFE | Samples |
| THS4501IDR | ACTIVE | SOIC | D | 8 | 2500 | RoHS & Green | NIPDAU | Level-1-260C-UNLIM | -40 to 85 | 4501I | Samples |

(1) The marketing status values are defined as follows:

ACTIVE: Product device recommended for new designs.

LIFEBUY: TI has announced that the device will be discontinued, and a lifetime-buy period is in effect.

NRND: Not recommended for new designs. Device is in production to support existing customers, but TI does not recommend using this part in a new design.

PREVIEW: Device has been announced but is not in production. Samples may or may not be available.

OBSELETE: TI has discontinued the production of the device.

(2) **RoHS:** TI defines "RoHS" to mean semiconductor products that are compliant with the current EU RoHS requirements for all 10 RoHS substances, including the requirement that RoHS substance do not exceed 0.1% by weight in homogeneous materials. Where designed to be soldered at high temperatures, "RoHS" products are suitable for use in specified lead-free processes. TI may reference these types of products as "Pb-Free".

RoHS Exempt: TI defines "RoHS Exempt" to mean products that contain lead but are compliant with EU RoHS pursuant to a specific EU RoHS exemption.

Green: TI defines "Green" to mean the content of Chlorine (Cl) and Bromine (Br) based flame retardants meet JS709B low halogen requirements of <=1000ppm threshold. Antimony trioxide based flame retardants must also meet the <=1000ppm threshold requirement.

(3) MSL, Peak Temp. - The Moisture Sensitivity Level rating according to the JEDEC industry standard classifications, and peak solder temperature.

(4) There may be additional marking, which relates to the logo, the lot trace code information, or the environmental category on the device.

(5) Multiple Device Markings will be inside parentheses. Only one Device Marking contained in parentheses and separated by a "~" will appear on a device. If a line is indented then it is a continuation of the previous line and the two combined represent the entire Device Marking for that device.

(6) Lead finish/Ball material - Orderable Devices may have multiple material finish options. Finish options are separated by a vertical ruled line. Lead finish/Ball material values may wrap to two lines if the finish value exceeds the maximum column width.

Important Information and Disclaimer:The information provided on this page represents TI's knowledge and belief as of the date that it is provided. TI bases its knowledge and belief on information provided by third parties, and makes no representation or warranty as to the accuracy of such information. Efforts are underway to better integrate information from third parties. TI has taken and continues to take reasonable steps to provide representative and accurate information but may not have conducted destructive testing or chemical analysis on incoming materials and chemicals. TI and TI suppliers consider certain information to be proprietary, and thus CAS numbers and other limited information may not be available for release.

In no event shall TI's liability arising out of such information exceed the total purchase price of the TI part(s) at issue in this document sold by TI to Customer on an annual basis.

OTHER QUALIFIED VERSIONS OF THS4500 :

- Enhanced Product : [THS4500-EP](#)

NOTE: Qualified Version Definitions:

- Enhanced Product - Supports Defense, Aerospace and Medical Applications

TAPE AND REEL INFORMATION

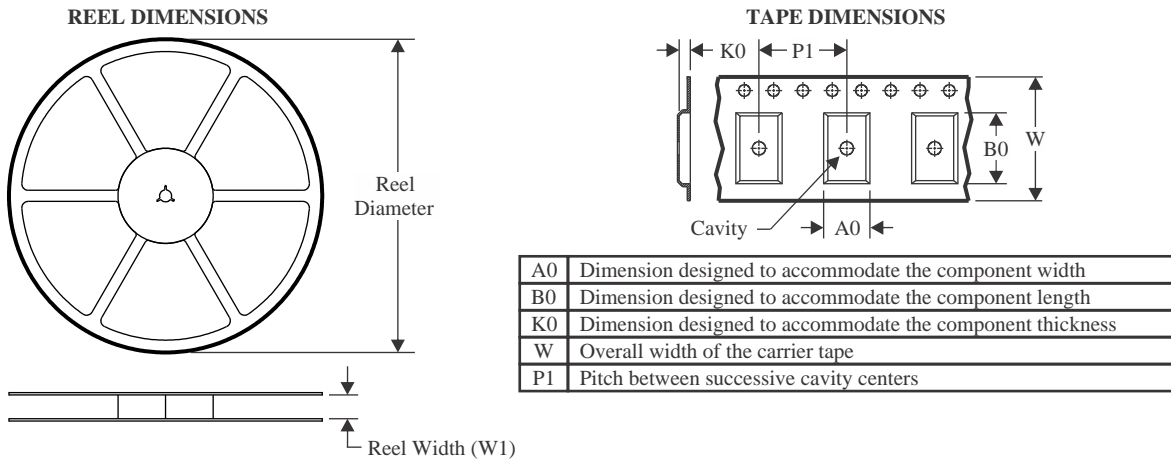

QUADRANT ASSIGNMENTS FOR PIN 1 ORIENTATION IN TAPE

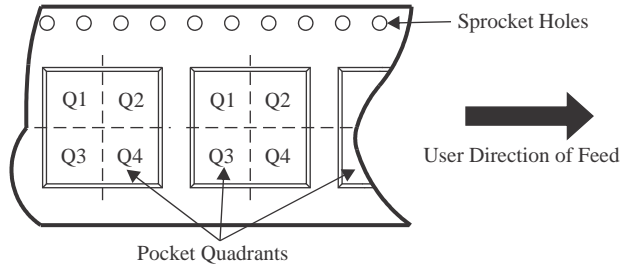

*All dimensions are nominal

| Device | Package Type | Package Drawing | Pins | SPQ | Reel Diameter (mm) | Reel Width W1 (mm) | A0 (mm) | B0 (mm) | K0 (mm) | P1 (mm) | W (mm) | Pin1 Quadrant |
|--------------|--------------|-----------------|------|------|--------------------|--------------------|---------|---------|---------|---------|--------|---------------|
| THS4500CDGNR | HVSSOP | DGN | 8 | 2500 | 330.0 | 12.4 | 5.3 | 3.4 | 1.4 | 8.0 | 12.0 | Q1 |
| THS4500IDGNR | HVSSOP | DGN | 8 | 2500 | 330.0 | 12.4 | 5.3 | 3.4 | 1.4 | 8.0 | 12.0 | Q1 |
| THS4501IDR | SOIC | D | 8 | 2500 | 330.0 | 12.4 | 6.4 | 5.2 | 2.1 | 8.0 | 12.0 | Q1 |

TAPE AND REEL BOX DIMENSIONS



*All dimensions are nominal

| Device | Package Type | Package Drawing | Pins | SPQ | Length (mm) | Width (mm) | Height (mm) |
|--------------|--------------|-----------------|------|------|-------------|------------|-------------|
| THS4500CDGNR | HVSSOP | DGN | 8 | 2500 | 358.0 | 335.0 | 35.0 |
| THS4500IDGNR | HVSSOP | DGN | 8 | 2500 | 358.0 | 335.0 | 35.0 |
| THS4501IDR | SOIC | D | 8 | 2500 | 350.0 | 350.0 | 43.0 |

TUBE

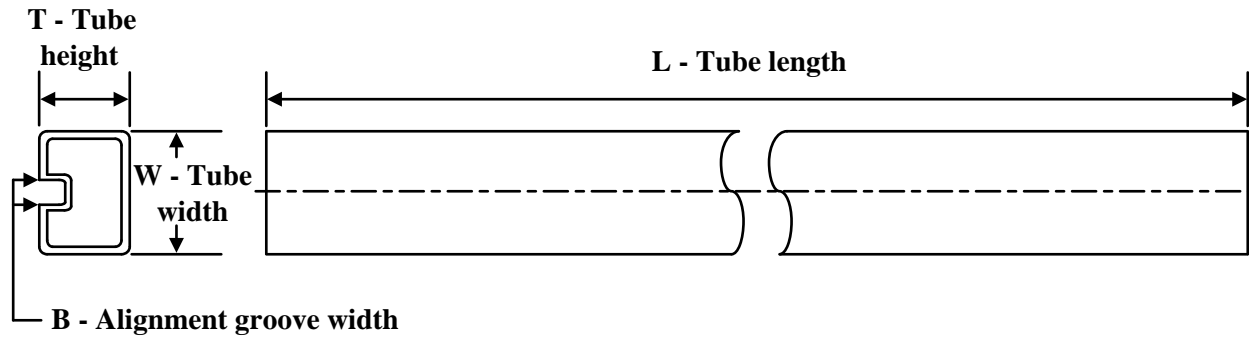

*All dimensions are nominal

| Device | Package Name | Package Type | Pins | SPQ | L (mm) | W (mm) | T (μm) | B (mm) |
|-----------|--------------|--------------|------|-----|--------|--------|--------|--------|
| THS4500CD | D | SOIC | 8 | 75 | 505.46 | 6.76 | 3810 | 4 |
| THS4500ID | D | SOIC | 8 | 75 | 505.46 | 6.76 | 3810 | 4 |
| THS4501CD | D | SOIC | 8 | 75 | 505.46 | 6.76 | 3810 | 4 |
| THS4501ID | D | SOIC | 8 | 75 | 505.46 | 6.76 | 3810 | 4 |



D0008A

PACKAGE OUTLINE

SOIC - 1.75 mm max height

SMALL OUTLINE INTEGRATED CIRCUIT

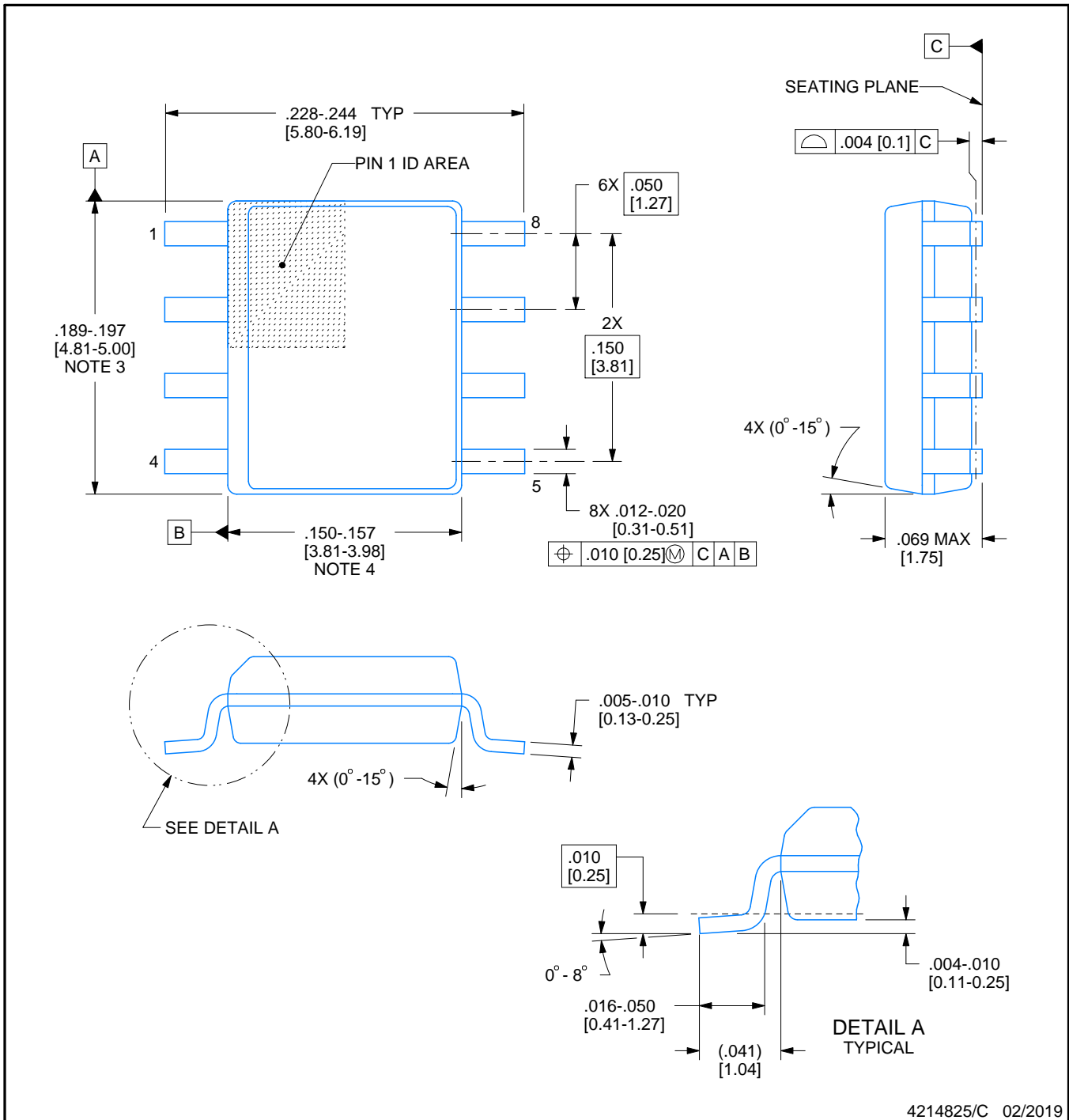

4214825/C 02/2019

NOTES:

1. Linear dimensions are in inches [millimeters]. Dimensions in parenthesis are for reference only. Controlling dimensions are in inches. Dimensioning and tolerancing per ASME Y14.5M.
2. This drawing is subject to change without notice.
3. This dimension does not include mold flash, protrusions, or gate burrs. Mold flash, protrusions, or gate burrs shall not exceed $.006$ [0.15] per side.
4. This dimension does not include interlead flash.
5. Reference JEDEC registration MS-012, variation AA.

EXAMPLE BOARD LAYOUT

D0008A

SOIC - 1.75 mm max height

SMALL OUTLINE INTEGRATED CIRCUIT

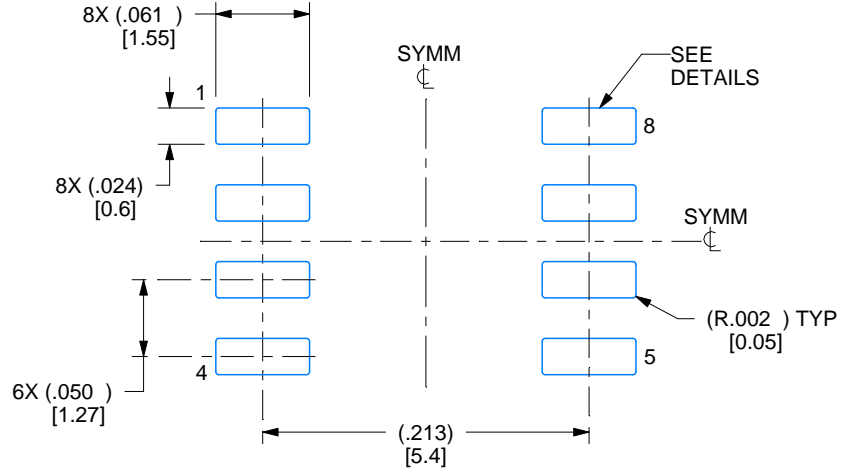

LAND PATTERN EXAMPLE
 EXPOSED METAL SHOWN
 SCALE:8X

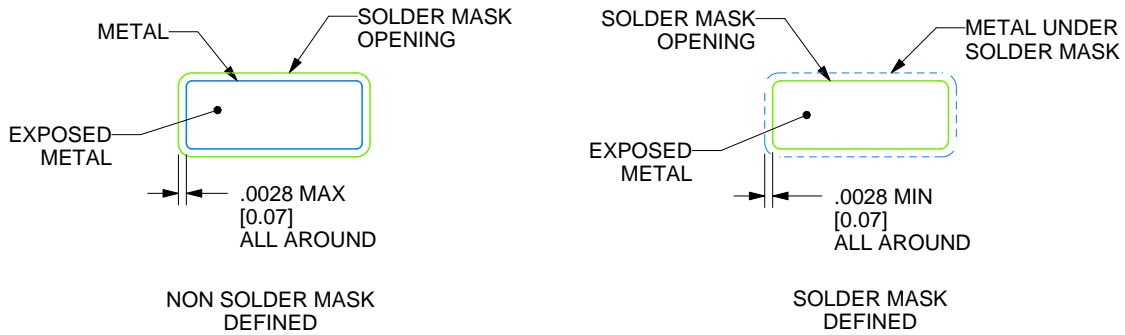

SOLDER MASK DETAILS

4214825/C 02/2019

NOTES: (continued)

- 6. Publication IPC-7351 may have alternate designs.
- 7. Solder mask tolerances between and around signal pads can vary based on board fabrication site.

EXAMPLE STENCIL DESIGN

D0008A

SOIC - 1.75 mm max height

SMALL OUTLINE INTEGRATED CIRCUIT

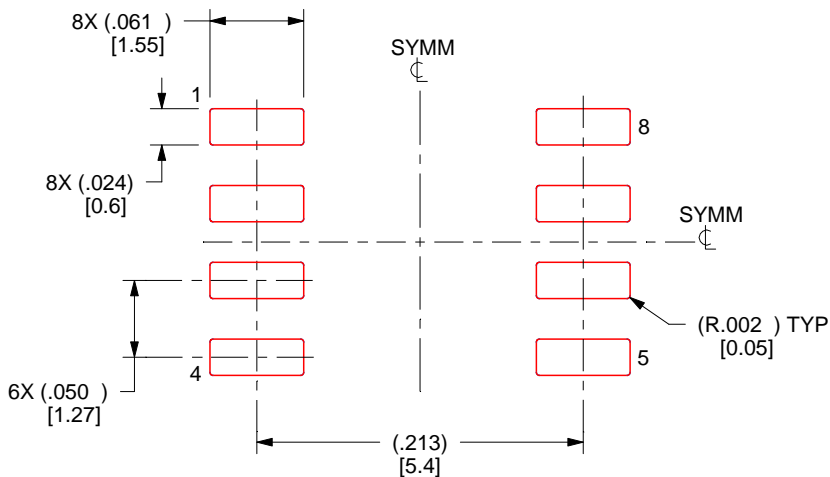

SOLDER PASTE EXAMPLE
 BASED ON .005 INCH [0.125 MM] THICK STENCIL
 SCALE:8X

4214825/C 02/2019

NOTES: (continued)

- 8. Laser cutting apertures with trapezoidal walls and rounded corners may offer better paste release. IPC-7525 may have alternate design recommendations.
- 9. Board assembly site may have different recommendations for stencil design.

GENERIC PACKAGE VIEW**DGN 8****PowerPAD™ HVSSOP - 1.1 mm max height****3 x 3, 0.65 mm pitch**

SMALL OUTLINE PACKAGE

This image is a representation of the package family, actual package may vary.
Refer to the product data sheet for package details.

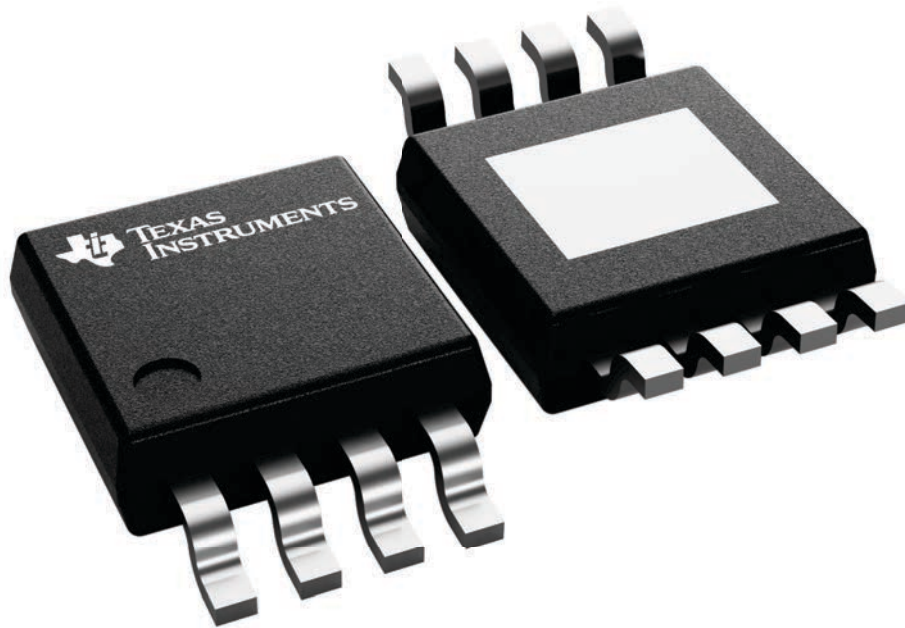

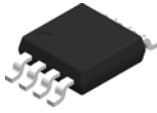

PACKAGE OUTLINE

DGN0008D

PowerPAD™ VSSOP - 1.1 mm max height

SMALL OUTLINE PACKAGE

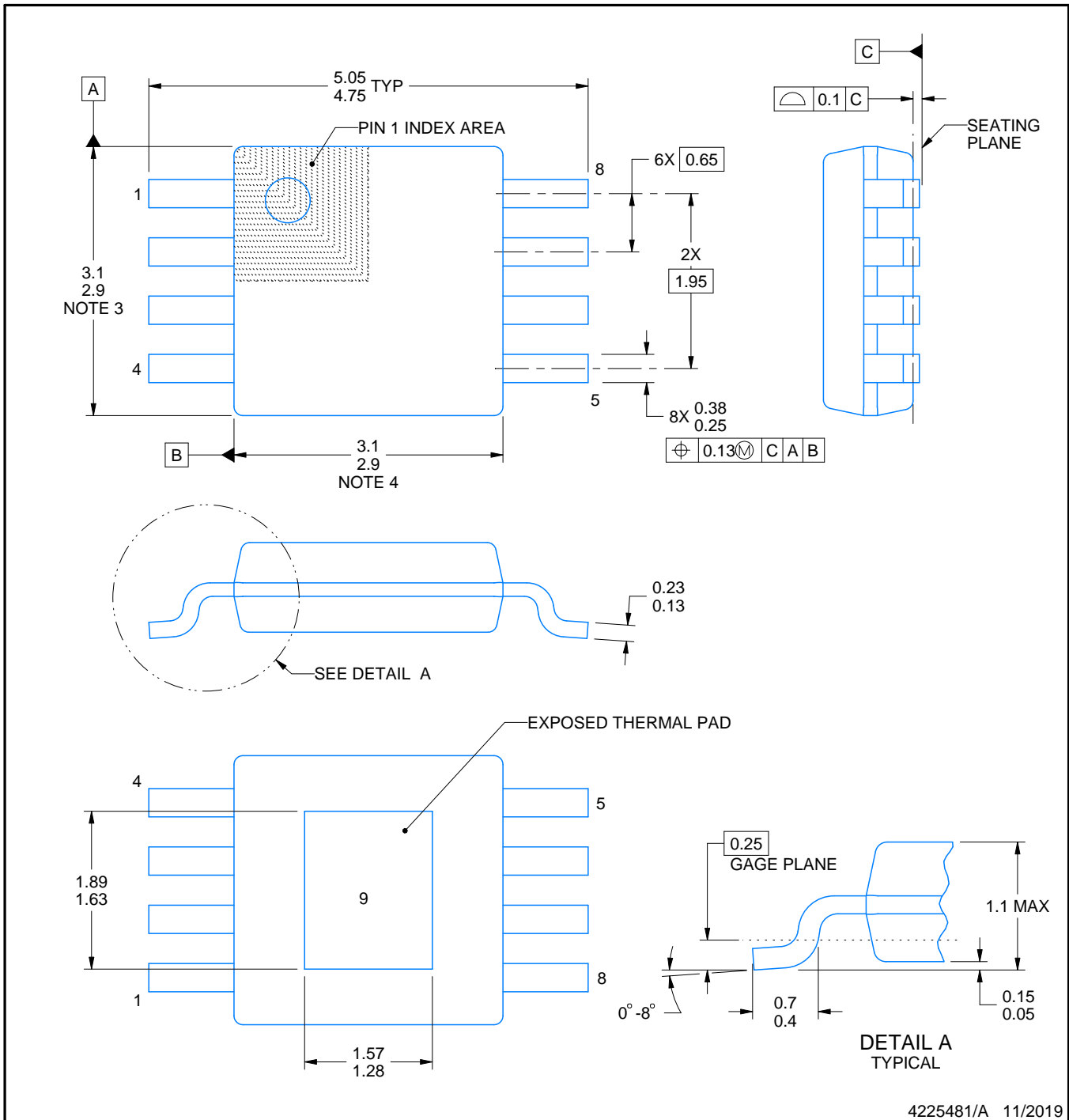

4225481/A 11/2019

NOTES:

PowerPAD is a trademark of Texas Instruments.

1. All linear dimensions are in millimeters. Any dimensions in parenthesis are for reference only. Dimensioning and tolerancing per ASME Y14.5M.
2. This drawing is subject to change without notice.
3. This dimension does not include mold flash, protrusions, or gate burrs. Mold flash, protrusions, or gate burrs shall not exceed 0.15 mm per side.
4. This dimension does not include interlead flash. Interlead flash shall not exceed 0.25 mm per side.
5. Reference JEDEC registration MO-187.

EXAMPLE BOARD LAYOUT

DGN0008D

PowerPAD™ VSSOP - 1.1 mm max height

SMALL OUTLINE PACKAGE

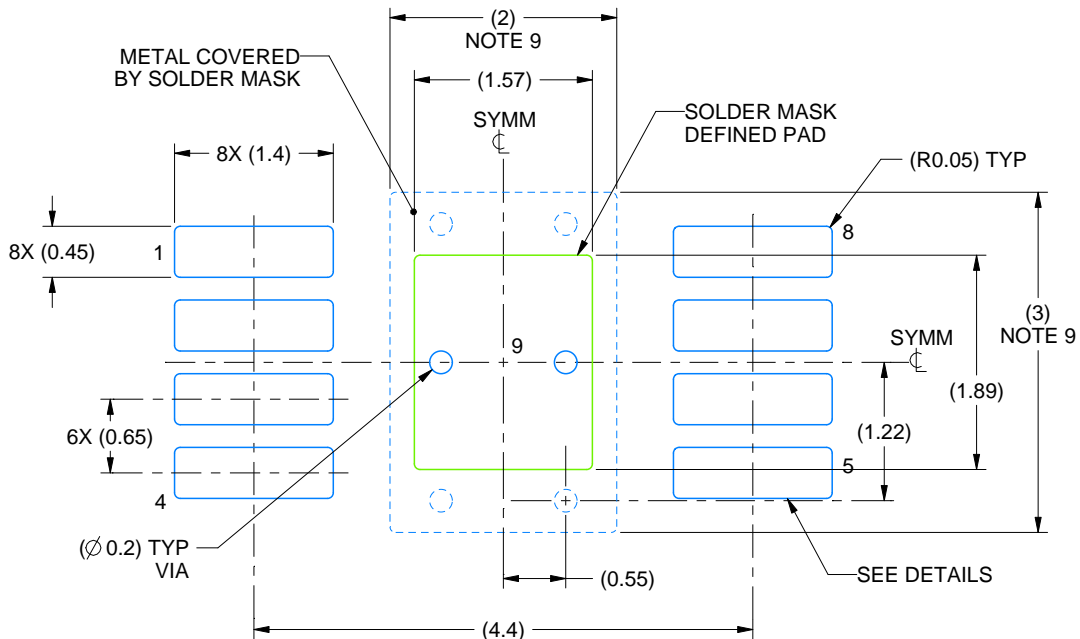

LAND PATTERN EXAMPLE
EXPOSED METAL SHOWN
SCALE: 15X

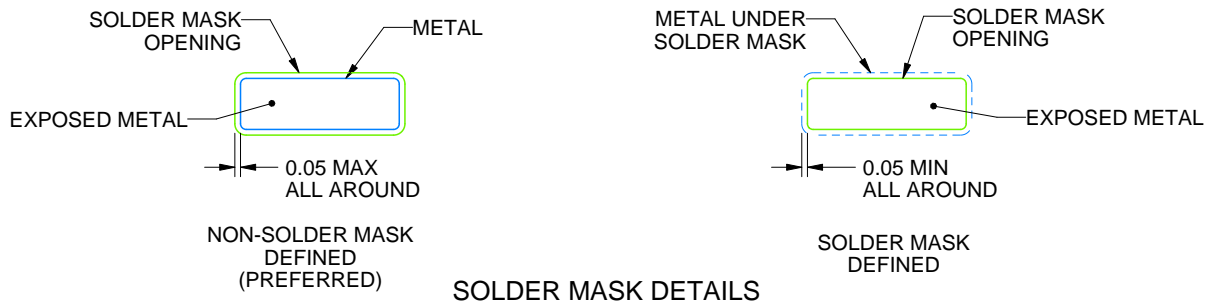

SOLDER MASK DETAILS

4225481/A 11/2019

NOTES: (continued)

6. Publication IPC-7351 may have alternate designs.
7. Solder mask tolerances between and around signal pads can vary based on board fabrication site.
8. Vias are optional depending on application, refer to device data sheet. If any vias are implemented, refer to their locations shown on this view. It is recommended that vias under paste be filled, plugged or tented.
9. Size of metal pad may vary due to creepage requirement.

EXAMPLE STENCIL DESIGN

DGN0008D

PowerPAD™ VSSOP - 1.1 mm max height

SMALL OUTLINE PACKAGE

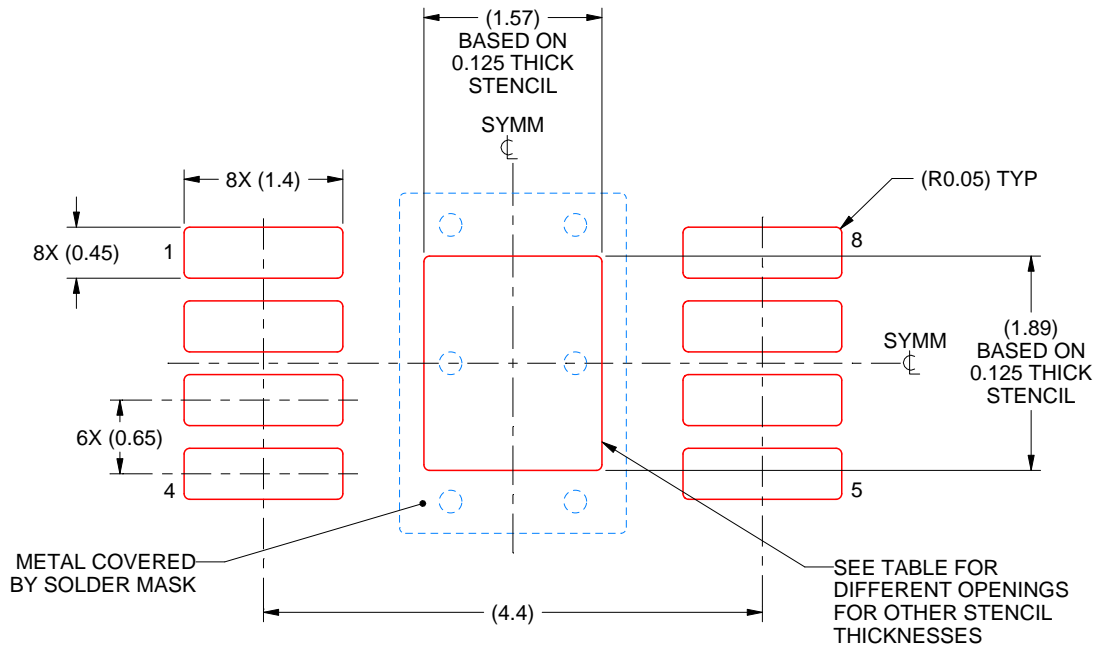

SOLDER PASTE EXAMPLE
 EXPOSED PAD 9:
 100% PRINTED SOLDER COVERAGE BY AREA
 SCALE: 15X

| STENCIL THICKNESS | SOLDER STENCIL OPENING |
|-------------------|------------------------|
| 0.1 | 1.76 X 2.11 |
| 0.125 | 1.57 X 1.89 (SHOWN) |
| 0.15 | 1.43 X 1.73 |
| 0.175 | 1.33 X 1.60 |

4225481/A 11/2019

NOTES: (continued)

- 10. Laser cutting apertures with trapezoidal walls and rounded corners may offer better paste release. IPC-7525 may have alternate design recommendations.
- 11. Board assembly site may have different recommendations for stencil design.



DGK0008A

PACKAGE OUTLINE

VSSOP - 1.1 mm max height

SMALL OUTLINE PACKAGE

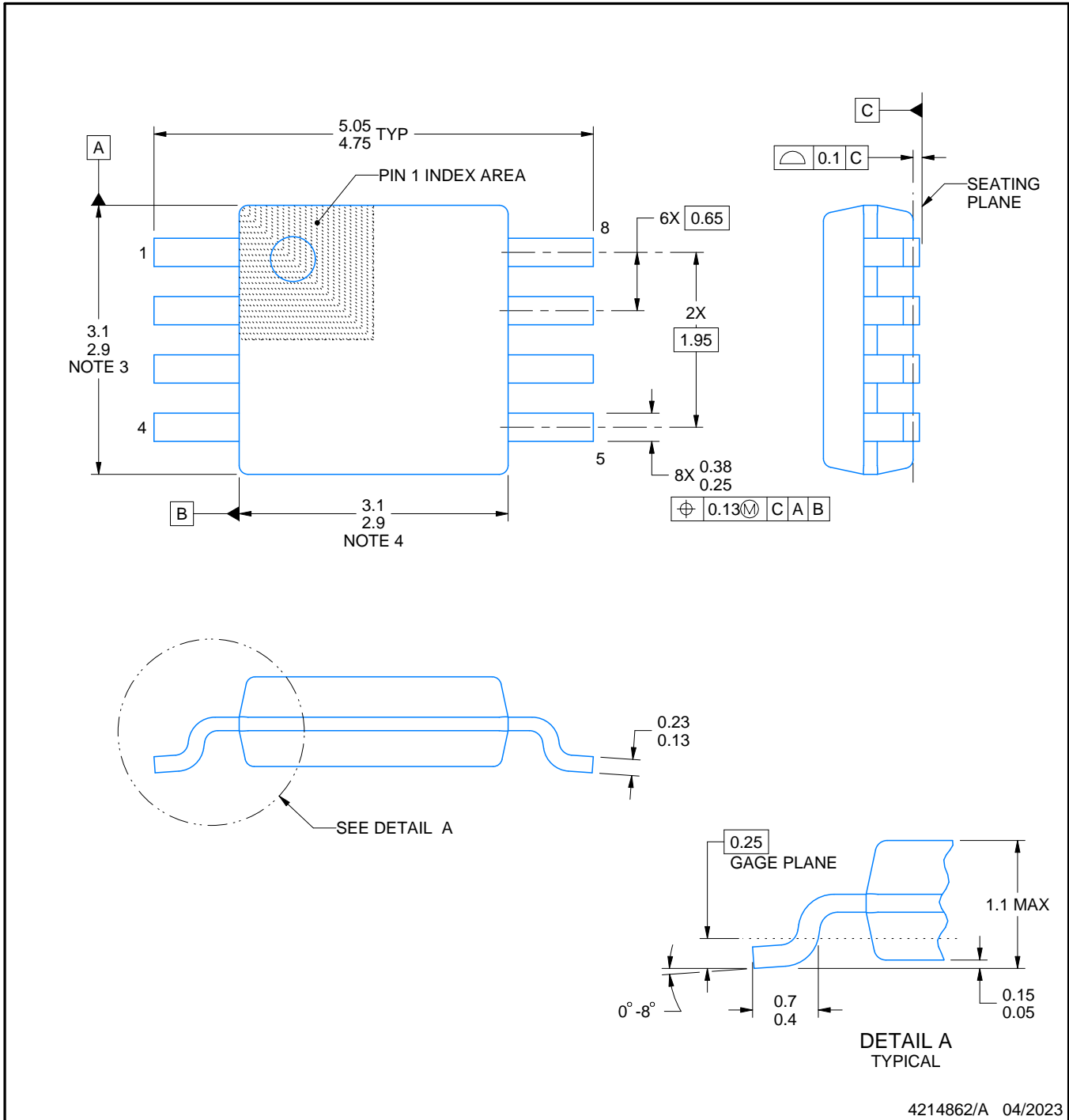

NOTES:

PowerPAD is a trademark of Texas Instruments.

1. All linear dimensions are in millimeters. Any dimensions in parenthesis are for reference only. Dimensioning and tolerancing per ASME Y14.5M.
2. This drawing is subject to change without notice.
3. This dimension does not include mold flash, protrusions, or gate burrs. Mold flash, protrusions, or gate burrs shall not exceed 0.15 mm per side.
4. This dimension does not include interlead flash. Interlead flash shall not exceed 0.25 mm per side.
5. Reference JEDEC registration MO-187.

EXAMPLE BOARD LAYOUT

DGK0008A

TM VSSOP - 1.1 mm max height

SMALL OUTLINE PACKAGE

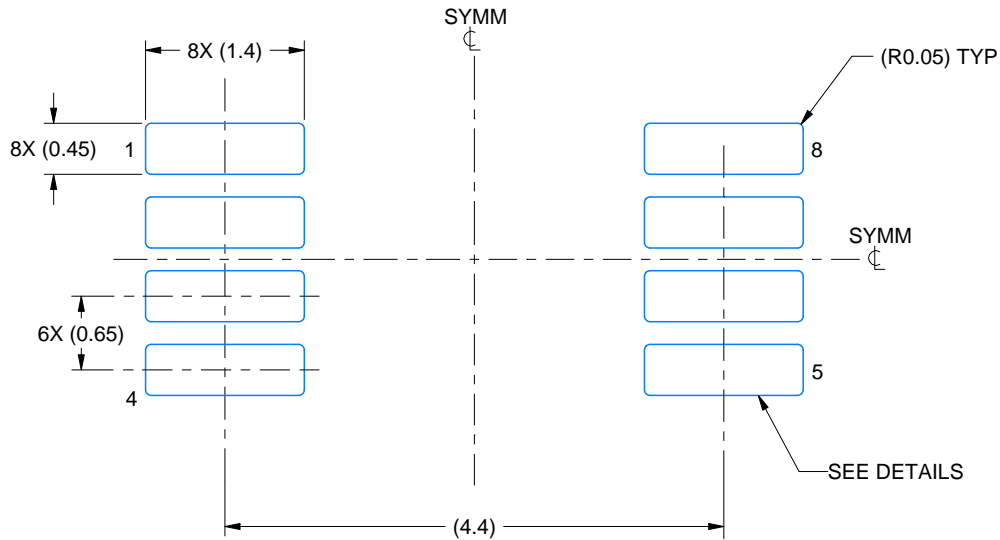

LAND PATTERN EXAMPLE
EXPOSED METAL SHOWN
SCALE: 15X

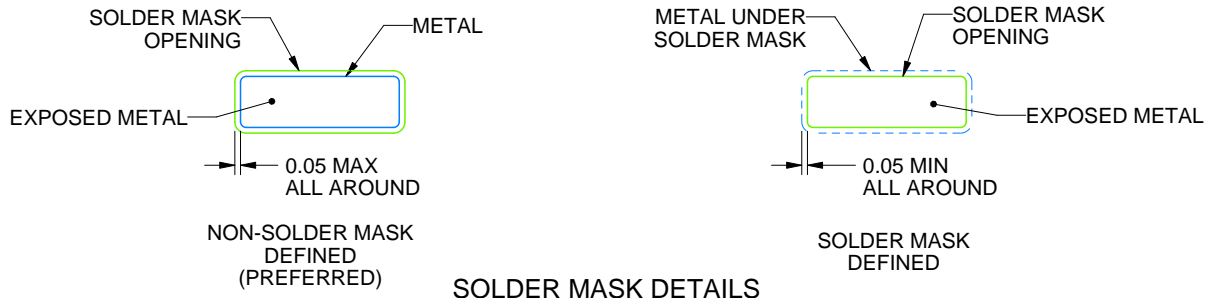

SOLDER MASK DETAILS

4214862/A 04/2023

NOTES: (continued)

- 6. Publication IPC-7351 may have alternate designs.
- 7. Solder mask tolerances between and around signal pads can vary based on board fabrication site.
- 8. Vias are optional depending on application, refer to device data sheet. If any vias are implemented, refer to their locations shown on this view. It is recommended that vias under paste be filled, plugged or tented.
- 9. Size of metal pad may vary due to creepage requirement.

EXAMPLE STENCIL DESIGN

DGK0008A

TM VSSOP - 1.1 mm max height

SMALL OUTLINE PACKAGE

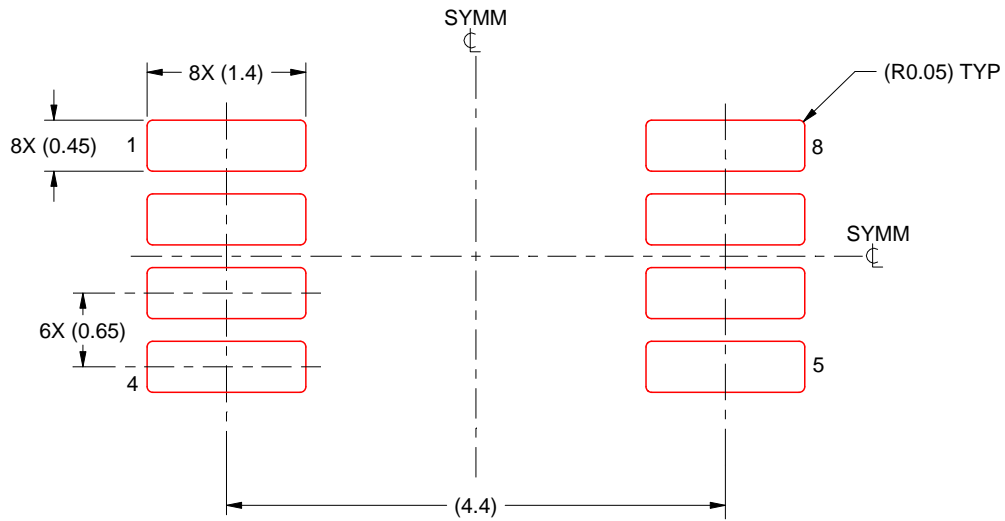

SOLDER PASTE EXAMPLE
SCALE: 15X

4214862/A 04/2023

NOTES: (continued)

11. Laser cutting apertures with trapezoidal walls and rounded corners may offer better paste release. IPC-7525 may have alternate design recommendations.
12. Board assembly site may have different recommendations for stencil design.

IMPORTANT NOTICE AND DISCLAIMER

TI PROVIDES TECHNICAL AND RELIABILITY DATA (INCLUDING DATA SHEETS), DESIGN RESOURCES (INCLUDING REFERENCE DESIGNS), APPLICATION OR OTHER DESIGN ADVICE, WEB TOOLS, SAFETY INFORMATION, AND OTHER RESOURCES "AS IS" AND WITH ALL FAULTS, AND DISCLAIMS ALL WARRANTIES, EXPRESS AND IMPLIED, INCLUDING WITHOUT LIMITATION ANY IMPLIED WARRANTIES OF MERCHANTABILITY, FITNESS FOR A PARTICULAR PURPOSE OR NON-INFRINGEMENT OF THIRD PARTY INTELLECTUAL PROPERTY RIGHTS.

These resources are intended for skilled developers designing with TI products. You are solely responsible for (1) selecting the appropriate TI products for your application, (2) designing, validating and testing your application, and (3) ensuring your application meets applicable standards, and any other safety, security, regulatory or other requirements.

These resources are subject to change without notice. TI grants you permission to use these resources only for development of an application that uses the TI products described in the resource. Other reproduction and display of these resources is prohibited. No license is granted to any other TI intellectual property right or to any third party intellectual property right. TI disclaims responsibility for, and you will fully indemnify TI and its representatives against, any claims, damages, costs, losses, and liabilities arising out of your use of these resources.

TI's products are provided subject to [TI's Terms of Sale](#) or other applicable terms available either on [ti.com](https://www.ti.com) or provided in conjunction with such TI products. TI's provision of these resources does not expand or otherwise alter TI's applicable warranties or warranty disclaimers for TI products.

TI objects to and rejects any additional or different terms you may have proposed.

Mailing Address: Texas Instruments, Post Office Box 655303, Dallas, Texas 75265
Copyright © 2024, Texas Instruments Incorporated

OUR CERTIFICATE

DiGi provide top-quality products and perfect service for customer worldwide through standardization, technological innovation and continuous improvement. DiGi through third-party certification, we stricly control the quality of products and services. Welcome your RFQ to

Email: Info@DiGi-Electronics.com



Tel: +00 852-30501935

RFQ Email: Info@DiGi-Electronics.com

DiGi is a global authorized distributor of electronic components.