

# TL3016CPWR Datasheet

[www.digi-electronics.com](http://www.digi-electronics.com)

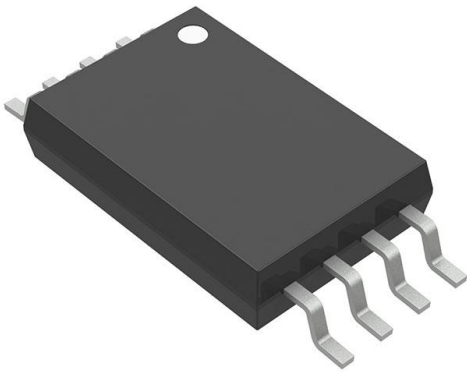

<https://www.DiGi-Electronics.com>

DiGi Electronics Part Number	TL3016CPWR-DG
Manufacturer	<a href="#">Texas Instruments</a>
Manufacturer Product Number	TL3016CPWR
Description	IC COMPARATOR 1 W/LATCH 8TSSOP
Detailed Description	Comparator with Latch Complementary, Push-Pull, TTL 8-TSSOP



Tel: +00 852-30501935

RFQ Email: [Info@DiGi-Electronics.com](mailto:Info@DiGi-Electronics.com)

DiGi is a global authorized distributor of electronic components.

## Purchase and inquiry

Manufacturer Product Number:

TL3016CPWR

Series:

-

Type:

with Latch

Output Type:

Complementary, Push-Pull, TTL

Voltage - Input Offset (Max):

3mV @ ±5V

Current - Output (Typ):

20mA

CMRR, PSRR (Typ):

97dB CMRR

Hysteresis:

-

Package / Case:

8-TSSOP (0.173", 4.40mm Width)

Supplier Device Package:

8-TSSOP

Manufacturer:

Texas Instruments

Product Status:

Active

Number of Elements:

1

Voltage - Supply, Single/Dual (±):

5V ~ 10V, ±2.5V ~ 5V

Current - Input Bias (Max):

10µA @ ±5V

Current - Quiescent (Max):

12.5mA

Propagation Delay (Max):

10ns

Operating Temperature:

0°C ~ 70°C

Mounting Type:

Surface Mount

Base Product Number:

TL3016

## Environmental & Export classification

RoHS Status:

ROHS3 Compliant

REACH Status:

REACH Unaffected

HTSUS:

8542.39.0001

Moisture Sensitivity Level (MSL):

1 (Unlimited)

ECCN:

EAR99



- Ultrafast Operation . . . 7.6 ns (Typ)
- Low Positive Supply Current  
10.6 mA (Typ)
- Operates From a Single 5-V Supply or From a Split  $\pm 5$ -V Supply
- Complementary Outputs
- Low Offset Voltage
- No Minimum Slew Rate Requirement
- Output Latch Capability
- Functional Replacement to the LT1016

D AND PW PACKAGE  
(TOP VIEW)

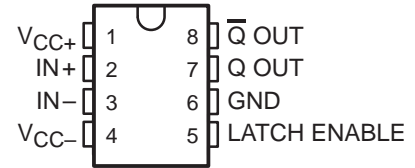

**description**

The TL3016 is an ultrafast comparator designed to interface directly to TTL logic while operating from either a single 5-V power supply or dual  $\pm 5$ -V supplies. It features extremely tight offset voltage and high gain for precision applications. It has complementary outputs that can be latched using the LATCH ENABLE terminal. Figure 1 shows the positive supply current of this comparator. The TL3016 only requires 10.6 mA (typical) to achieve a propagation delay of 7.6 ns.

The TL3016 is a pin-for-pin functional replacement for the LT1016 comparator, offering higher speed operation but consuming half the power.

symbol (each comparator)

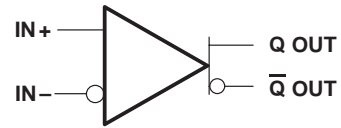

POSITIVE SUPPLY CURRENT  
vs  
FREE-AIR TEMPERATURE

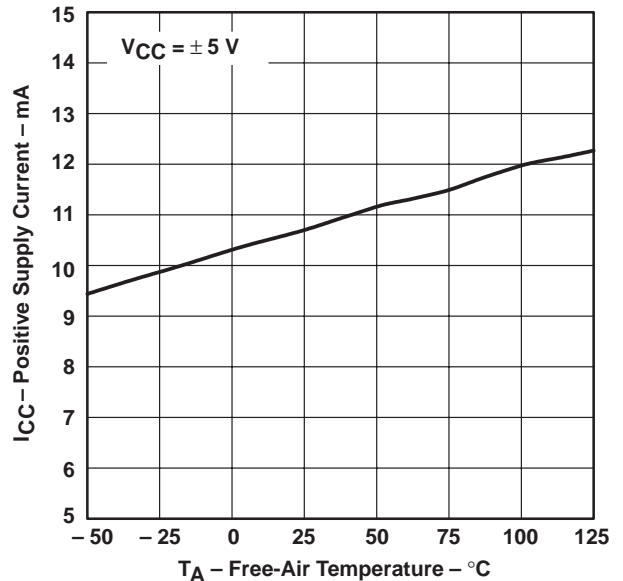

Figure 1

AVAILABLE OPTIONS

T <sub>A</sub>	PACKAGED DEVICES		CHIP FORM <sup>‡</sup> (Y)
	SMALL OUTLINE <sup>†</sup> (D)	TSSOP (PW)	
0°C to 70°C	TL3016CD	TL3016CPWLE	TL3016Y
-40°C to 85°C	TL3016ID	TL3016IPWLE	—

<sup>†</sup> The PW packages are available left-ended taped and reeled only.  
<sup>‡</sup> Chip forms are tested at T<sub>A</sub> = 25°C only.



Please be aware that an important notice concerning availability, standard warranty, and use in critical applications of Texas Instruments semiconductor products and disclaimers thereto appears at the end of this data sheet.

PRODUCTION DATA information is current as of publication date. Products conform to specifications per the terms of Texas Instruments standard warranty. Production processing does not necessarily include testing of all parameters.



# TL3016, TL3016Y ULTRA-FAST LOW-POWER PRECISION COMPARATORS

SLCS130D – MARCH 1997 – REVISED MARCH 2000

## TL3016Y chip information

This chip displays characteristics similar to the TL3016C. Thermal compression or ultrasonic bonding may be used on the doped-aluminum bonding pads. Chips may be mounted with conductive epoxy or a gold-silicon preform.

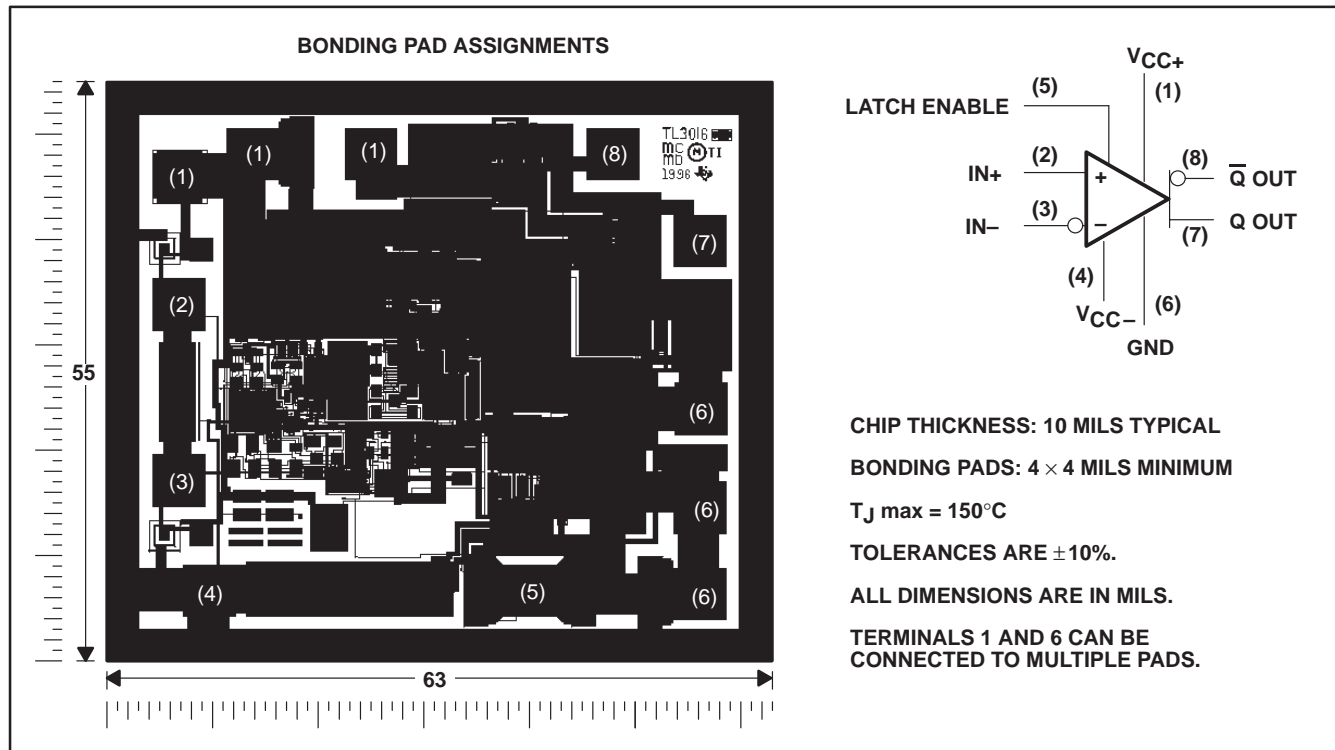

COMPONENT COUNT	
Bipolars	53
MOSFETs	49
Resistors	46
Capacitors	14

**absolute maximum ratings over operating free-air temperature range (unless otherwise noted)†**

Supply voltage, $V_{DD}$ (see Note 1)	– 7 V to 7 V
Differential input voltage, $V_{ID}$ (see Note 2)	7 V
Input voltage range, $V_I$	7 V
Input voltage, $V_I$ (LATCH ENABLE)	7 V
Output current, $I_O$	± 20 mA
Continuous total power dissipation	See Dissipation Rating Table
Operating free-air temperature range, $T_A$	–40°C to 85°C
Storage temperature range, $T_{stg}$	– 65°C to 150°C
Lead temperature 1,6 mm (1/16 inch) from case for 10 seconds	260°C

† Stresses beyond those listed under “absolute maximum ratings” may cause permanent damage to the device. These are stress ratings only, and functional operation of the device at these or any other conditions beyond those indicated under “recommended operating conditions” is not implied. Exposure to absolute-maximum-rated conditions for extended periods may affect device reliability.

- NOTES: 1. All voltage values, except differential voltages, are with respect to network ground.  
 2. Differential voltages are at IN+ with respect to IN–.

**DISSIPATION RATING TABLE**

<b>PACKAGE</b>	<b><math>T_A \leq 25^\circ\text{C}</math> POWER RATING</b>	<b>DERATING FACTOR ABOVE <math>T_A = 25^\circ\text{C}</math></b>	<b><math>T_A = 70^\circ\text{C}</math> POWER RATING</b>
D	725 mW	5.8 mW/°C	464 mW
PW	525 mW	4.2 mW/°C	336 mW



# TL3016, TL3016Y

## ULTRA-FAST LOW-POWER PRECISION COMPARATORS

SLCS130D – MARCH 1997 – REVISED MARCH 2000

electrical characteristics at specified operating free-air temperature,  $V_{DD} = \pm 5\text{ V}$ ,  $V_{LE} = 0$  (unless otherwise noted)

PARAMETER		TEST CONDITION <sup>†</sup>	TL3016C			TL3016I			UNIT
			MIN	TYP <sup>‡</sup>	MAX	MIN	TYP <sup>‡</sup>	MAX	
$V_{IO}$	Input offset voltage	$T_A = 25^\circ\text{C}$	0.5		3	0.5		3	mV
		$T_A = \text{full range}$	3.5			3.5			
$\alpha_{VIO}$	Temperature coefficient of input offset voltage		-4.8			-4.5		$\mu\text{V}/^\circ\text{C}$	
$I_{IO}$	Input offset current	$T_A = 25^\circ\text{C}$	0.1	0.6		0.1	0.6		$\mu\text{A}$
		$T_A = \text{full range}$	0.9			1.3			
$I_{IB}$	Input bias current	$T_A = 25^\circ\text{C}$	6		10	6		10	$\mu\text{A}$
		$T_A = \text{full range}$	10			10			
$V_{ICR}$	Common-mode input voltage range	$V_{DD} = \pm 5\text{ V}$	-3.75	3.5		-3.75	3.5		V
		$V_{DD} = 5\text{ V}$	1.25	3.5		1.25	3.5		
CMRR	Common-mode rejection ratio	$-3.75 \leq V_{IC} \leq 3.5\text{ V}$ , $T_A = 25^\circ\text{C}$	80	97		80	97		dB
$k_{SVR}$	Supply-voltage rejection ratio	Positive supply: $4.6\text{ V} \leq +V_{DD} \leq 5.4\text{ V}$ , $T_A = 25^\circ\text{C}$	60	72		60	72		dB
		Negative supply: $-7\text{ V} \leq -V_{DD} \leq -2\text{ V}$ , $T_A = 25^\circ\text{C}$	80	100		80	100		
$V_{OL}$	Low-level output voltage	$I_{(\text{sink})} = 4\text{ mA}$ , $V_+ \leq 4.6\text{ V}$ , $T_A = 25^\circ\text{C}$	500	600		500	600		mV
		$I_{(\text{sink})} = 10\text{ mA}$ , $V_+ \leq 4.6\text{ V}$ , $T_A = 25^\circ\text{C}$	750			750			
$V_{OH}$	High-level output voltage	$V_+ \leq 4.6\text{ V}$ , $T_A = 25^\circ\text{C}$ , $I_O = 1\text{ mA}$	3.6	3.9		3.6	3.9		V
		$V_+ \leq 4.6\text{ V}$ , $T_A = 25^\circ\text{C}$ , $I_O = 10\text{ mA}$	3.4	3.7		3.4	3.7		
$I_{DD}$	Positive supply current	$T_A = \text{full range}$	10.6		12.5	10.6		12.5	mA
	Negative supply current		-1.8	-1.3		-2.4	-1.3		
$V_{IL}$	Low-level input voltage (LATCH ENABLE)		0.8			0.8			V
$V_{IH}$	High-level input voltage (LATCH ENABLE)		2			2			V
$I_{IL}$	Low-level input current (LATCH ENABLE)	$V_{LE} = 0$	0		1	0		1	$\mu\text{A}$
		$V_{LE} = 2\text{ V}$	24	39		24	45		

<sup>†</sup> Full range for the TL3016C is  $T_A = 0^\circ\text{C}$  to  $70^\circ\text{C}$ . Full range for the TL3016I is  $T_A = -40^\circ\text{C}$  to  $85^\circ\text{C}$ .

<sup>‡</sup> All typical values are measures with  $T_A = 25^\circ\text{C}$ .



**switching characteristics,  $V_{DD} = \pm 5\text{ V}$ ,  $V_{LE} = 0$  (unless otherwise noted)**

PARAMETER		TEST CONDITION <sup>†</sup>		TL3016C			TL3016I			UNIT
				MIN	TYP	MAX	MIN	TYP	MAX	
$t_{pd1}$	Propagation delay time <sup>‡</sup>	$\Delta V_I = 100\text{ mV}$ , $V_{OD} = 5\text{ mV}$	$T_A = 25^\circ\text{C}$	7.8	10		7.8	10	ns	
			$T_A = \text{full range}$	7.8	11.2		7.8	12.2		
		$\Delta V_I = 100\text{ mV}$ , $V_{OD} = 20\text{ mV}$	$T_A = 25^\circ\text{C}$	7.6	10		7.6	10		
			$T_A = \text{full range}$	7.6	11.2		7.6	12.2		
$t_{sk(p)}$	Pulse skew ( $ t_{pd+} - t_{pd-} $ )	$\Delta V_I = 100\text{ mV}$ , $V_{OD} = 5\text{ mV}$ , $T_A = 25^\circ\text{C}$		0.5			0.5			ns
$t_{su}$	Setup time, LATCH ENABLE			2.5			2.5			ns

<sup>†</sup> Full range for the TL3016C is  $0^\circ\text{C}$  to  $70^\circ\text{C}$ . Full range for the TL3016I is  $-40^\circ\text{C}$  to  $85^\circ\text{C}$ .

<sup>‡</sup>  $t_{pd1}$  cannot be measured in automatic handling equipment with low values of overdrive. The TL3016 is 100% tested with a 1-V step and 500-mV overdrive at  $T_A = 25^\circ\text{C}$  only. Correlation tests have shown that  $t_{pd1}$  limits given can be ensured with this test, if additional dc tests are performed to ensure that all internal bias conditions are correct. For low overdrive conditions,  $V_{OS}$  is added to the overdrive.

**TYPICAL CHARACTERISTICS**
**Table of Graphs**

		FIGURE	
$I_{CC}$	Positive supply current	vs Input voltage	2
		vs Frequency	3
		vs Free-air temperature	4
$I_{CC}$	Negative supply current	vs Free-air temperature	5
$t_{pd}$	Propagation delay time	vs Overdrive voltage	6
		vs Supply voltage	7
		vs Input impedance	8
		vs Load capacitance	9
		vs Free-air temperature	10
$V_{IC}$	Common-mode input voltage	vs Free-air temperature	11
	Input threshold voltage (LATCH ENABLE)	vs Free-air temperature	12
$V_O$	Output voltage	vs Output source current	13
		vs Output sink current	14
$I_I$	Input current (LATCH ENABLE)	vs Input voltage	15

**TL3016, TL3016Y**  
**ULTRA-FAST LOW-POWER**  
**PRECISION COMPARATORS**

SLCS130D – MARCH 1997 – REVISED MARCH 2000

**TYPICAL CHARACTERISTICS**

**POSITIVE SUPPLY CURRENT**  
**vs**  
**INPUT VOLTAGE**

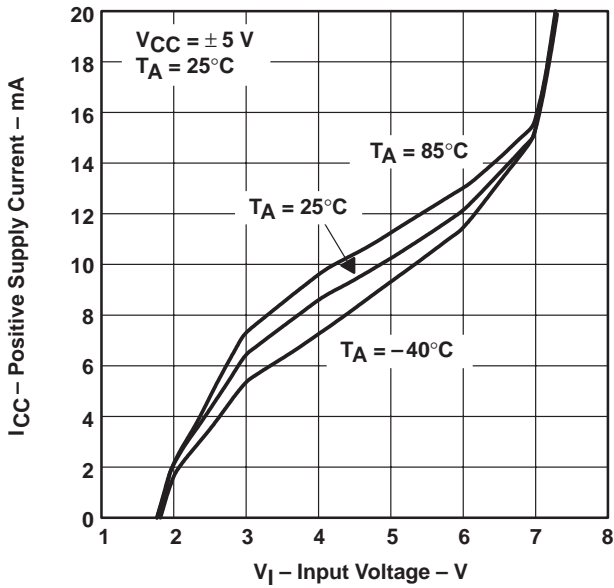

**Figure 2**

**POSITIVE SUPPLY CURRENT**  
**vs**  
**FREQUENCY**

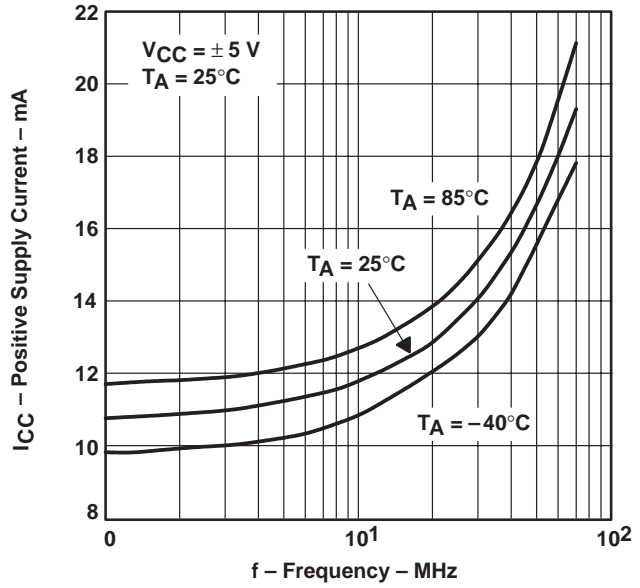

**Figure 3**

**POSITIVE SUPPLY CURRENT**  
**vs**  
**FREE-AIR TEMPERATURE**

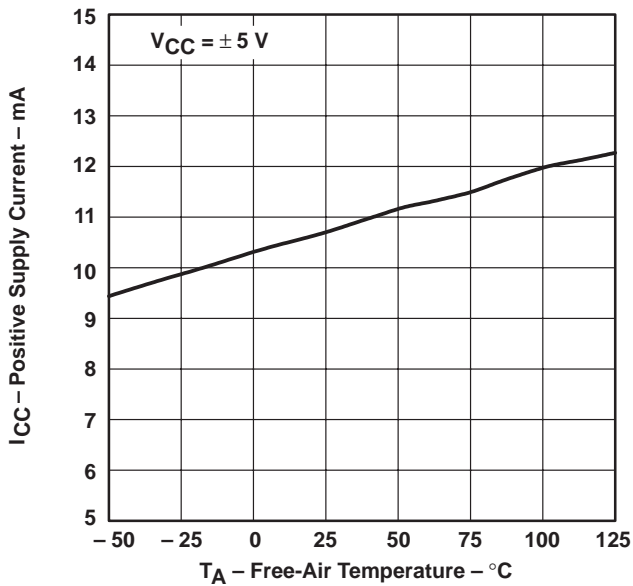

**Figure 4**

**NEGATIVE SUPPLY CURRENT**  
**vs**  
**FREE-AIR TEMPERATURE**

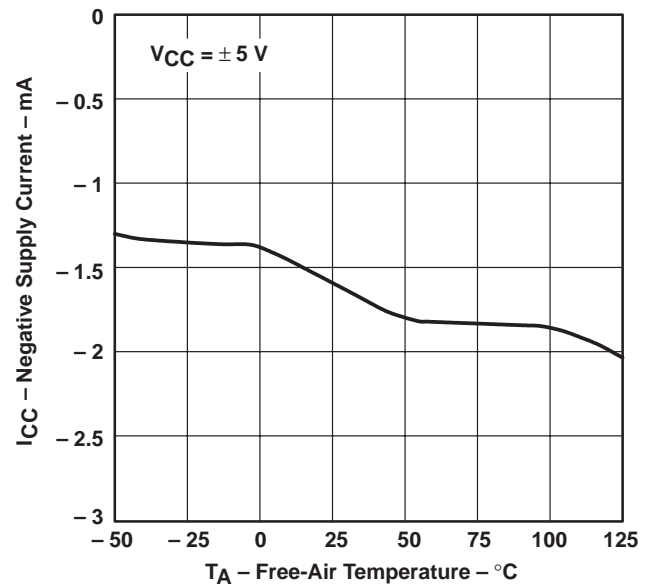

**Figure 5**





**TYPICAL CHARACTERISTICS**

**PROPAGATION DELAY TIME**  
**vs**  
**OVERDRIVE VOLTAGE**

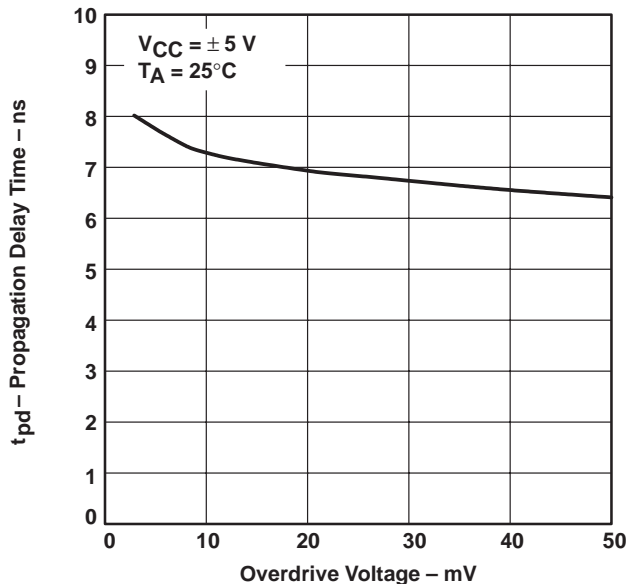

**Figure 6**

**PROPAGATION DELAY TIME**  
**vs**  
**SUPPLY VOLTAGE**

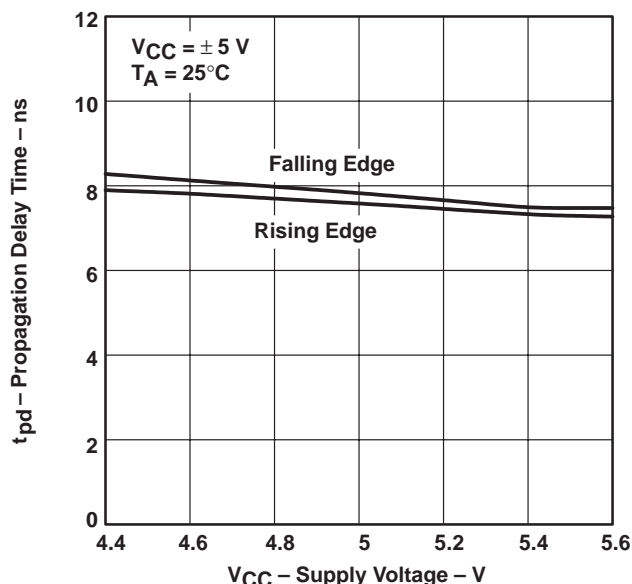

**Figure 7**

**PROPAGATION DELAY TIME**  
**vs**  
**INPUT IMPEDANCE**

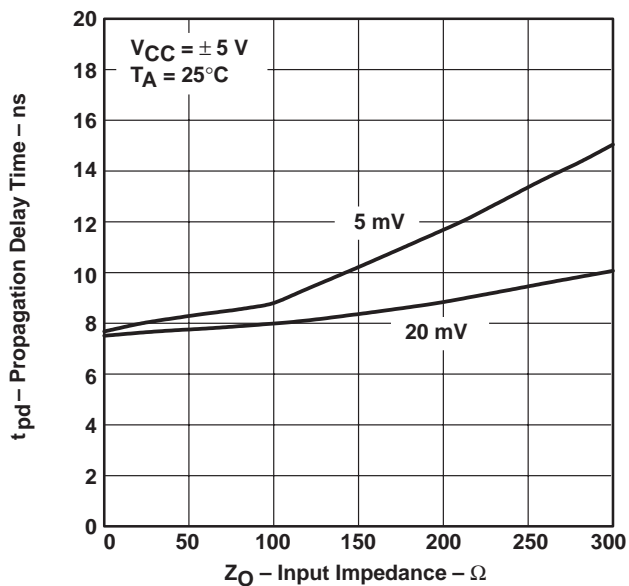

**Figure 8**

**PROPAGATION DELAY TIME**  
**vs**  
**LOAD CAPACITANCE**

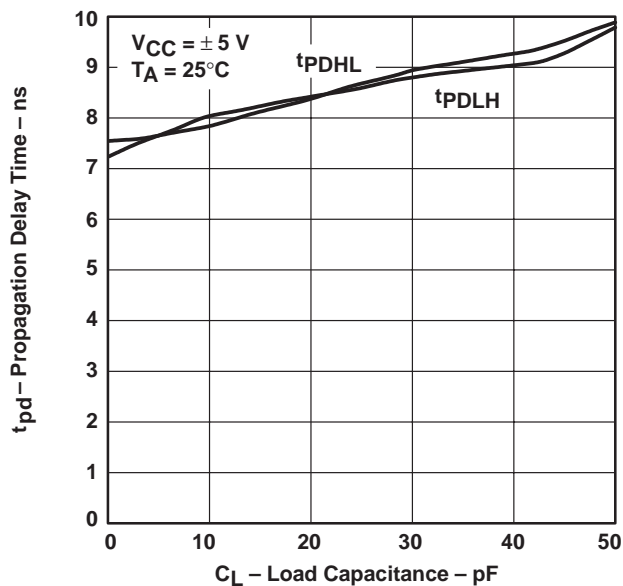

**Figure 9**

**TL3016, TL3016Y**  
**ULTRA-FAST LOW-POWER**  
**PRECISION COMPARATORS**

SLCS130D – MARCH 1997 – REVISED MARCH 2000

**TYPICAL CHARACTERISTICS**

**PROPAGATION DELAY TIME**  
**vs**  
**FREE-AIR TEMPERATURE**

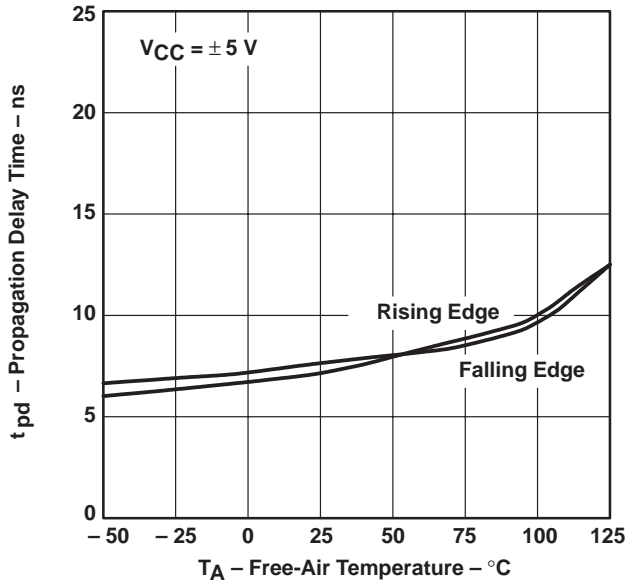

**Figure 10**

**COMMON-MODE INPUT VOLTAGE**  
**vs**  
**FREE-AIR TEMPERATURE**

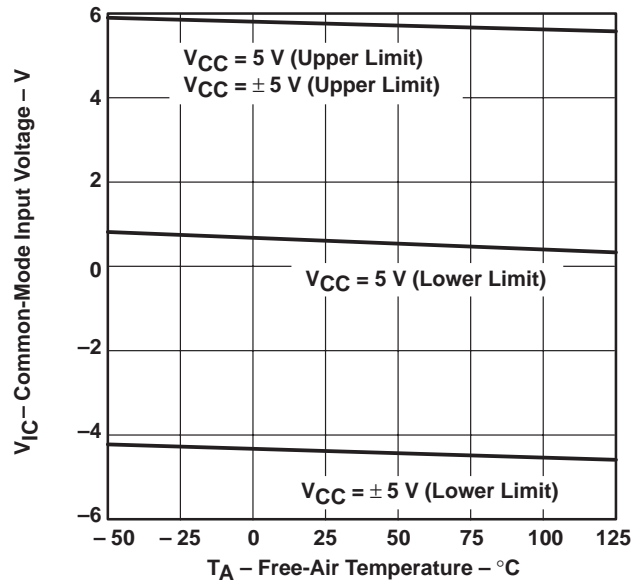

**Figure 11**

**INPUT THRESHOLD VOLTAGE (LATCH ENABLE)**  
**vs**  
**FREE-AIR TEMPERATURE**

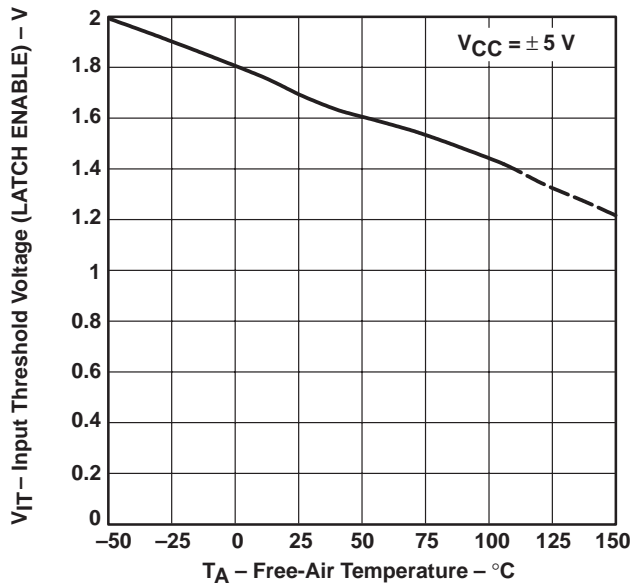

**Figure 12**

**OUTPUT VOLTAGE**  
**vs**  
**OUTPUT SOURCE CURRENT**

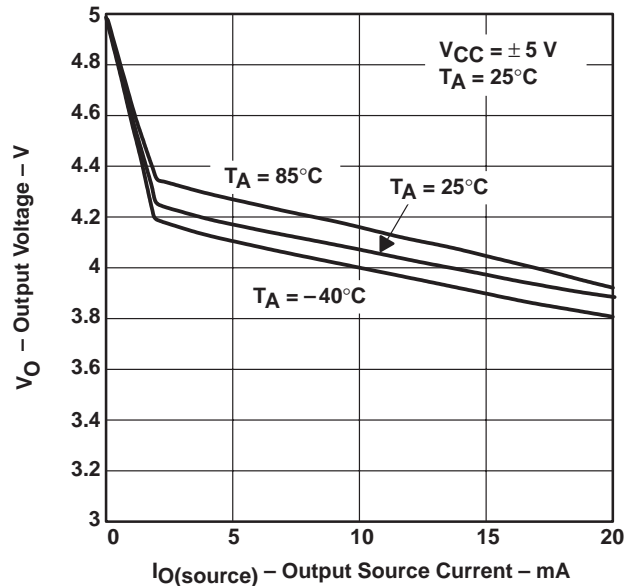

**Figure 13**



**TYPICAL CHARACTERISTICS**

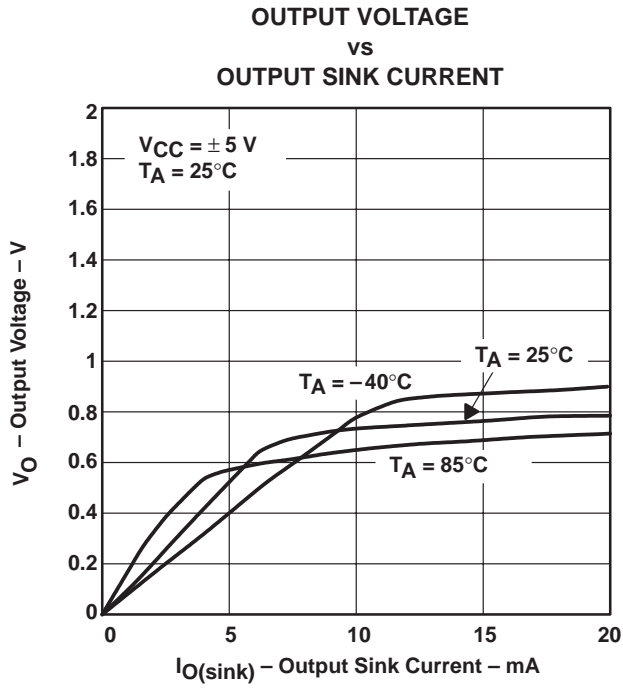

**Figure 14**

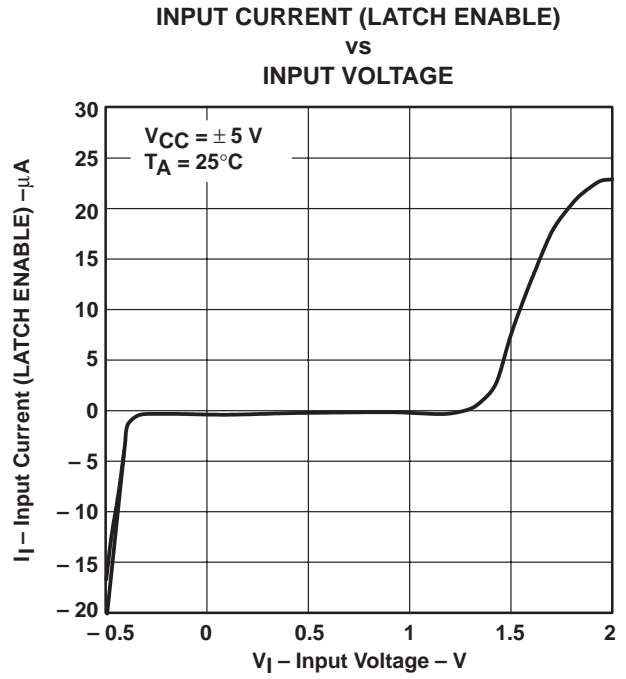

**Figure 15**

**PACKAGING INFORMATION**

Orderable Device	Status (1)	Package Type	Package Drawing	Pins	Package Qty	Eco Plan (2)	Lead finish/ Ball material (6)	MSL Peak Temp (3)	Op Temp (°C)	Device Marking (4/5)	Samples
TL3016CD	ACTIVE	SOIC	D	8	75	RoHS & Green	NIPDAU	Level-1-260C-UNLIM	0 to 70	3016C	<a href="#">Samples</a>
TL3016CDG4	ACTIVE	SOIC	D	8	75	RoHS & Green	NIPDAU	Level-1-260C-UNLIM	0 to 70	3016C	<a href="#">Samples</a>
TL3016CDR	ACTIVE	SOIC	D	8	2500	RoHS & Green	NIPDAU	Level-1-260C-UNLIM	0 to 70	3016C	<a href="#">Samples</a>
TL3016CPW	ACTIVE	TSSOP	PW	8	150	RoHS & Green	NIPDAU	Level-1-260C-UNLIM	0 to 70	T3016	<a href="#">Samples</a>
TL3016CPWR	ACTIVE	TSSOP	PW	8	2000	RoHS & Green	NIPDAU	Level-1-260C-UNLIM	0 to 70	T3016	<a href="#">Samples</a>
TL3016ID	ACTIVE	SOIC	D	8	75	RoHS & Green	NIPDAU	Level-1-260C-UNLIM	-40 to 85	3016I	<a href="#">Samples</a>
TL3016IDR	ACTIVE	SOIC	D	8	2500	RoHS & Green	NIPDAU	Level-1-260C-UNLIM	-40 to 85	3016I	<a href="#">Samples</a>
TL3016IDRG4	ACTIVE	SOIC	D	8	2500	TBD	Call TI	Call TI	-40 to 85		<a href="#">Samples</a>
TL3016IPW	ACTIVE	TSSOP	PW	8	150	RoHS & Green	NIPDAU	Level-1-260C-UNLIM	-40 to 85	Z3016	<a href="#">Samples</a>
TL3016IPWR	ACTIVE	TSSOP	PW	8	2000	RoHS & Green	NIPDAU	Level-1-260C-UNLIM	-40 to 85	Z3016	<a href="#">Samples</a>

(1) The marketing status values are defined as follows:

**ACTIVE:** Product device recommended for new designs.

**LIFEBUY:** TI has announced that the device will be discontinued, and a lifetime-buy period is in effect.

**NRND:** Not recommended for new designs. Device is in production to support existing customers, but TI does not recommend using this part in a new design.

**PREVIEW:** Device has been announced but is not in production. Samples may or may not be available.

**OBSOLETE:** TI has discontinued the production of the device.

(2) **RoHS:** TI defines "RoHS" to mean semiconductor products that are compliant with the current EU RoHS requirements for all 10 RoHS substances, including the requirement that RoHS substance do not exceed 0.1% by weight in homogeneous materials. Where designed to be soldered at high temperatures, "RoHS" products are suitable for use in specified lead-free processes. TI may reference these types of products as "Pb-Free".

**RoHS Exempt:** TI defines "RoHS Exempt" to mean products that contain lead but are compliant with EU RoHS pursuant to a specific EU RoHS exemption.

**Green:** TI defines "Green" to mean the content of Chlorine (Cl) and Bromine (Br) based flame retardants meet JS709B low halogen requirements of <=1000ppm threshold. Antimony trioxide based flame retardants must also meet the <=1000ppm threshold requirement.

(3) MSL, Peak Temp. - The Moisture Sensitivity Level rating according to the JEDEC industry standard classifications, and peak solder temperature.

(4) There may be additional marking, which relates to the logo, the lot trace code information, or the environmental category on the device.

<sup>(5)</sup> Multiple Device Markings will be inside parentheses. Only one Device Marking contained in parentheses and separated by a "~" will appear on a device. If a line is indented then it is a continuation of the previous line and the two combined represent the entire Device Marking for that device.

<sup>(6)</sup> Lead finish/Ball material - Orderable Devices may have multiple material finish options. Finish options are separated by a vertical ruled line. Lead finish/Ball material values may wrap to two lines if the finish value exceeds the maximum column width.

**Important Information and Disclaimer:**The information provided on this page represents TI's knowledge and belief as of the date that it is provided. TI bases its knowledge and belief on information provided by third parties, and makes no representation or warranty as to the accuracy of such information. Efforts are underway to better integrate information from third parties. TI has taken and continues to take reasonable steps to provide representative and accurate information but may not have conducted destructive testing or chemical analysis on incoming materials and chemicals. TI and TI suppliers consider certain information to be proprietary, and thus CAS numbers and other limited information may not be available for release.

In no event shall TI's liability arising out of such information exceed the total purchase price of the TI part(s) at issue in this document sold by TI to Customer on an annual basis.



## TAPE AND REEL INFORMATION

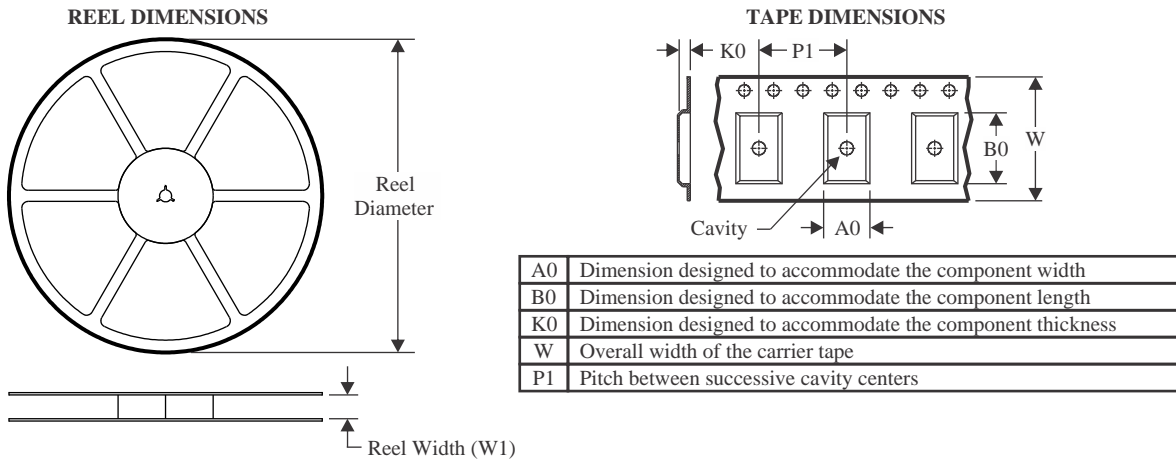

### QUADRANT ASSIGNMENTS FOR PIN 1 ORIENTATION IN TAPE

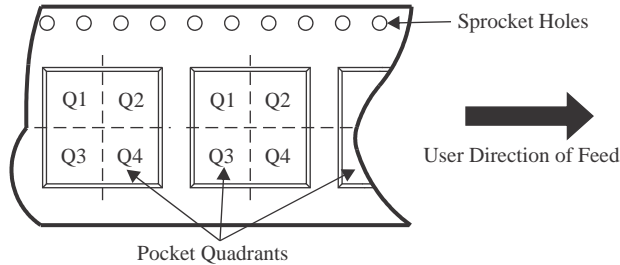

\*All dimensions are nominal

Device	Package Type	Package Drawing	Pins	SPQ	Reel Diameter (mm)	Reel Width W1 (mm)	A0 (mm)	B0 (mm)	K0 (mm)	P1 (mm)	W (mm)	Pin1 Quadrant
TL3016CDR	SOIC	D	8	2500	330.0	12.4	6.4	5.2	2.1	8.0	12.0	Q1
TL3016CPWR	TSSOP	PW	8	2000	330.0	12.4	7.0	3.6	1.6	8.0	12.0	Q1
TL3016IDR	SOIC	D	8	2500	330.0	12.4	6.4	5.2	2.1	8.0	12.0	Q1
TL3016IPWR	TSSOP	PW	8	2000	330.0	12.4	7.0	3.6	1.6	8.0	12.0	Q1

## TAPE AND REEL BOX DIMENSIONS

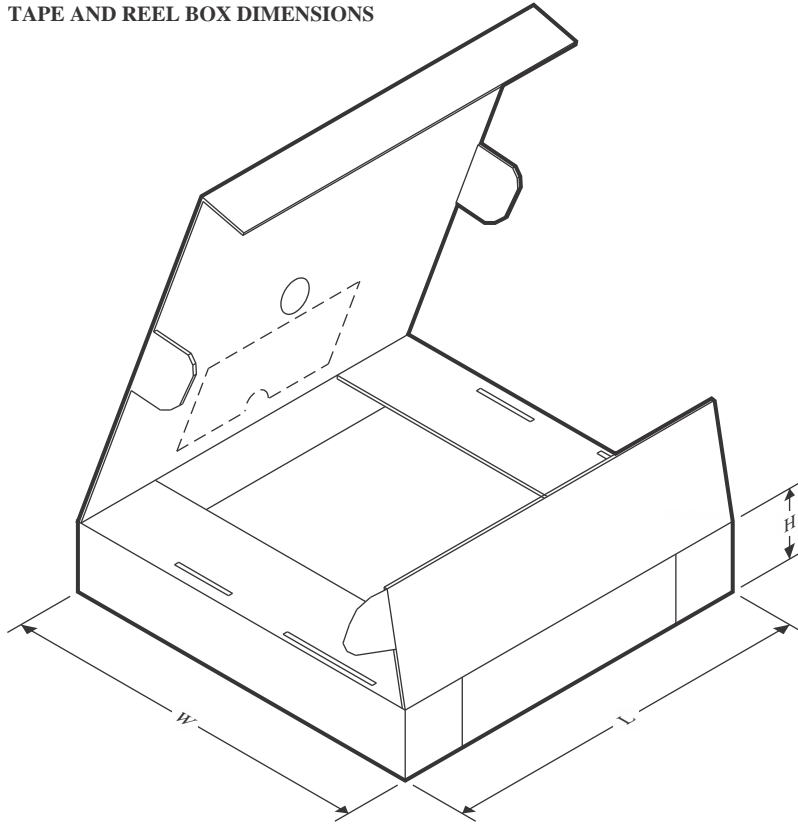

\*All dimensions are nominal

Device	Package Type	Package Drawing	Pins	SPQ	Length (mm)	Width (mm)	Height (mm)
TL3016CDR	SOIC	D	8	2500	350.0	350.0	43.0
TL3016CPWR	TSSOP	PW	8	2000	356.0	356.0	35.0
TL3016IDR	SOIC	D	8	2500	350.0	350.0	43.0
TL3016IPWR	TSSOP	PW	8	2000	367.0	367.0	35.0

## TUBE

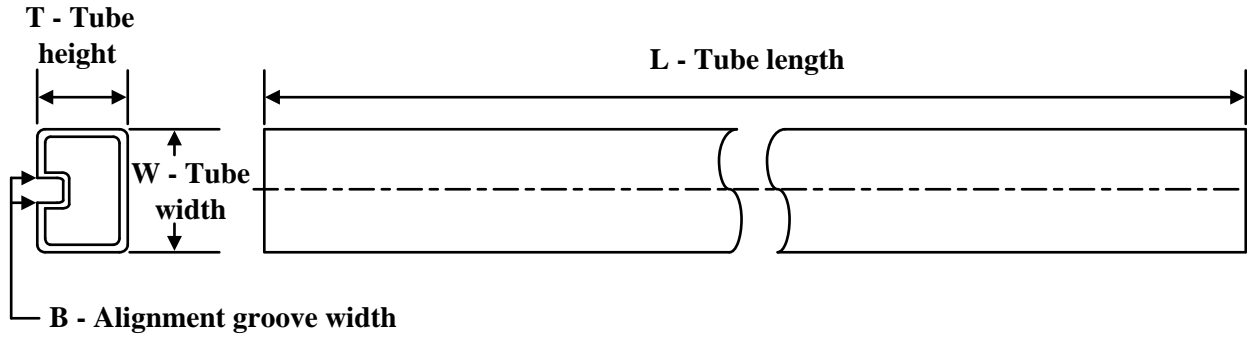

\*All dimensions are nominal

Device	Package Name	Package Type	Pins	SPQ	L (mm)	W (mm)	T (μm)	B (mm)
TL3016CD	D	SOIC	8	75	505.46	6.76	3810	4
TL3016CDG4	D	SOIC	8	75	505.46	6.76	3810	4
TL3016CPW	PW	TSSOP	8	150	530	10.2	3600	3.5
TL3016ID	D	SOIC	8	75	505.46	6.76	3810	4
TL3016IPW	PW	TSSOP	8	150	530	10.2	3600	3.5



**D0008A**

**PACKAGE OUTLINE**

**SOIC - 1.75 mm max height**

SMALL OUTLINE INTEGRATED CIRCUIT

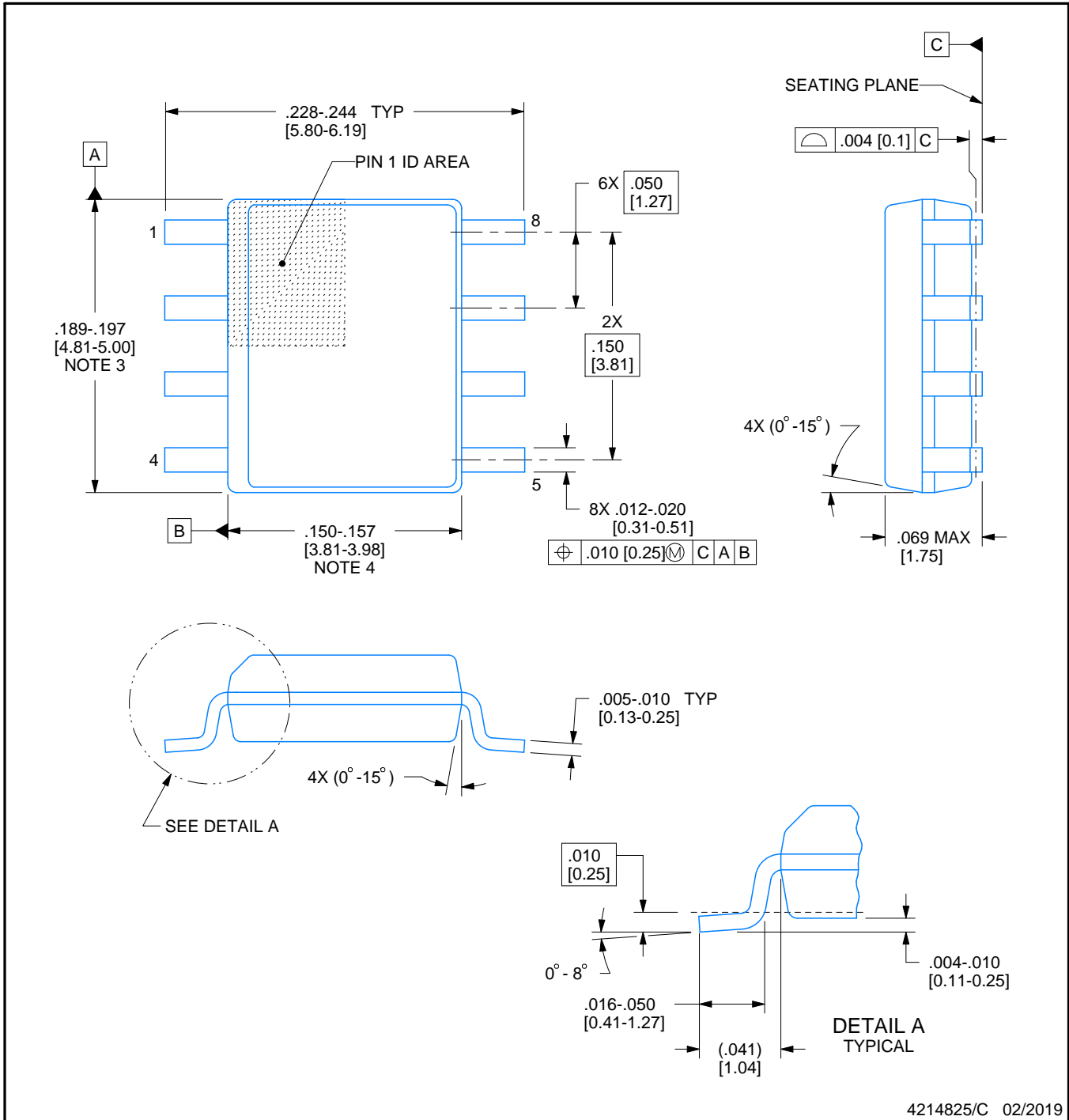

4214825/C 02/2019

NOTES:

1. Linear dimensions are in inches [millimeters]. Dimensions in parenthesis are for reference only. Controlling dimensions are in inches. Dimensioning and tolerancing per ASME Y14.5M.
2. This drawing is subject to change without notice.
3. This dimension does not include mold flash, protrusions, or gate burrs. Mold flash, protrusions, or gate burrs shall not exceed  $.006$  [0.15] per side.
4. This dimension does not include interlead flash.
5. Reference JEDEC registration MS-012, variation AA.

# EXAMPLE BOARD LAYOUT

**D0008A**

**SOIC - 1.75 mm max height**

SMALL OUTLINE INTEGRATED CIRCUIT

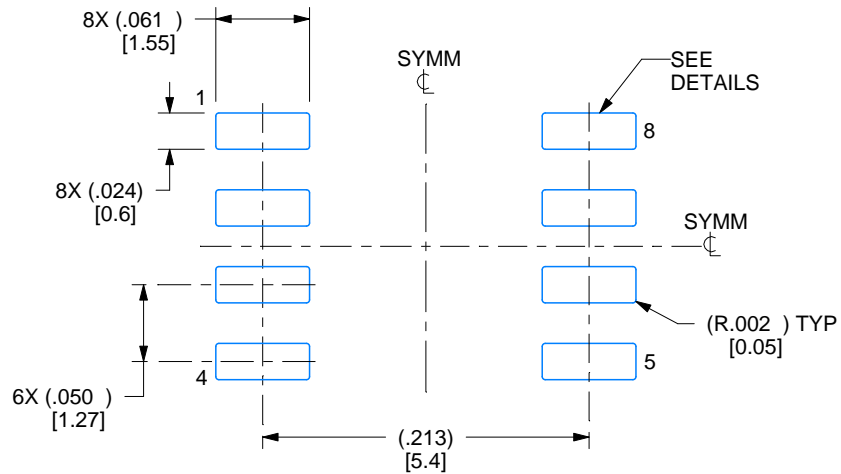

**LAND PATTERN EXAMPLE**  
 EXPOSED METAL SHOWN  
 SCALE:8X

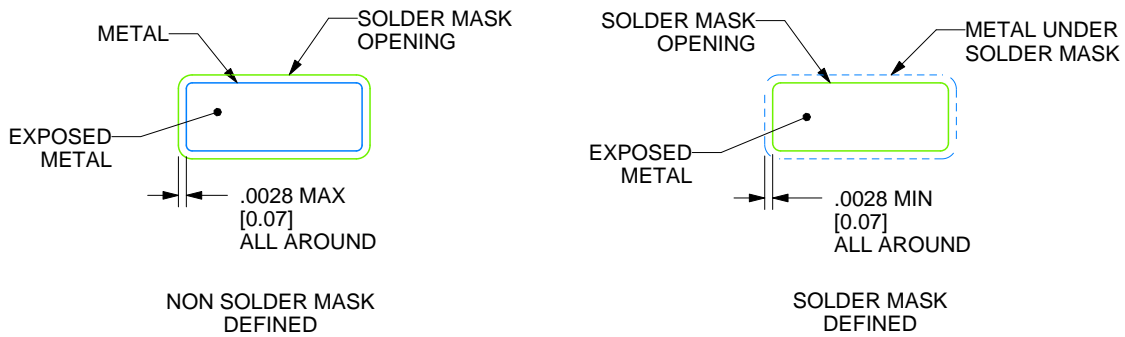

**SOLDER MASK DETAILS**

4214825/C 02/2019

NOTES: (continued)

- 6. Publication IPC-7351 may have alternate designs.
- 7. Solder mask tolerances between and around signal pads can vary based on board fabrication site.



# EXAMPLE STENCIL DESIGN

**D0008A**

**SOIC - 1.75 mm max height**

SMALL OUTLINE INTEGRATED CIRCUIT

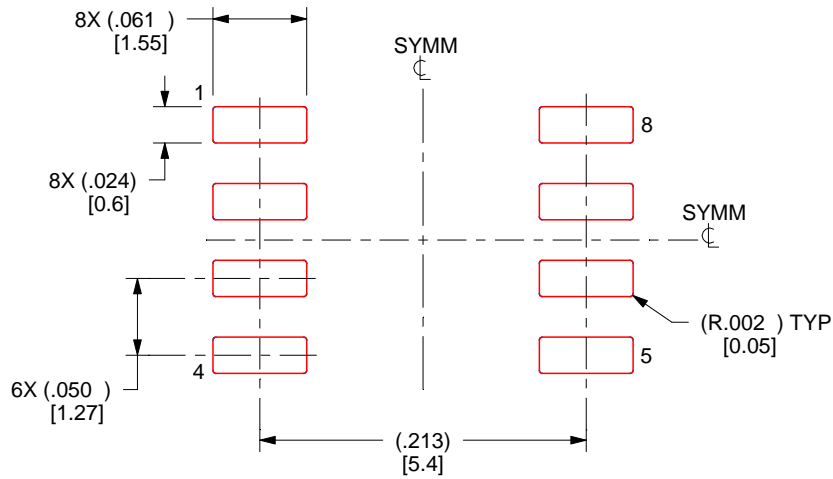

SOLDER PASTE EXAMPLE  
 BASED ON .005 INCH [0.125 MM] THICK STENCIL  
 SCALE:8X

4214825/C 02/2019

NOTES: (continued)

- 8. Laser cutting apertures with trapezoidal walls and rounded corners may offer better paste release. IPC-7525 may have alternate design recommendations.
- 9. Board assembly site may have different recommendations for stencil design.



# PACKAGE OUTLINE

PW0008A

TSSOP - 1.2 mm max height

SMALL OUTLINE PACKAGE

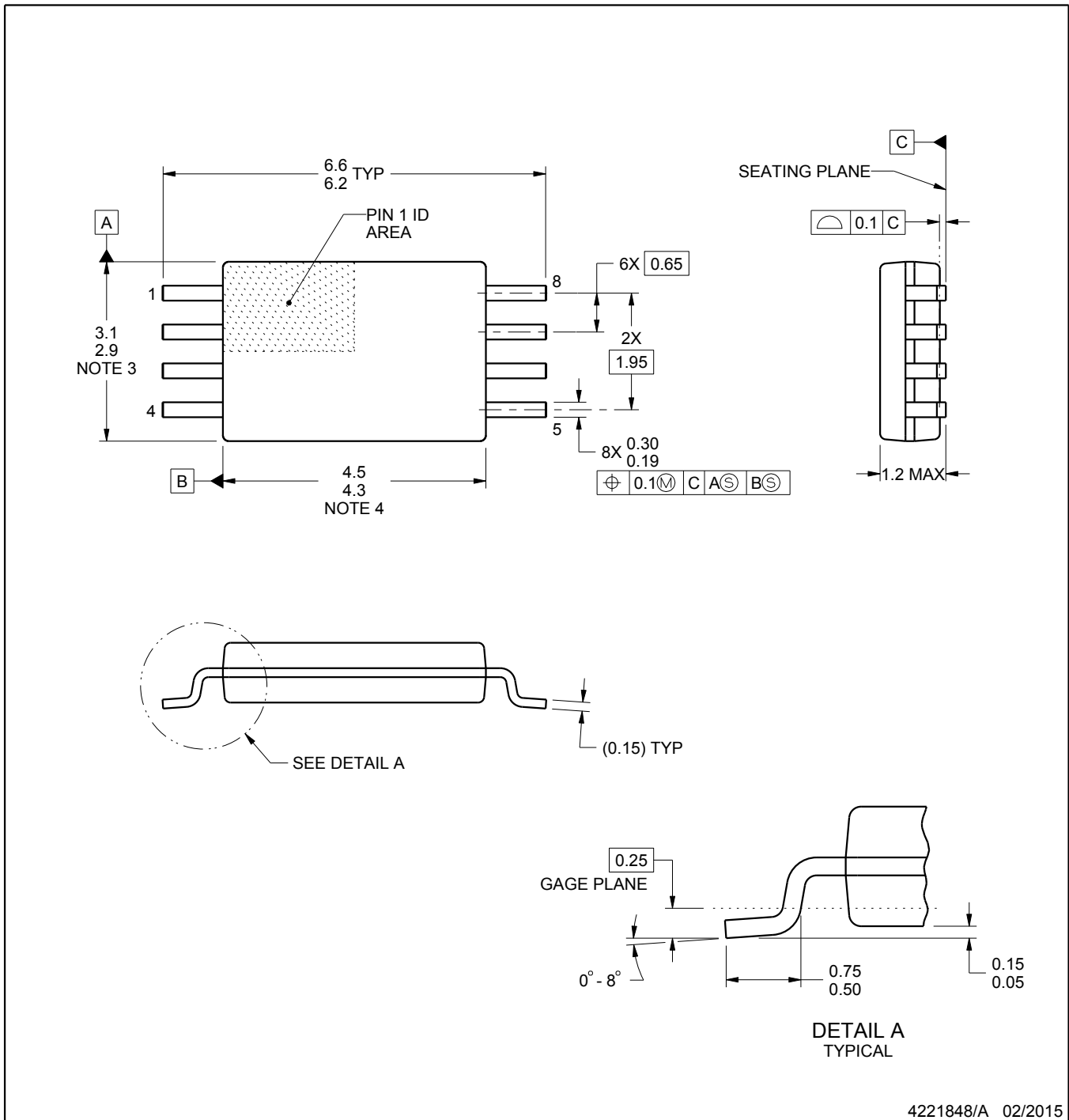

4221848/A 02/2015

NOTES:

1. All linear dimensions are in millimeters. Any dimensions in parenthesis are for reference only. Dimensioning and tolerancing per ASME Y14.5M.
2. This drawing is subject to change without notice.
3. This dimension does not include mold flash, protrusions, or gate burrs. Mold flash, protrusions, or gate burrs shall not exceed 0.15 mm per side.
4. This dimension does not include interlead flash. Interlead flash shall not exceed 0.25 mm per side.
5. Reference JEDEC registration MO-153, variation AA.

# EXAMPLE BOARD LAYOUT

PW0008A

TSSOP - 1.2 mm max height

SMALL OUTLINE PACKAGE

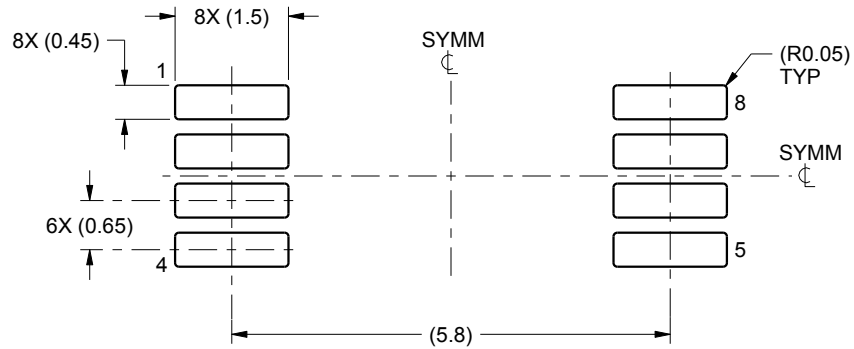

LAND PATTERN EXAMPLE  
SCALE:10X

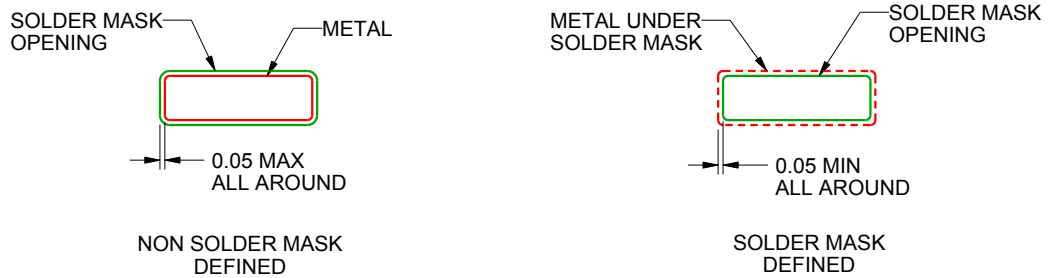

SOLDER MASK DETAILS  
NOT TO SCALE

4221848/A 02/2015

NOTES: (continued)

- 6. Publication IPC-7351 may have alternate designs.
- 7. Solder mask tolerances between and around signal pads can vary based on board fabrication site.

# EXAMPLE STENCIL DESIGN

PW0008A

TSSOP - 1.2 mm max height

SMALL OUTLINE PACKAGE

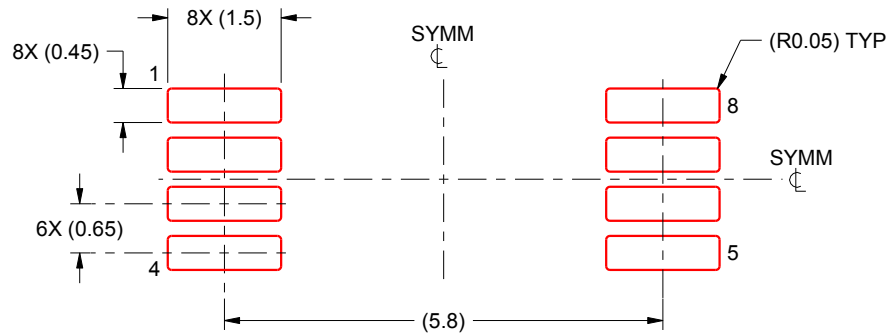

SOLDER PASTE EXAMPLE  
 BASED ON 0.125 mm THICK STENCIL  
 SCALE:10X

4221848/A 02/2015

NOTES: (continued)

- 8. Laser cutting apertures with trapezoidal walls and rounded corners may offer better paste release. IPC-7525 may have alternate design recommendations.
- 9. Board assembly site may have different recommendations for stencil design.

## IMPORTANT NOTICE AND DISCLAIMER

TI PROVIDES TECHNICAL AND RELIABILITY DATA (INCLUDING DATA SHEETS), DESIGN RESOURCES (INCLUDING REFERENCE DESIGNS), APPLICATION OR OTHER DESIGN ADVICE, WEB TOOLS, SAFETY INFORMATION, AND OTHER RESOURCES "AS IS" AND WITH ALL FAULTS, AND DISCLAIMS ALL WARRANTIES, EXPRESS AND IMPLIED, INCLUDING WITHOUT LIMITATION ANY IMPLIED WARRANTIES OF MERCHANTABILITY, FITNESS FOR A PARTICULAR PURPOSE OR NON-INFRINGEMENT OF THIRD PARTY INTELLECTUAL PROPERTY RIGHTS.

These resources are intended for skilled developers designing with TI products. You are solely responsible for (1) selecting the appropriate TI products for your application, (2) designing, validating and testing your application, and (3) ensuring your application meets applicable standards, and any other safety, security, regulatory or other requirements.

These resources are subject to change without notice. TI grants you permission to use these resources only for development of an application that uses the TI products described in the resource. Other reproduction and display of these resources is prohibited. No license is granted to any other TI intellectual property right or to any third party intellectual property right. TI disclaims responsibility for, and you will fully indemnify TI and its representatives against, any claims, damages, costs, losses, and liabilities arising out of your use of these resources.

TI's products are provided subject to [TI's Terms of Sale](#) or other applicable terms available either on [ti.com](https://www.ti.com) or provided in conjunction with such TI products. TI's provision of these resources does not expand or otherwise alter TI's applicable warranties or warranty disclaimers for TI products.

TI objects to and rejects any additional or different terms you may have proposed.

Mailing Address: Texas Instruments, Post Office Box 655303, Dallas, Texas 75265  
Copyright © 2024, Texas Instruments Incorporated



## OUR CERTIFICATE

DiGi provide top-quality products and perfect service for customer worldwide through standardization, technological innovation and continuous improvement. DiGi through third-party certification, we stricly control the quality of products and services. Welcome your RFQ to

Email: [Info@DiGi-Electronics.com](mailto:Info@DiGi-Electronics.com)



Tel: +00 852-30501935

RFQ Email: [Info@DiGi-Electronics.com](mailto:Info@DiGi-Electronics.com)

DiGi is a global authorized distributor of electronic components.