

TLV2470IPG4 Datasheet

www.digi-electronics.com

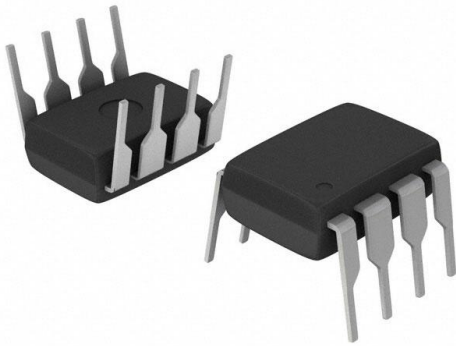

<https://www.DiGi-Electronics.com>

| | |
|------------------------------|--|
| DiGi Electronics Part Number | TLV2470IPG4-DG |
| Manufacturer | Texas Instruments |
| Manufacturer Product Number | TLV2470IPG4 |
| Description | IC OPAMP GP 1 CIRCUIT 8DIP |
| Detailed Description | General Purpose Amplifier 1 Circuit Rail-to-Rail 8-P DIP |



Tel: +00 852-30501935

RFQ Email: Info@DiGi-Electronics.com

DiGi is a global authorized distributor of electronic components.

Purchase and inquiry

Manufacturer Product Number:

TLV2470IPG4

Series:

-

Amplifier Type:

General Purpose

Output Type:

Rail-to-Rail

Gain Bandwidth Product:

2.8 MHz

Voltage - Input Offset:

250 μ V

Current - Output / Channel:

35 mA

Voltage - Supply Span (Max):

6 V

Mounting Type:

Through Hole

Supplier Device Package:

8-PDIP

Manufacturer:

Texas Instruments

Product Status:

Obsolete

Number of Circuits:

1

Slew Rate:

1.5V/ μ s

Current - Input Bias:

2.5 pA

Current - Supply:

600 μ A

Voltage - Supply Span (Min):

2.7 V

Operating Temperature:

-40°C ~ 125°C

Package / Case:

8-DIP (0.300", 7.62mm)

Base Product Number:

TLV247

Environmental & Export classification

RoHS Status:

ROHS3 Compliant

REACH Status:

REACH Unaffected

HTSUS:

8542.33.0001

Moisture Sensitivity Level (MSL):

1 (Unlimited)

ECCN:

EAR99

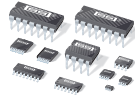

FAMILY OF 600µA/Ch 2.8MHz RAIL-TO-RAIL INPUT/OUTPUT HIGH-DRIVE OPERATIONAL AMPLIFIERS WITH SHUTDOWN

FEATURES

- **CMOS Rail-To-Rail Input/Output**
- **Input Bias Current: 2.5pA**
- **Low Supply Current: 600µA/Channel**
- **Ultra-Low Power Shutdown Mode:**
 $I_{DD(SHDN)}$: 350nA/ch at 3V
 $I_{DD(SHDN)}$: 1000nA/ch at 5V
- **Gain-Bandwidth Product: 2.8MHz**
- **High Output Drive Capability:**
 - $\pm 10\text{mA}$ at 180mV
 - $\pm 35\text{mA}$ at 500mV
- **Input Offset Voltage: 250µV (typ)**
- **Supply Voltage Range: 2.7V to 6V**
- **Ultra-Small Packaging**
 - SOT23-5 or -6 (TLV2470/1)
 - MSOP-8 or -10 (TLV2472/3)

DESCRIPTION

The TLV247x is a family of CMOS rail-to-rail input/output operational amplifiers that establishes a new performance point for supply current versus ac performance. These devices consume just 600µA/channel while offering 2.8MHz of gain-bandwidth product. Along with increased ac performance, the amplifier provides high output drive capability, solving a major shortcoming of older micropower operational amplifiers. The TLV247x can swing to within 180mV of each supply rail while driving a 10mA load. For non-RRO applications, the TLV247x can supply $\pm 35\text{mA}$ at 500mV off the rail. Both the inputs and outputs swing rail-to-rail for increased dynamic range in low-voltage applications. This performance makes the TLV247x family ideal for sensor interface, portable medical equipment, and other data acquisition circuits.

FAMILY PACKAGE TABLE

| DEVICE | NUMBER OF CHANNELS | PACKAGE TYPES | | | | | SHUTDOWN | UNIVERSAL EVM BOARD |
|---------|--------------------|---------------|------|-------|-------|------|----------|--|
| | | PDIP | SOIC | SOT23 | TSSOP | MSOP | | |
| TLV2470 | 1 | 8 | 8 | 6 | — | — | Yes | Refer to the EVM Selection Guide (SLOU060) |
| TLV2471 | 1 | 8 | 8 | 5 | — | — | — | |
| TLV2472 | 2 | 8 | 8 | — | — | 8 | — | |
| TLV2473 | 2 | 14 | 14 | — | — | 10 | Yes | |
| TLV2474 | 4 | 14 | 14 | — | 14 | — | — | |
| TLV2475 | 4 | 16 | 16 | — | 16 | — | Yes | |

A SELECTION OF SINGLE-SUPPLY OPERATIONAL AMPLIFIER PRODUCTS⁽¹⁾

| DEVICE | V_{DD} (V) | V_{IO} (µV) | BW (MHz) | SLEW RATE (V/µs) | I_{DD} (per channel) (µA) | OUTPUT DRIVE | RAIL-TO-RAIL |
|---------|--------------|---------------|----------|------------------|-----------------------------|-------------------|--------------|
| TLV247X | 2.7 – 6.0 | 250 | 2.8 | 1.5 | 600 | $\pm 35\text{mA}$ | I/O |
| TLV245X | 2.7 – 6.0 | 20 | 0.22 | 0.11 | 23 | $\pm 10\text{mA}$ | I/O |
| TLV246X | 2.7 – 6.0 | 150 | 6.4 | 1.6 | 550 | $\pm 90\text{mA}$ | I/O |
| TLV277X | 2.5 – 6.0 | 360 | 5.1 | 10.5 | 1000 | $\pm 10\text{mA}$ | O |

(1) All specifications measured at 5V.



Please be aware that an important notice concerning availability, standard warranty, and use in critical applications of Texas Instruments semiconductor products and disclaimers thereto appears at the end of this data sheet.

PowerPAD is a trademark of Texas Instruments.
 Microsim PARTS is a trademark of MicroSim Corporation.
 Microsim PSpice is a registered trademark of MicroSim Corporation.
 All other trademarks are the property of their respective owners.



This integrated circuit can be damaged by ESD. Texas Instruments recommends that all integrated circuits be handled with appropriate precautions. Failure to observe proper handling and installation procedures can cause damage.

ESD damage can range from subtle performance degradation to complete device failure. Precision integrated circuits may be more susceptible to damage because very small parametric changes could cause the device not to meet its published specifications.

TLV2470 and TLV2471 AVAILABLE OPTIONS⁽¹⁾

| T _A | PACKAGED DEVICES | | | |
|-----------------|----------------------------------|----------------------------|--------------|--------------------------|
| | SMALL OUTLINE (D) ⁽²⁾ | SOT23 | | PLASTIC DIP (P) |
| | | (DBV) ⁽²⁾ | SYMBOL | |
| 0°C to +70°C | TLV2470CD TLV2471CD | TLV2470CDBV TLV2471CDBV | VAUC VAVC | TLV2470CP TLV2471CP |
| –40°C to +125°C | TLV2470ID TLV2471ID | TLV2470IDBV TLV2471IDBV | VAUI VAVI | TLV2470IP TLV2471IP |
| | TLV2470AID TLV2471AID | — | — | TLV2470AIP TLV2471AIP |

(1) For the most current package and ordering information see the Package Option Addendum at the end of this document, or see the TI web site at www.ti.com.

(2) This package is available taped and reeled. To order this packaging option, add an R suffix to the part number (for example, TLV2470CDR).

TLV2472 AND TLV2473 AVAILABLE OPTIONS⁽¹⁾

| T _A | PACKAGED DEVICES | | | | | | |
|-----------------|----------------------------------|----------------------|-----------------------|----------------------|-----------------------|-----------------|-----------------|
| | SMALL OUTLINE (D) ⁽²⁾ | MSOP | | MSOP | | PLASTIC DIP (N) | PLASTIC DIP (P) |
| | | (DGN) ⁽²⁾ | SYMBOL ⁽³⁾ | (DGQ) ⁽²⁾ | SYMBOL ⁽³⁾ | | |
| 0°C to +70°C | TLV2472CD TLV2473CD | TLV2472CDGN — | xxTIABU — | — TLV2473CDGQ | — xxTIABW | — TLV2473CN | TLV2472CP — |
| –40°C to +125°C | TLV2472ID TLV2473ID | TLV2472IDGN — | xxTIABV — | — TLV2473IDGQ | — xxTIABX | — TLV2473IN | TLV2472IP — |
| | TLV2472AID TLV2473AID | — | — | — | — | — TLV2473AIN | TLV2472AIP — |

(1) For the most current package and ordering information see the Package Option Addendum at the end of this document, or see the TI web site at www.ti.com.

(2) This package is available taped and reeled. To order this packaging option, add an R suffix to the part number (for example, TLV2472CDR).

(3) xx represents the device date code.

TLV2474 and TLV2475 AVAILABLE OPTIONS⁽¹⁾

| T _A | PACKAGED DEVICES | | |
|-----------------|----------------------------------|--------------------------|------------------------------|
| | SMALL OUTLINE (D) ⁽²⁾ | PLASTIC DIP (N) | TSSOP (PWP) ⁽²⁾ |
| 0°C to +70°C | TLV2474CD TLV2475CD | TLV2474CN TLV2475CN | TLV2474CPWP TLV2475CPWP |
| –40°C to +125°C | TLV2474ID TLV2475ID | TLV2474IN TLV2475IN | TLV2474IPWP TLV2475IPWP |
| | TLV2474AID TLV2475AID | TLV2474AIN TLV2475AIN | TLV2474AIPWP TLV2475AIPWP |

(1) For the most current package and ordering information see the Package Option Addendum at the end of this document, or see the TI web site at www.ti.com.

(2) This package is available taped and reeled. To order this packaging option, add an R suffix to the part number (for example, TLV2474CDR).

TLV247X PACKAGE PINOUTS

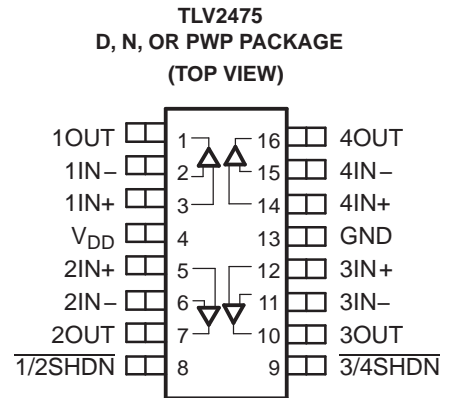
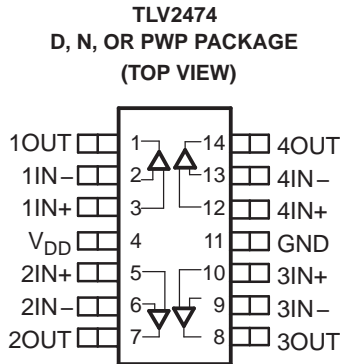
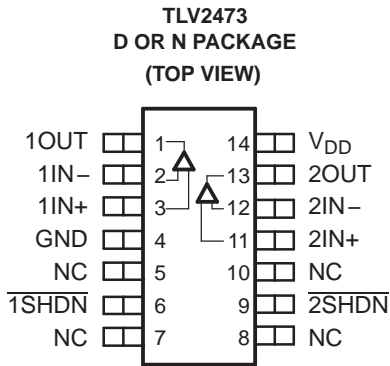
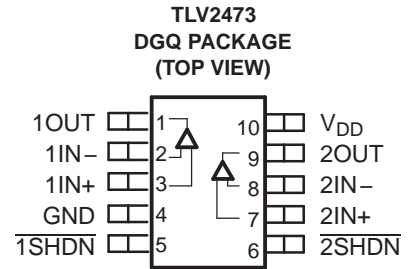
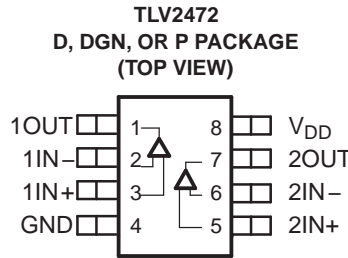
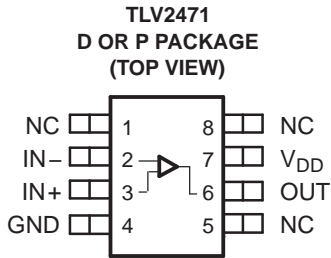
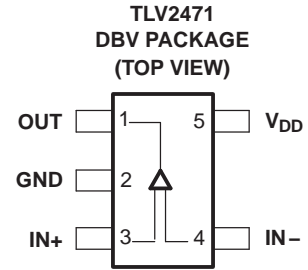
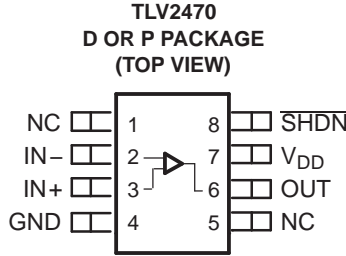
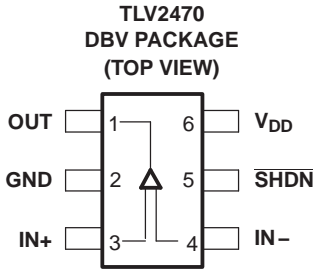

NC – No internal connection

TYPICAL PIN 1 INDICATORS

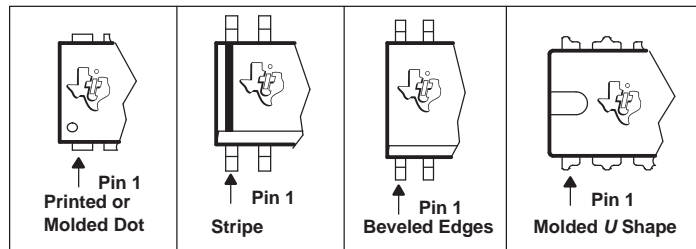

DESCRIPTION (CONTINUED)

Three members of the family (TLV2470/3/5) offer a shutdown terminal for conserving battery life in portable applications. During shutdown, the outputs are placed in a high-impedance state and the amplifier consumes only 350nA/channel. The family is fully specified at 3V and 5V across an expanded industrial temperature range (–40°C to +125°C). The singles and duals are available in the SOT23 and MSOP packages, while the quads are available in TSSOP. The TLV2470 offers an amplifier with shutdown functionality all in a SOT23-6 package, making it perfect for high-density power-sensitive circuits.

ABSOLUTE MAXIMUM RATINGS⁽¹⁾

Over operating free-air temperature range, unless otherwise noted.

| | | UNIT |
|--|----------|--|
| Supply voltage, V_{DD} ⁽²⁾ | | 7V |
| Differential input voltage, V_{ID} | | $\pm V_{DD}$ |
| Continuous total power dissipation | | See Dissipation Rating table |
| Operating free-air temperature range, T_A | C-suffix | 0°C to +70°C |
| | I-suffix | –40°C to +125°C |
| Maximum junction temperature, T_J | | +150°C |
| Storage temperature range, T_{stg} | | –65°C to +150°C |
| Lead temperature 1,6 mm (1/16 inch) from case for 10 seconds | | +260°C |

- (1) Stresses beyond those listed under *absolute maximum ratings* may cause permanent damage to the device. These are stress ratings only, and functional operation of the device at these or any other conditions beyond those indicated under *recommended operating conditions* is not implied. Exposure to absolute-maximum-rated conditions for extended periods may affect device reliability.
- (2) All voltage values, except differential voltages, are with respect to GND.

DISSIPATION RATING TABLE

| PACKAGE | θ_{JC} (°C/W) | θ_{JA} (°C/W) | $T_A \leq +25^\circ\text{C}$ POWER RATING |
|------------|-------------------------|-------------------------|--|
| D (8) | 38.3 | 176 | 710mW |
| D (14) | 26.9 | 122.3 | 1022mW |
| D (16) | 25.7 | 114.7 | 1090mW |
| DBV (5) | 55 | 324.1 | 385mW |
| DBV (6) | 55 | 294.3 | 425mW |
| DGN (8) | 4.7 | 52.7 | 2.37W |
| DGQ (10) | 4.7 | 52.3 | 2.39W |
| N (14, 16) | 32 | 78 | 1600mW |
| P (8) | 41 | 104 | 1200mW |
| PWP (14) | 2.07 | 30.7 | 4.07W |
| PWP (16) | 2.07 | 29.7 | 4.21W |

RECOMMENDED OPERATING CONDITIONS

| | | MIN | MAX | UNIT |
|--|---------------|------------|----------|------|
| Supply voltage, V_{DD} | Single supply | 2.7 | 6 | V |
| | Split supply | ± 1.35 | ± 3 | |
| Common-mode input voltage range, V_{ICR} | | 0 | V_{DD} | V |
| Operating free-air temperature, T_A | C-suffix | 0 | +70 | °C |
| | I-suffix | –40 | +125 | |
| Shutdown on/off voltage level ⁽¹⁾ | V_{IH} | 2 | | V |
| | V_{IL} | | 0.8 | |

- (1) Relative to GND.

ELECTRICAL CHARACTERISTICS

At specified free-air temperature, $V_{DD} = 3V$, unless otherwise noted.

| PARAMETER | TEST CONDITIONS | $T_A^{(1)}$ | MIN | TYP | MAX | UNIT | |
|--|--|-------------------|------------|------|-----------|------------------|---------|
| V_{IO} Input offset voltage | | TLV247x | +25°C | 250 | 2200 | μV | |
| | | | Full range | | 2400 | | |
| | | TLV247xA | +25°C | 250 | 1600 | | |
| | | | Full range | | 1800 | | |
| α_{VIO} Temperature coefficient of input offset voltage | $V_{IC} = V_{DD}/2$, $V_O = V_{DD}/2$, $R_S = 50\Omega$ | | | 0.4 | | $\mu V/^\circ C$ | |
| | | 25°C | 1.5 | 50 | | | |
| I_{IO} Input offset current | | TLV247xC | Full range | | | 100 | μA |
| | | TLV247xI | Full range | | | 300 | |
| I_{IB} Input bias current | | +25°C | | 2 | 50 | | |
| | TLV247xC | Full range | | | 100 | | |
| | TLV247xI | Full range | | | 300 | | |
| V_{OH} High-level output voltage | $V_{IC} = V_{DD}/2$ | $I_{OH} = -2.5mA$ | +25°C | 2.85 | 2.94 | V | |
| | | | Full range | | 2.8 | | |
| | | $I_{OH} = -10mA$ | +25°C | 2.6 | 2.74 | | |
| | | | Full range | | 2.5 | | |
| V_{OL} Low-level output voltage | $V_{IC} = V_{DD}/2$ | $I_{OL} = 2.5mA$ | +25°C | | 0.07 | 0.15 | V |
| | | | Full range | | | 0.2 | |
| | | $I_{OL} = 10mA$ | +25°C | | 0.2 | 0.35 | |
| | | | Full range | | | 0.5 | |
| I_{OS} Short-circuit output current | Sourcing | | +25°C | 30 | | mA | |
| | | | Full range | | 20 | | |
| | Sinking | | +25°C | 30 | | | |
| | | | Full range | | 20 | | |
| I_O Output current | $V_O = 0.5V$ from rail | | +25°C | | ± 22 | mA | |
| A_{VD} Large-signal differential voltage amplification | $V_{O(PP)} = 1V$, $R_L = 10k\Omega$ | | +25°C | 90 | 116 | dB | |
| | | | Full range | | 88 | | |
| $r_{i(d)}$ Differential input resistance | | | +25°C | | 10^{12} | Ω | |
| C_{IC} Common-mode input capacitance | $f = 10kHz$ | | +25°C | | 19.3 | pF | |
| z_o Closed-loop output impedance | $f = 10kHz$, $A_V = 10$ | | +25°C | | 2 | Ω | |
| CMRR Common-mode rejection ratio | $V_{IC} = 0V$ to $3V$, $R_S = 50\Omega$ | | +25°C | 61 | 78 | dB | |
| | | TLV247xC | Full range | | 59 | | |
| | | TLV247xI | Full range | | 58 | | |

(1) Full range is 0°C to +70°C for C-suffix and –40°C to +125°C for I-suffix. If not specified, full range is –40°C to +125°C.

ELECTRICAL CHARACTERISTICS (continued)

At specified free-air temperature, $V_{DD} = 3V$, unless otherwise noted.

| PARAMETER | | TEST CONDITIONS | | $T_A^{(1)}$ | MIN | TYP | MAX | UNIT |
|----------------|---|---|----------|-------------|-----|-----|------|---------|
| k_{SVR} | Supply voltage rejection ratio ($\Delta V_{DD}/\Delta V_{IO}$) | $V_{DD} = 2.7V$ to $6V$, $V_{IC} = V_{DD}/2$, No load | | +25°C | 74 | 90 | dB | |
| | | | | Full range | 66 | | | |
| | | $V_{DD} = 3V$ to $5V$, $V_{IC} = V_{DD}/2$, No load | | +25°C | 77 | 92 | | |
| | | | | Full range | 68 | | | |
| I_{DD} | Supply current (per channel) | $V_O = 1.5V$, No load | | +25°C | | 550 | 750 | μA |
| | | | | Full range | | | 800 | |
| $I_{DD(SHDN)}$ | Supply current in shutdown mode (TLV2470, TLV2473, TLV2475) (per channel) | $\overline{SHDN} = 0V$ | | +25°C | | 350 | 1500 | nA |
| | | | TLV247xC | Full range | | | 2000 | |
| | | | TLV247xI | Full range | | | 4000 | |

(1) Full range is 0°C to +70°C for C-suffix and –40°C to +125°C for I-suffix. If not specified, full range is –40°C to +125°C.

OPERATING CHARACTERISTICS

At specified free-air temperature, $V_{DD} = 3V$, unless otherwise noted.

| PARAMETER | | TEST CONDITIONS | | $T_A^{(1)}$ | MIN | TYP | MAX | UNIT |
|-------------|--------------------------------------|---|--|-------------|-------|-------|-----------------|---------|
| SR | Slew rate at unity gain | $V_{O(PP)} = 0.8V$, $C_L = 150pF$, $R_L = 10k\Omega$ | | +25°C | 1.1 | 1.4 | V/ μs | |
| | | | | Full range | 0.6 | | | |
| V_n | Equivalent input noise voltage | $f = 100Hz$ | | +25°C | | 28 | nV/ \sqrt{Hz} | |
| | | $f = 1kHz$ | | +25°C | | 15 | | |
| I_n | Equivalent input noise current | $f = 1kHz$ | | +25°C | | 0.405 | pA/ \sqrt{Hz} | |
| THD+N | Total harmonic distortion plus noise | $V_{O(PP)} = 2V$, $R_L = 10k\Omega$, $f = 1kHz$ | | $A_V = 1$ | +25°C | | 0.02% | |
| | | | | $A_V = 10$ | | 0.1% | | |
| | | | | $A_V = 100$ | | 0.5% | | |
| $t_{(on)}$ | Amplifier turn-on time | $R_L = OPEN^{(2)}$ | | +25°C | | 5 | μs | |
| $t_{(off)}$ | Amplifier turn-off time | | | +25°C | | 250 | ns | |
| | Gain-bandwidth product | $f = 10kHz$, $R_L = 600\Omega$ | | +25°C | | 2.8 | MHz | |
| t_s | Settling time | $V_{(STEP)PP} = 2V$, $A_V = -1$, $C_L = 10pF$, $R_L = 10k\Omega$ | | 0.1% | +25°C | | 1.5 | μs |
| | | | | 0.01% | | 3.9 | | |
| | | $V_{(STEP)PP} = 2V$, $A_V = -1$, $C_L = 56pF$, $R_L = 10k\Omega$ | | 0.1% | | 1.6 | | |
| | | | | 0.01% | | 4 | | |
| Φ_m | Phase margin | $R_L = 10k\Omega$, $C_L = 1000pF$ | | +25°C | | 61 | ° | |
| | Gain margin | $R_L = 10k\Omega$, $C_L = 1000pF$ | | +25°C | | 15 | dB | |

(1) Full range is 0°C to +70°C for C-suffix and –40°C to +125°C for I-suffix. If not specified, full range is –40°C to +125°C.

(2) Disable and enable time are defined as the interval between application of logic signal to \overline{SHDN} and the point at which the supply current has reached half its final value.

ELECTRICAL CHARACTERISTICS

At specified free-air temperature, $V_{DD} = 5V$, unless otherwise noted.

| PARAMETER | TEST CONDITIONS | T_A ⁽¹⁾ | MIN | TYP | MAX | UNIT |
|--|---|----------------------|------------|-----------|----------|------------------|
| V_{IO} Input offset voltage | | TLV247x | +25°C | 250 | 2200 | μV |
| | | | Full range | | 2400 | |
| | | TLV247xA | +25°C | 250 | 1600 | |
| | | | Full range | | 2000 | |
| α_{VIO} Temperature coefficient of input offset voltage | $V_{IC} = V_{DD}/2$, $V_O = V_{DD}/2$, $R_S = 50\Omega$ | | | 0.4 | | $\mu V/^\circ C$ |
| I_{IO} Input offset current | | +25°C | 1.7 | 50 | pA | |
| | | TLV247xC | Full range | | | 100 |
| | | TLV247xI | Full range | | | 300 |
| I_{IB} Input bias current | | +25°C | 2.5 | 50 | pA | |
| | | TLV247xC | Full range | | | 100 |
| | | TLV247xI | Full range | | | 300 |
| V_{OH} High-level output voltage | $V_{IC} = V_{DD}/2$ | $I_{OH} = -2.5mA$ | +25°C | 4.85 | 4.96 | V |
| | | | Full range | | 4.8 | |
| | | $I_{OH} = -10mA$ | +25°C | 4.72 | 4.82 | |
| | | | Full range | | 4.65 | |
| V_{OL} Low-level output voltage | $V_{IC} = V_{DD}/2$ | $I_{OL} = 2.5mA$ | +25°C | 0.07 | 0.15 | V |
| | | | Full range | | 0.2 | |
| | | $I_{OL} = 10mA$ | +25°C | 0.178 | 0.28 | |
| | | | Full range | | 0.35 | |
| I_{OS} Short-circuit output current | Sourcing | | +25°C | 110 | mA | |
| | | | Full range | | | 60 |
| | Sinking | | +25°C | 90 | | |
| | | | Full range | | | 60 |
| I_O Output current | $V_O = 0.5V$ from rail | | +25°C | ± 35 | mA | |
| A_{VD} Large-signal differential voltage amplification | $V_{O(PP)} = 3V$, $R_L = 10k\Omega$ | | +25°C | 92 | 120 | dB |
| | | | Full range | 91 | | |
| $r_{i(d)}$ Differential input resistance | | | +25°C | 10^{12} | Ω | |
| C_{IC} Common-mode input capacitance | $f = 10kHz$ | | +25°C | 18.9 | pF | |
| Z_o Closed-loop output impedance | $f = 10kHz$, $A_V = 10$ | | +25°C | 1.8 | Ω | |
| CMRR Common-mode rejection ratio | $V_{IC} = 0V$ to $5V$, $R_S = 50\Omega$ | | +25°C | 64 | 84 | dB |
| | | TLV247xC | Full range | 63 | | |
| | | TLV247xI | Full range | 58 | | |
| k_{SVR} Supply voltage rejection ratio ($\Delta V_{DD}/\Delta V_{IO}$) | $V_{DD} = 2.7V$ to $6V$, $V_{IC} = V_{DD}/2$, No load | | +25°C | 74 | 90 | dB |
| | | | Full range | 66 | | |
| | $V_{DD} = 3V$ to $5V$, $V_{IC} = V_{DD}/2$, No load | +25°C | 77 | 92 | | |
| | | Full range | 66 | | | |
| I_{DD} Supply current (per channel) | $V_O = 2.5V$, No load | | +25°C | 600 | 900 | μA |
| | | | Full range | | 1000 | |

(1) Full range is 0°C to +70°C for C-suffix and -40°C to +125°C for I-suffix. If not specified, full range is -40°C to +125°C.

ELECTRICAL CHARACTERISTICS (continued)

At specified free-air temperature, $V_{DD} = 5V$, unless otherwise noted.

| PARAMETER | | TEST CONDITIONS | $T_A^{(1)}$ | MIN | TYP | MAX | UNIT | |
|----------------|---|------------------------|-------------|------------|------|------|------|----|
| $I_{DD(SHDN)}$ | Supply current in shutdown mode (TLV2470, TLV2473, TLV2475) (per channel) | $\overline{SHDN} = 0V$ | +25°C | 1000 | 2500 | | nA | |
| | | | TLV247xC | Full range | | 3000 | | nA |
| | | | TLV247xI | Full range | | 6000 | | nA |

(1) Full range is 0°C to +70°C for C-suffix and –40°C to +125°C for I-suffix. If not specified, full range is –40°C to +125°C.

OPERATING CHARACTERISTICS

At specified free-air temperature, $V_{DD} = 5V$, unless otherwise noted.

| PARAMETER | | TEST CONDITIONS | $T_A^{(1)}$ | MIN | TYP | MAX | UNIT |
|-------------|--------------------------------------|---|-------------|-------|-------------|-------|-----------------|
| SR | Slew rate at unity gain | $V_{O(PP)} = 2V$, $C_L = 150pF$, $R_L = 10k\Omega$ | +25°C | 1.1 | 1.5 | | V/ μs |
| | | | Full range | 0.7 | | | |
| V_n | Equivalent input noise voltage | $f = 100Hz$ | +25°C | | 28 | | nV/ \sqrt{Hz} |
| | | $f = 1kHz$ | +25°C | | 15 | | |
| I_n | Equivalent input noise current | $f = 1kHz$ | +25°C | | 0.39 | | pA/ \sqrt{Hz} |
| THD + N | Total harmonic distortion plus noise | $V_{O(PP)} = 4V$, $R_L = 10k\Omega$, $f = 1kHz$ | +25°C | | $A_V = 1$ | 0.01% | |
| | | | | | $A_V = 10$ | 0.05% | |
| | | | | | $A_V = 100$ | 0.3% | |
| $t_{(on)}$ | Amplifier turn-on time | $R_L = OPEN^{(2)}$ | +25°C | | 5 | | μs |
| $t_{(off)}$ | Amplifier turn-off time | | +25°C | | 250 | | ns |
| | Gain-bandwidth product | $f = 10kHz$, $R_L = 600\Omega$ | +25°C | | 2.8 | | MHz |
| t_s | Settling time | $V_{(STEP)PP} = 2V$, $A_V = -1$, $C_L = 10pF$, $R_L = 10k\Omega$ | +25°C | 0.1% | 1.8 | | μs |
| | | | | 0.01% | 3.3 | | |
| | | $V_{(STEP)PP} = 2V$, $A_V = -1$, $C_L = 56pF$, $R_L = 10k\Omega$ | | 0.1% | 1.7 | | |
| | | | | 0.01% | 3 | | |
| Φ_m | Phase margin | $R_L = 10k\Omega$, $C_L = 1000pF$ | +25°C | | 68 | | ° |
| | Gain margin | $R_L = 10k\Omega$, $C_L = 1000pF$ | +25°C | | 23 | | dB |

(1) Full range is 0°C to +70°C for C suffix and –40°C to +125°C for I suffix. If not specified, full range is –40°C to +125°C.

(2) Disable and enable time are defined as the interval between application of logic signal to \overline{SHDN} and the point at which the supply current has reached half its final value.

TYPICAL CHARACTERISTICS

Table of Graphs

| | | | FIGURE |
|----------------|--|------------------------------|--------------------------------------|
| V_{IO} | Input offset voltage | vs Common-mode input voltage | Figure 1, Figure 2 |
| I_{IB} | Input bias current | vs Free-air temperature | Figure 3, Figure 4 |
| I_{IO} | Input offset current | | |
| V_{OH} | High-level output voltage | vs High-level output current | Figure 5, Figure 7 |
| V_{OL} | Low-level output voltage | vs Low-level output current | Figure 6, Figure 8 |
| Z_o | Output impedance | vs Frequency | Figure 9 |
| I_{DD} | Supply current | vs Supply voltage | Figure 10 |
| PSRR | Power-supply rejection ratio | vs Frequency | Figure 11 |
| CMRR | Common-mode rejection ratio | vs Frequency | Figure 12 |
| V_n | Equivalent input noise voltage | vs Frequency | Figure 13 |
| $V_{O(PP)}$ | Maximum peak-to-peak output voltage | vs Frequency | Figure 14, Figure 15 |
| A_{VD} | Differential voltage gain and phase | vs Frequency | Figure 16, Figure 17 |
| Φ_m | Phase margin | vs Load capacitance | Figure 18, Figure 19 |
| | Gain margin | vs Load capacitance | Figure 20, Figure 21 |
| | Gain-bandwidth product | vs Supply voltage | Figure 22 |
| SR | Slew rate | vs Supply voltage | Figure 23 |
| | | vs Free-air temperature | Figure 24, Figure 25 |
| | Crosstalk | vs Frequency | Figure 26 |
| THD+N | Total harmonic distortion + noise | vs Frequency | Figure 27, Figure 28 |
| V_o | Large and small signal follower | vs Time | Figure 29–Figure 32 |
| | Shutdown pulse response | vs Time | Figure 33, Figure 34 |
| | Shutdown forward and reverse isolation | vs Frequency | Figure 35, Figure 36 |
| $I_{DD(SHDN)}$ | Shutdown supply current | vs Supply voltage | Figure 37 |
| $I_{DD(SHDN)}$ | Shutdown supply current | vs Free-air temperature | Figure 38 |
| $I_{DD(SHDN)}$ | Shutdown pulse current | vs Time | Figure 39, Figure 40 |

TYPICAL CHARACTERISTICS

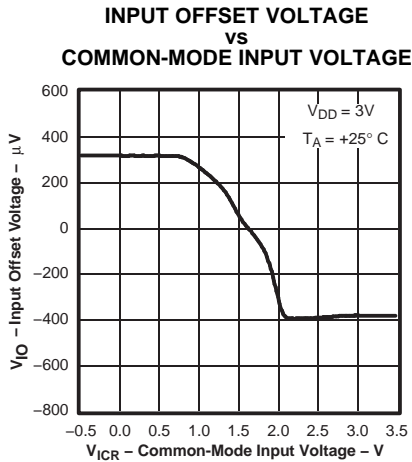

Figure 1.

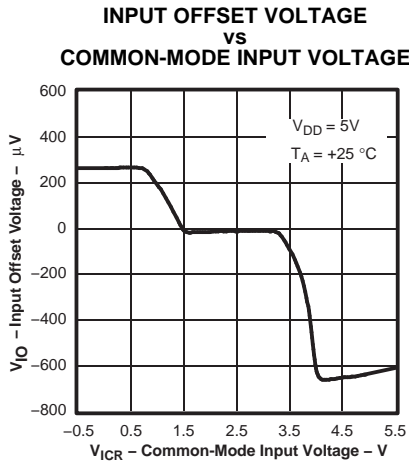

Figure 2.

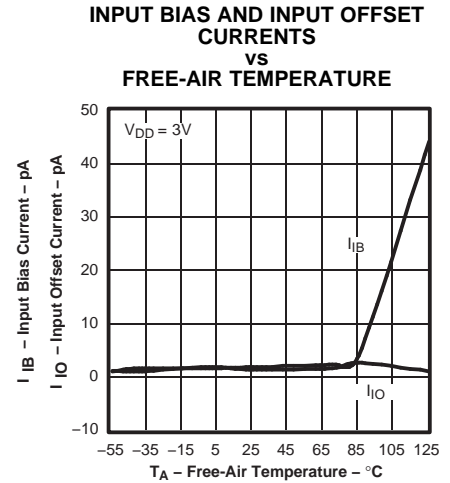

Figure 3.

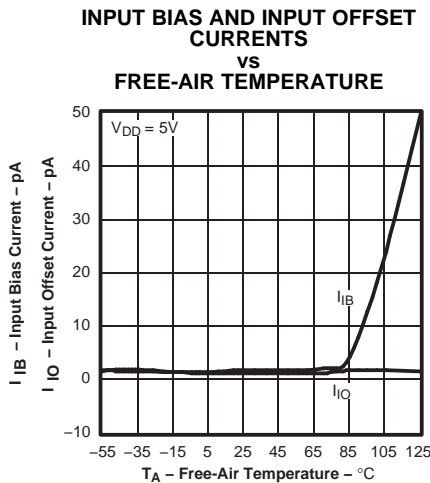

Figure 4.

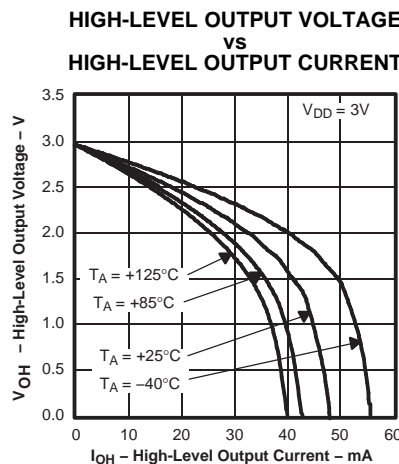

Figure 5.

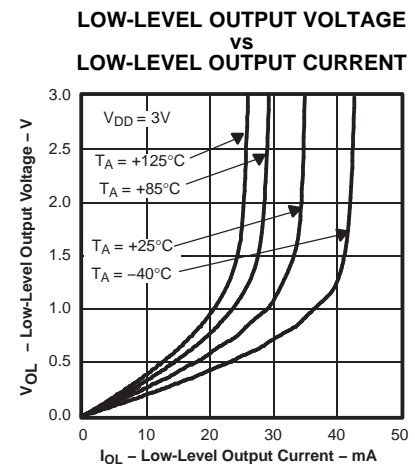

Figure 6.

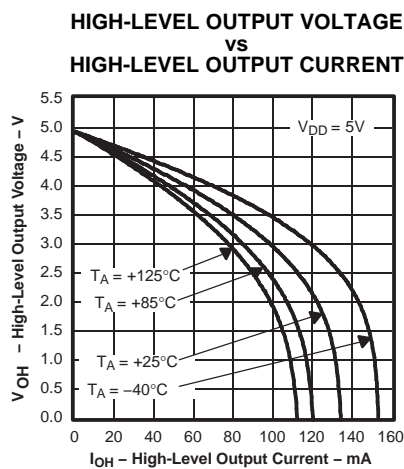

Figure 7.

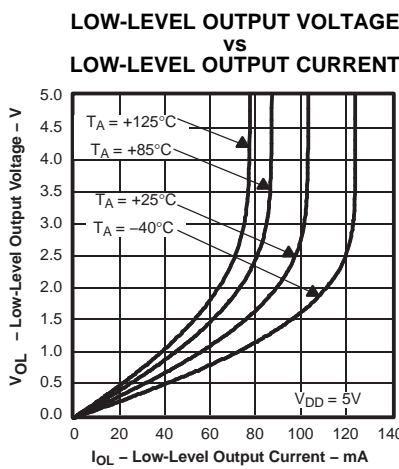

Figure 8.

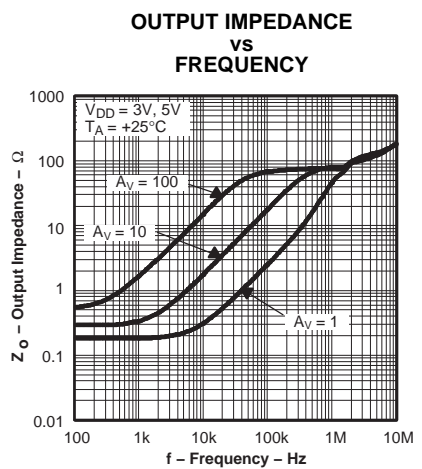

Figure 9.

TYPICAL CHARACTERISTICS (continued)

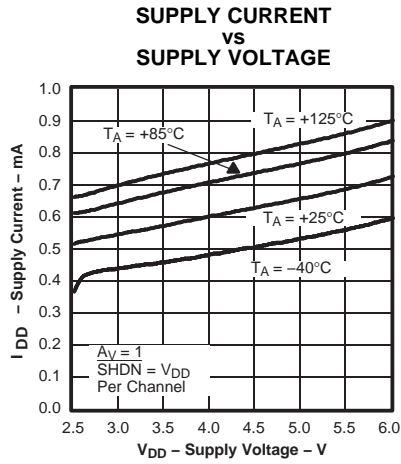

Figure 10.

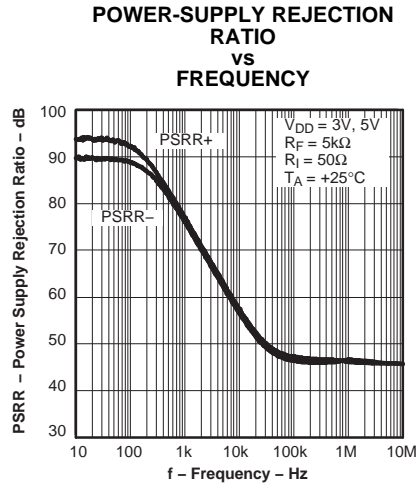

Figure 11.

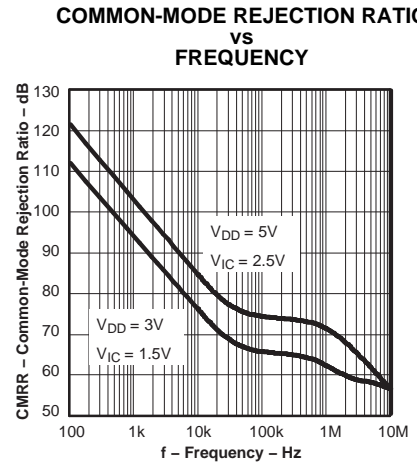

Figure 12.

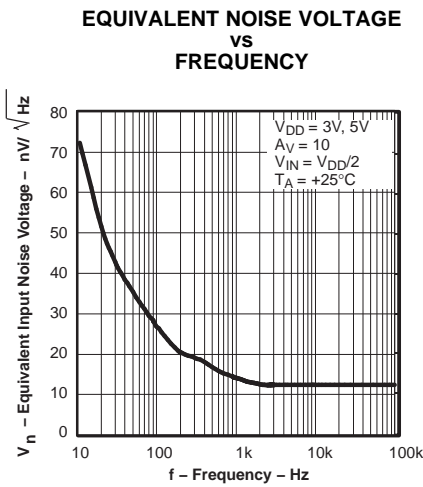

Figure 13.

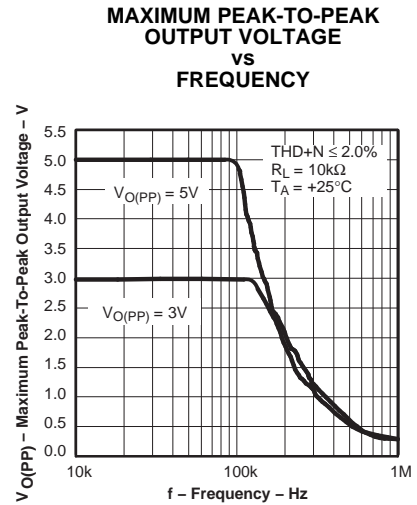

Figure 14.

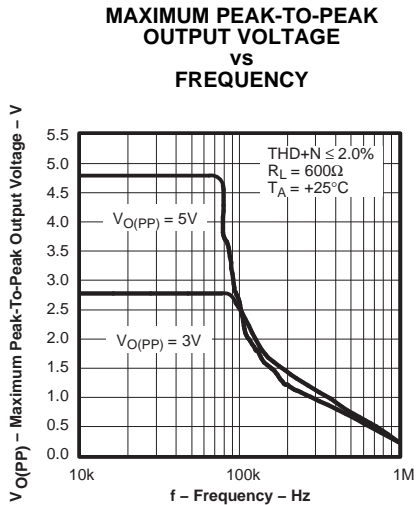

Figure 15.

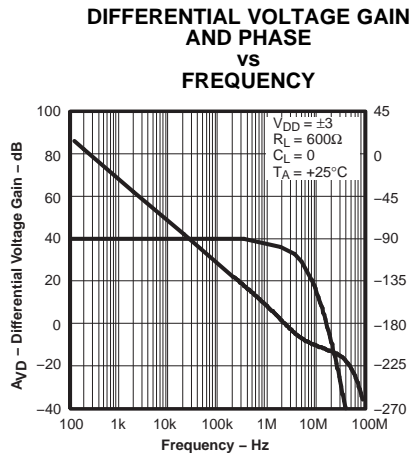

Figure 16.

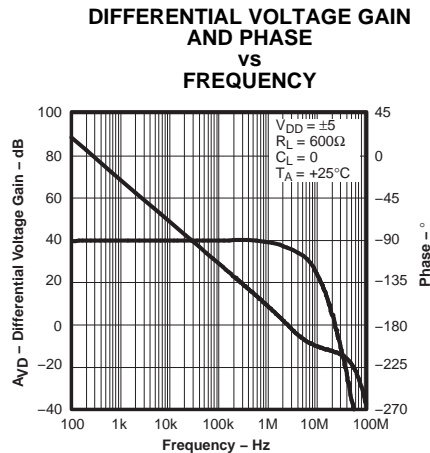

Figure 17.

TYPICAL CHARACTERISTICS (continued)

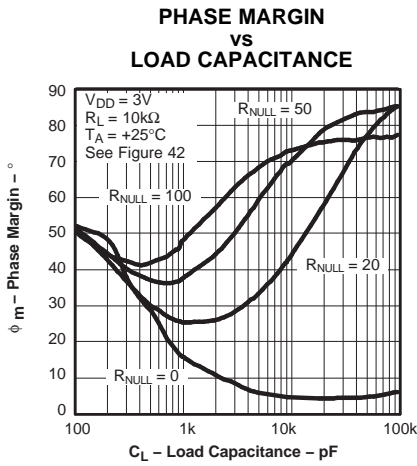

Figure 18.

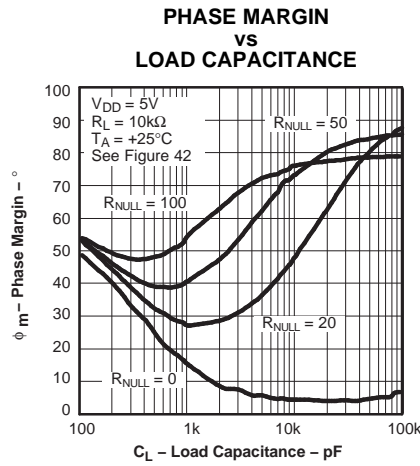

Figure 19.

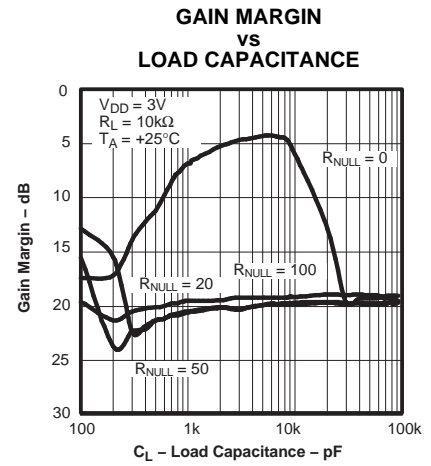

Figure 20.

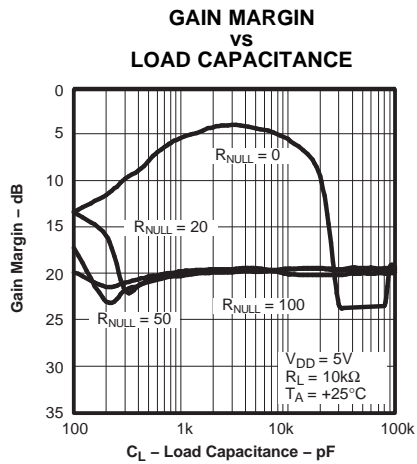

Figure 21.

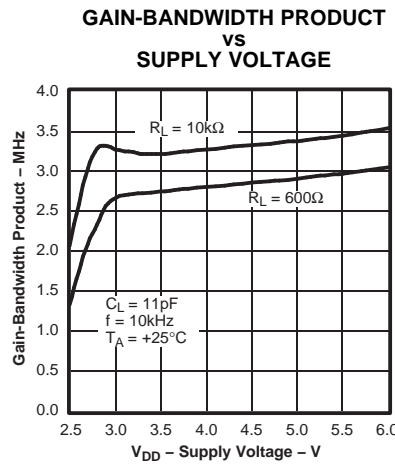

Figure 22.

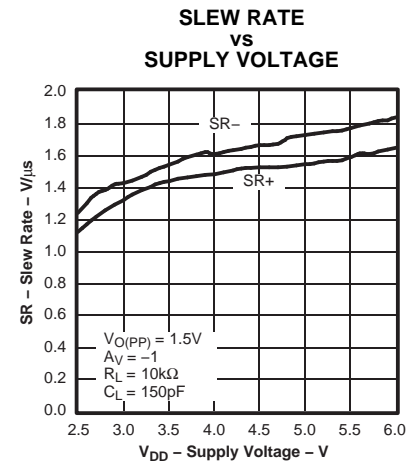

Figure 23.

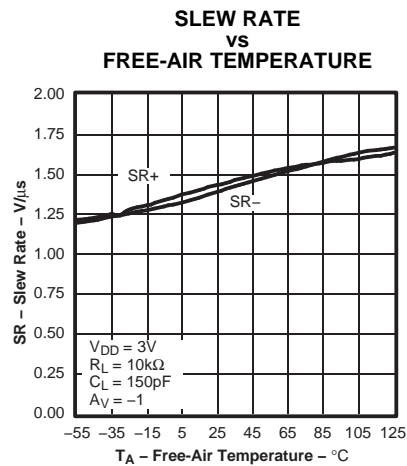

Figure 24.

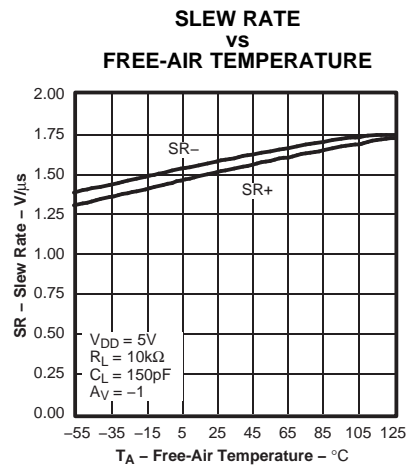

Figure 25.

TYPICAL CHARACTERISTICS (continued)

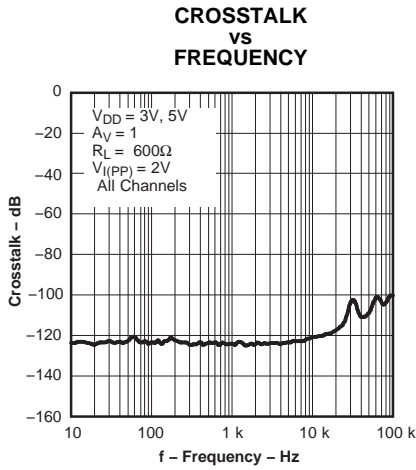

Figure 26.

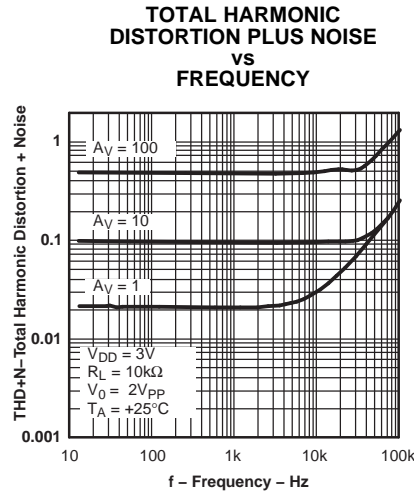

Figure 27.

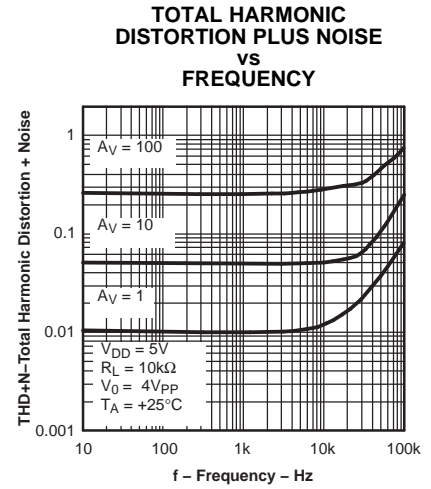

Figure 28.

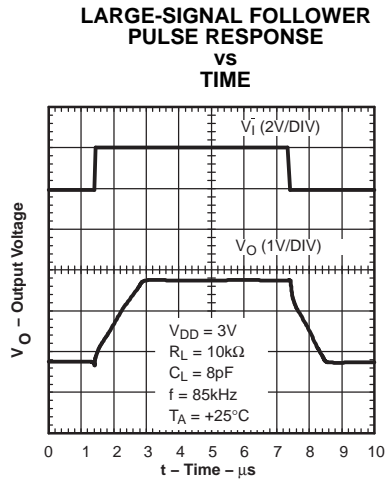

Figure 29.

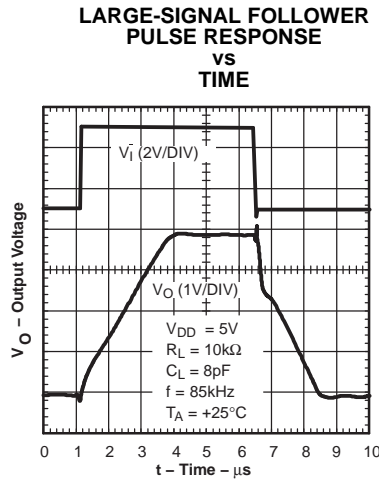

Figure 30.

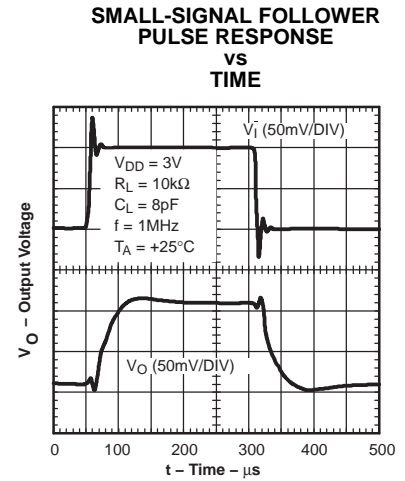

Figure 31.

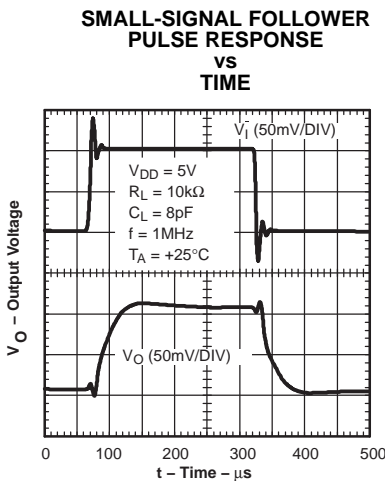

Figure 32.

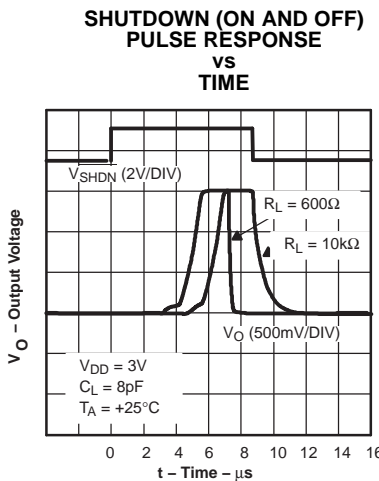

Figure 33.

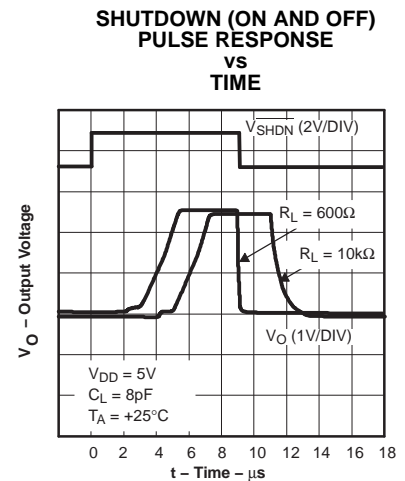

Figure 34.

TYPICAL CHARACTERISTICS (continued)

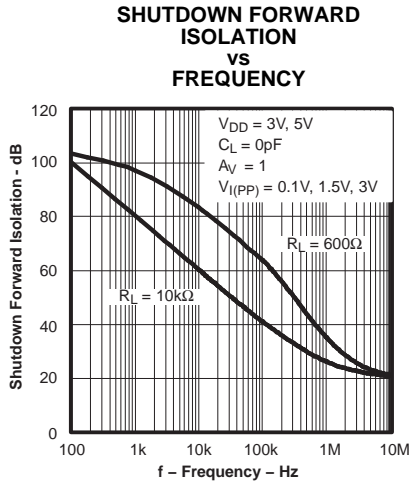

Figure 35.

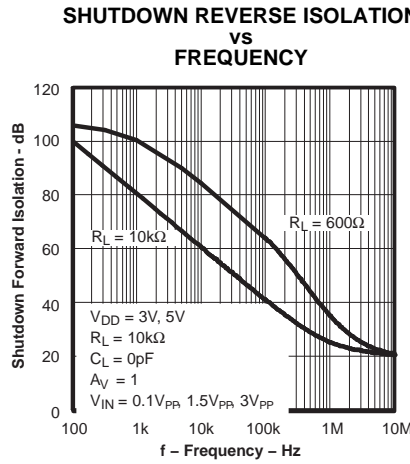

Figure 36.

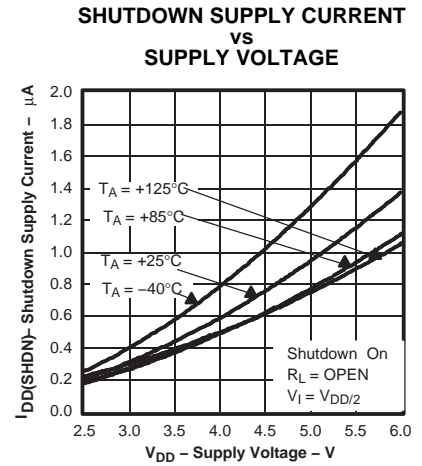

Figure 37.

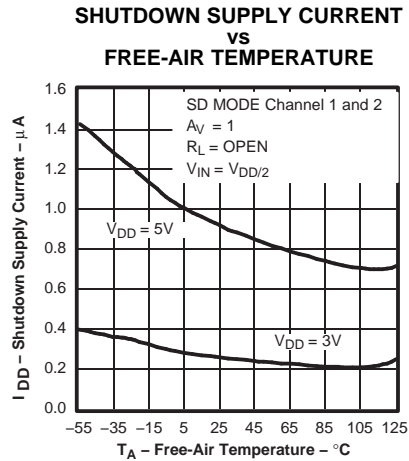

Figure 38.

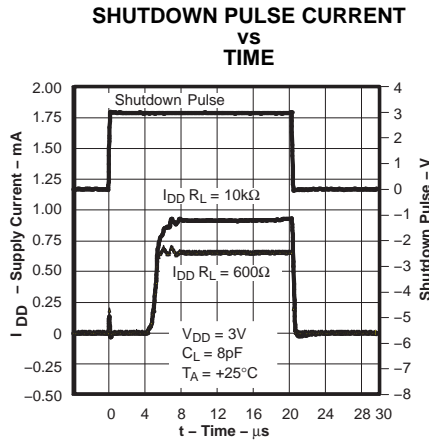

Figure 39.

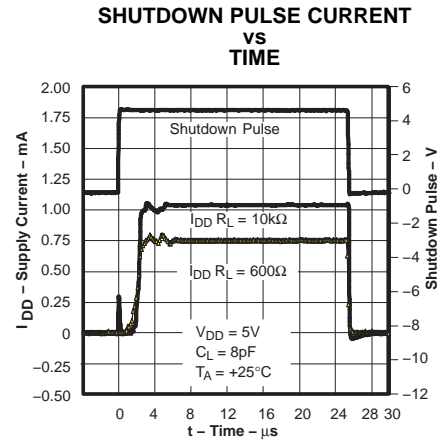

Figure 40.

PARAMETER MEASUREMENT INFORMATION

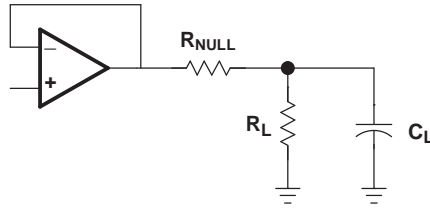

Figure 41.

APPLICATION INFORMATION

DRIVING A CAPACITIVE LOAD

When the amplifier is configured in this manner, capacitive loading directly on the output will decrease the device phase margin leading to high-frequency ringing or oscillations. Therefore, for capacitive loads of greater than 10pF, it is recommended that a resistor (R_{NULL}) be placed in series with the output of the amplifier, as shown in Figure 42. A minimum value of 20Ω should work well for most applications.

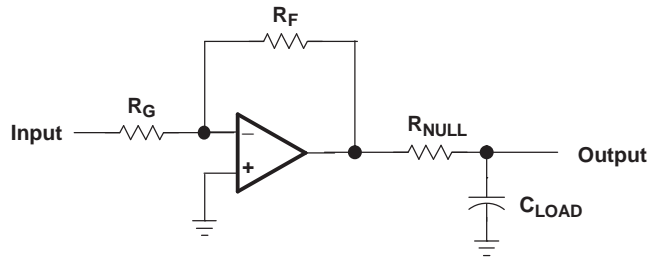
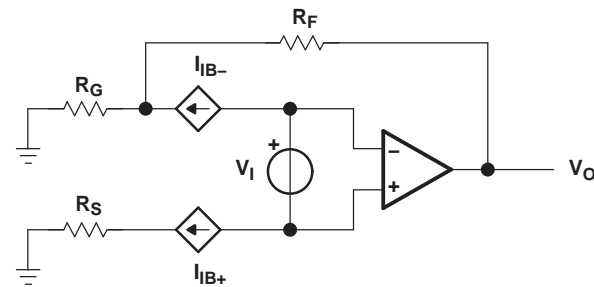

Figure 42. Driving a Capacitive Load

OFFSET VOLTAGE

The output offset voltage (V_{OO}) is the sum of the input offset voltage (V_{IO}) and both input bias currents (I_{IB}) times the corresponding gains. The following schematic and formula can be used to calculate the output offset voltage:



$$V_{OO} = V_{IO} \left(1 + \left(\frac{R_F}{R_G} \right) \right) \pm I_{IB+} R_S \left(1 + \left(\frac{R_F}{R_G} \right) \right) \pm I_{IB-} R_F$$

Figure 43. Output Offset Voltage Model

APPLICATION INFORMATION (continued)

GENERAL CONFIGURATIONS

When receiving low-level signals, limiting the bandwidth of the incoming signals into the system is often required. The simplest way to accomplish this is to place an RC filter at the noninverting terminal of the amplifier (see [Figure 44](#)).

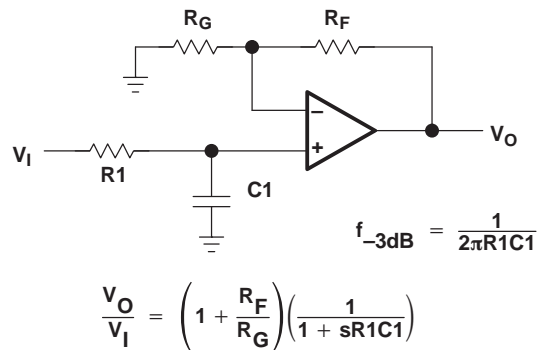

Figure 44. Single-Pole Low-Pass Filter

If even more attenuation is needed, a multiple pole filter is required. The Sallen-Key filter can be used for this task. For best results, the amplifier should have a bandwidth that is eight to ten times the filter frequency bandwidth. Failure to do this can result in phase shift of the amplifier.

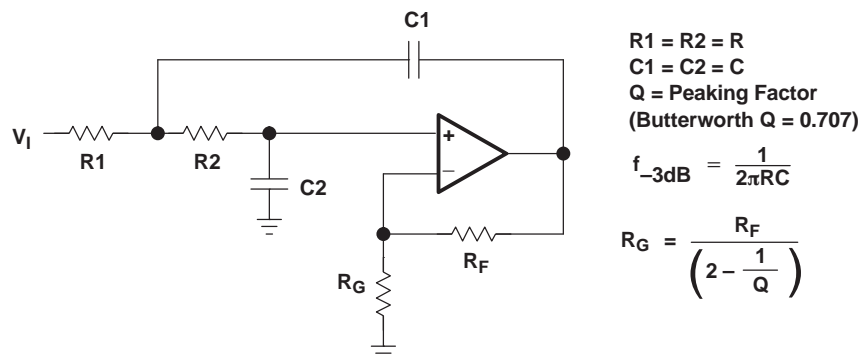

Figure 45. 2-Pole Low-Pass Sallen-Key Filter

SHUTDOWN FUNCTION

Three members of the TLV247x family (TLV2470/3/5) have a shutdown terminal for conserving battery life in portable applications. When the shutdown terminal is tied low, the supply current is reduced to 350nA/channel, the amplifier is disabled, and the outputs are placed in a high impedance mode. To enable the amplifier, the shutdown terminal can either be left floating or pulled high. When the shutdown terminal is left floating, care should be taken to ensure that parasitic leakage current at the shutdown terminal does not inadvertently place the operational amplifier into shutdown. The shutdown terminal threshold is always referenced to $V_{DD}/2$. Therefore, when operating the device with split supply voltages (e.g., $\pm 2.5V$), the shutdown terminal needs to be pulled to V_{DD-} (not GND) to disable the operational amplifier.

The amplifier output with a shutdown pulse is shown in [Figure 33](#) and [Figure 34](#). The amplifier is powered with a single 5V supply and configured as a noninverting configuration with a gain of 5. The amplifier turn-on and turn-off times are measured from the 50% point of the shutdown pulse to the 50% point of the output waveform. The times for the single, dual, and quad versions are listed in the data tables.

APPLICATION INFORMATION (continued)

Figure 35 and Figure 36 show the amplifier forward and reverse isolation in shutdown. The operational amplifier is powered by $\pm 1.35\text{V}$ supplies and configured as a voltage follower ($A_V = 1$). The isolation performance is plotted across frequency using 0.1V_{PP} , 1.5V_{PP} , and 2.5V_{PP} input signals. During normal operation, the amplifier would not be able to handle a 2.5V_{PP} input signal with a supply voltage of $\pm 1.35\text{V}$ since it exceeds the common-mode input voltage range (V_{ICR}). However, this curve illustrates that the amplifier remains in shutdown even under a worst case scenario.

CIRCUIT LAYOUT CONSIDERATIONS

To achieve the levels of high performance of the TLV247x, follow proper printed circuit board (PCB) design techniques. A general set of guidelines is given below:

- **Ground planes**—It is highly recommended that a ground plane be used on the board to provide all components with a low inductive ground connection. However, in the areas of the amplifier inputs and output, the ground plane can be removed to minimize the stray capacitance.
- **Proper power supply decoupling**—Use a $6.8\mu\text{F}$ tantalum capacitor in parallel with a $0.1\mu\text{F}$ ceramic capacitor on each supply terminal. It may be possible to share the tantalum among several amplifiers depending on the application, but a $0.1\mu\text{F}$ ceramic capacitor should always be used on the supply terminal of every amplifier. In addition, the $0.1\mu\text{F}$ capacitor should be placed as close as possible to the supply terminal. As this distance increases, the inductance in the connecting trace makes the capacitor less effective. The designer should strive for distances of less than 0.1 inches between the device power terminals and the ceramic capacitors.
- **Sockets**—Sockets can be used but are not recommended. The additional lead inductance in the socket pins will often lead to stability problems. Surface-mount packages soldered directly to the printed-circuit board is the best implementation.
- **Short trace runs/compact part placements**—Optimum high performance is achieved when stray series inductance has been minimized. To realize this, the circuit layout should be made as compact as possible, thereby minimizing the length of all trace runs. Particular attention should be paid to the inverting input of the amplifier. Its length should be kept as short as possible. This will help to minimize stray capacitance at the input of the amplifier.
- **Surface-mount passive components**—Using surface-mount passive components is recommended for high-performance amplifier circuits for several reasons. First, because of the extremely low lead inductance of surface-mount components, the problem with stray series inductance is greatly reduced. Second, the small size of surface-mount components naturally leads to a more compact layout thereby minimizing both stray inductance and capacitance. If leaded components are used, it is recommended that the lead lengths be kept as short as possible.

GENERAL PowerPAD™ DESIGN CONSIDERATIONS

The TLV247x is available in a thermally-enhanced PowerPAD family of packages. These packages are constructed using a downset leadframe upon which the die is mounted (see Figure 46a and Figure 46b). This arrangement results in the lead frame being exposed as a thermal pad on the underside of the package (see Figure 46c). Because this thermal pad has direct thermal contact with the die, excellent thermal performance can be achieved by providing a good thermal path away from the thermal pad.

The PowerPAD package allows for both assembly and thermal management in one manufacturing operation. During the surface-mount solder operation (when the leads are being soldered), the thermal pad must be soldered to a copper area underneath the package. Through the use of thermal paths within this copper area, heat can be conducted away from the package into either a ground plane or other heat dissipating device.

Soldering the PowerPAD to the PCB is always recommended, even with applications that have low power dissipation. It provides the necessary mechanical and thermal connection between the lead frame die pad and the PCB.

The PowerPAD package represents a breakthrough in combining the small area and ease of assembly of surface mount with previously awkward mechanical methods of heatsinking.

APPLICATION INFORMATION (continued)

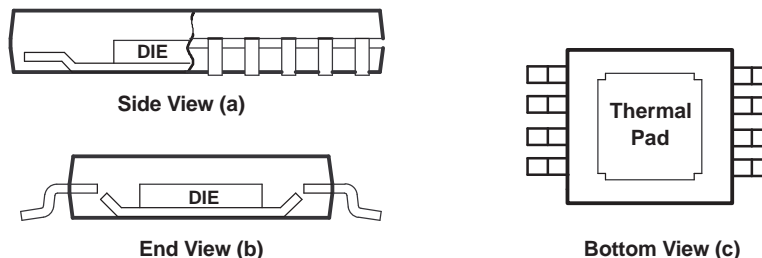

The thermal pad is electrically isolated from all terminals in the package.

Figure 46. Views of Thermally Enhanced DGN Package

Although there are many ways to properly heatsink the PowerPAD package, the following steps illustrate the recommended approach.

1. The thermal pad must be connected to the most negative supply voltage on the device (GND pin).
2. Prepare the PCB with a top side etch pattern as illustrated in the thermal land pattern mechanical drawing at the end of this document. There should be etch for the leads as well as etch for the thermal pad.
3. Place holes in the area of the thermal pad as illustrated in the land pattern mechanical drawing at the end of this document. These holes should be 13mils (0.013 inches or 0.3302mm) in diameter. Keep them small so that solder wicking through the holes is not a problem during reflow.
4. Additional vias may be placed anywhere along the thermal plane outside of the thermal pad area. This helps dissipate the heat generated by the TLV247x IC. These additional vias may be larger than the 13mil diameter vias directly under the thermal pad. They can be larger because they are not in the thermal pad area to be soldered so that wicking is not a problem.
5. Connect all holes to the internal ground plane that is at the same voltage potential as the device GND pin.
6. When connecting these holes to the ground plane, **do not** use the typical web or spoke via connection methodology. Web connections have a high thermal resistance connection that is useful for slowing the heat transfer during soldering operations. This makes the soldering of vias that have plane connections easier. In this application, however, low thermal resistance is desired for the most efficient heat transfer. Therefore, the holes under the TLV247x PowerPAD package should make their connection to the internal ground plane with a complete connection around the entire circumference of the plated-through hole.
7. The top-side solder mask should leave the terminals of the package and the thermal pad area with its holes exposed. The bottom-side solder mask should cover the holes of the thermal pad area. This prevents solder from being pulled away from the thermal pad area during the reflow process.
8. Apply solder paste to the exposed thermal pad area and all of the IC terminals.
9. With these preparatory steps in place, the TLV247x IC is simply placed in position and run through the solder reflow operation as any standard surface-mount component. This results in a part that is properly installed.

For a given θ_{JA} , the maximum power dissipation is shown in [Figure 47](#) and is calculated by [Equation 1](#):

$$P_D = \left(\frac{T_{MAX} - T_A}{\theta_{JA}} \right) \quad (1)$$

Where:

- P_D = Maximum power dissipation of TLV247x IC (watts)
- T_{MAX} = Absolute maximum junction temperature (+150°C)
- T_A = Free-ambient air temperature (°C)
- $\theta_{JA} = \theta_{JC} + \theta_{CA}$
 - θ_{JC} = Thermal coefficient from junction to case
 - θ_{CA} = Thermal coefficient from case to ambient air (°C/W)

APPLICATION INFORMATION (continued)

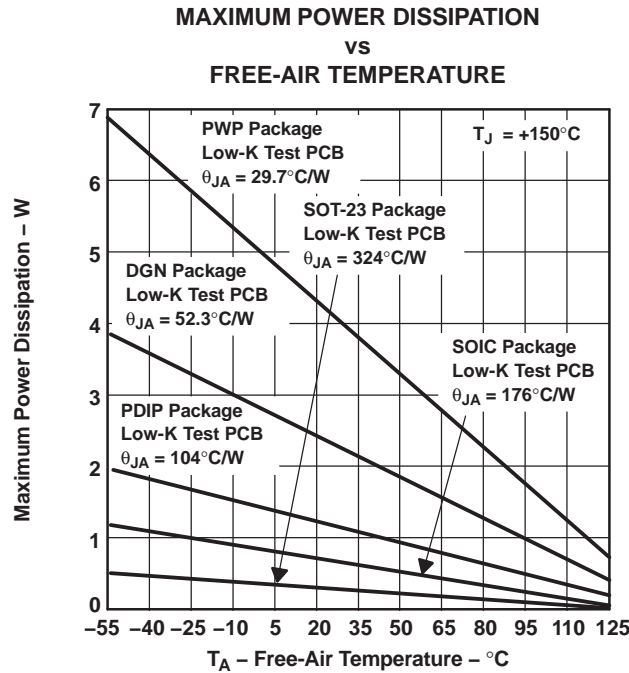

Results are obtained with no air flow and using JEDEC Standard Low-K test PCB.

Figure 47. Maximum Power Dissipation vs Free-Air Temperature

The next consideration is the package constraints. The two sources of heat within an amplifier are quiescent power and output power. The designer should never forget about the quiescent heat generated within the device, especially multi-amplifier devices. Because these devices have linear output stages (Class A-B), most of the heat dissipation is at low output voltages with high output currents. Figure 48 to Figure 53 show this effect, along with the quiescent heat, with an ambient air temperature of +70°C and +125°C. When using $V_{DD} = 3V$, there is generally not a heat problem with an ambient air temperature of +70°C. But, when using $V_{DD} = 5V$, the package is severely limited in the amount of heat it can dissipate. The other key factor when looking at these graphs is how the devices are mounted on the PCB. The PowerPAD devices are extremely useful for heat dissipation. But the device should always be soldered to a copper plane to fully use the heat dissipation properties of the PowerPAD. The SOIC package, on the other hand, is highly dependent on how it is mounted on the PCB. As more trace and copper area is placed around the device, θ_{JA} decreases and the heat dissipation capability increases. The currents and voltages shown in these graphs are for the total package. For the dual or quad amplifier packages, the sum of the RMS output currents and voltages should be used to choose the proper package.

APPLICATION INFORMATION (continued)

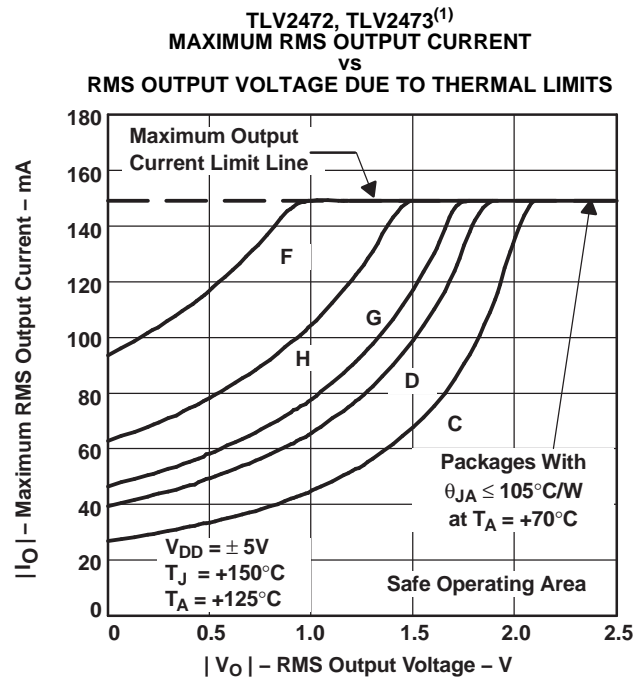
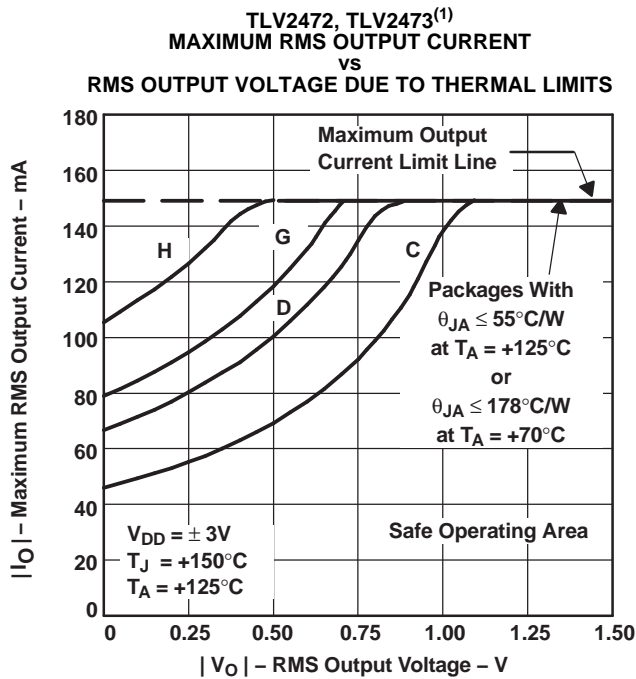
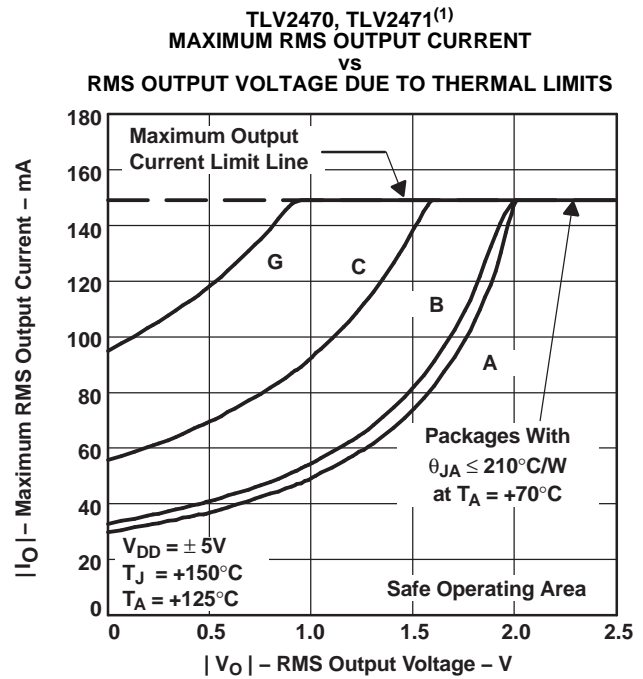
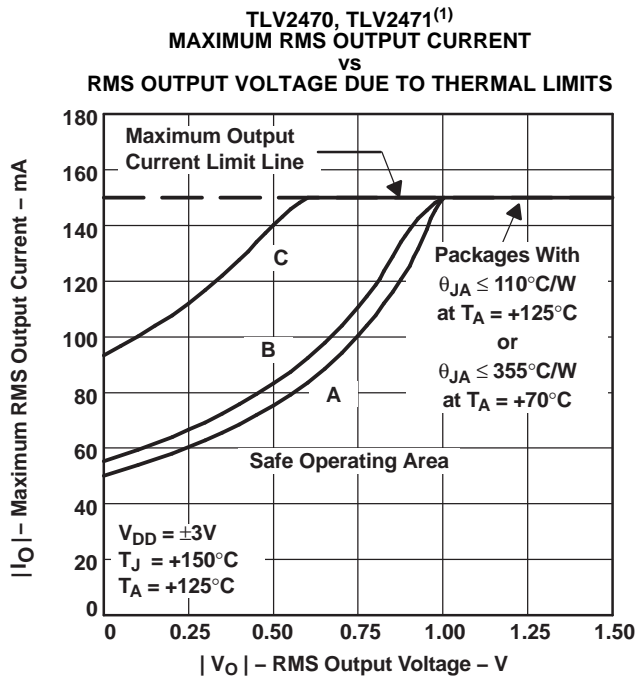

Note: (1) A - SOT23 (5); B - SOT23 (6); C - SOIC (8); D - SOIC (14); E - SOIC (16); F - MSOP PP (8); G - PDIP (8); H - PDIP (14); I - PDIP (16); J - TSSOP PP (14/16)

APPLICATION INFORMATION (continued)

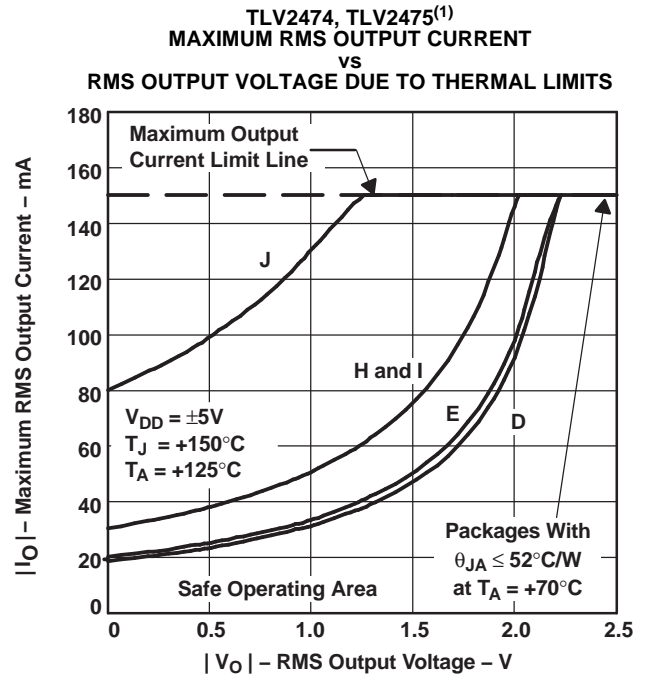
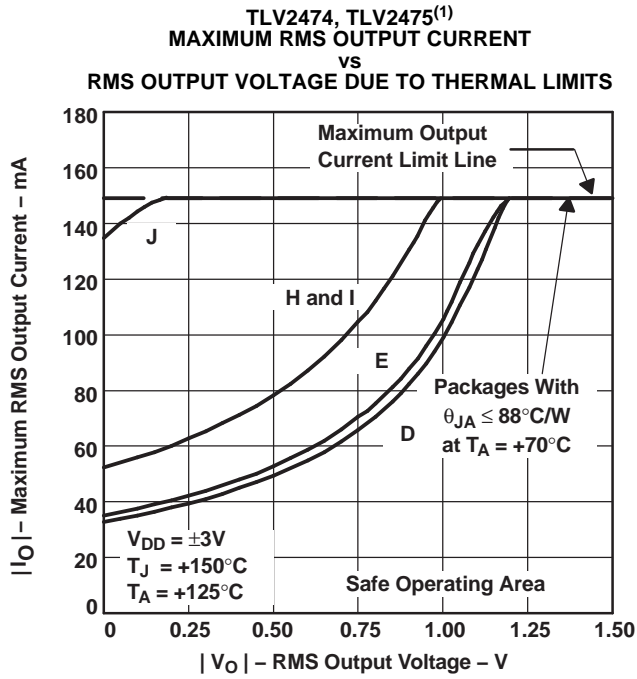

NOTE: (1) A - SOT23 (5); B - SOT23 (6); C - SOIC (8); D - SOIC (14); E - SOIC (16); F - MSOP PP (8); G - PDIP (8); H - PDIP (14); I - PDIP (16); J - TSSOP PP (14/16)

APPLICATION INFORMATION (continued)

MACROMODEL INFORMATION

Macromodel information provided was derived using Microsim PARTS™, the model generation software used with Microsim PSpice®. The Boyle macromodel and subcircuit in Figure 54 are generated using the TLV247x typical electrical and operating characteristics at T_A = 25°C. Using this information, output simulations of the following key parameters can be generated to a tolerance of 20% (in most cases):

- Maximum positive output voltage swing
- Maximum negative output voltage swing
- Slew rate
- Quiescent power dissipation
- Input bias current
- Open-loop voltage amplification
- Unity-gain frequency
- Common-mode rejection ratio
- Phase margin
- DC output resistance
- AC output resistance
- Short-circuit output current limit

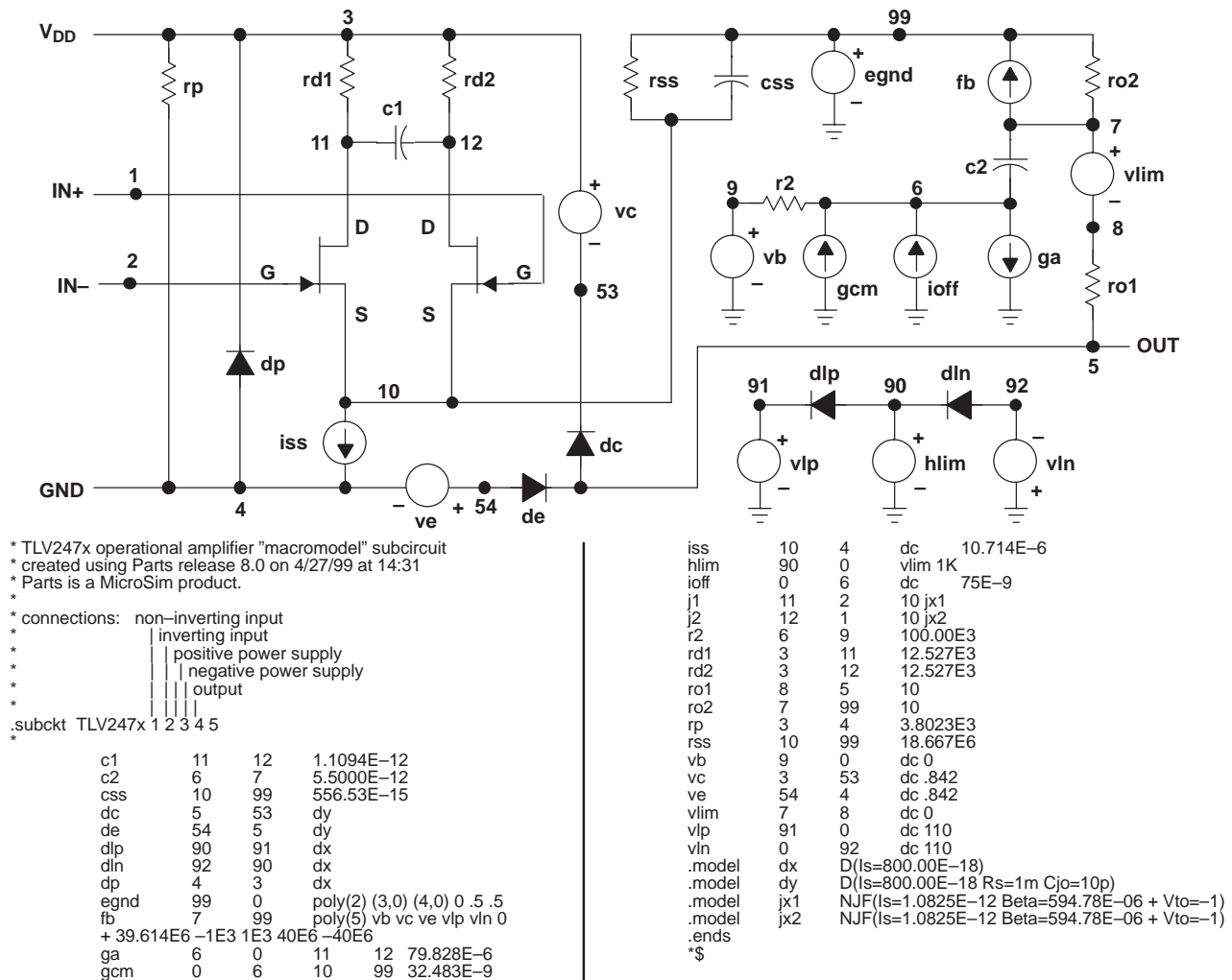

G. R. Boyle, B. M. Cohn, D. O. Pederson, and J. E. Solomon, "Macromodeling of Integrated Circuit Operational Amplifiers," *IEEE Journal of Solid-State Circuits*, SC-9, 353 (1974).

Figure 54. Boyle Macromodel and Subcircuit

PACKAGING INFORMATION

| Orderable Device | Status (1) | Package Type | Package Drawing | Pins | Package Qty | Eco Plan (2) | Lead finish/ Ball material (6) | MSL Peak Temp (3) | Op Temp (°C) | Device Marking (4/5) | Samples |
|------------------|---------------|--------------|-----------------|------|-------------|-----------------|--------------------------------------|----------------------|--------------|-------------------------|-------------------------|
| TLV2470AID | ACTIVE | SOIC | D | 8 | 75 | RoHS & Green | NIPDAU | Level-1-260C-UNLIM | -40 to 125 | 2470AI | Samples |
| TLV2470AIP | ACTIVE | PDIP | P | 8 | 50 | RoHS & Green | NIPDAU | N / A for Pkg Type | -40 to 125 | TLV2470AI | Samples |
| TLV2470CD | ACTIVE | SOIC | D | 8 | 75 | RoHS & Green | NIPDAU | Level-1-260C-UNLIM | 0 to 70 | 2470C | Samples |
| TLV2470CDBVR | ACTIVE | SOT-23 | DBV | 6 | 3000 | RoHS & Green | NIPDAU | Level-1-260C-UNLIM | 0 to 70 | VAUC | Samples |
| TLV2470CDBVT | ACTIVE | SOT-23 | DBV | 6 | 250 | RoHS & Green | NIPDAU | Level-1-260C-UNLIM | 0 to 70 | VAUC | Samples |
| TLV2470CDR | ACTIVE | SOIC | D | 8 | 2500 | RoHS & Green | NIPDAU | Level-1-260C-UNLIM | 0 to 70 | 2470C | Samples |
| TLV2470CP | ACTIVE | PDIP | P | 8 | 50 | RoHS & Green | NIPDAU | N / A for Pkg Type | 0 to 70 | TLV2470C | Samples |
| TLV2470ID | ACTIVE | SOIC | D | 8 | 75 | RoHS & Green | NIPDAU | Level-1-260C-UNLIM | -40 to 125 | 2470I | Samples |
| TLV2470IDBVR | ACTIVE | SOT-23 | DBV | 6 | 3000 | RoHS & Green | NIPDAU | Level-1-260C-UNLIM | -40 to 125 | VAUI | Samples |
| TLV2470IDBVT | ACTIVE | SOT-23 | DBV | 6 | 250 | RoHS & Green | NIPDAU | Level-1-260C-UNLIM | -40 to 125 | VAUI | Samples |
| TLV2470IDR | ACTIVE | SOIC | D | 8 | 2500 | RoHS & Green | NIPDAU | Level-1-260C-UNLIM | -40 to 125 | 2470I | Samples |
| TLV2471AID | ACTIVE | SOIC | D | 8 | 75 | RoHS & Green | NIPDAU | Level-1-260C-UNLIM | -40 to 125 | 2471AI | Samples |
| TLV2471AIDR | ACTIVE | SOIC | D | 8 | 2500 | RoHS & Green | NIPDAU | Level-1-260C-UNLIM | -40 to 125 | 2471AI | Samples |
| TLV2471AIP | ACTIVE | PDIP | P | 8 | 50 | RoHS & Green | NIPDAU | N / A for Pkg Type | -40 to 125 | TLV2471AI | Samples |
| TLV2471CD | ACTIVE | SOIC | D | 8 | 75 | RoHS & Green | NIPDAU | Level-1-260C-UNLIM | 0 to 70 | 2471C | Samples |
| TLV2471CDBVR | ACTIVE | SOT-23 | DBV | 5 | 3000 | RoHS & Green | NIPDAU SN | Level-1-260C-UNLIM | 0 to 70 | VAVC | Samples |
| TLV2471CDBVT | ACTIVE | SOT-23 | DBV | 5 | 250 | RoHS & Green | NIPDAU SN | Level-1-260C-UNLIM | 0 to 70 | VAVC | Samples |
| TLV2471CDBVTG4 | ACTIVE | SOT-23 | DBV | 5 | 250 | TBD | Call TI | Call TI | 0 to 70 | | Samples |
| TLV2471CDR | ACTIVE | SOIC | D | 8 | 2500 | RoHS & Green | NIPDAU | Level-1-260C-UNLIM | 0 to 70 | 2471C | Samples |
| TLV2471CP | ACTIVE | PDIP | P | 8 | 50 | RoHS & Green | NIPDAU | N / A for Pkg Type | 0 to 70 | TLV2471C | Samples |

| Orderable Device | Status (1) | Package Type | Package Drawing | Pins | Package Qty | Eco Plan (2) | Lead finish/ Ball material (6) | MSL Peak Temp (3) | Op Temp (°C) | Device Marking (4/5) | Samples |
|------------------|---------------|--------------|-----------------|------|-------------|-----------------|--------------------------------------|----------------------|--------------|-------------------------|-------------------------|
| TLV2471ID | ACTIVE | SOIC | D | 8 | 75 | RoHS & Green | NIPDAU | Level-1-260C-UNLIM | -40 to 125 | 2471I | Samples |
| TLV2471IDBVR | ACTIVE | SOT-23 | DBV | 5 | 3000 | RoHS & Green | NIPDAU SN | Level-1-260C-UNLIM | -40 to 125 | VAVI | Samples |
| TLV2471IDBVRG4 | ACTIVE | SOT-23 | DBV | 5 | 3000 | TBD | Call TI | Call TI | -40 to 125 | | Samples |
| TLV2471IDBVT | ACTIVE | SOT-23 | DBV | 5 | 250 | RoHS & Green | NIPDAU SN | Level-1-260C-UNLIM | -40 to 125 | VAVI | Samples |
| TLV2471IDBVTG4 | ACTIVE | SOT-23 | DBV | 5 | 250 | TBD | Call TI | Call TI | -40 to 125 | | Samples |
| TLV2471IDR | ACTIVE | SOIC | D | 8 | 2500 | RoHS & Green | NIPDAU | Level-1-260C-UNLIM | -40 to 125 | 2471I | Samples |
| TLV2471IP | ACTIVE | PDIP | P | 8 | 50 | RoHS & Green | NIPDAU | N / A for Pkg Type | -40 to 125 | TLV2471I | Samples |
| TLV2472AID | ACTIVE | SOIC | D | 8 | 75 | RoHS & Green | NIPDAU | Level-1-260C-UNLIM | -40 to 125 | 2472AI | Samples |
| TLV2472AIDG4 | ACTIVE | SOIC | D | 8 | 75 | TBD | Call TI | Call TI | -40 to 125 | | Samples |
| TLV2472AIDR | ACTIVE | SOIC | D | 8 | 2500 | RoHS & Green | NIPDAU | Level-1-260C-UNLIM | -40 to 125 | 2472AI | Samples |
| TLV2472AIP | ACTIVE | PDIP | P | 8 | 50 | RoHS & Green | NIPDAU | N / A for Pkg Type | -40 to 125 | TLV2472AI | Samples |
| TLV2472CD | ACTIVE | SOIC | D | 8 | 75 | RoHS & Green | NIPDAU | Level-1-260C-UNLIM | 0 to 70 | 2472C | Samples |
| TLV2472CDGN | ACTIVE | HVSSOP | DGN | 8 | 80 | RoHS & Green | NIPDAU | Level-1-260C-UNLIM | 0 to 70 | ABU | Samples |
| TLV2472CDGNR | ACTIVE | HVSSOP | DGN | 8 | 2500 | RoHS & Green | NIPDAU | Level-1-260C-UNLIM | 0 to 70 | ABU | Samples |
| TLV2472CDR | ACTIVE | SOIC | D | 8 | 2500 | RoHS & Green | NIPDAU | Level-1-260C-UNLIM | 0 to 70 | 2472C | Samples |
| TLV2472CP | ACTIVE | PDIP | P | 8 | 50 | RoHS & Green | NIPDAU | N / A for Pkg Type | 0 to 70 | TLV2472CP | Samples |
| TLV2472ID | ACTIVE | SOIC | D | 8 | 75 | RoHS & Green | NIPDAU | Level-1-260C-UNLIM | -40 to 125 | 2472I | Samples |
| TLV2472IDGN | ACTIVE | HVSSOP | DGN | 8 | 80 | RoHS & Green | NIPDAU | Level-1-260C-UNLIM | -40 to 125 | ABV | Samples |
| TLV2472IDGNG4 | ACTIVE | HVSSOP | DGN | 8 | 80 | TBD | Call TI | Call TI | -40 to 125 | | Samples |
| TLV2472IDGNR | ACTIVE | HVSSOP | DGN | 8 | 2500 | RoHS & Green | NIPDAU | Level-1-260C-UNLIM | -40 to 125 | ABV | Samples |
| TLV2472IDR | ACTIVE | SOIC | D | 8 | 2500 | RoHS & Green | NIPDAU | Level-1-260C-UNLIM | -40 to 125 | 2472I | Samples |

| Orderable Device | Status (1) | Package Type | Package Drawing | Pins | Package Qty | Eco Plan (2) | Lead finish/ Ball material (6) | MSL Peak Temp (3) | Op Temp (°C) | Device Marking (4/5) | Samples |
|------------------|---------------|--------------|-----------------|------|-------------|-----------------|--------------------------------------|----------------------|--------------|-------------------------|-------------------------|
| TLV2472IP | ACTIVE | PDIP | P | 8 | 50 | RoHS & Green | NIPDAU | N / A for Pkg Type | -40 to 125 | TLV2472IP | Samples |
| TLV2473AIDR | ACTIVE | SOIC | D | 14 | 2500 | RoHS & Green | NIPDAU | Level-1-260C-UNLIM | -40 to 125 | TLV2473AI | Samples |
| TLV2473AIN | ACTIVE | PDIP | N | 14 | 25 | RoHS & Green | NIPDAU | N / A for Pkg Type | -40 to 125 | TLV2473AIN | Samples |
| TLV2473CD | ACTIVE | SOIC | D | 14 | 50 | RoHS & Green | NIPDAU | Level-1-260C-UNLIM | 0 to 70 | TLV2473C | Samples |
| TLV2473CDGQR | ACTIVE | HVSSOP | DGQ | 10 | 2500 | RoHS & Green | NIPDAU NIPDAUAG | Level-1-260C-UNLIM | 0 to 70 | ABW | Samples |
| TLV2473CDR | ACTIVE | SOIC | D | 14 | 2500 | RoHS & Green | NIPDAU | Level-1-260C-UNLIM | 0 to 70 | TLV2473C | Samples |
| TLV2473IDGQR | ACTIVE | HVSSOP | DGQ | 10 | 2500 | RoHS & Green | NIPDAU | Level-1-260C-UNLIM | -40 to 125 | ABX | Samples |
| TLV2473IN | ACTIVE | PDIP | N | 14 | 25 | RoHS & Green | NIPDAU | N / A for Pkg Type | -40 to 125 | TLV2473IN | Samples |
| TLV2474AID | ACTIVE | SOIC | D | 14 | 50 | RoHS & Green | NIPDAU | Level-1-260C-UNLIM | -40 to 125 | 2474AI | Samples |
| TLV2474AIDR | ACTIVE | SOIC | D | 14 | 2500 | RoHS & Green | NIPDAU | Level-1-260C-UNLIM | -40 to 125 | 2474AI | Samples |
| TLV2474AIN | ACTIVE | PDIP | N | 14 | 25 | RoHS & Green | NIPDAU | N / A for Pkg Type | -40 to 125 | TLV2474AI | Samples |
| TLV2474AIPWP | ACTIVE | HTSSOP | PWP | 14 | 90 | RoHS & Green | NIPDAU | Level-2-260C-1 YEAR | -40 to 125 | 2474AI | Samples |
| TLV2474AIPWPR | ACTIVE | HTSSOP | PWP | 14 | 2000 | RoHS & Green | NIPDAU | Level-2-260C-1 YEAR | -40 to 125 | 2474AI | Samples |
| TLV2474AIPWR | ACTIVE | TSSOP | PW | 14 | 2000 | RoHS & Green | NIPDAU | Level-1-260C-UNLIM | -40 to 125 | 2474AI | Samples |
| TLV2474CD | ACTIVE | SOIC | D | 14 | 50 | RoHS & Green | NIPDAU | Level-1-260C-UNLIM | 0 to 70 | 2474C | Samples |
| TLV2474CDR | ACTIVE | SOIC | D | 14 | 2500 | RoHS & Green | NIPDAU | Level-1-260C-UNLIM | 0 to 70 | 2474C | Samples |
| TLV2474CN | ACTIVE | PDIP | N | 14 | 25 | RoHS & Green | NIPDAU | N / A for Pkg Type | 0 to 70 | TLV2474C | Samples |
| TLV2474CPWP | ACTIVE | HTSSOP | PWP | 14 | 90 | RoHS & Green | NIPDAU | Level-2-260C-1 YEAR | 0 to 70 | 2474C | Samples |
| TLV2474CPWPR | ACTIVE | HTSSOP | PWP | 14 | 2000 | RoHS & Green | NIPDAU | Level-2-260C-1 YEAR | 0 to 70 | 2474C | Samples |
| TLV2474ID | ACTIVE | SOIC | D | 14 | 50 | RoHS & Green | NIPDAU | Level-1-260C-UNLIM | -40 to 125 | 2474I | Samples |
| TLV2474IDR | ACTIVE | SOIC | D | 14 | 2500 | RoHS & Green | NIPDAU | Level-1-260C-UNLIM | -40 to 125 | 2474I | Samples |

| Orderable Device | Status (1) | Package Type | Package Drawing | Pins | Package Qty | Eco Plan (2) | Lead finish/ Ball material (6) | MSL Peak Temp (3) | Op Temp (°C) | Device Marking (4/5) | Samples |
|------------------|---------------|--------------|-----------------|------|-------------|-----------------|--------------------------------------|----------------------|--------------|-------------------------|-------------------------|
| TLV2474IN | ACTIVE | PDIP | N | 14 | 25 | RoHS & Green | NIPDAU | N / A for Pkg Type | -40 to 125 | TLV2474I | Samples |
| TLV2474IPWP | ACTIVE | HTSSOP | PWP | 14 | 90 | RoHS & Green | NIPDAU | Level-2-260C-1 YEAR | -40 to 125 | 2474I | Samples |
| TLV2474IPWPR | ACTIVE | HTSSOP | PWP | 14 | 2000 | RoHS & Green | NIPDAU | Level-2-260C-1 YEAR | -40 to 125 | 2474I | Samples |
| TLV2475AIDR | ACTIVE | SOIC | D | 16 | 2500 | RoHS & Green | NIPDAU | Level-1-260C-UNLIM | -40 to 125 | TLV2475AI | Samples |
| TLV2475AIPWP | ACTIVE | HTSSOP | PWP | 16 | 90 | RoHS & Green | NIPDAU | Level-2-260C-1 YEAR | -40 to 125 | 2475AI | Samples |
| TLV2475AIPWPR | ACTIVE | HTSSOP | PWP | 16 | 2000 | RoHS & Green | NIPDAU | Level-2-260C-1 YEAR | -40 to 125 | 2475AI | Samples |
| TLV2475CDR | ACTIVE | SOIC | D | 16 | 2500 | RoHS & Green | NIPDAU | Level-1-260C-UNLIM | 0 to 70 | TLV2475C | Samples |
| TLV2475CN | ACTIVE | PDIP | N | 16 | 25 | RoHS & Green | NIPDAU | N / A for Pkg Type | 0 to 70 | TLV2475C | Samples |
| TLV2475CPWPR | ACTIVE | HTSSOP | PWP | 16 | 2000 | RoHS & Green | NIPDAU | Level-2-260C-1 YEAR | 0 to 70 | 2475C | Samples |
| TLV2475IPWPR | ACTIVE | HTSSOP | PWP | 16 | 2000 | RoHS & Green | NIPDAU | Level-2-260C-1 YEAR | -40 to 125 | 2475I | Samples |

(1) The marketing status values are defined as follows:

ACTIVE: Product device recommended for new designs.

LIFEBUY: TI has announced that the device will be discontinued, and a lifetime-buy period is in effect.

NRND: Not recommended for new designs. Device is in production to support existing customers, but TI does not recommend using this part in a new design.

PREVIEW: Device has been announced but is not in production. Samples may or may not be available.

OBSELETE: TI has discontinued the production of the device.

(2) **RoHS:** TI defines "RoHS" to mean semiconductor products that are compliant with the current EU RoHS requirements for all 10 RoHS substances, including the requirement that RoHS substance do not exceed 0.1% by weight in homogeneous materials. Where designed to be soldered at high temperatures, "RoHS" products are suitable for use in specified lead-free processes. TI may reference these types of products as "Pb-Free".

RoHS Exempt: TI defines "RoHS Exempt" to mean products that contain lead but are compliant with EU RoHS pursuant to a specific EU RoHS exemption.

Green: TI defines "Green" to mean the content of Chlorine (Cl) and Bromine (Br) based flame retardants meet JS709B low halogen requirements of <=1000ppm threshold. Antimony trioxide based flame retardants must also meet the <=1000ppm threshold requirement.

(3) MSL, Peak Temp. - The Moisture Sensitivity Level rating according to the JEDEC industry standard classifications, and peak solder temperature.

(4) There may be additional marking, which relates to the logo, the lot trace code information, or the environmental category on the device.

(5) Multiple Device Markings will be inside parentheses. Only one Device Marking contained in parentheses and separated by a "~" will appear on a device. If a line is indented then it is a continuation of the previous line and the two combined represent the entire Device Marking for that device.

(6) Lead finish/Ball material - Orderable Devices may have multiple material finish options. Finish options are separated by a vertical ruled line. Lead finish/Ball material values may wrap to two lines if the finish value exceeds the maximum column width.

Important Information and Disclaimer:The information provided on this page represents TI's knowledge and belief as of the date that it is provided. TI bases its knowledge and belief on information provided by third parties, and makes no representation or warranty as to the accuracy of such information. Efforts are underway to better integrate information from third parties. TI has taken and continues to take reasonable steps to provide representative and accurate information but may not have conducted destructive testing or chemical analysis on incoming materials and chemicals. TI and TI suppliers consider certain information to be proprietary, and thus CAS numbers and other limited information may not be available for release.

In no event shall TI's liability arising out of such information exceed the total purchase price of the TI part(s) at issue in this document sold by TI to Customer on an annual basis.

OTHER QUALIFIED VERSIONS OF TLV2471, TLV2471A, TLV2472, TLV2472A, TLV2474, TLV2474A :

- Automotive : [TLV2471-Q1](#), [TLV2471A-Q1](#), [TLV2472-Q1](#), [TLV2472A-Q1](#), [TLV2474-Q1](#), [TLV2474A-Q1](#)

NOTE: Qualified Version Definitions:

- Automotive - Q100 devices qualified for high-reliability automotive applications targeting zero defects

TAPE AND REEL INFORMATION

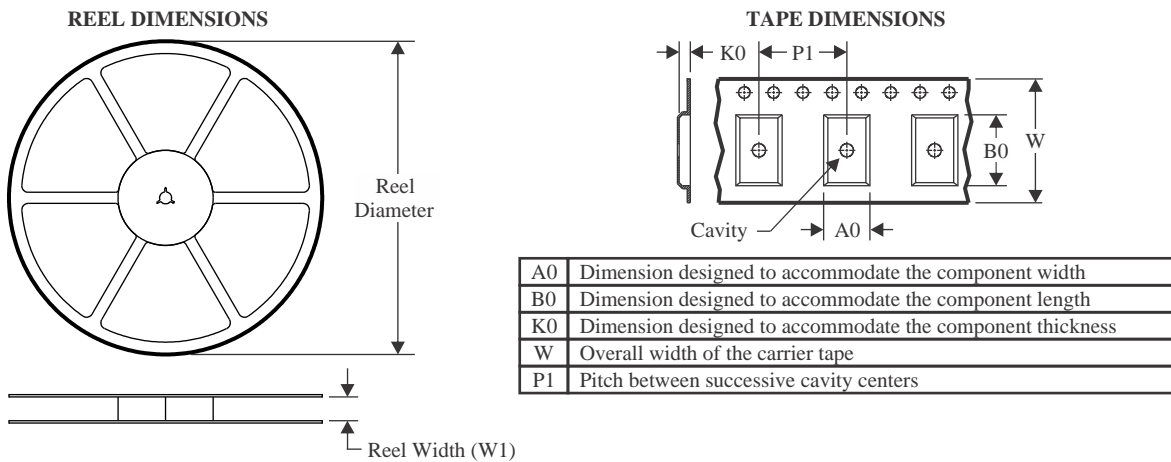

QUADRANT ASSIGNMENTS FOR PIN 1 ORIENTATION IN TAPE

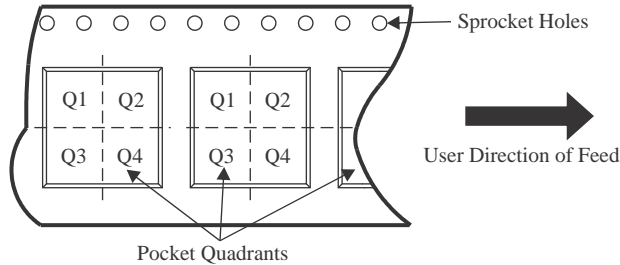

*All dimensions are nominal

| Device | Package Type | Package Drawing | Pins | SPQ | Reel Diameter (mm) | Reel Width W1 (mm) | A0 (mm) | B0 (mm) | K0 (mm) | P1 (mm) | W (mm) | Pin1 Quadrant |
|--------------|--------------|-----------------|------|------|--------------------|--------------------|---------|---------|---------|---------|--------|---------------|
| TLV2470CDBVR | SOT-23 | DBV | 6 | 3000 | 178.0 | 9.0 | 3.23 | 3.17 | 1.37 | 4.0 | 8.0 | Q3 |
| TLV2470CDBVT | SOT-23 | DBV | 6 | 250 | 178.0 | 9.0 | 3.23 | 3.17 | 1.37 | 4.0 | 8.0 | Q3 |
| TLV2470CDR | SOIC | D | 8 | 2500 | 330.0 | 12.4 | 6.4 | 5.2 | 2.1 | 8.0 | 12.0 | Q1 |
| TLV2470IDBVR | SOT-23 | DBV | 6 | 3000 | 178.0 | 9.0 | 3.23 | 3.17 | 1.37 | 4.0 | 8.0 | Q3 |
| TLV2470IDBVT | SOT-23 | DBV | 6 | 250 | 178.0 | 9.0 | 3.23 | 3.17 | 1.37 | 4.0 | 8.0 | Q3 |
| TLV2470IDR | SOIC | D | 8 | 2500 | 330.0 | 12.4 | 6.4 | 5.2 | 2.1 | 8.0 | 12.0 | Q1 |
| TLV2471AIDR | SOIC | D | 8 | 2500 | 330.0 | 12.4 | 6.4 | 5.2 | 2.1 | 8.0 | 12.0 | Q1 |
| TLV2471CDBVR | SOT-23 | DBV | 5 | 3000 | 180.0 | 8.4 | 3.2 | 3.2 | 1.4 | 4.0 | 8.0 | Q3 |
| TLV2471CDBVT | SOT-23 | DBV | 5 | 250 | 180.0 | 8.4 | 3.2 | 3.2 | 1.4 | 4.0 | 8.0 | Q3 |
| TLV2471CDR | SOIC | D | 8 | 2500 | 330.0 | 12.4 | 6.4 | 5.2 | 2.1 | 8.0 | 12.0 | Q1 |
| TLV2471IDBVR | SOT-23 | DBV | 5 | 3000 | 180.0 | 8.4 | 3.2 | 3.2 | 1.4 | 4.0 | 8.0 | Q3 |
| TLV2471IDBVT | SOT-23 | DBV | 5 | 250 | 180.0 | 8.4 | 3.2 | 3.2 | 1.4 | 4.0 | 8.0 | Q3 |
| TLV2471IDR | SOIC | D | 8 | 2500 | 330.0 | 12.4 | 6.4 | 5.2 | 2.1 | 8.0 | 12.0 | Q1 |
| TLV2472AIDR | SOIC | D | 8 | 2500 | 330.0 | 12.4 | 6.4 | 5.2 | 2.1 | 8.0 | 12.0 | Q1 |
| TLV2472CDGNR | HVSSOP | DGN | 8 | 2500 | 330.0 | 12.4 | 5.3 | 3.4 | 1.4 | 8.0 | 12.0 | Q1 |
| TLV2472CDR | SOIC | D | 8 | 2500 | 330.0 | 12.4 | 6.4 | 5.2 | 2.1 | 8.0 | 12.0 | Q1 |



PACKAGE MATERIALS INFORMATION

www.ti.com

5-Nov-2024

| Device | Package Type | Package Drawing | Pins | SPQ | Reel Diameter (mm) | Reel Width W1 (mm) | A0 (mm) | B0 (mm) | K0 (mm) | P1 (mm) | W (mm) | Pin1 Quadrant |
|---------------|--------------|-----------------|------|------|--------------------|--------------------|---------|---------|---------|---------|--------|---------------|
| TLV2472IDGNR | HVSSOP | DGN | 8 | 2500 | 330.0 | 12.4 | 5.3 | 3.4 | 1.4 | 8.0 | 12.0 | Q1 |
| TLV2472IDR | SOIC | D | 8 | 2500 | 330.0 | 12.4 | 6.4 | 5.2 | 2.1 | 8.0 | 12.0 | Q1 |
| TLV2473AIDR | SOIC | D | 14 | 2500 | 330.0 | 16.4 | 6.5 | 9.0 | 2.1 | 8.0 | 16.0 | Q1 |
| TLV2473CDGQR | HVSSOP | DGQ | 10 | 2500 | 330.0 | 12.4 | 5.3 | 3.4 | 1.4 | 8.0 | 12.0 | Q1 |
| TLV2473CDGQR | HVSSOP | DGQ | 10 | 2500 | 330.0 | 12.4 | 5.3 | 3.4 | 1.4 | 8.0 | 12.0 | Q1 |
| TLV2473CDR | SOIC | D | 14 | 2500 | 330.0 | 16.4 | 6.5 | 9.0 | 2.1 | 8.0 | 16.0 | Q1 |
| TLV2473IDGQR | HVSSOP | DGQ | 10 | 2500 | 330.0 | 12.4 | 5.3 | 3.4 | 1.4 | 8.0 | 12.0 | Q1 |
| TLV2474AIDR | SOIC | D | 14 | 2500 | 330.0 | 16.4 | 6.5 | 9.0 | 2.1 | 8.0 | 16.0 | Q1 |
| TLV2474AIPWPR | HTSSOP | PWP | 14 | 2000 | 330.0 | 12.4 | 6.9 | 5.6 | 1.6 | 8.0 | 12.0 | Q1 |
| TLV2474AIPWR | TSSOP | PW | 14 | 2000 | 330.0 | 12.4 | 6.9 | 5.6 | 1.6 | 8.0 | 12.0 | Q1 |
| TLV2474CDR | SOIC | D | 14 | 2500 | 330.0 | 16.4 | 6.5 | 9.0 | 2.1 | 8.0 | 16.0 | Q1 |
| TLV2474CPWPR | HTSSOP | PWP | 14 | 2000 | 330.0 | 12.4 | 6.9 | 5.6 | 1.6 | 8.0 | 12.0 | Q1 |
| TLV2474IDR | SOIC | D | 14 | 2500 | 330.0 | 16.4 | 6.5 | 9.0 | 2.1 | 8.0 | 16.0 | Q1 |
| TLV2474IPWPR | HTSSOP | PWP | 14 | 2000 | 330.0 | 12.4 | 6.9 | 5.6 | 1.6 | 8.0 | 12.0 | Q1 |
| TLV2475AIDR | SOIC | D | 16 | 2500 | 330.0 | 16.4 | 6.5 | 10.3 | 2.1 | 8.0 | 16.0 | Q1 |
| TLV2475AIPWPR | HTSSOP | PWP | 16 | 2000 | 330.0 | 12.4 | 6.9 | 5.6 | 1.6 | 8.0 | 12.0 | Q1 |
| TLV2475CDR | SOIC | D | 16 | 2500 | 330.0 | 16.4 | 6.5 | 10.3 | 2.1 | 8.0 | 16.0 | Q1 |
| TLV2475CPWPR | HTSSOP | PWP | 16 | 2000 | 330.0 | 12.4 | 6.9 | 5.6 | 1.6 | 8.0 | 12.0 | Q1 |
| TLV2475IPWPR | HTSSOP | PWP | 16 | 2000 | 330.0 | 12.4 | 6.9 | 5.6 | 1.6 | 8.0 | 12.0 | Q1 |

TAPE AND REEL BOX DIMENSIONS

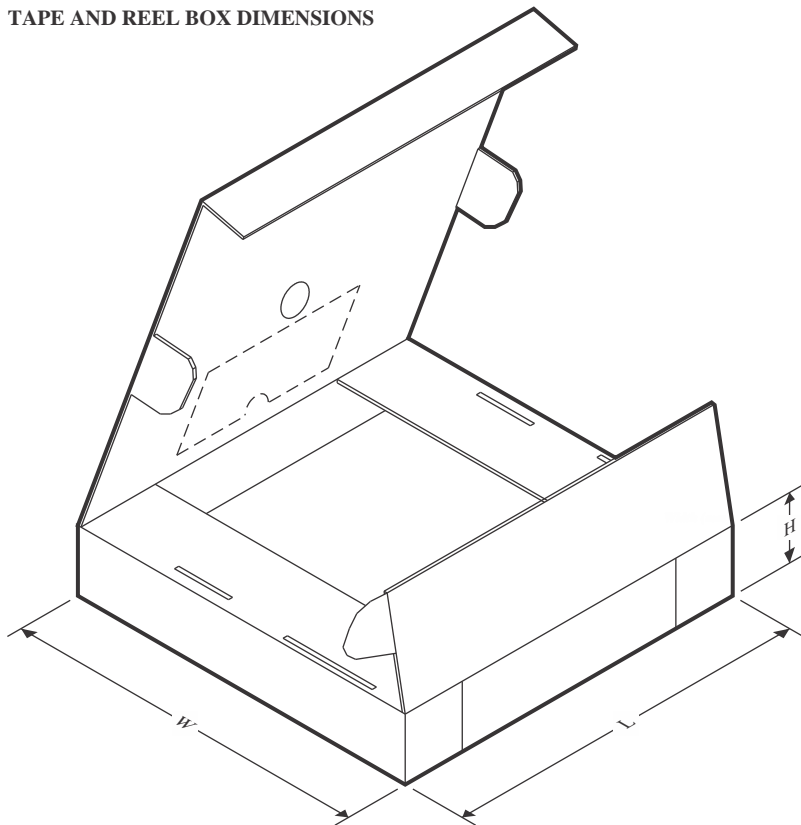

*All dimensions are nominal

| Device | Package Type | Package Drawing | Pins | SPQ | Length (mm) | Width (mm) | Height (mm) |
|--------------|--------------|-----------------|------|------|-------------|------------|-------------|
| TLV2470CDBVR | SOT-23 | DBV | 6 | 3000 | 180.0 | 180.0 | 18.0 |
| TLV2470CDBVT | SOT-23 | DBV | 6 | 250 | 180.0 | 180.0 | 18.0 |
| TLV2470CDR | SOIC | D | 8 | 2500 | 340.5 | 338.1 | 20.6 |
| TLV2470IDBVR | SOT-23 | DBV | 6 | 3000 | 180.0 | 180.0 | 18.0 |
| TLV2470IDBVT | SOT-23 | DBV | 6 | 250 | 180.0 | 180.0 | 18.0 |
| TLV2470IDR | SOIC | D | 8 | 2500 | 353.0 | 353.0 | 32.0 |
| TLV2471AIDR | SOIC | D | 8 | 2500 | 340.5 | 338.1 | 20.6 |
| TLV2471CDBVR | SOT-23 | DBV | 5 | 3000 | 210.0 | 185.0 | 35.0 |
| TLV2471CDBVT | SOT-23 | DBV | 5 | 250 | 210.0 | 185.0 | 35.0 |
| TLV2471CDR | SOIC | D | 8 | 2500 | 340.5 | 338.1 | 20.6 |
| TLV2471IDBVR | SOT-23 | DBV | 5 | 3000 | 210.0 | 185.0 | 35.0 |
| TLV2471IDBVT | SOT-23 | DBV | 5 | 250 | 210.0 | 185.0 | 35.0 |
| TLV2471IDR | SOIC | D | 8 | 2500 | 340.5 | 338.1 | 20.6 |
| TLV2472AIDR | SOIC | D | 8 | 2500 | 353.0 | 353.0 | 32.0 |
| TLV2472CDGNR | HVSSOP | DGN | 8 | 2500 | 358.0 | 335.0 | 35.0 |
| TLV2472CDR | SOIC | D | 8 | 2500 | 353.0 | 353.0 | 32.0 |
| TLV2472IDGNR | HVSSOP | DGN | 8 | 2500 | 358.0 | 335.0 | 35.0 |
| TLV2472IDR | SOIC | D | 8 | 2500 | 353.0 | 353.0 | 32.0 |



PACKAGE MATERIALS INFORMATION

www.ti.com

5-Nov-2024

| Device | Package Type | Package Drawing | Pins | SPQ | Length (mm) | Width (mm) | Height (mm) |
|---------------|--------------|-----------------|------|------|-------------|------------|-------------|
| TLV2473AIDR | SOIC | D | 14 | 2500 | 350.0 | 350.0 | 43.0 |
| TLV2473CDGQR | HVSSOP | DGQ | 10 | 2500 | 364.0 | 364.0 | 27.0 |
| TLV2473CDGQR | HVSSOP | DGQ | 10 | 2500 | 358.0 | 335.0 | 35.0 |
| TLV2473CDR | SOIC | D | 14 | 2500 | 350.0 | 350.0 | 43.0 |
| TLV2473IDGQR | HVSSOP | DGQ | 10 | 2500 | 358.0 | 335.0 | 35.0 |
| TLV2474AIDR | SOIC | D | 14 | 2500 | 350.0 | 350.0 | 43.0 |
| TLV2474AIPWPR | HTSSOP | PWP | 14 | 2000 | 350.0 | 350.0 | 43.0 |
| TLV2474AIPWR | TSSOP | PW | 14 | 2000 | 356.0 | 356.0 | 35.0 |
| TLV2474CDR | SOIC | D | 14 | 2500 | 350.0 | 350.0 | 43.0 |
| TLV2474CPWPR | HTSSOP | PWP | 14 | 2000 | 350.0 | 350.0 | 43.0 |
| TLV2474IDR | SOIC | D | 14 | 2500 | 350.0 | 350.0 | 43.0 |
| TLV2474IPWPR | HTSSOP | PWP | 14 | 2000 | 350.0 | 350.0 | 43.0 |
| TLV2475AIDR | SOIC | D | 16 | 2500 | 350.0 | 350.0 | 43.0 |
| TLV2475AIPWPR | HTSSOP | PWP | 16 | 2000 | 350.0 | 350.0 | 43.0 |
| TLV2475CDR | SOIC | D | 16 | 2500 | 350.0 | 350.0 | 43.0 |
| TLV2475CPWPR | HTSSOP | PWP | 16 | 2000 | 350.0 | 350.0 | 43.0 |
| TLV2475IPWPR | HTSSOP | PWP | 16 | 2000 | 350.0 | 350.0 | 43.0 |

TUBE

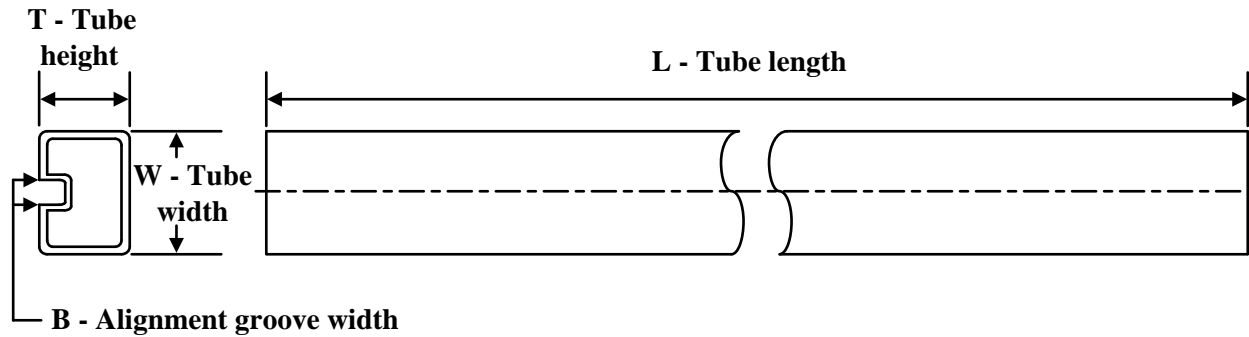

*All dimensions are nominal

| Device | Package Name | Package Type | Pins | SPQ | L (mm) | W (mm) | T (μm) | B (mm) |
|------------|--------------|--------------|------|-----|--------|--------|--------|--------|
| TLV2470AID | D | SOIC | 8 | 75 | 507 | 8 | 3940 | 4.32 |
| TLV2470AID | D | SOIC | 8 | 75 | 505.46 | 6.76 | 3810 | 4 |
| TLV2470AIP | P | PDIP | 8 | 50 | 506 | 13.97 | 11230 | 4.32 |
| TLV2470CD | D | SOIC | 8 | 75 | 505.46 | 6.76 | 3810 | 4 |
| TLV2470CD | D | SOIC | 8 | 75 | 507 | 8 | 3940 | 4.32 |
| TLV2470CP | P | PDIP | 8 | 50 | 506 | 13.97 | 11230 | 4.32 |
| TLV2470ID | D | SOIC | 8 | 75 | 507 | 8 | 3940 | 4.32 |
| TLV2470ID | D | SOIC | 8 | 75 | 505.46 | 6.76 | 3810 | 4 |
| TLV2471AID | D | SOIC | 8 | 75 | 505.46 | 6.76 | 3810 | 4 |
| TLV2471AID | D | SOIC | 8 | 75 | 507 | 8 | 3940 | 4.32 |
| TLV2471AIP | P | PDIP | 8 | 50 | 506 | 13.97 | 11230 | 4.32 |
| TLV2471CD | D | SOIC | 8 | 75 | 507 | 8 | 3940 | 4.32 |
| TLV2471CD | D | SOIC | 8 | 75 | 505.46 | 6.76 | 3810 | 4 |
| TLV2471CP | P | PDIP | 8 | 50 | 506 | 13.97 | 11230 | 4.32 |
| TLV2471ID | D | SOIC | 8 | 75 | 505.46 | 6.76 | 3810 | 4 |
| TLV2471ID | D | SOIC | 8 | 75 | 507 | 8 | 3940 | 4.32 |
| TLV2471IP | P | PDIP | 8 | 50 | 506 | 13.97 | 11230 | 4.32 |
| TLV2472AID | D | SOIC | 8 | 75 | 507 | 8 | 3940 | 4.32 |
| TLV2472AID | D | SOIC | 8 | 75 | 505.46 | 6.76 | 3810 | 4 |
| TLV2472AIP | P | PDIP | 8 | 50 | 506 | 13.97 | 11230 | 4.32 |
| TLV2472CD | D | SOIC | 8 | 75 | 507 | 8 | 3940 | 4.32 |
| TLV2472CD | D | SOIC | 8 | 75 | 505.46 | 6.76 | 3810 | 4 |
| TLV2472CP | P | PDIP | 8 | 50 | 506 | 13.97 | 11230 | 4.32 |
| TLV2472ID | D | SOIC | 8 | 75 | 505.46 | 6.76 | 3810 | 4 |
| TLV2472ID | D | SOIC | 8 | 75 | 507 | 8 | 3940 | 4.32 |
| TLV2472IP | P | PDIP | 8 | 50 | 506 | 13.97 | 11230 | 4.32 |
| TLV2473AIN | N | PDIP | 14 | 25 | 506 | 13.97 | 11230 | 4.32 |
| TLV2473CD | D | SOIC | 14 | 50 | 505.46 | 6.76 | 3810 | 4 |
| TLV2473IN | N | PDIP | 14 | 25 | 506 | 13.97 | 11230 | 4.32 |



PACKAGE MATERIALS INFORMATION

www.ti.com

5-Nov-2024

| Device | Package Name | Package Type | Pins | SPQ | L (mm) | W (mm) | T (μm) | B (mm) |
|--------------|--------------|--------------|------|-----|--------|--------|--------|--------|
| TLV2474AID | D | SOIC | 14 | 50 | 505.46 | 6.76 | 3810 | 4 |
| TLV2474AIN | N | PDIP | 14 | 25 | 506 | 13.97 | 11230 | 4.32 |
| TLV2474AIPWP | PWP | HTSSOP | 14 | 90 | 530 | 10.2 | 3600 | 3.5 |
| TLV2474CD | D | SOIC | 14 | 50 | 505.46 | 6.76 | 3810 | 4 |
| TLV2474CN | N | PDIP | 14 | 25 | 506 | 13.97 | 11230 | 4.32 |
| TLV2474CPWP | PWP | HTSSOP | 14 | 90 | 530 | 10.2 | 3600 | 3.5 |
| TLV2474ID | D | SOIC | 14 | 50 | 505.46 | 6.76 | 3810 | 4 |
| TLV2474IN | N | PDIP | 14 | 25 | 506 | 13.97 | 11230 | 4.32 |
| TLV2474IPWP | PWP | HTSSOP | 14 | 90 | 530 | 10.2 | 3600 | 3.5 |
| TLV2475AIPWP | PWP | HTSSOP | 16 | 90 | 530 | 10.2 | 3600 | 3.5 |
| TLV2475CN | N | PDIP | 16 | 25 | 506 | 13.97 | 11230 | 4.32 |

GENERIC PACKAGE VIEW

DGQ 10

PowerPAD™ HVSSOP - 1.1 mm max height

3 x 3, 0.5 mm pitch

PLASTIC SMALL OUTLINE

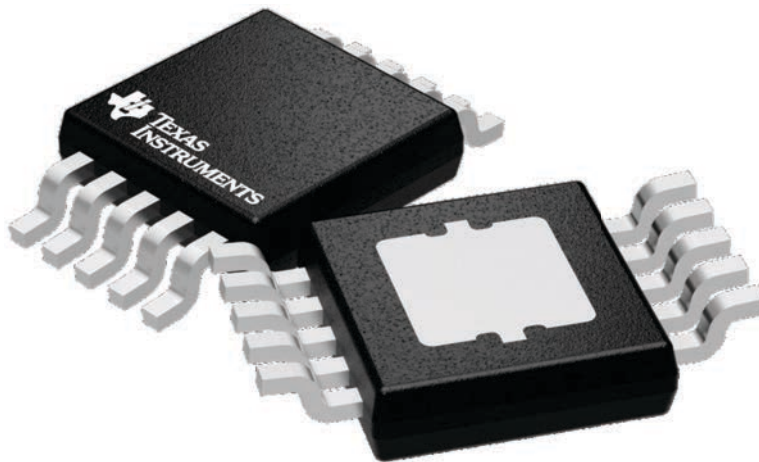

Images above are just a representation of the package family, actual package may vary.
Refer to the product data sheet for package details.

4224775/A



PACKAGE OUTLINE

DGQ0010D

PowerPAD™ - 1.1 mm max height

PLASTIC SMALL OUTLINE

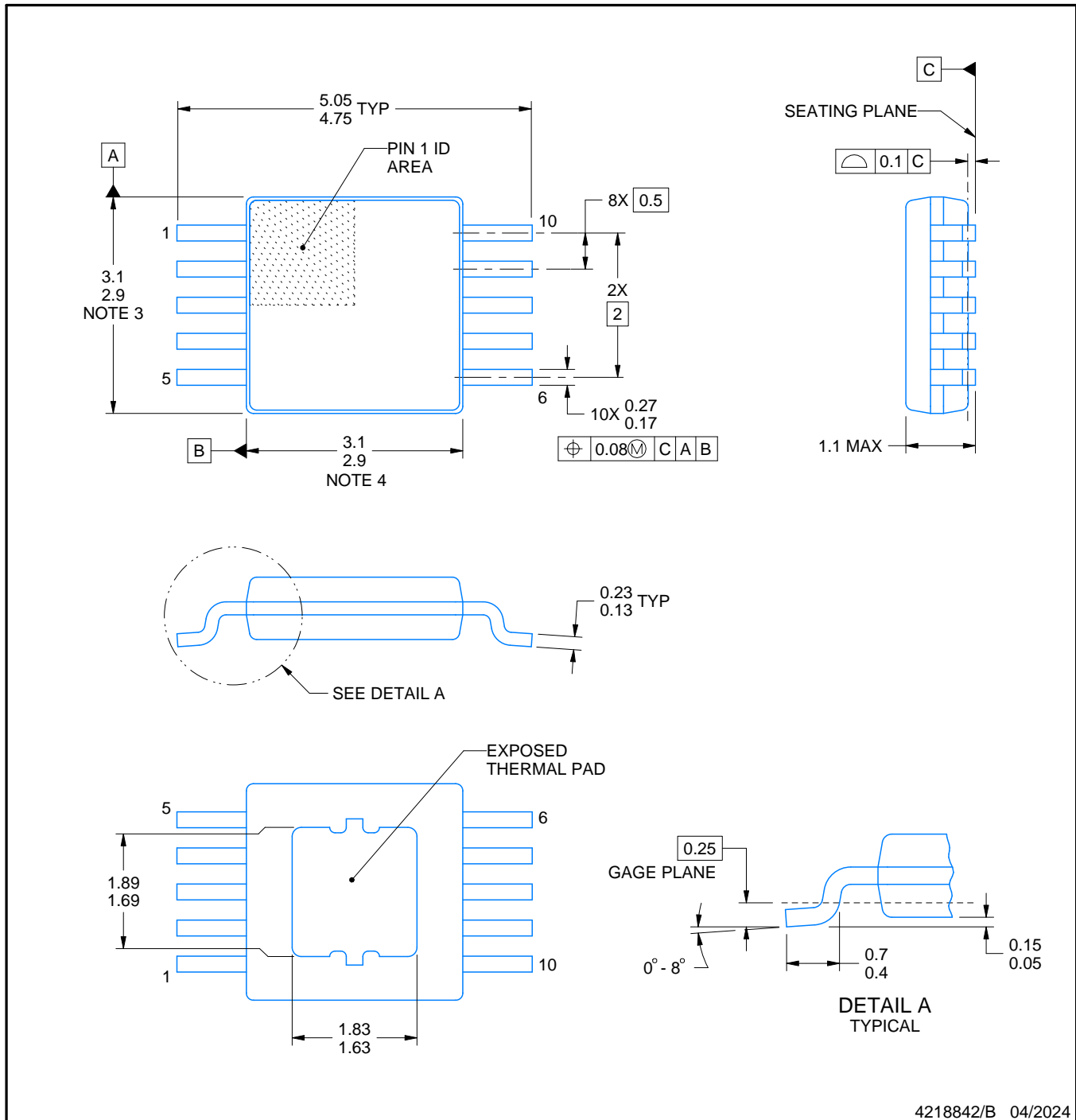

PowerPAD is a trademark of Texas Instruments.

NOTES:

- All linear dimensions are in millimeters. Any dimensions in parenthesis are for reference only. Dimensioning and tolerancing per ASME Y14.5M.
- This drawing is subject to change without notice.
- This dimension does not include mold flash, protrusions, or gate burrs. Mold flash, protrusions, or gate burrs shall not exceed 0.15 mm per side.
- This dimension does not include interlead flash. Interlead flash shall not exceed 0.25 mm per side.
- Reference JEDEC registration MO-187, variation BA-T.

EXAMPLE BOARD LAYOUT

DGQ0010D

PowerPAD™ - 1.1 mm max height

PLASTIC SMALL OUTLINE

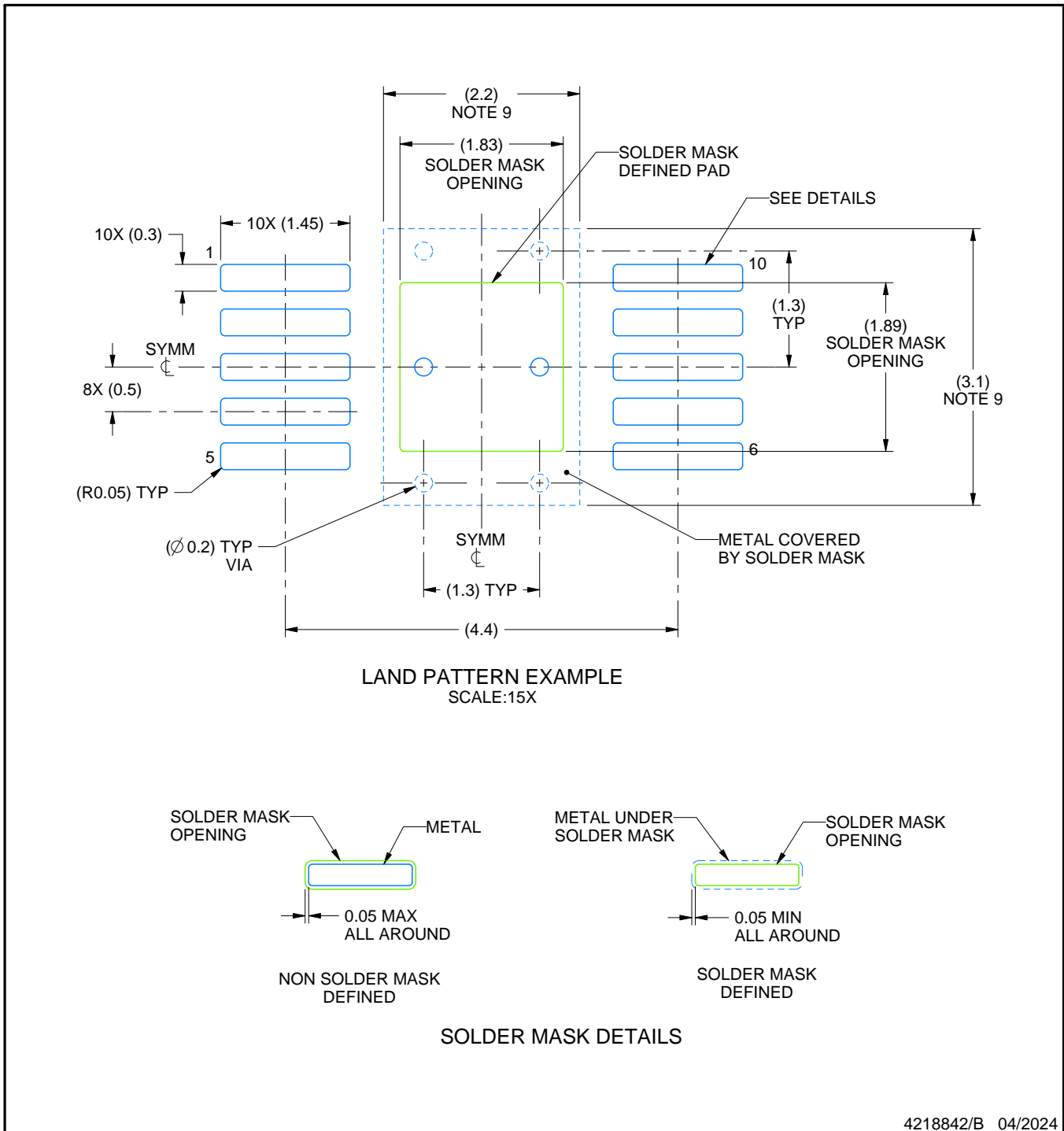

4218842/B 04/2024

NOTES: (continued)

6. Publication IPC-7351 may have alternate designs.
7. Solder mask tolerances between and around signal pads can vary based on board fabrication site.
8. This package is designed to be soldered to a thermal pad on the board. For more information, see Texas Instruments literature numbers SLMA002 (www.ti.com/lit/slma002) and SLMA004 (www.ti.com/lit/slma004).
9. Size of metal pad may vary due to creepage requirement.

EXAMPLE STENCIL DESIGN

DGQ0010D

PowerPAD™ - 1.1 mm max height

PLASTIC SMALL OUTLINE

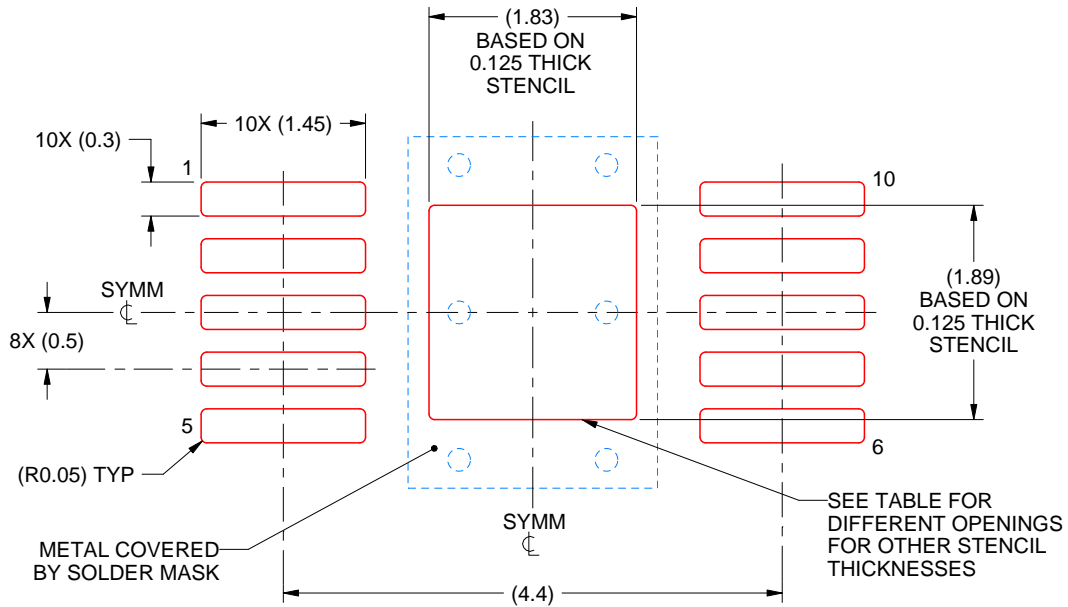

SOLDER PASTE EXAMPLE
 EXPOSED PAD
 100% PRINTED SOLDER COVERAGE BY AREA
 SCALE:15X

| STENCIL THICKNESS | SOLDER STENCIL OPENING |
|-------------------|------------------------|
| 0.1 | 2.05 X 2.11 |
| 0.125 | 1.83 X 1.89 (SHOWN) |
| 0.150 | 1.67 X 1.73 |
| 0.175 | 1.55 X 1.60 |

4218842/B 04/2024

NOTES: (continued)

- 10. Laser cutting apertures with trapezoidal walls and rounded corners may offer better paste release. IPC-7525 may have alternate design recommendations.
- 11. Board assembly site may have different recommendations for stencil design.

GENERIC PACKAGE VIEW

DGN 8

PowerPAD™ HVSSOP - 1.1 mm max height

3 x 3, 0.65 mm pitch

SMALL OUTLINE PACKAGE

This image is a representation of the package family, actual package may vary.
Refer to the product data sheet for package details.

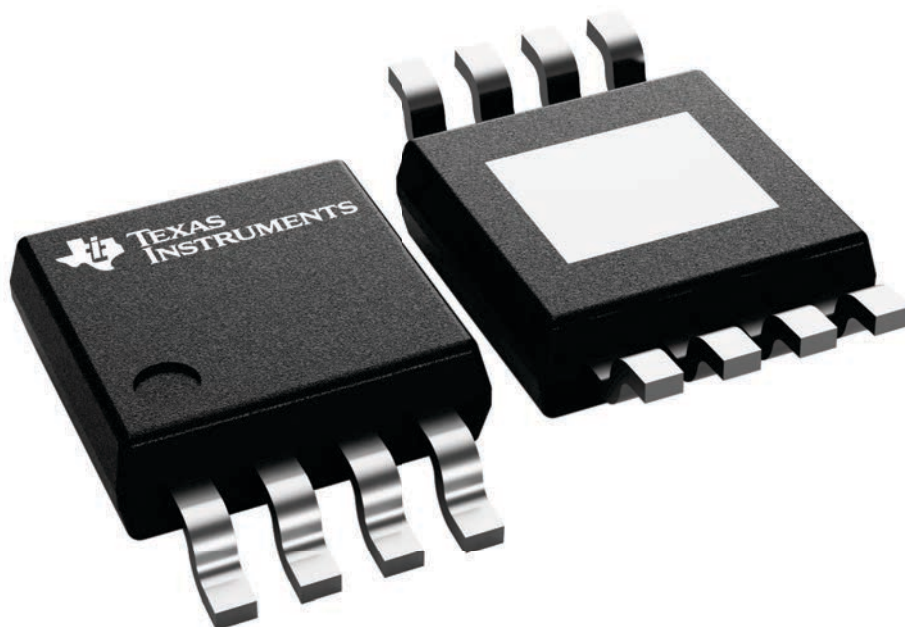

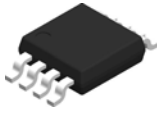

PACKAGE OUTLINE

DGN0008D

PowerPAD™ VSSOP - 1.1 mm max height

SMALL OUTLINE PACKAGE

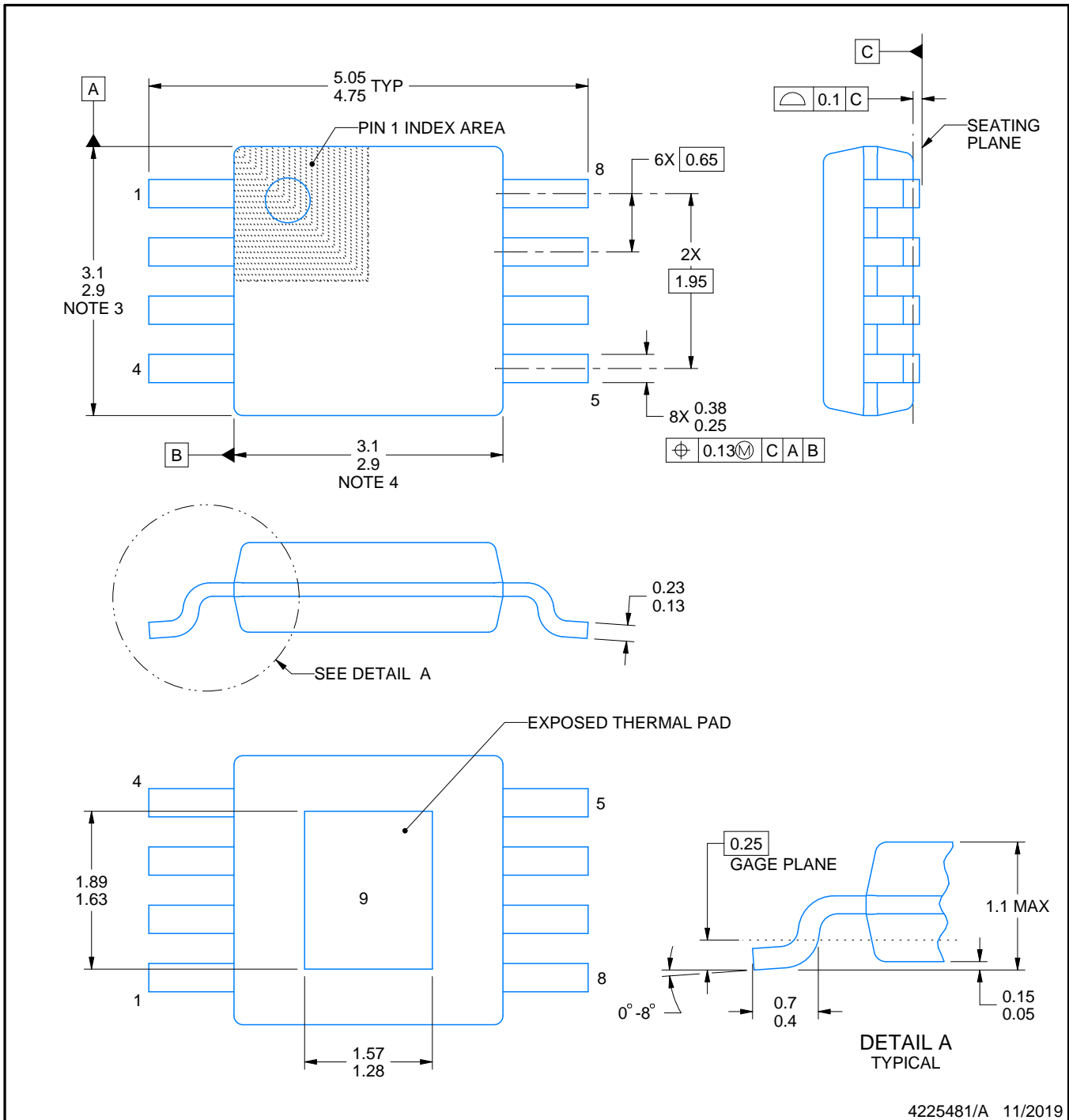

4225481/A 11/2019

PowerPAD is a trademark of Texas Instruments.

NOTES:

1. All linear dimensions are in millimeters. Any dimensions in parenthesis are for reference only. Dimensioning and tolerancing per ASME Y14.5M.
2. This drawing is subject to change without notice.
3. This dimension does not include mold flash, protrusions, or gate burrs. Mold flash, protrusions, or gate burrs shall not exceed 0.15 mm per side.
4. This dimension does not include interlead flash. Interlead flash shall not exceed 0.25 mm per side.
5. Reference JEDEC registration MO-187.

EXAMPLE BOARD LAYOUT

DGN0008D

PowerPAD™ VSSOP - 1.1 mm max height

SMALL OUTLINE PACKAGE

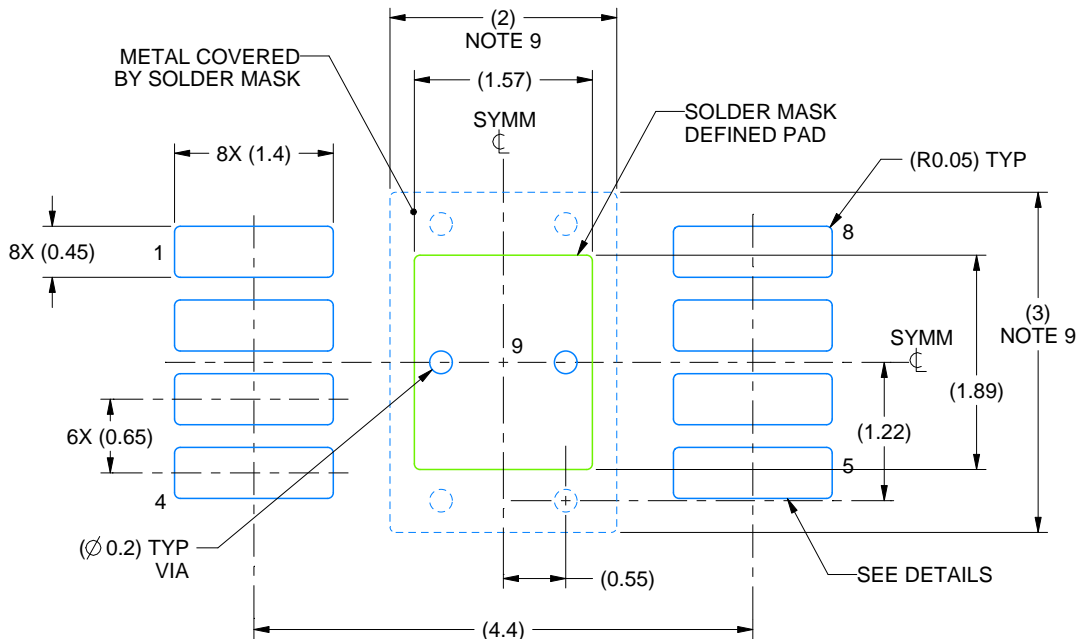

LAND PATTERN EXAMPLE
EXPOSED METAL SHOWN
SCALE: 15X

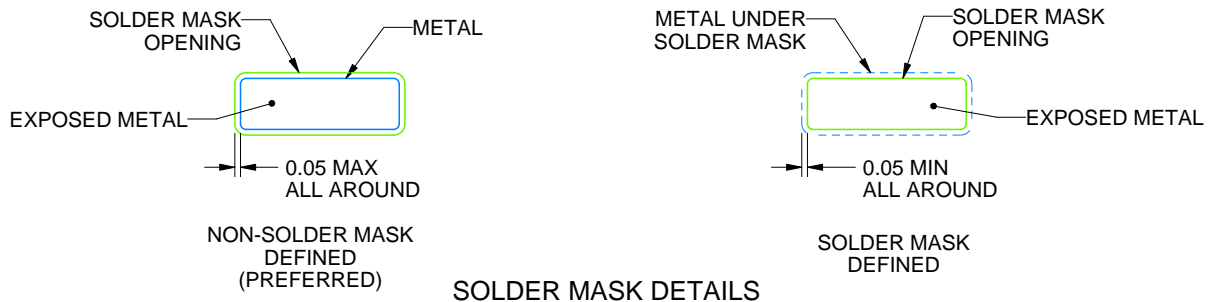

4225481/A 11/2019

NOTES: (continued)

- 6. Publication IPC-7351 may have alternate designs.
- 7. Solder mask tolerances between and around signal pads can vary based on board fabrication site.
- 8. Vias are optional depending on application, refer to device data sheet. If any vias are implemented, refer to their locations shown on this view. It is recommended that vias under paste be filled, plugged or tented.
- 9. Size of metal pad may vary due to creepage requirement.

EXAMPLE STENCIL DESIGN

DGN0008D

PowerPAD™ VSSOP - 1.1 mm max height

SMALL OUTLINE PACKAGE

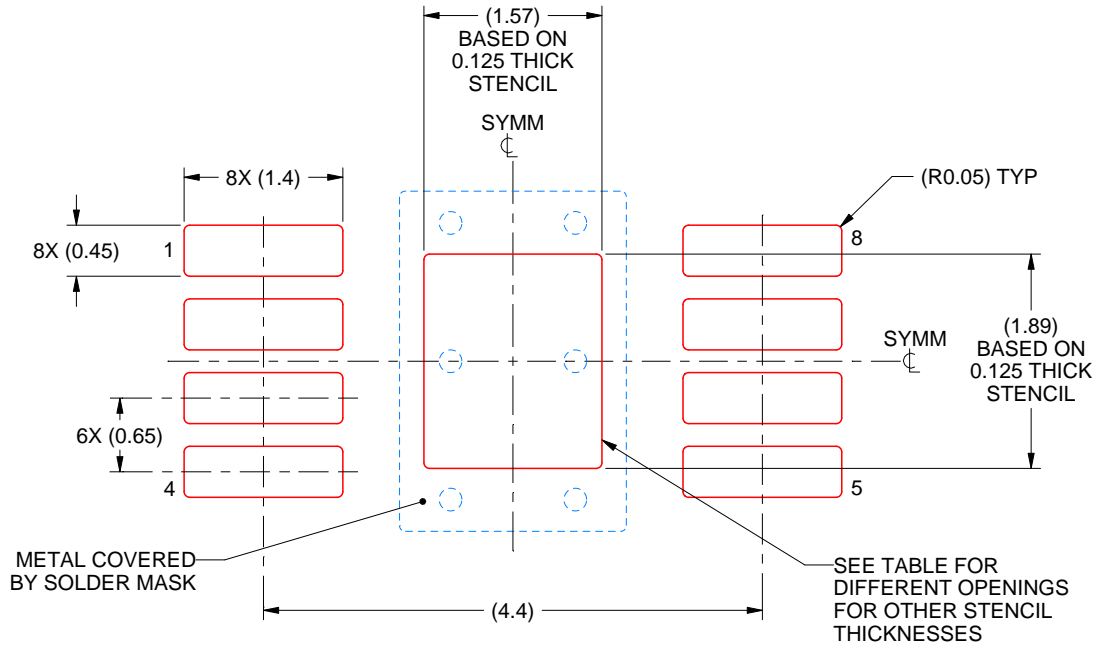

SOLDER PASTE EXAMPLE
EXPOSED PAD 9:
100% PRINTED SOLDER COVERAGE BY AREA
SCALE: 15X

| STENCIL THICKNESS | SOLDER STENCIL OPENING |
|-------------------|------------------------|
| 0.1 | 1.76 X 2.11 |
| 0.125 | 1.57 X 1.89 (SHOWN) |
| 0.15 | 1.43 X 1.73 |
| 0.175 | 1.33 X 1.60 |

4225481/A 11/2019

NOTES: (continued)

10. Laser cutting apertures with trapezoidal walls and rounded corners may offer better paste release. IPC-7525 may have alternate design recommendations.
11. Board assembly site may have different recommendations for stencil design.

GENERIC PACKAGE VIEW

PWP 14

PowerPAD TSSOP - 1.2 mm max height

4.4 x 5.0, 0.65 mm pitch

PLASTIC SMALL OUTLINE

This image is a representation of the package family, actual package may vary.
Refer to the product data sheet for package details.

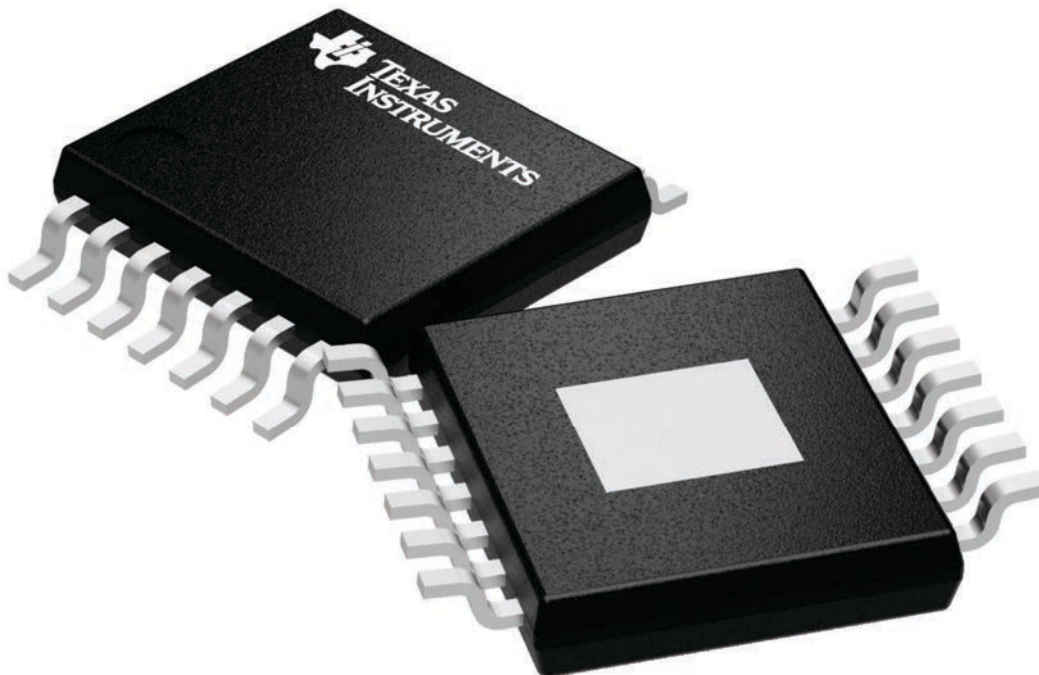

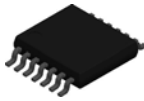

PACKAGE OUTLINE

PWP0014K

PowerPAD™ TSSOP - 1.2 mm max height

SMALL OUTLINE PACKAGE

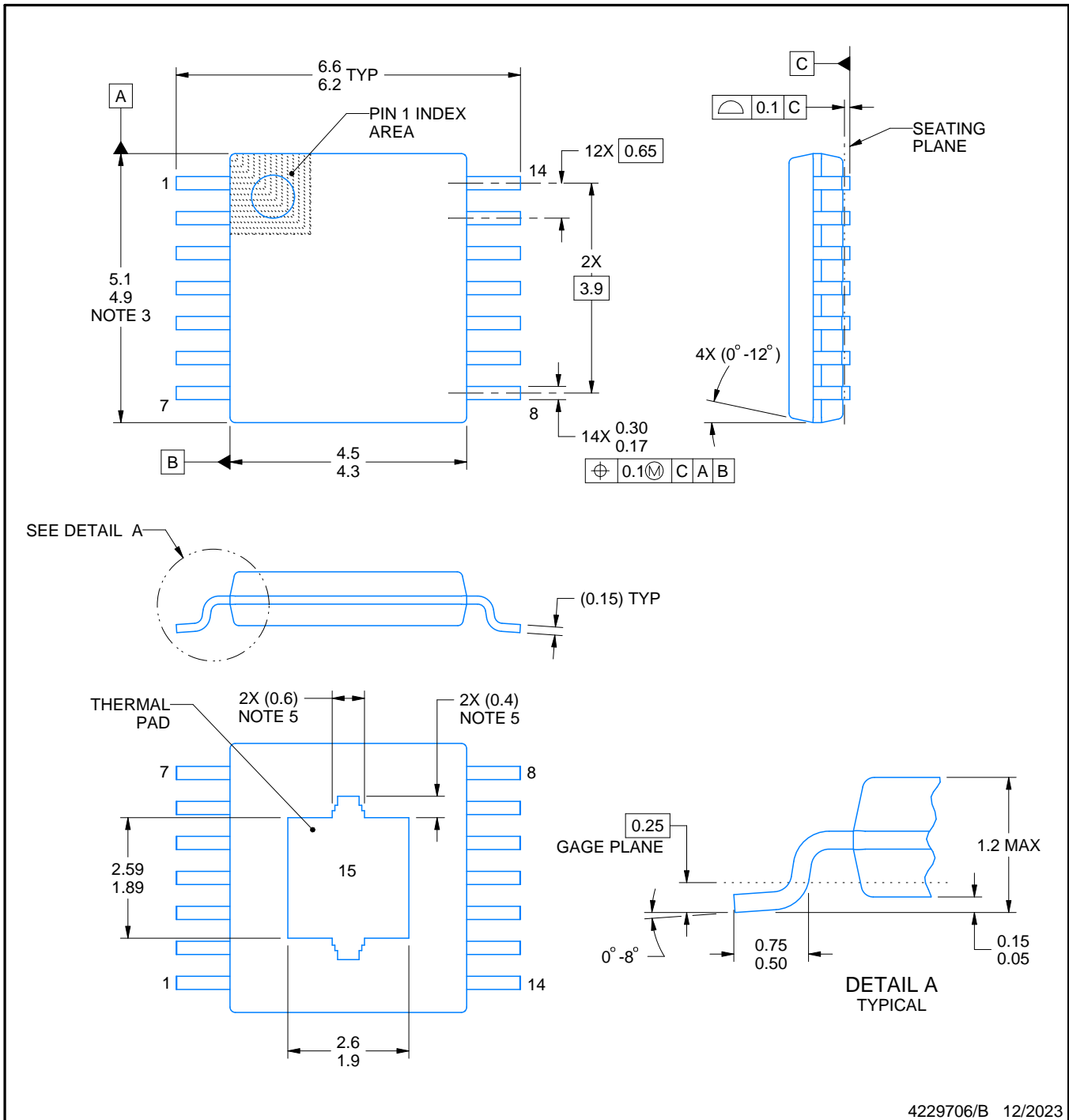

4229706/B 12/2023

NOTES:

PowerPAD is a trademark of Texas Instruments.

1. All linear dimensions are in millimeters. Any dimensions in parenthesis are for reference only. Dimensioning and tolerancing per ASME Y14.5M.
2. This drawing is subject to change without notice.
3. This dimension does not include mold flash, protrusions, or gate burrs. Mold flash, protrusions, or gate burrs shall not exceed 0.15 mm per side.
4. Reference JEDEC registration MO-153.
5. Features may differ or may not be present.

EXAMPLE BOARD LAYOUT

PWP0014K

PowerPAD™ TSSOP - 1.2 mm max height

SMALL OUTLINE PACKAGE

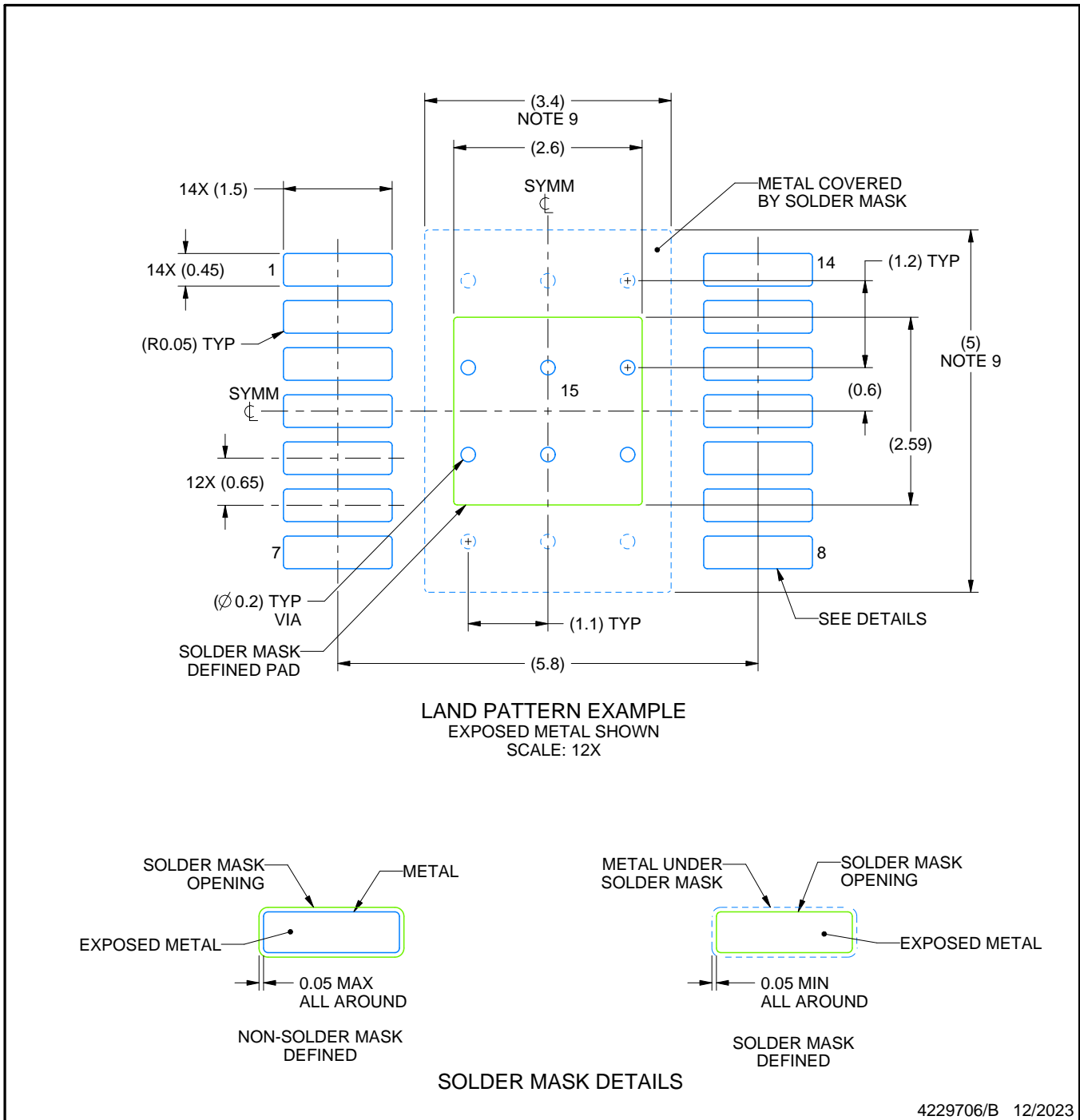

NOTES: (continued)

6. Publication IPC-7351 may have alternate designs.
7. Solder mask tolerances between and around signal pads can vary based on board fabrication site.
8. This package is designed to be soldered to a thermal pad on the board. For more information, see Texas Instruments literature numbers SLMA002 (www.ti.com/lit/slma002) and SLMA004 (www.ti.com/lit/slma004).
9. Size of metal pad may vary due to creepage requirement.
10. Vias are optional depending on application, refer to device data sheet. It is recommended that vias under paste be filled, plugged or tented.

EXAMPLE STENCIL DESIGN

PWP0014K

PowerPAD™ TSSOP - 1.2 mm max height

SMALL OUTLINE PACKAGE

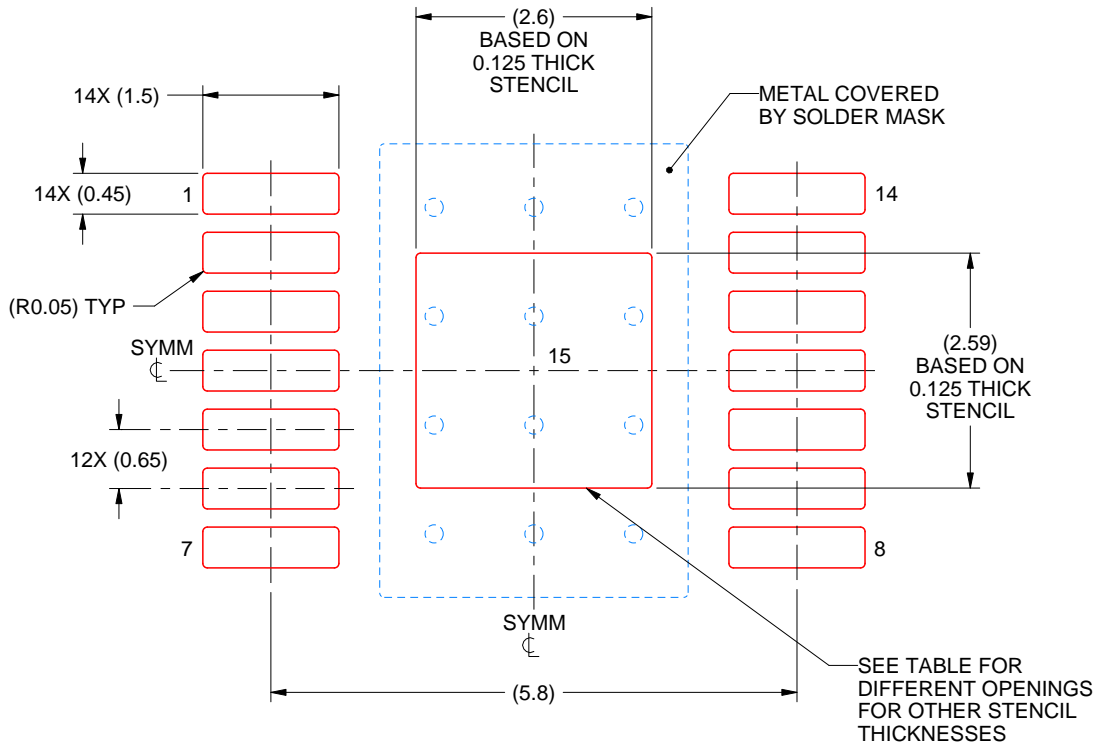

SOLDER PASTE EXAMPLE
 BASED ON 0.125 mm THICK STENCIL
 SCALE: 12X

| STENCIL THICKNESS | SOLDER STENCIL OPENING |
|-------------------|------------------------|
| 0.1 | 2.91 X 2.90 |
| 0.125 | 2.60 X 2.59 (SHOWN) |
| 0.15 | 2.37 X 2.36 |
| 0.175 | 2.20 X 2.19 |

4229706/B 12/2023

NOTES: (continued)

11. Laser cutting apertures with trapezoidal walls and rounded corners may offer better paste release. IPC-7525 may have alternate design recommendations.
12. Board assembly site may have different recommendations for stencil design.

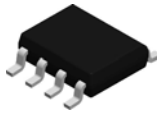
**D0008A****PACKAGE OUTLINE****SOIC - 1.75 mm max height**

SMALL OUTLINE INTEGRATED CIRCUIT

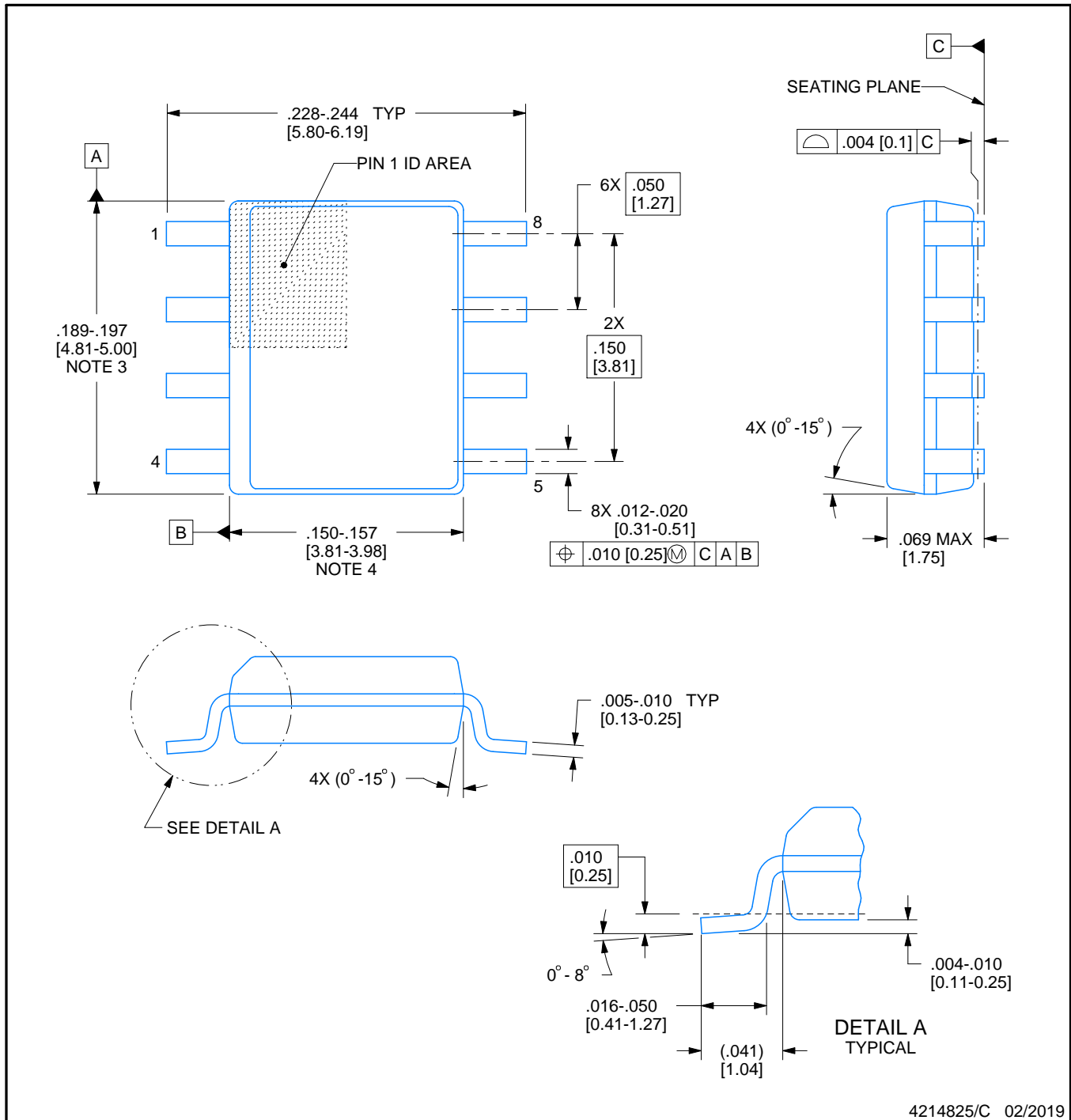

4214825/C 02/2019

NOTES:

- Linear dimensions are in inches [millimeters]. Dimensions in parenthesis are for reference only. Controlling dimensions are in inches. Dimensioning and tolerancing per ASME Y14.5M.
- This drawing is subject to change without notice.
- This dimension does not include mold flash, protrusions, or gate burrs. Mold flash, protrusions, or gate burrs shall not exceed .006 [0.15] per side.
- This dimension does not include interlead flash.
- Reference JEDEC registration MS-012, variation AA.

EXAMPLE BOARD LAYOUT

D0008A

SOIC - 1.75 mm max height

SMALL OUTLINE INTEGRATED CIRCUIT

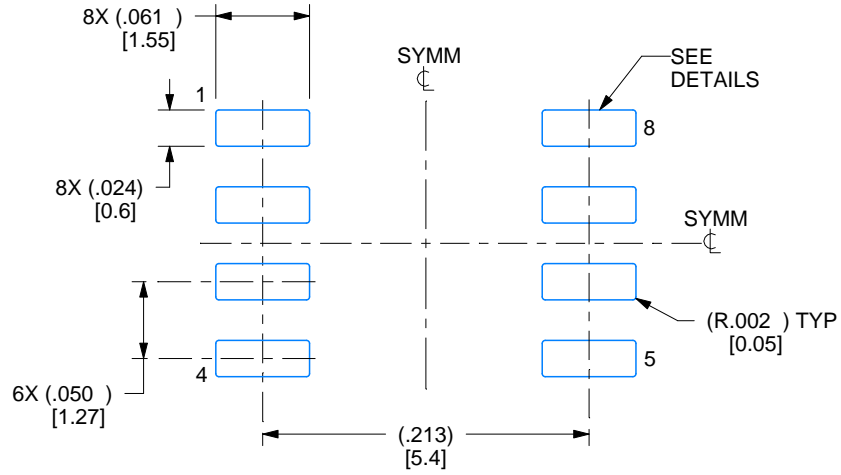

LAND PATTERN EXAMPLE
 EXPOSED METAL SHOWN
 SCALE:8X

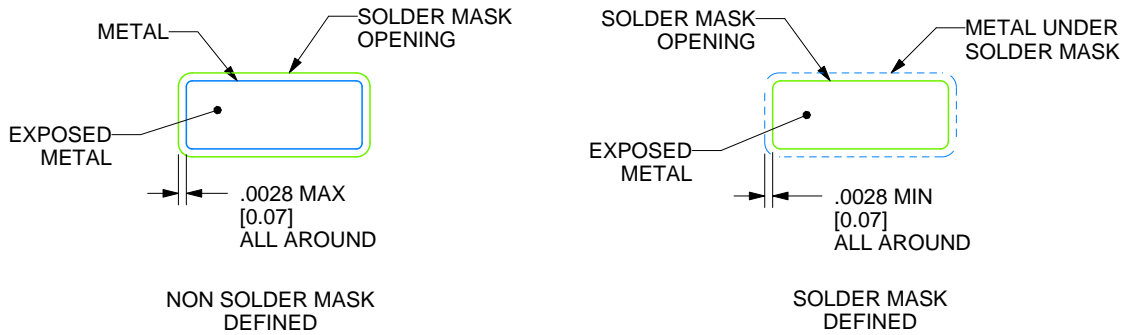

SOLDER MASK DETAILS

4214825/C 02/2019

NOTES: (continued)

- 6. Publication IPC-7351 may have alternate designs.
- 7. Solder mask tolerances between and around signal pads can vary based on board fabrication site.

EXAMPLE STENCIL DESIGN

D0008A

SOIC - 1.75 mm max height

SMALL OUTLINE INTEGRATED CIRCUIT

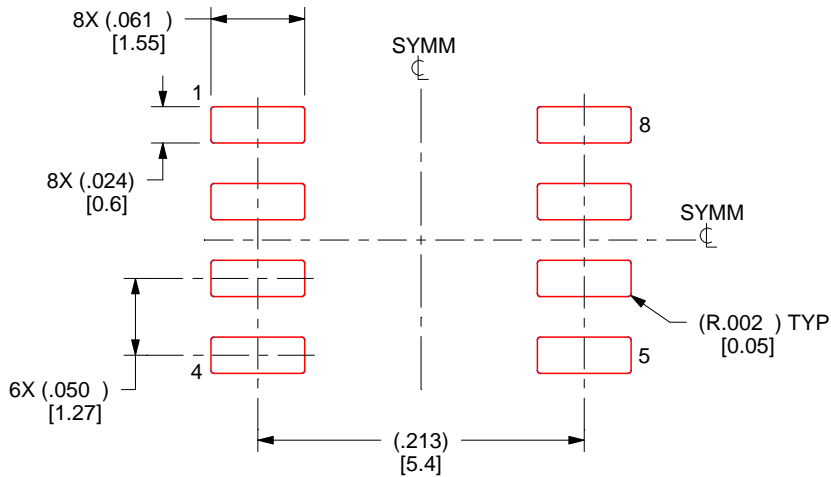

SOLDER PASTE EXAMPLE
 BASED ON .005 INCH [0.125 MM] THICK STENCIL
 SCALE:8X

4214825/C 02/2019

NOTES: (continued)

- 8. Laser cutting apertures with trapezoidal walls and rounded corners may offer better paste release. IPC-7525 may have alternate design recommendations.
- 9. Board assembly site may have different recommendations for stencil design.

MECHANICAL DATA

P (R-PDIP-T8)

PLASTIC DUAL-IN-LINE PACKAGE

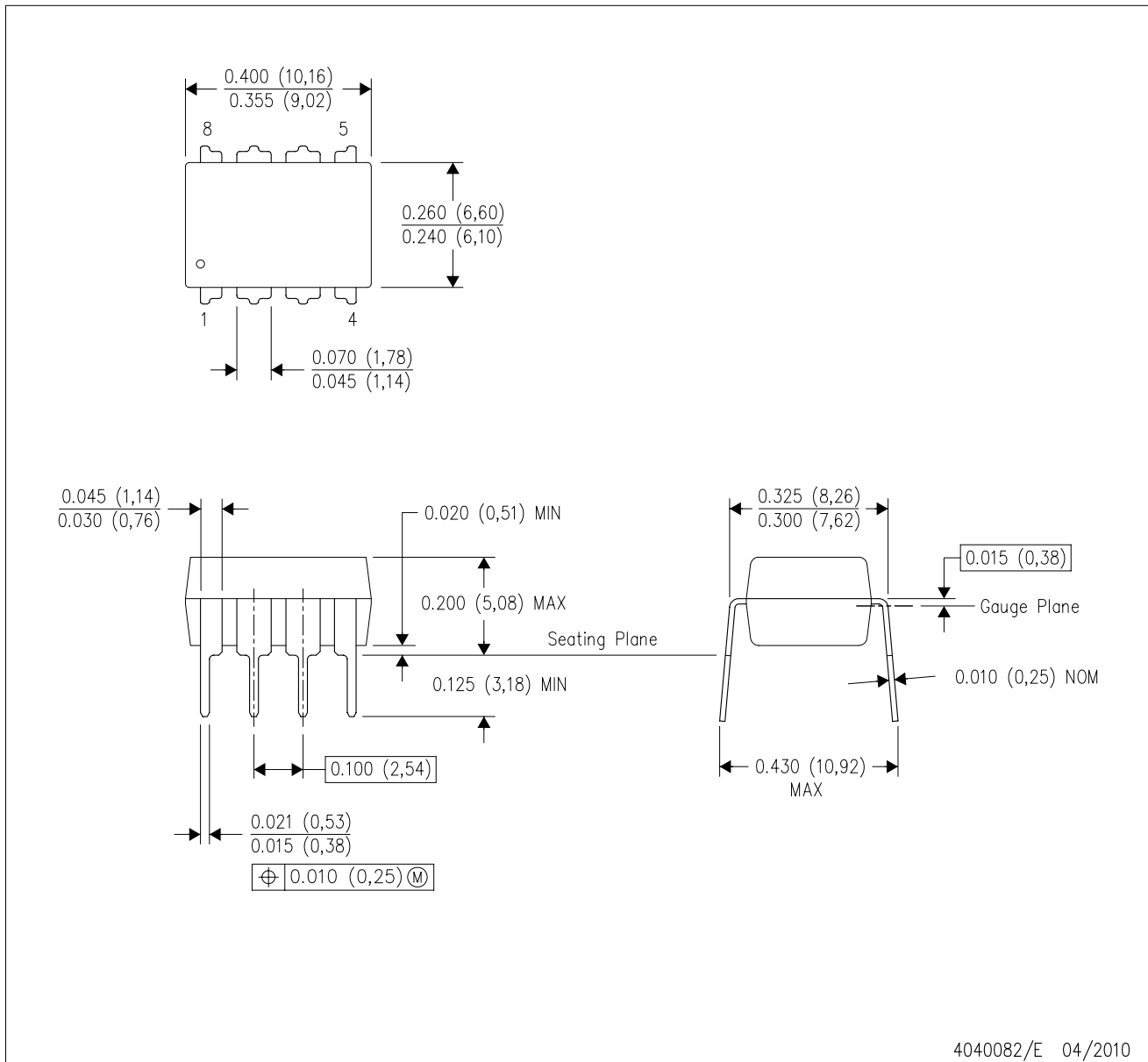

- NOTES:
- All linear dimensions are in inches (millimeters).
 - This drawing is subject to change without notice.
 - Falls within JEDEC MS-001 variation BA.

MECHANICAL DATA

N (R-PDIP-T)**

PLASTIC DUAL-IN-LINE PACKAGE

16 PINS SHOWN

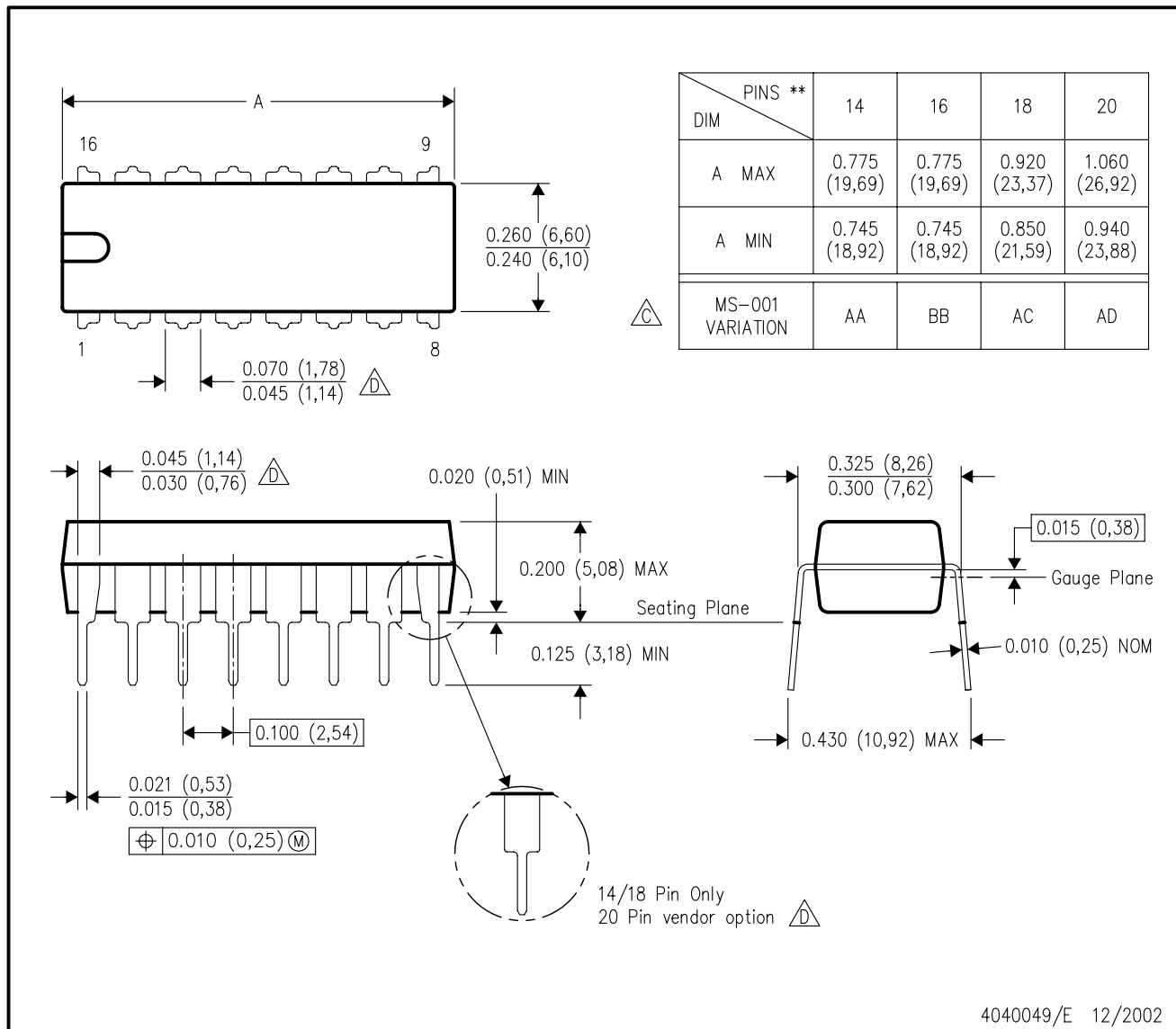

- NOTES:
- A. All linear dimensions are in inches (millimeters).
 - B. This drawing is subject to change without notice.
 - Falls within JEDEC MS-001, except 18 and 20 pin minimum body length (Dim A).
 - The 20 pin end lead shoulder width is a vendor option, either half or full width.



DBV0006A

PACKAGE OUTLINE

SOT-23 - 1.45 mm max height

SMALL OUTLINE TRANSISTOR

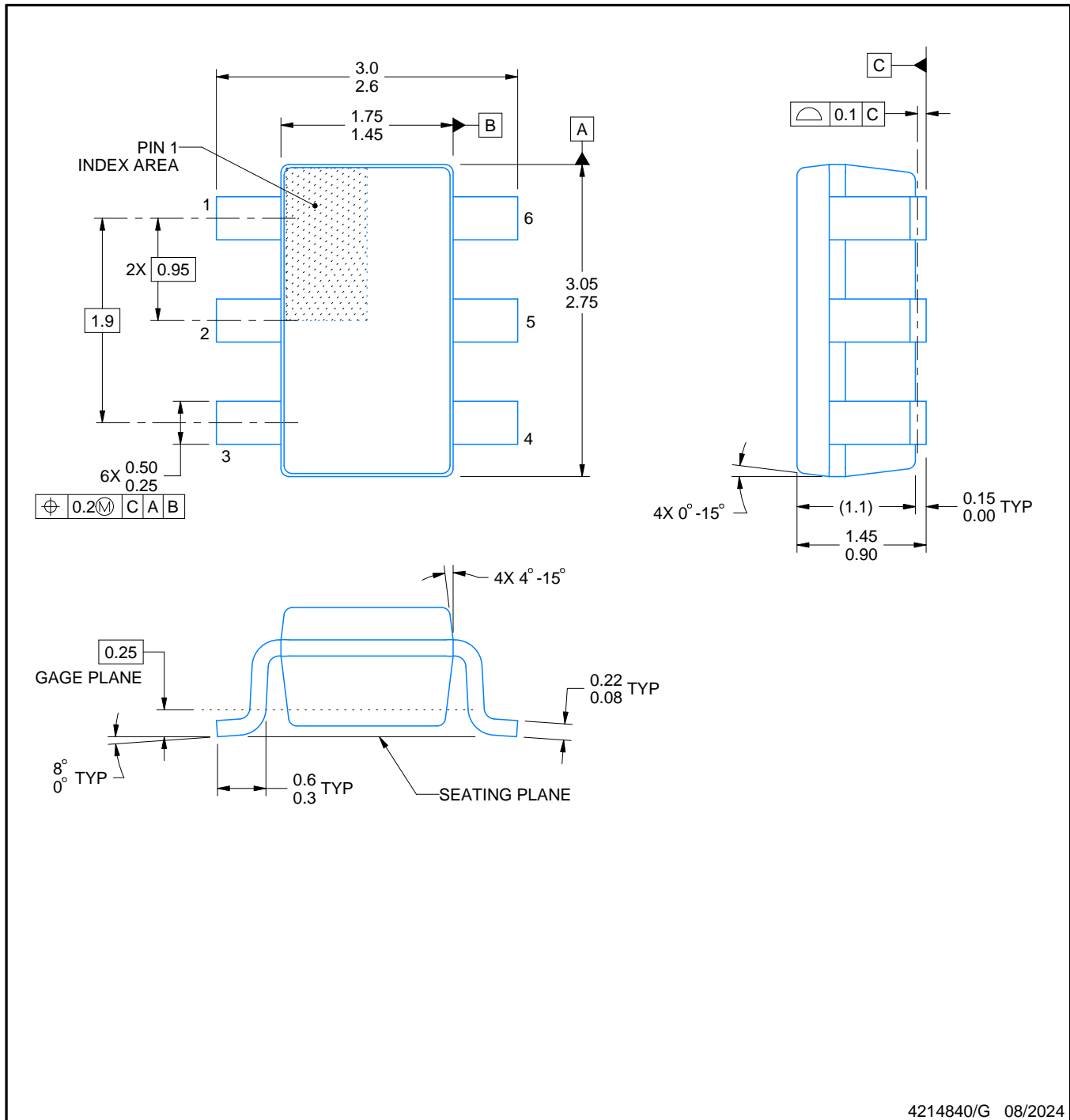

4214840/G 08/2024

NOTES:

- All linear dimensions are in millimeters. Any dimensions in parenthesis are for reference only. Dimensioning and tolerancing per ASME Y14.5M.
- This drawing is subject to change without notice.
- Body dimensions do not include mold flash or protrusion. Mold flash and protrusion shall not exceed 0.25 per side.
- Leads 1,2,3 may be wider than leads 4,5,6 for package orientation.
- Reference JEDEC MO-178.

EXAMPLE BOARD LAYOUT

DBV0006A

SOT-23 - 1.45 mm max height

SMALL OUTLINE TRANSISTOR

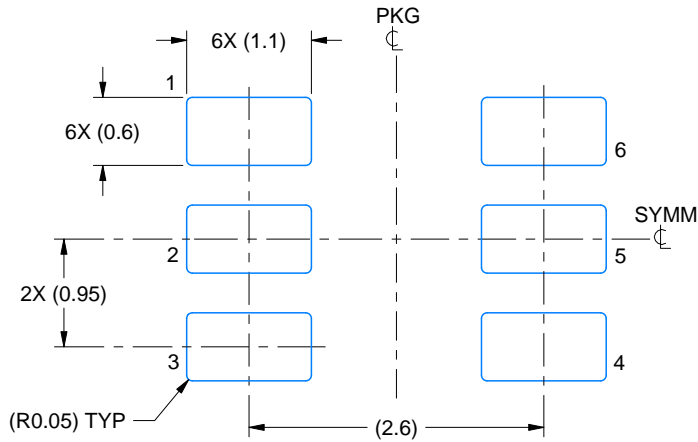

LAND PATTERN EXAMPLE
EXPOSED METAL SHOWN
SCALE:15X

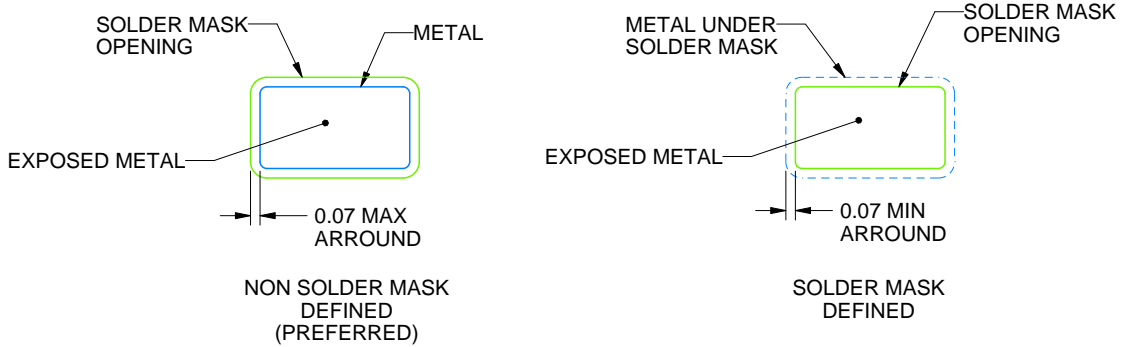

SOLDER MASK DETAILS

4214840/G 08/2024

NOTES: (continued)

- 6. Publication IPC-7351 may have alternate designs.
- 7. Solder mask tolerances between and around signal pads can vary based on board fabrication site.

EXAMPLE STENCIL DESIGN**DBV0006A****SOT-23 - 1.45 mm max height**

SMALL OUTLINE TRANSISTOR

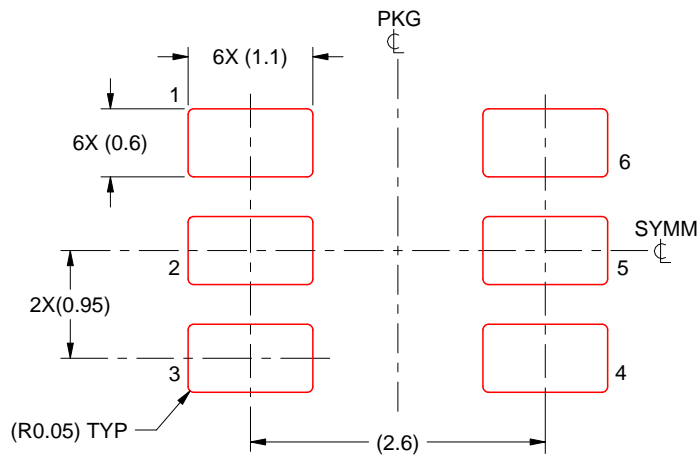

SOLDER PASTE EXAMPLE
 BASED ON 0.125 mm THICK STENCIL
 SCALE:15X

4214840/G 08/2024

NOTES: (continued)

8. Laser cutting apertures with trapezoidal walls and rounded corners may offer better paste release. IPC-7525 may have alternate design recommendations.
9. Board assembly site may have different recommendations for stencil design.

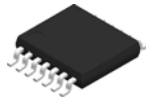

PW0014A

PACKAGE OUTLINE

TSSOP - 1.2 mm max height

SMALL OUTLINE PACKAGE

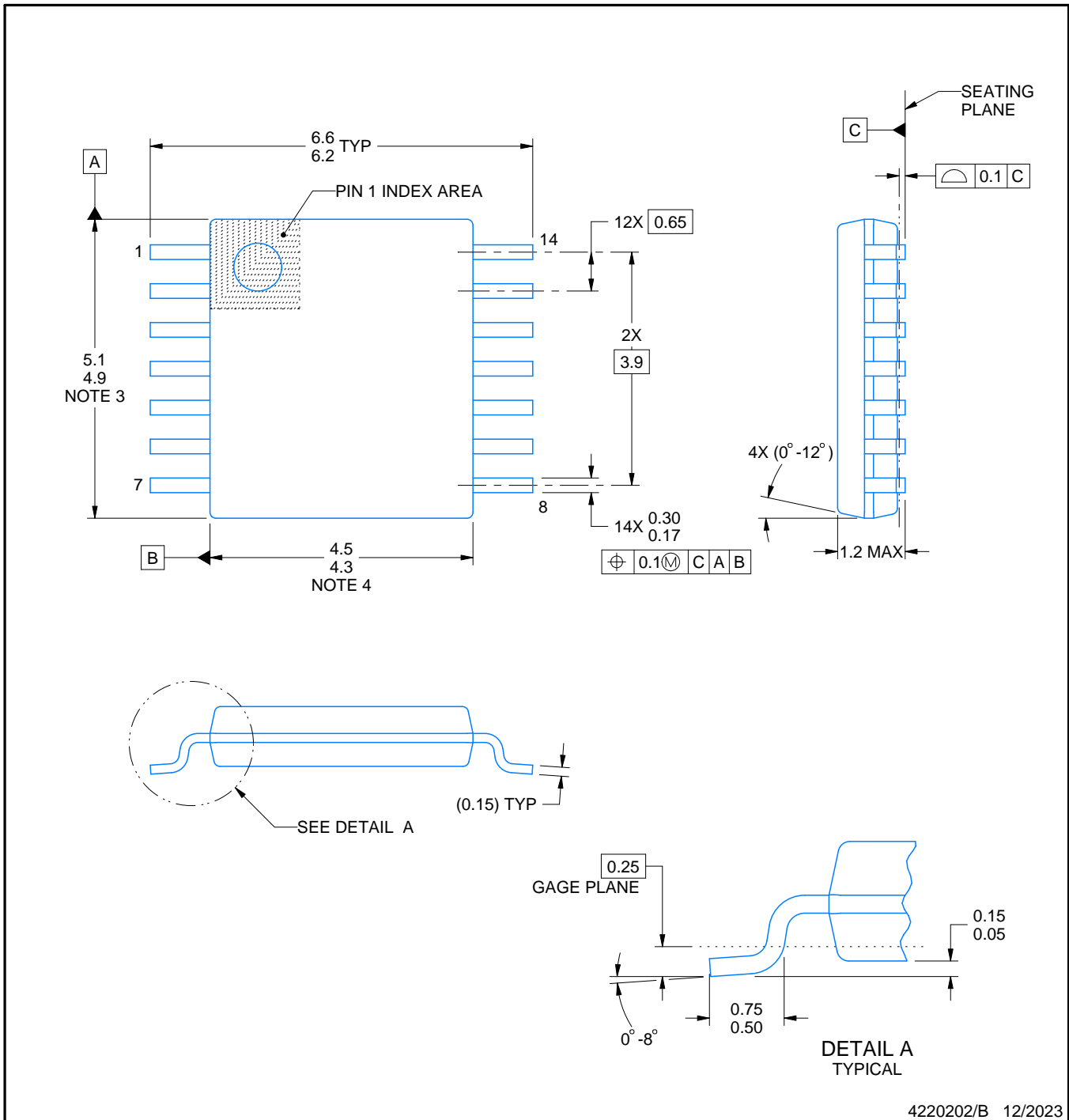

4220202/B 12/2023

NOTES:

1. All linear dimensions are in millimeters. Any dimensions in parenthesis are for reference only. Dimensioning and tolerancing per ASME Y14.5M.
2. This drawing is subject to change without notice.
3. This dimension does not include mold flash, protrusions, or gate burrs. Mold flash, protrusions, or gate burrs shall not exceed 0.15 mm per side.
4. This dimension does not include interlead flash. Interlead flash shall not exceed 0.25 mm per side.
5. Reference JEDEC registration MO-153.

EXAMPLE BOARD LAYOUT

PW0014A

TSSOP - 1.2 mm max height

SMALL OUTLINE PACKAGE

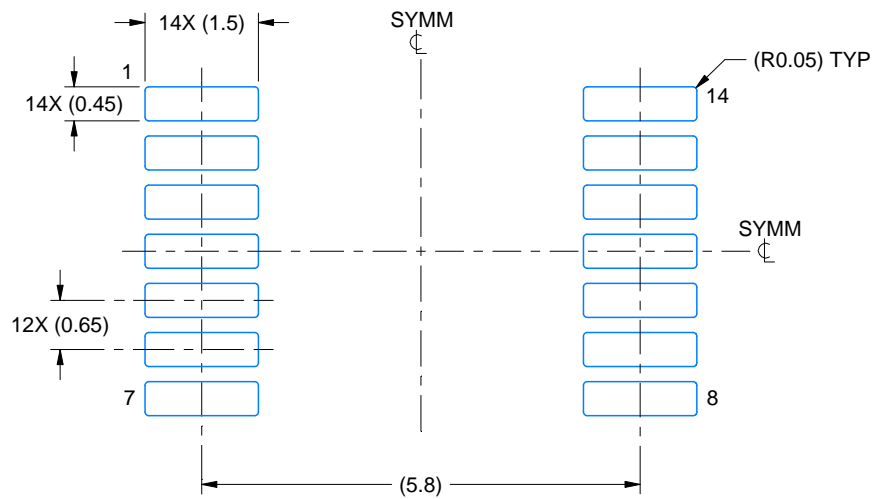

LAND PATTERN EXAMPLE
EXPOSED METAL SHOWN
SCALE: 10X

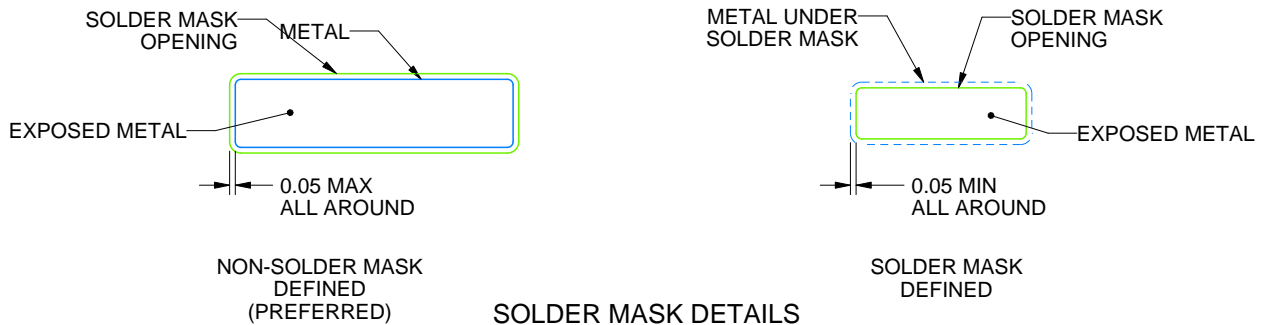

4220202/B 12/2023

NOTES: (continued)

- 6. Publication IPC-7351 may have alternate designs.
- 7. Solder mask tolerances between and around signal pads can vary based on board fabrication site.

EXAMPLE STENCIL DESIGN

PW0014A

TSSOP - 1.2 mm max height

SMALL OUTLINE PACKAGE

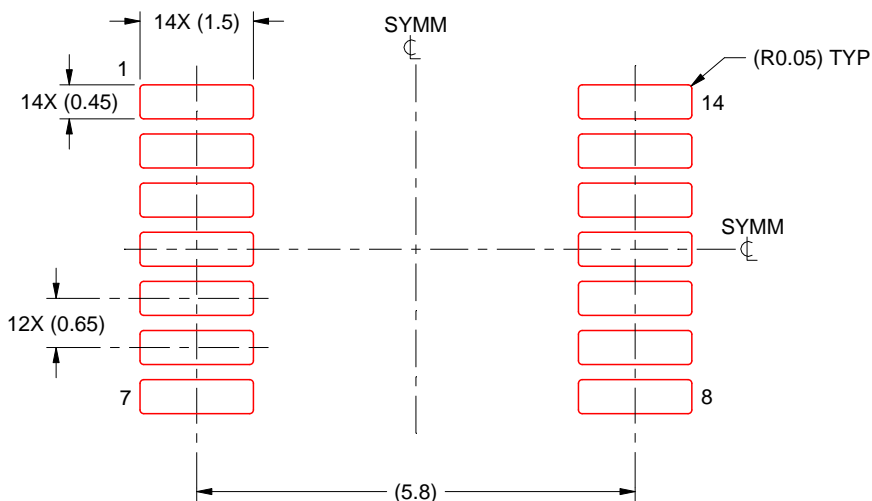

SOLDER PASTE EXAMPLE
 BASED ON 0.125 mm THICK STENCIL
 SCALE: 10X

4220202/B 12/2023

NOTES: (continued)

- 8. Laser cutting apertures with trapezoidal walls and rounded corners may offer better paste release. IPC-7525 may have alternate design recommendations.
- 9. Board assembly site may have different recommendations for stencil design.

EXAMPLE BOARD LAYOUT

DBV0005A

SOT-23 - 1.45 mm max height

SMALL OUTLINE TRANSISTOR

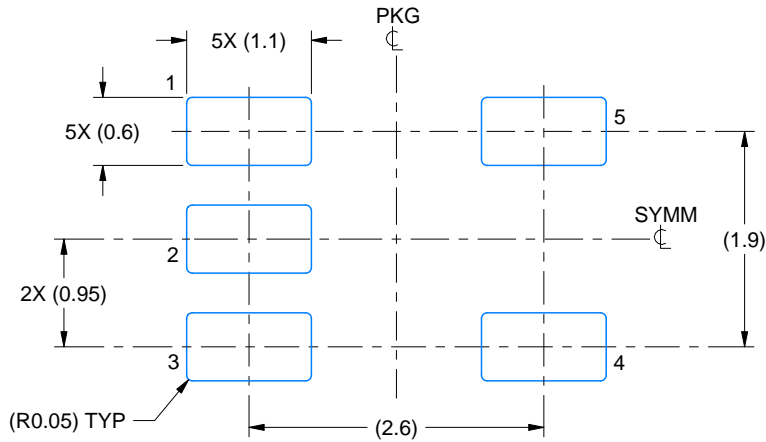

LAND PATTERN EXAMPLE
EXPOSED METAL SHOWN
SCALE:15X

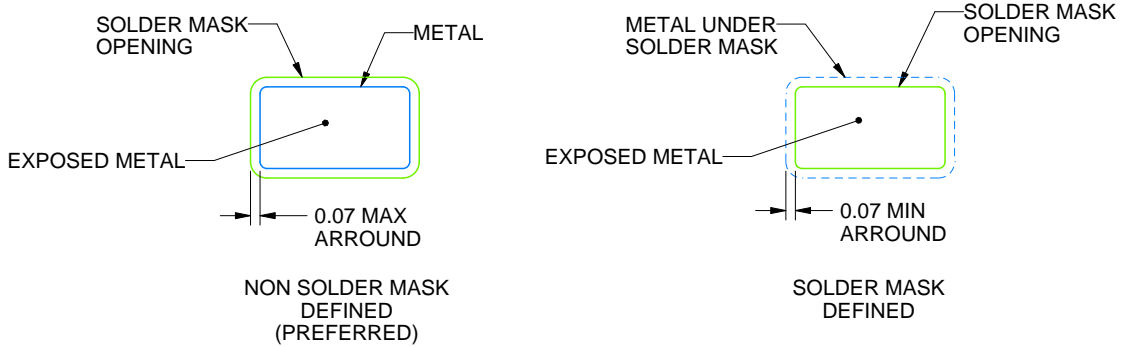

SOLDER MASK DETAILS

4214839/K 08/2024

NOTES: (continued)

- 6. Publication IPC-7351 may have alternate designs.
- 7. Solder mask tolerances between and around signal pads can vary based on board fabrication site.

EXAMPLE STENCIL DESIGN

DBV0005A

SOT-23 - 1.45 mm max height

SMALL OUTLINE TRANSISTOR

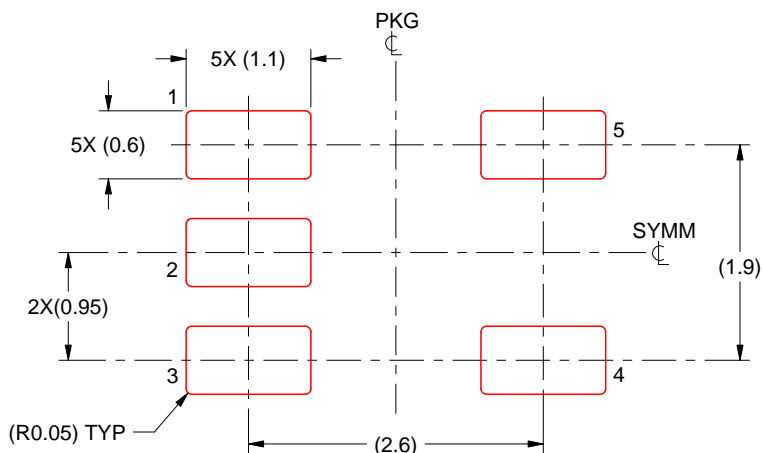

SOLDER PASTE EXAMPLE
 BASED ON 0.125 mm THICK STENCIL
 SCALE:15X

4214839/K 08/2024

NOTES: (continued)

- 8. Laser cutting apertures with trapezoidal walls and rounded corners may offer better paste release. IPC-7525 may have alternate design recommendations.
- 9. Board assembly site may have different recommendations for stencil design.

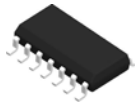

D0014A

PACKAGE OUTLINE

SOIC - 1.75 mm max height

SMALL OUTLINE INTEGRATED CIRCUIT

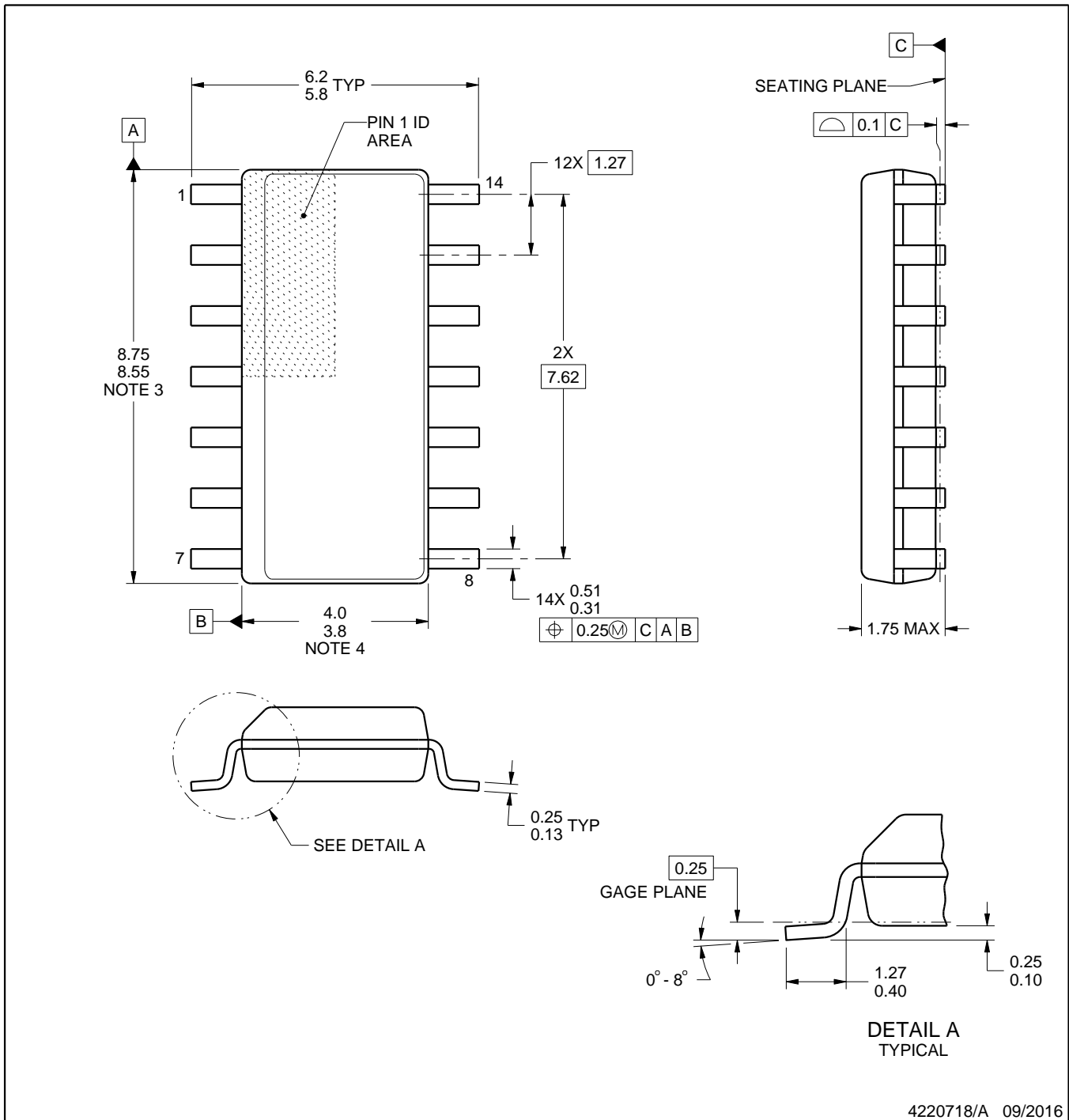

4220718/A 09/2016

NOTES:

1. All linear dimensions are in millimeters. Dimensions in parenthesis are for reference only. Dimensioning and tolerancing per ASME Y14.5M.
2. This drawing is subject to change without notice.
3. This dimension does not include mold flash, protrusions, or gate burrs. Mold flash, protrusions, or gate burrs shall not exceed 0.15 mm, per side.
4. This dimension does not include interlead flash. Interlead flash shall not exceed 0.43 mm, per side.
5. Reference JEDEC registration MS-012, variation AB.

EXAMPLE STENCIL DESIGN**D0014A****SOIC - 1.75 mm max height**

SMALL OUTLINE INTEGRATED CIRCUIT

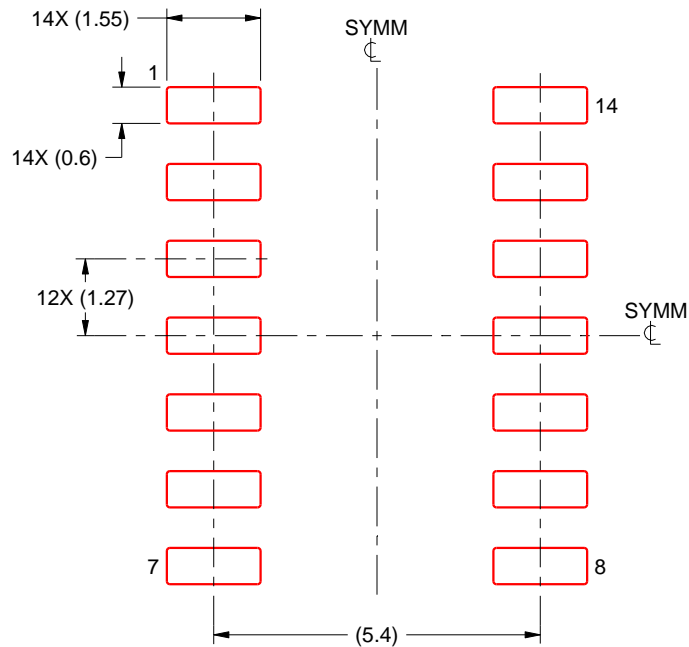

SOLDER PASTE EXAMPLE
 BASED ON 0.125 mm THICK STENCIL
 SCALE:8X

4220718/A 09/2016

NOTES: (continued)

8. Laser cutting apertures with trapezoidal walls and rounded corners may offer better paste release. IPC-7525 may have alternate design recommendations.
9. Board assembly site may have different recommendations for stencil design.

MECHANICAL DATA

D (R-PDSO-G16)

PLASTIC SMALL OUTLINE

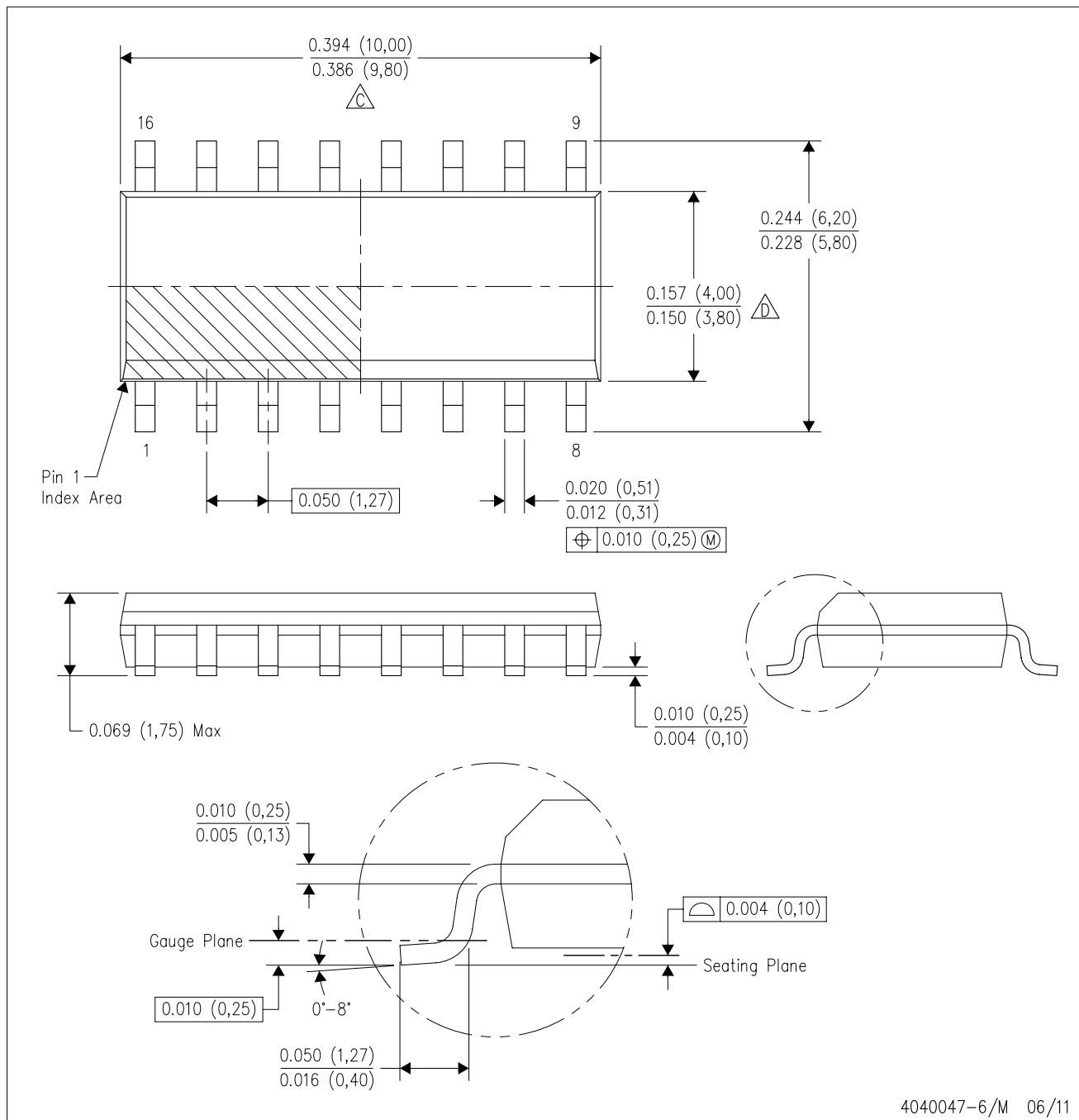

- NOTES:
- A. All linear dimensions are in inches (millimeters).
 - B. This drawing is subject to change without notice.
 - C. Body length does not include mold flash, protrusions, or gate burrs. Mold flash, protrusions, or gate burrs shall not exceed 0.006 (0,15) each side.
 - D. Body width does not include interlead flash. Interlead flash shall not exceed 0.017 (0,43) each side.
 - E. Reference JEDEC MS-012 variation AC.

GENERIC PACKAGE VIEW

PWP 16

PowerPAD™ TSSOP - 1.2 mm max height

PLASTIC SMALL OUTLINE

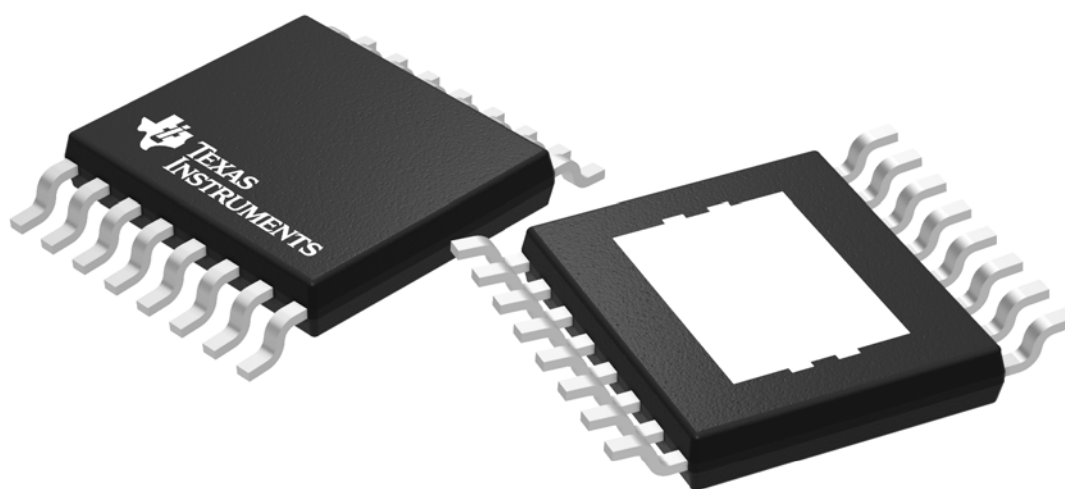

Images above are just a representation of the package family, actual package may vary.
Refer to the product data sheet for package details.

4073225-3/J

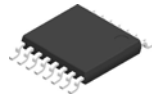

PACKAGE OUTLINE

PWP0016A

PowerPAD™ HTSSOP - 1.2 mm max height

PLASTIC SMALL OUTLINE

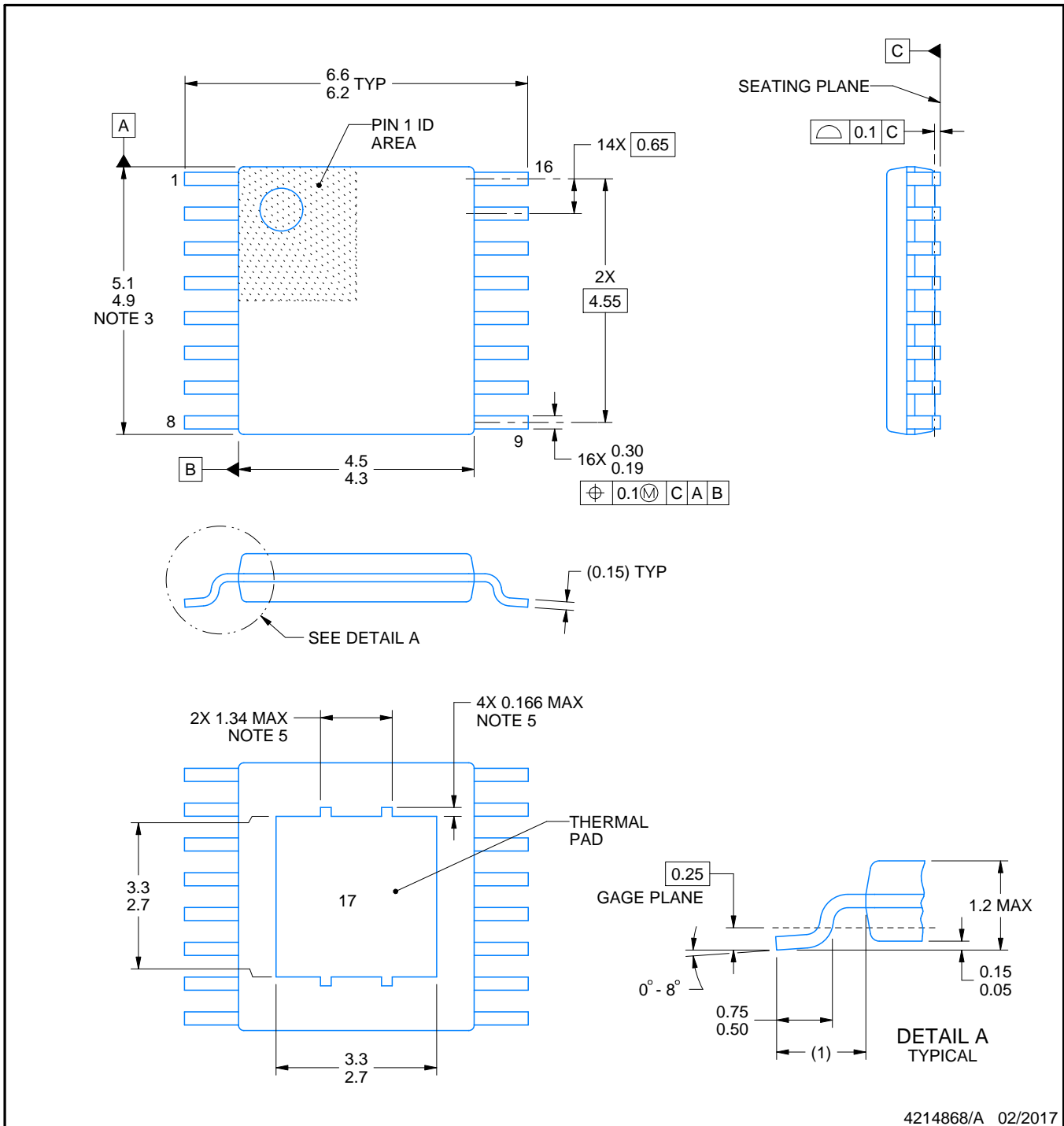

4214868/A 02/2017

NOTES:

PowerPAD is a trademark of Texas Instruments.

1. All linear dimensions are in millimeters. Any dimensions in parenthesis are for reference only. Dimensioning and tolerancing per ASME Y14.5M.
2. This drawing is subject to change without notice.
3. This dimension does not include mold flash, protrusions, or gate burrs. Mold flash, protrusions, or gate burrs shall not exceed 0.15 mm per side.
4. Reference JEDEC registration MO-153.
5. Features may not be present.

EXAMPLE BOARD LAYOUT

PWP0016A

PowerPAD™ HTSSOP - 1.2 mm max height

PLASTIC SMALL OUTLINE

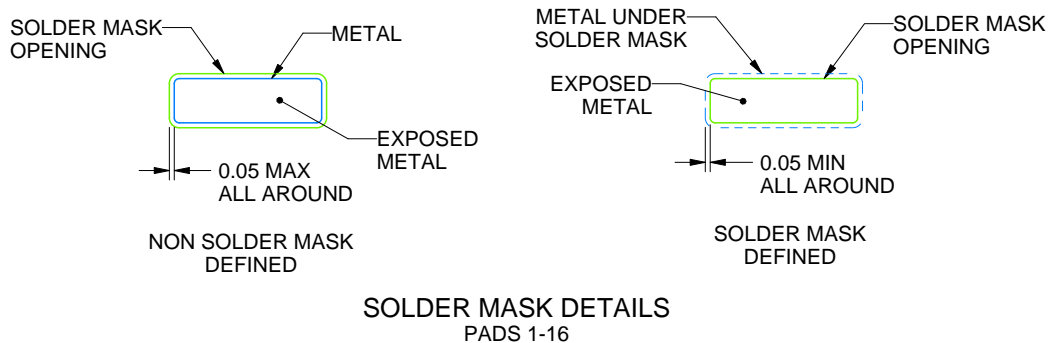
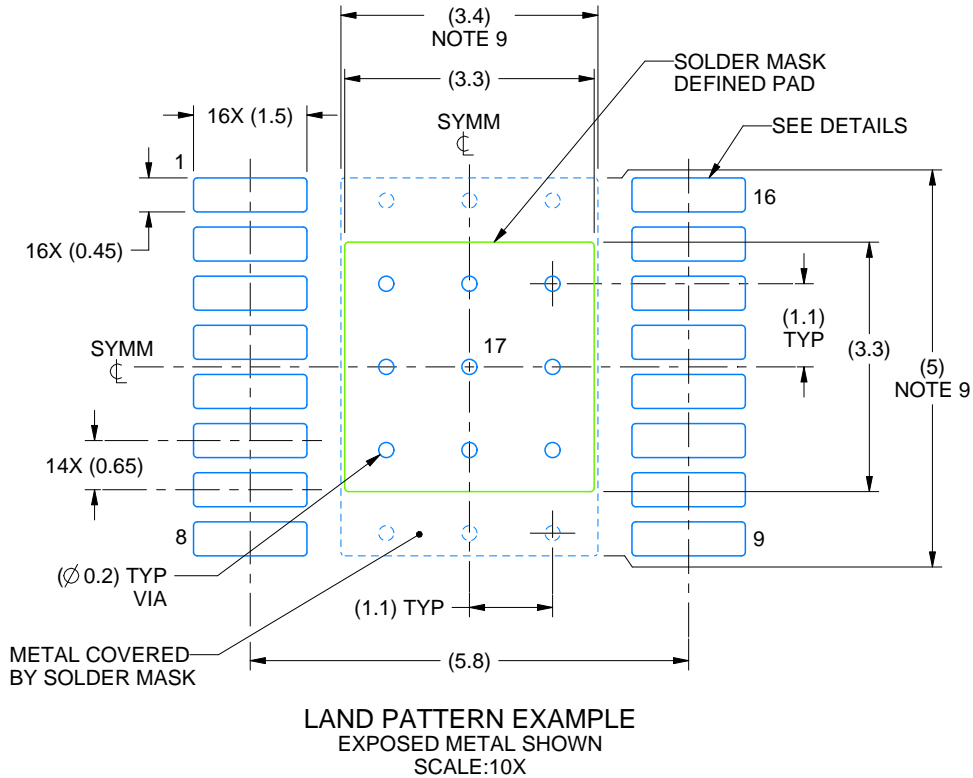

4214868/A 02/2017

NOTES: (continued)

6. Publication IPC-7351 may have alternate designs.
7. Solder mask tolerances between and around signal pads can vary based on board fabrication site.
8. This package is designed to be soldered to a thermal pad on the board. For more information, see Texas Instruments literature numbers SLMA002 (www.ti.com/lit/slma002) and SLMA004 (www.ti.com/lit/slma004).
9. Size of metal pad may vary due to creepage requirement.

EXAMPLE STENCIL DESIGN

PWP0016A

PowerPAD™ HTSSOP - 1.2 mm max height

PLASTIC SMALL OUTLINE

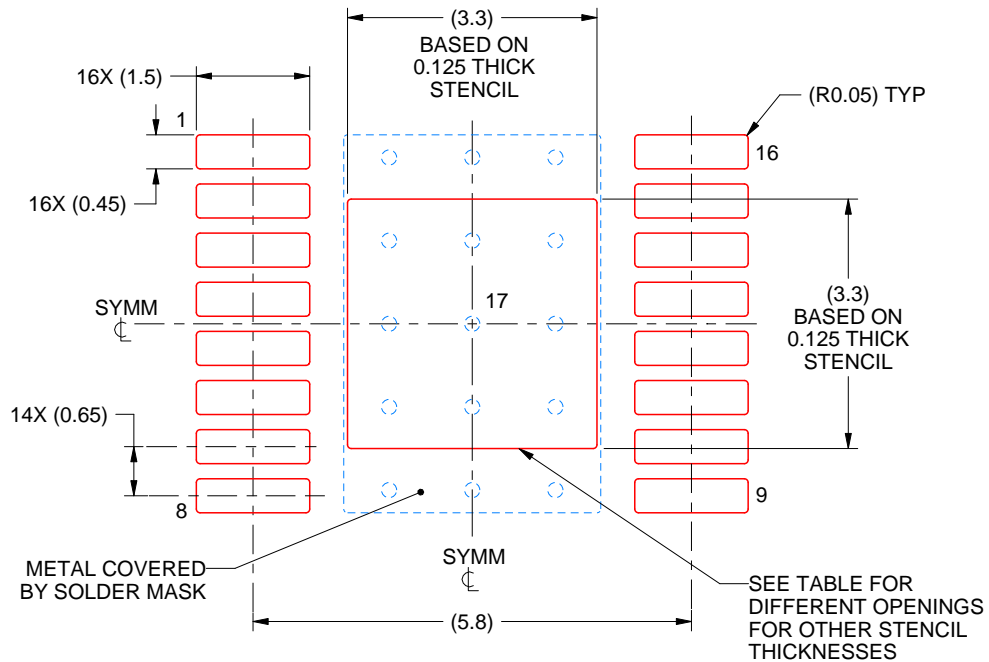

SOLDER PASTE EXAMPLE
 EXPOSED PAD
 100% PRINTED SOLDER COVERAGE BY AREA
 SCALE:10X

| STENCIL THICKNESS | SOLDER STENCIL OPENING |
|-------------------|------------------------|
| 0.1 | 3.69 X 3.69 |
| 0.125 | 3.3 X 3.3 (SHOWN) |
| 0.15 | 3.01 X 3.01 |
| 0.175 | 2.79 X 2.79 |

4214868/A 02/2017

NOTES: (continued)

- 10. Laser cutting apertures with trapezoidal walls and rounded corners may offer better paste release. IPC-7525 may have alternate design recommendations.
- 11. Board assembly site may have different recommendations for stencil design.

IMPORTANT NOTICE AND DISCLAIMER

TI PROVIDES TECHNICAL AND RELIABILITY DATA (INCLUDING DATA SHEETS), DESIGN RESOURCES (INCLUDING REFERENCE DESIGNS), APPLICATION OR OTHER DESIGN ADVICE, WEB TOOLS, SAFETY INFORMATION, AND OTHER RESOURCES "AS IS" AND WITH ALL FAULTS, AND DISCLAIMS ALL WARRANTIES, EXPRESS AND IMPLIED, INCLUDING WITHOUT LIMITATION ANY IMPLIED WARRANTIES OF MERCHANTABILITY, FITNESS FOR A PARTICULAR PURPOSE OR NON-INFRINGEMENT OF THIRD PARTY INTELLECTUAL PROPERTY RIGHTS.

These resources are intended for skilled developers designing with TI products. You are solely responsible for (1) selecting the appropriate TI products for your application, (2) designing, validating and testing your application, and (3) ensuring your application meets applicable standards, and any other safety, security, regulatory or other requirements.

These resources are subject to change without notice. TI grants you permission to use these resources only for development of an application that uses the TI products described in the resource. Other reproduction and display of these resources is prohibited. No license is granted to any other TI intellectual property right or to any third party intellectual property right. TI disclaims responsibility for, and you will fully indemnify TI and its representatives against, any claims, damages, costs, losses, and liabilities arising out of your use of these resources.

TI's products are provided subject to [TI's Terms of Sale](#) or other applicable terms available either on [ti.com](#) or provided in conjunction with such TI products. TI's provision of these resources does not expand or otherwise alter TI's applicable warranties or warranty disclaimers for TI products.

TI objects to and rejects any additional or different terms you may have proposed.

Mailing Address: Texas Instruments, Post Office Box 655303, Dallas, Texas 75265

Copyright © 2025, Texas Instruments Incorporated

OUR CERTIFICATE

DiGi provide top-quality products and perfect service for customer worldwide through standardization, technological innovation and continuous improvement. DiGi through third-party certification, we strictly control the quality of products and services. Welcome your RFQ to

Email: Info@DiGi-Electronics.com



Tel: +00 852-30501935

RFQ Email: Info@DiGi-Electronics.com

DiGi is a global authorized distributor of electronic components.