

TLV9361QDCKRQ1 Datasheet

www.digi-electronics.com

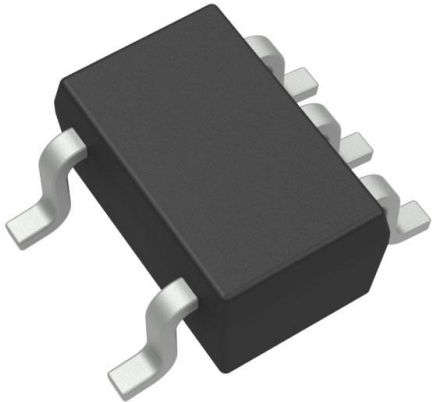

<https://www.DiGi-Electronics.com>

DiGi Electronics Part Number	TLV9361QDCKRQ1-DG
Manufacturer	Texas Instruments
Manufacturer Product Number	TLV9361QDCKRQ1
Description	AUTOMOTIVE, SINGLE, 40-V 10.6-MH
Detailed Description	General Purpose Amplifier 1 Circuit Rail-to-Rail SC-70-5



Tel: +00 852-30501935

RFQ Email: Info@DiGi-Electronics.com

DiGi is a global authorized distributor of electronic components.

Purchase and inquiry

Manufacturer Product Number:

TLV9361QDCKRQ1

Series:

-

Amplifier Type:

General Purpose

Output Type:

Rail-to-Rail

Gain Bandwidth Product:

10.6 MHz

Voltage - Input Offset:

400 μ V

Current - Output / Channel:

60 mA

Voltage - Supply Span (Max):

40 V

Grade:

Automotive

Mounting Type:

Surface Mount

Supplier Device Package:

SC-70-5

Manufacturer:

Texas Instruments

Product Status:

Active

Number of Circuits:

1

Slew Rate:

25V/ μ s

Current - Input Bias:

10 pA

Current - Supply:

2.6mA

Voltage - Supply Span (Min):

4.5 V

Operating Temperature:

-40°C ~ 125°C (TA)

Qualification:

AEC-Q100

Package / Case:

5-TSSOP, SC-70-5, SOT-353

Environmental & Export classification

RoHS Status:

ROHS3 Compliant

REACH Status:

REACH Unaffected

HTSUS:

8542.39.0001

Moisture Sensitivity Level (MSL):

1 (Unlimited)

ECCN:

EAR99

TLV936x-Q1 Automotive, 10MHz, 40V, Rail-to-Rail Output, Operational Amplifier for Cost-Sensitive Systems

1 Features

- AEC-Q100 qualified for automotive applications
 - Temperature grade 1: -40°C to $+125^{\circ}\text{C}$
 - Human-body model (HBM) Electrostatic discharge (ESD) classification level: 2A
 - Charged-device model (CDM) ESD classification level: C6
- Low offset voltage: $\pm 400\mu\text{V}$
- Low offset voltage drift: $\pm 1.25\mu\text{V}/^{\circ}\text{C}$
- Low noise: $8.5\text{nV}/\sqrt{\text{Hz}}$ at 1kHz, $6\text{nV}/\sqrt{\text{Hz}}$ broadband
- High common-mode rejection: 110dB
- Low bias current: $\pm 10\text{pA}$
- Rail-to-rail output
- Wide bandwidth: 10.6MHz GBW, unity-gain stable
- High slew rate: $25\text{V}/\mu\text{s}$
- Low quiescent current: 2.6mA per amplifier
- Wide supply: $\pm 2.25\text{V}$ to $\pm 20\text{V}$, 4.5V to 40V
- Robust EMIRR performance

2 Applications

- [Automotive head unit](#)
- [Digital cockpit processing unit](#)
- [Telematics control unit](#)
- [Emergency call \(eCall\)](#)
- [Automotive active noise cancellation](#)
- [Automotive external amplifier](#)

3 Description

The TLV936x-Q1 family (TLV9361-Q1, TLV9362-Q1, and TLV9364-Q1) is a family of AEC-Q100 automotive qualified, 40V cost-optimized operational amplifiers.

These devices offer strong DC and AC specifications, including rail-to-rail output, low input voltage noise density ($6\text{ nV}/\sqrt{\text{Hz}}$), low offset ($\pm 400\mu\text{V}$, typical), low offset drift ($\pm 1.25\mu\text{V}/^{\circ}\text{C}$, typical), and 10.6MHz bandwidth.

Features such as EMIRR filtering, high output current ($\pm 60\text{mA}$), and high slew rate ($25\text{V}/\mu\text{s}$) make the TLV936x-Q1 a robust operational amplifier for high-voltage, cost-sensitive applications.

The TLV936x-Q1 family of op amps is available in standard packages and is specified from -40°C to 125°C .

Package Information

PART NUMBER ⁽¹⁾	PACKAGE	PACKAGE SIZE ⁽²⁾
TLV9361-Q1	DBV (SOT-23, 5)	2.9mm × 2.8mm
	DCK (SC70, 5)	2mm × 2.1mm
TLV9362-Q1	D (SOIC, 8)	4.9mm × 6mm
	DGK (VSSOP, 8)	3mm × 4.9mm
	PW (TSSOP, 8)	3mm × 6.4mm
TLV9364-Q1	D (SOIC, 14)	8.65mm × 6mm
	PW (TSSOP, 14)	5mm × 6.4mm

(1) For all available packages, see the orderable addendum at the end of the data sheet.

(2) The package size (length × width) is a nominal value and includes pins, where applicable.

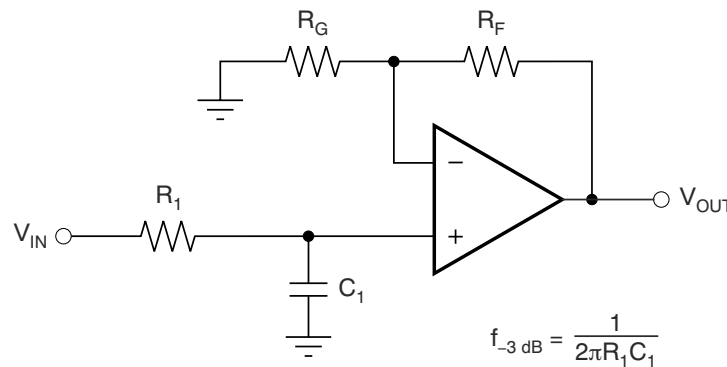

$$\frac{V_{\text{OUT}}}{V_{\text{IN}}} = \left(1 + \frac{R_F}{R_G} \right) \left(\frac{1}{1 + sR_1C_1} \right)$$

TLV936x-Q1 in a Single-Pole, Low-Pass Filter



Table of Contents

1 Features	1	6.4 Device Functional Modes.....	22
2 Applications	1	7 Application and Implementation	23
3 Description	1	7.1 Application Information.....	23
4 Pin Configuration and Functions	3	7.2 Typical Applications.....	23
5 Specifications	6	7.3 Power Supply Recommendations.....	24
5.1 Absolute Maximum Ratings.....	6	7.4 Layout.....	25
5.2 ESD Ratings.....	6	8 Device and Documentation Support	27
5.3 Recommended Operating Conditions.....	6	8.1 Device Support.....	27
5.4 Thermal Information for Single Channel.....	6	8.2 Documentation Support.....	27
5.5 Thermal Information for Dual Channel.....	7	8.3 Receiving Notification of Documentation Updates....	27
5.6 Thermal Information for Quad Channel.....	7	8.4 Support Resources.....	27
5.7 Electrical Characteristics.....	8	8.5 Trademarks.....	27
5.8 Typical Characteristics.....	10	8.6 Electrostatic Discharge Caution.....	28
6 Detailed Description	17	8.7 Glossary.....	28
6.1 Overview.....	17	9 Revision History	28
6.2 Functional Block Diagram.....	17	10 Mechanical, Packaging, and Orderable Information	28
6.3 Feature Description.....	18		

4 Pin Configuration and Functions

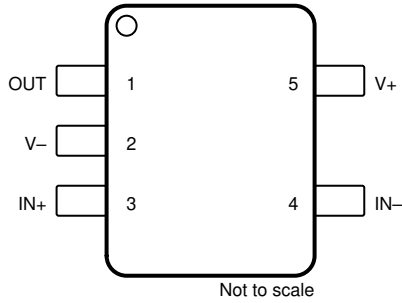

**Figure 4-1. TLV9361-Q1 DBV Package
5-Pin SOT-23
(Top View)**

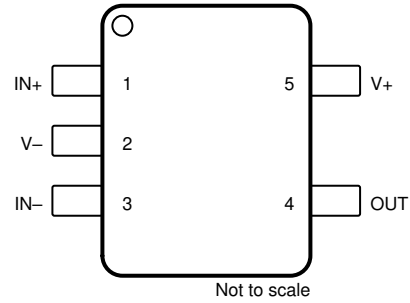

**Figure 4-2. TLV9361-Q1 DCK Package
5-Pin SC70
(Top View)**

Table 4-1. Pin Functions: TLV9361-Q1

NAME	PIN		TYPE ⁽¹⁾	DESCRIPTION
	SOT-23	SC70		
IN+	3	1	I	Non-inverting input
IN-	4	3	I	Inverting input
OUT	1	4	O	Output
V+	5	5	—	Positive (highest) power supply
V-	2	2	—	Negative (lowest) power supply

(1) I = input, O = output

TLV9361-Q1, TLV9362-Q1, TLV9364-Q1

SBOSAD6B – APRIL 2023 – REVISED AUGUST 2024

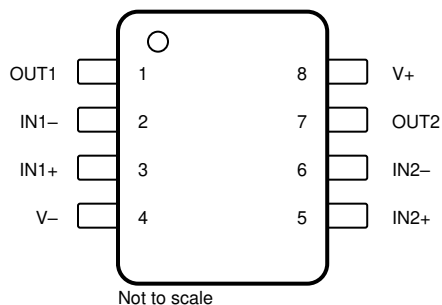
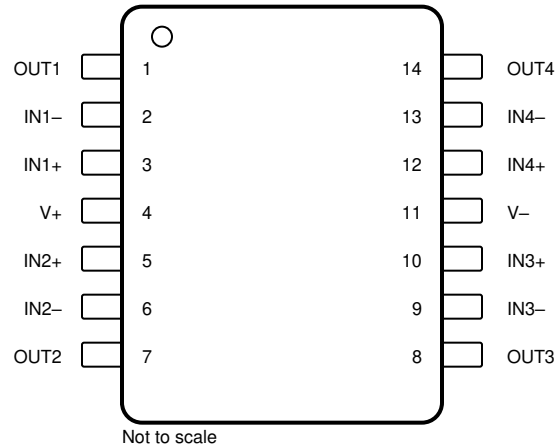

**Figure 4-3. TLV9362-Q1 D, DGK, and PW Package
8-Pin SOIC, VSSOP, and TSSOP
(Top View)**

Table 4-2. Pin Functions: TLV9362-Q1

PIN		TYPE ⁽¹⁾	DESCRIPTION
NAME	NO.		
IN1+	3	I	Non-inverting input, channel 1
IN1-	2	I	Inverting input, channel 1
IN2+	5	I	Non-inverting input, channel 2
IN2-	6	I	Inverting input, channel 2
OUT1	1	O	Output, channel 1
OUT2	7	O	Output, channel 2
V+	8	—	Positive (highest) power supply
V-	4	—	Negative (lowest) power supply

(1) I = input, O = output



**Figure 4-4. TLV9364-Q1 D and PW Package,
SOIC and TSSOP
(Top View)**

Table 4-3. Pin Functions: TLV9364-Q1

PIN		TYPE ⁽¹⁾	DESCRIPTION
NAME	NO.		
IN1+	3	I	Non-inverting input, channel 1
IN1–	2	I	Inverting input, channel 1
IN2+	5	I	Non-inverting input, channel 2
IN2–	6	I	Inverting input, channel 2
IN3+	10	I	Non-inverting input, channel 3
IN3–	9	I	Inverting input, channel 3
IN4+	12	I	Non-inverting input, channel 4
IN4–	13	I	Inverting input, channel 4
OUT1	1	O	Output, channel 1
OUT2	7	O	Output, channel 2
OUT3	8	O	Output, channel 3
OUT4	14	O	Output, channel 4
V+	4	—	Positive (highest) power supply
V–	11	—	Negative (lowest) power supply

(1) I = input, O = output

5 Specifications

5.1 Absolute Maximum Ratings

over operating ambient temperature range (unless otherwise noted)⁽¹⁾

		MIN	MAX	UNIT
Supply voltage, $V_S = (V+) - (V-)$		0	42	V
Signal input pins	Common-mode voltage ⁽³⁾	$(V-) - 0.5$	$(V+) + 0.5$	V
	Differential voltage ⁽³⁾		$V_S + 0.2$	V
	Current ⁽³⁾	-10	10	mA
Output short-circuit ⁽²⁾		Continuous		
Operating ambient temperature, T_A		-55	150	°C
Junction temperature, T_J			150	°C
Storage temperature, T_{stg}		-65	150	°C

- (1) Operating the device beyond the ratings listed under *Absolute Maximum Ratings* causes permanent damage to the device. These are stress ratings only, based on process and design limitations, and this device has not been designed to function outside the conditions indicated under *Recommended Operating Conditions*. Exposure to any condition outside *Recommended Operating Conditions* for extended periods, including absolute-maximum-rated conditions, can affect device reliability and performance.
- (2) Short-circuit to ground, one amplifier per package. Extended short-circuit current, especially with higher supply voltage, can cause excessive heating and eventual destruction.
- (3) Input pins are diode-clamped to the power-supply rails. Input signals that can swing more than 0.5V beyond the supply rails must be current limited to 10mA or less.

5.2 ESD Ratings

			VALUE	UNIT
TLV9361-Q1				
$V_{(ESD)}$	Electrostatic discharge	Human-body model (HBM), per ANSI/ESDA/JEDEC JS-001 ⁽¹⁾	±2000	V
		Charged-device model (CDM), per ANSI/ESDA/JEDEC JS-002 ⁽²⁾	±1500	
TLV9362-Q1 and TLV9364-Q1				
$V_{(ESD)}$	Electrostatic discharge	Human-body model (HBM), per ANSI/ESDA/JEDEC JS-001 ⁽¹⁾	±2500	V
		Charged-device model (CDM), per ANSI/ESDA/JEDEC JS-002 ⁽²⁾	±1500	

- (1) JEDEC document JEP155 states that 500V HBM allows safe manufacturing with a standard ESD control process.
- (2) JEDEC document JEP157 states that 250V CDM allows safe manufacturing with a standard ESD control process.

5.3 Recommended Operating Conditions

over operating ambient temperature range (unless otherwise noted)

		MIN	MAX	UNIT
V_S	Supply voltage, $(V+) - (V-)$	4.5	40	V
V_I	Common mode voltage range	$(V-)$	$(V+) - 2$	V
T_A	Specified temperature	-40	125	°C

5.4 Thermal Information for Single Channel

THERMAL METRIC ⁽¹⁾		TLV9361-Q1		UNIT
		DBV (SOT-23)	DCK (SC70)	
		5 PINS	5 PINS	
$R_{\theta JA}$	Junction-to-ambient thermal resistance	189.3	202.4	°C/W
$R_{\theta JC(top)}$	Junction-to-case (top) thermal resistance	86.8	111.6	°C/W
$R_{\theta JB}$	Junction-to-board thermal resistance	55.9	51.6	°C/W
Ψ_{JT}	Junction-to-top characterization parameter	23.6	25.8	°C/W
Ψ_{JB}	Junction-to-board characterization parameter	55.5	51.4	°C/W

THERMAL METRIC ⁽¹⁾		TLV9361-Q1		UNIT
		DBV (SOT-23)	DCK (SC70)	
		5 PINS	5 PINS	
$R_{\theta JC(bot)}$	Junction-to-case (bottom) thermal resistance	N/A	N/A	°C/W

- (1) For more information about traditional and new thermal metrics, see the *Semiconductor and IC Package Thermal Metrics* application report, [SPRA953](#).

5.5 Thermal Information for Dual Channel

THERMAL METRIC ⁽¹⁾		TLV9362-Q1			Unit
		D (SOIC)	DGK (VSSOP)	PW (TSSOP)	
		8 PINS	8 PINS	8 PINS	
$R_{\theta JA}$	Junction-to-ambient thermal resistance	130.8	173.9	159.1	°C/W
$R_{\theta JC(top)}$	Junction-to-case (top) thermal resistance	74.0	65.7	67.9	°C/W
$R_{\theta JB}$	Junction-to-board thermal resistance	74.3	95.6	98.1	°C/W
ψ_{JT}	Junction-to-top characterization parameter	25.8	10.9	9.1	°C/W
ψ_{JB}	Junction-to-board characterization parameter	73.5	94.1	96.7	°C/W
$R_{\theta JC(bot)}$	Junction-to-case (bottom) thermal resistance	N/A	N/A	N/A	°C/W

- (1) For more information about traditional and new thermal metrics, see the *Semiconductor and IC Package Thermal Metrics* application report, [SPRA953](#).

5.6 Thermal Information for Quad Channel

THERMAL METRIC ⁽¹⁾		TLV9364-Q1		UNIT
		D (SOIC)	PW (TSSOP)	
		14 PINS	14 PINS	
$R_{\theta JA}$	Junction-to-ambient thermal resistance	94.9	120.0	°C/W
$R_{\theta JC(top)}$	Junction-to-case (top) thermal resistance	51.1	50.4	°C/W
$R_{\theta JB}$	Junction-to-board thermal resistance	51.4	63.1	°C/W
ψ_{JT}	Junction-to-top characterization parameter	15.3	8.1	°C/W
ψ_{JB}	Junction-to-board characterization parameter	51.0	62.5	°C/W
$R_{\theta JC(bot)}$	Junction-to-case (bottom) thermal resistance	N/A	N/A	°C/W

- (1) For more information about traditional and new thermal metrics, see the *Semiconductor and IC Package Thermal Metrics* application report, [SPRA953](#).

TLV9361-Q1, TLV9362-Q1, TLV9364-Q1

SBOSAD6B – APRIL 2023 – REVISED AUGUST 2024

5.7 Electrical Characteristics

For $V_S = (V+) - (V-) = 4.5\text{ V to }40\text{ V}$ ($\pm 2.25\text{ V to } \pm 20\text{ V}$) at $T_A = 25^\circ\text{C}$, $R_L = 10\text{ k}\Omega$ connected to $V_S / 2$, $V_{CM} = V_S / 2$, and $V_{OUT} = V_S / 2$, unless otherwise noted.

PARAMETER		TEST CONDITIONS		MIN	TYP	MAX	UNIT
OFFSET VOLTAGE							
V_{OS}	Input offset voltage	$V_{CM} = V-$			± 0.4	± 1.7	mV
			$T_A = -40^\circ\text{C to }125^\circ\text{C}$			± 2	
dV_{OS}/dT	Input offset voltage drift	$V_{CM} = V-$	$T_A = -40^\circ\text{C to }125^\circ\text{C}$		± 1.25		$\mu\text{V}/^\circ\text{C}$
PSRR	Input offset voltage versus power supply	$V_{CM} = V-, V_S = 5\text{ V to }40\text{ V}^{(1)}$	$T_A = -40^\circ\text{C to }125^\circ\text{C}$		± 1.5	± 7.5	$\mu\text{V/V}$
	DC channel separation				1		$\mu\text{V/V}$
INPUT BIAS CURRENT							
I_B	Input bias current				± 10		pA
I_{OS}	Input offset current				± 10		pA
NOISE							
E_N	Input voltage noise	$f = 0.1\text{ Hz to }10\text{ Hz}$			6		μV_{PP}
					1		μV_{RMS}
e_N	Input voltage noise density	$f = 1\text{ kHz}$			8.5		$\text{nV}/\sqrt{\text{Hz}}$
		$f = 10\text{ kHz}$			6		
i_N	Input current noise density	$f = 1\text{ kHz}$			100		$\text{fA}/\sqrt{\text{Hz}}$
INPUT VOLTAGE RANGE							
V_{CM}	Common-mode voltage range			(V-)		(V+) - 2	V
CMRR	Common-mode rejection ratio	$V_S = 40\text{ V}, V- < V_{CM} < (V+) - 2\text{ V}$	$T_A = -40^\circ\text{C to }125^\circ\text{C}$		95	110	dB
		$V_S = 5\text{ V}, V- < V_{CM} < (V+) - 2\text{ V}^{(1)}$			75	85	
INPUT IMPEDANCE							
Z_{ID}	Differential				$100 \parallel 9$		$\text{M}\Omega \parallel \text{pF}$
Z_{ICM}	Common-mode				$6 \parallel 1$		$\text{T}\Omega \parallel \text{pF}$
OPEN-LOOP GAIN							
A_{OL}	Open-loop voltage gain	$V_S = 40\text{ V}, V_{CM} = V_S / 2, (V-) + 0.1\text{ V} < V_O < (V+) - 0.1\text{ V}$	$T_A = -40^\circ\text{C to }125^\circ\text{C}$		115	130	dB
		$V_S = 40\text{ V}, V_{CM} = V_S / 2, (V-) + 0.12\text{ V} < V_O < (V+) - 0.12\text{ V}$				130	
		$V_S = 5\text{ V}, V_{CM} = V_S / 2, (V-) + 0.1\text{ V} < V_O < (V+) - 0.1\text{ V}^{(1)}$			100	120	
			$T_A = -40^\circ\text{C to }125^\circ\text{C}$			120	
FREQUENCY RESPONSE							
GBW	Gain-bandwidth product				10.6		MHz
SR	Slew rate	$V_S = 40\text{ V}, G = +1, V_{STEP} = 10\text{ V}, C_L = 20\text{ pF}^{(3)}$			25		V/ μs
t_S	Settling time	To 0.1%, $V_S = 40\text{ V}, V_{STEP} = 10\text{ V}, G = +1, C_L = 20\text{ pF}$			0.65		μs
		To 0.1%, $V_S = 40\text{ V}, V_{STEP} = 2\text{ V}, G = +1, C_L = 20\text{ pF}$			0.3		
		To 0.01%, $V_S = 40\text{ V}, V_{STEP} = 10\text{ V}, G = +1, C_L = 20\text{ pF}$			0.86		
		To 0.01%, $V_S = 40\text{ V}, V_{STEP} = 2\text{ V}, G = +1, C_L = 20\text{ pF}$			0.44		
	Phase margin	$G = +1, R_L = 10\text{ k}\Omega, C_L = 20\text{ pF}$			64		$^\circ$
	Overload recovery time	$V_{IN} \times \text{gain} > V_S$			170		ns
THD+N	Total harmonic distortion + noise	$V_S = 40\text{ V}, V_O = 3\text{ V}_{RMS}, G = 1, f = 1\text{ kHz}, R_L = 10\text{ k}\Omega$			0.0001%		dB
					120		
		$V_S = 10\text{ V}, V_O = 3\text{ V}_{RMS}, G = 1, f = 1\text{ kHz}, R_L = 128\text{ }\Omega$			0.0056%		dB
					85		
		$V_S = 10\text{ V}, V_O = 0.4\text{ V}_{RMS}, G = 1, f = 1\text{ kHz}, R_L = 32\text{ }\Omega$			0.00056%		dB
					105		

For $V_S = (V+) - (V-) = 4.5 \text{ V to } 40 \text{ V}$ ($\pm 2.25 \text{ V to } \pm 20 \text{ V}$) at $T_A = 25^\circ\text{C}$, $R_L = 10 \text{ k}\Omega$ connected to $V_S / 2$, $V_{CM} = V_S / 2$, and $V_{OUT} = V_S / 2$, unless otherwise noted.

PARAMETER		TEST CONDITIONS		MIN	TYP	MAX	UNIT
OUTPUT							
	Voltage output swing from rail	Positive and negative rail headroom	$V_S = 40 \text{ V}$, $R_L = \text{no load}$	10		100	mV
			$V_S = 40 \text{ V}$, $R_L = 10 \text{ k}\Omega$	60			
			$V_S = 40 \text{ V}$, $R_L = 2 \text{ k}\Omega$	250			
I_{SC}	Short-circuit current			$\pm 60^{(2)}$			mA
C_{LOAD}	Capacitive Load Drive			See Figure 5-28			pF
Z_O	Open-loop output impedance	$I_O = 0 \text{ A}$		See Figure 5-25			Ω
POWER SUPPLY							
I_Q	Quiescent current per amplifier	$I_O = 0 \text{ A}$		2.6		3	mA
			$T_A = -40^\circ\text{C to } 125^\circ\text{C}$			3.2	

- (1) Specified by characterization only.
- (2) At high supply voltage, placing the TLV936x in a sudden short to mid-supply or ground will lead to rapid thermal shutdown. Output current greater than I_{SC} can be achieved if rapid thermal shutdown is avoided as per [Figure 5-12](#).
- (3) See [Figure 5-11](#) for more information.

5.8 Typical Characteristics

at $T_A = 25^\circ\text{C}$, $V_S = \pm 20\text{V}$, $V_{CM} = V_S / 2$, $R_{LOAD} = 10\text{k}\Omega$ (unless otherwise noted)

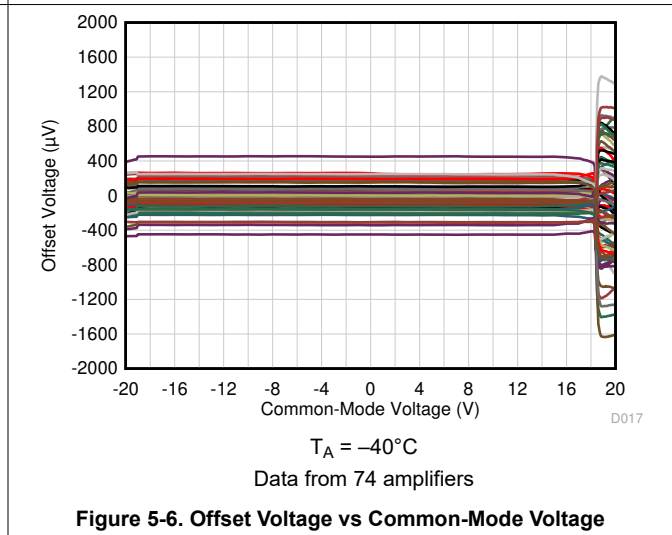
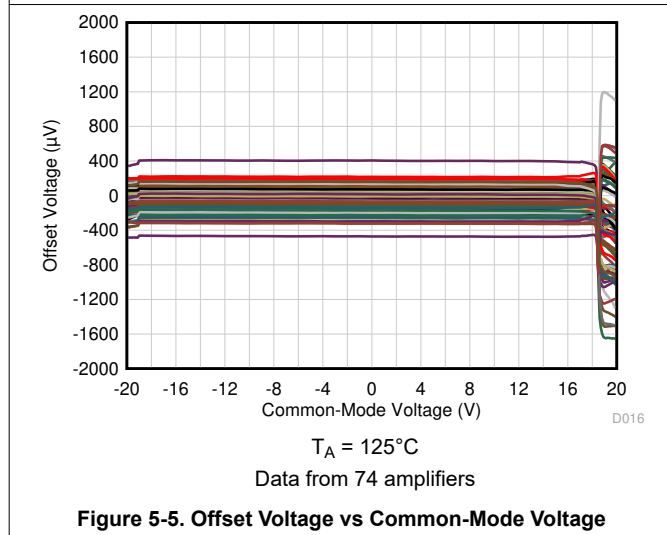
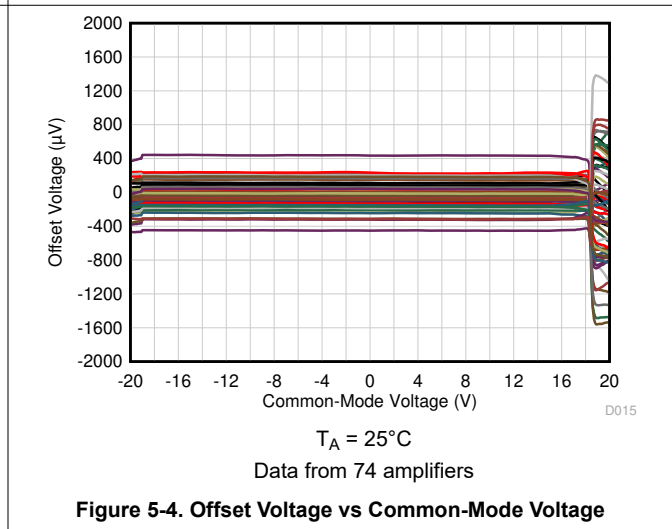
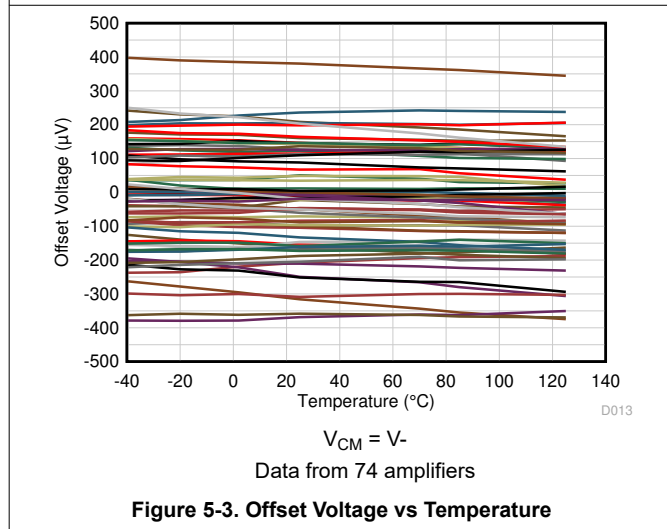
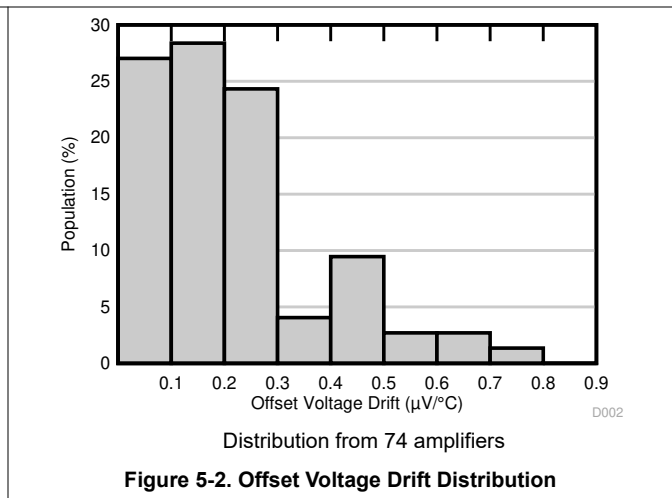
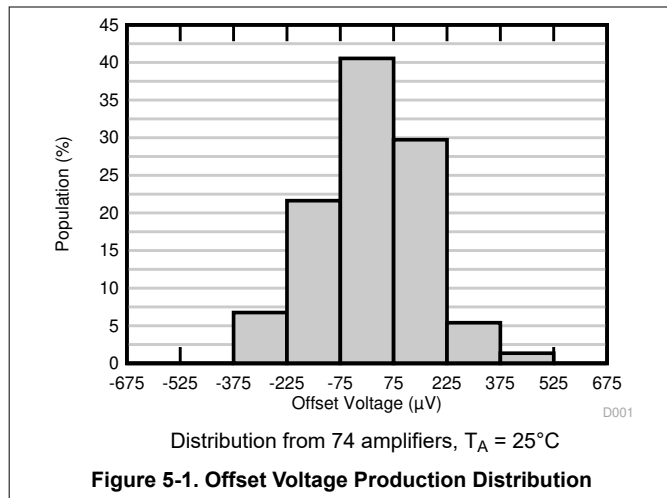

5.8 Typical Characteristics (continued)

at $T_A = 25^\circ\text{C}$, $V_S = \pm 20\text{V}$, $V_{CM} = V_S / 2$, $R_{LOAD} = 10\text{k}\Omega$ (unless otherwise noted)

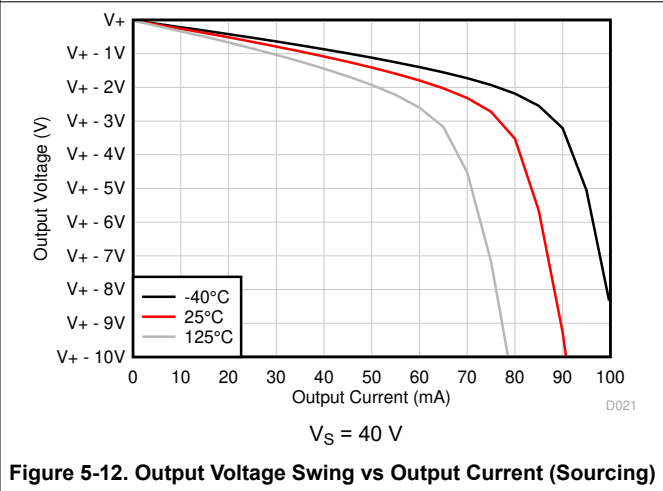
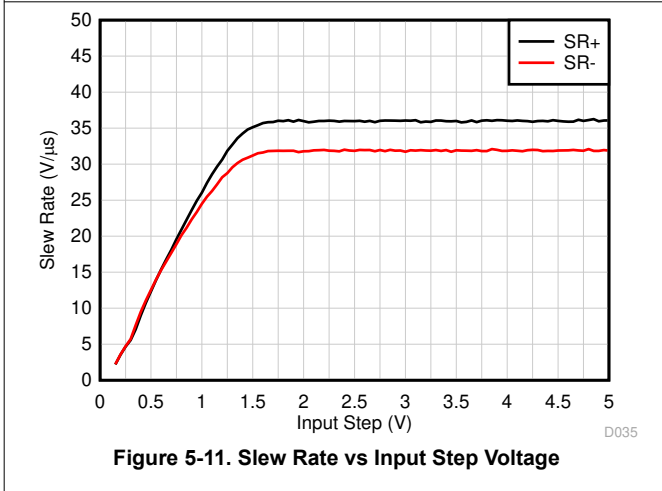
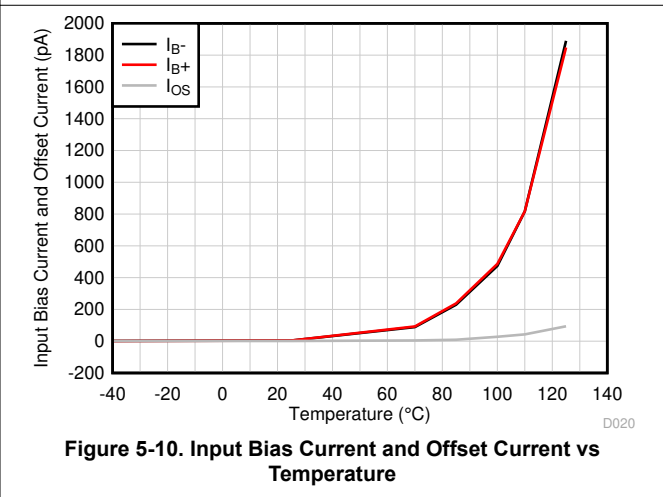
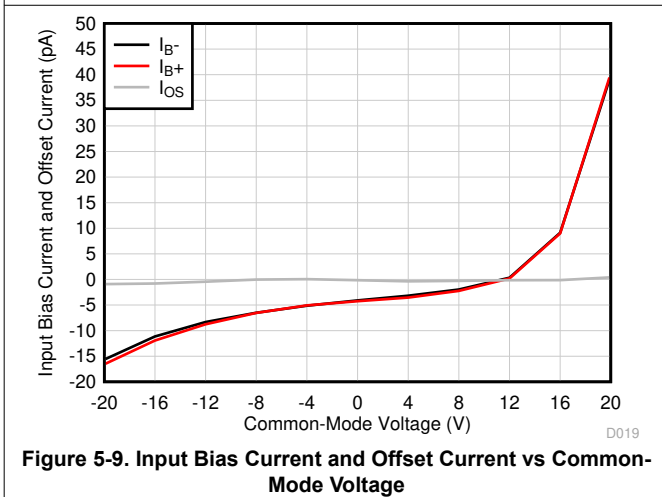
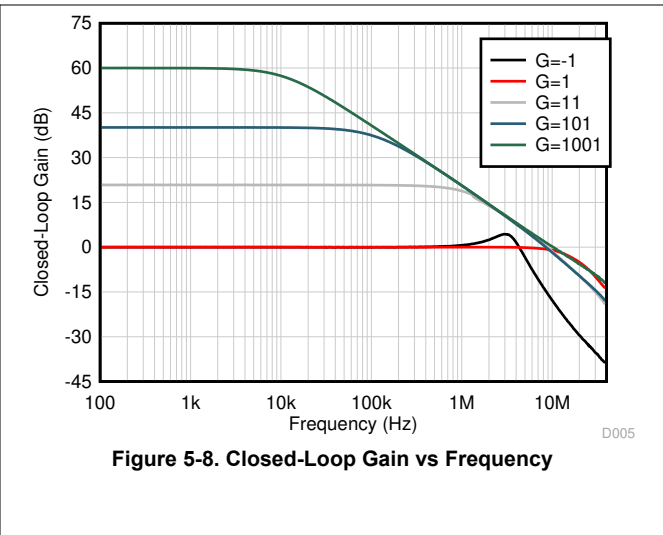
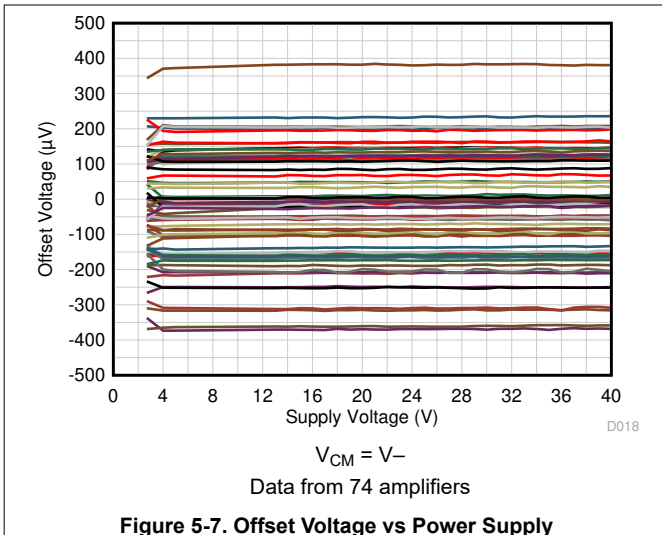

5.8 Typical Characteristics (continued)

at $T_A = 25^\circ\text{C}$, $V_S = \pm 20\text{V}$, $V_{CM} = V_S / 2$, $R_{LOAD} = 10\text{k}\Omega$ (unless otherwise noted)

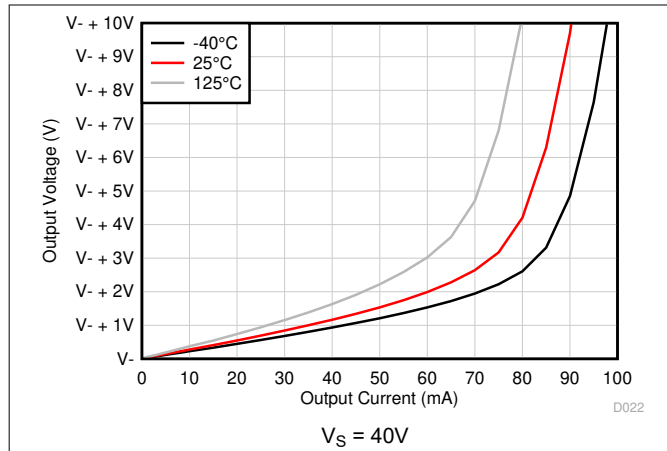

Figure 5-13. Output Voltage Swing vs Output Current (Sinking)

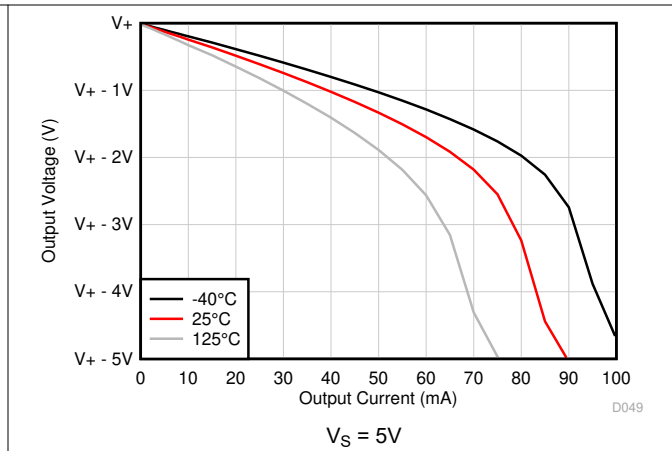

Figure 5-14. Output Voltage Swing vs Output Current (Sourcing)

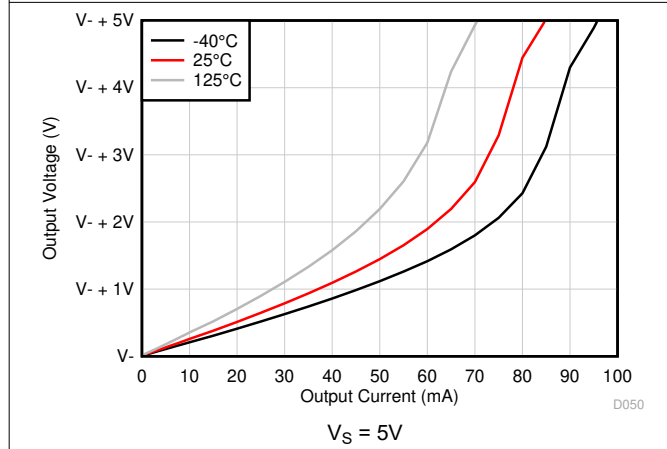

Figure 5-15. Output Voltage Swing vs Output Current (Sinking)

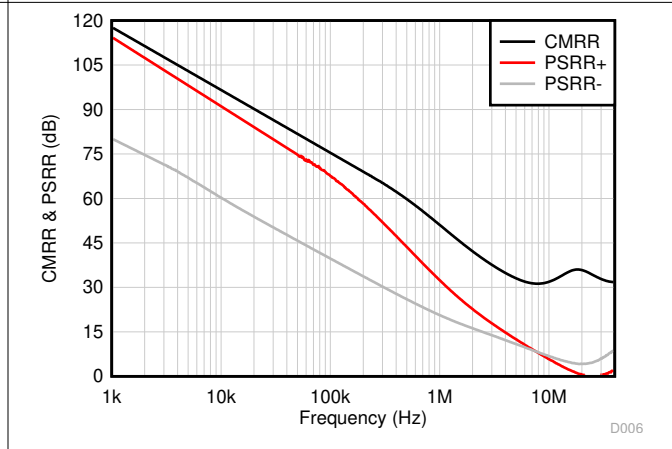

Figure 5-16. CMRR and PSRR vs Frequency

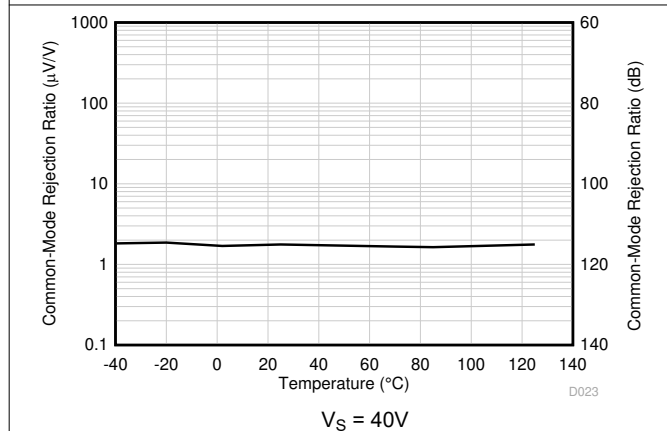

Figure 5-17. CMRR vs Temperature

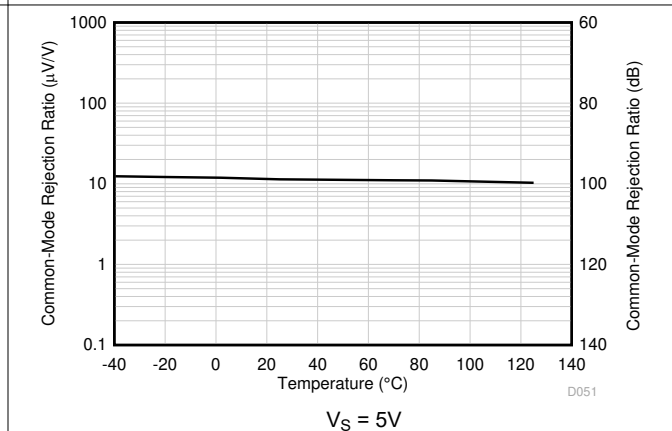
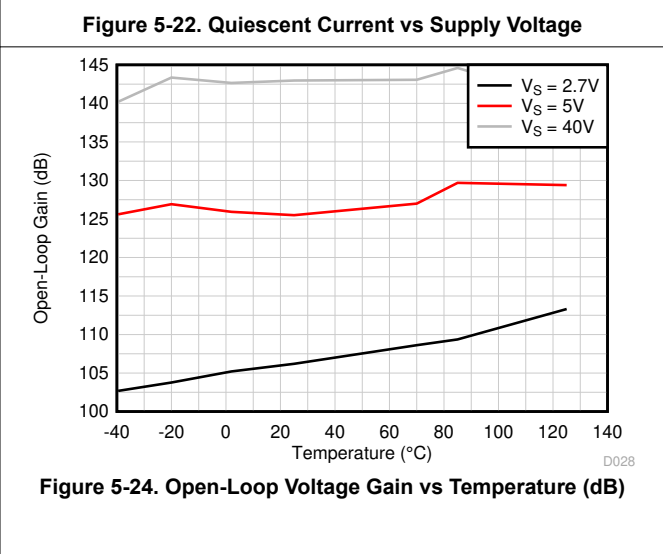
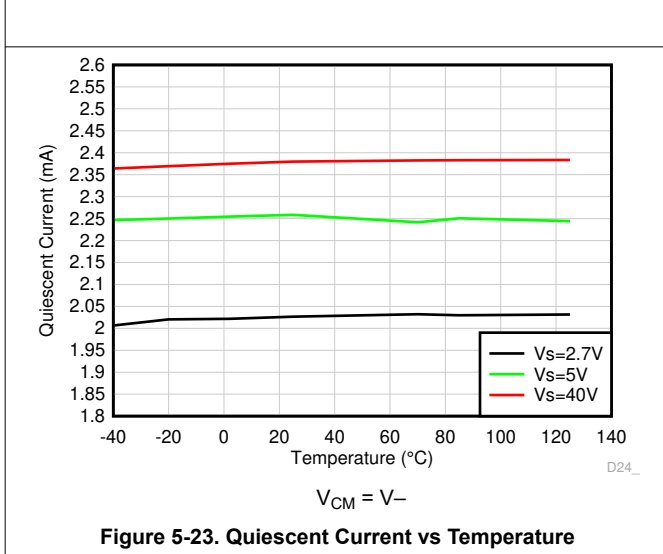
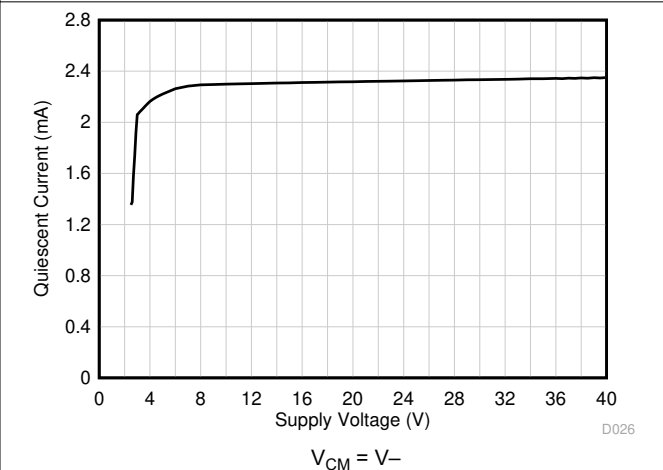
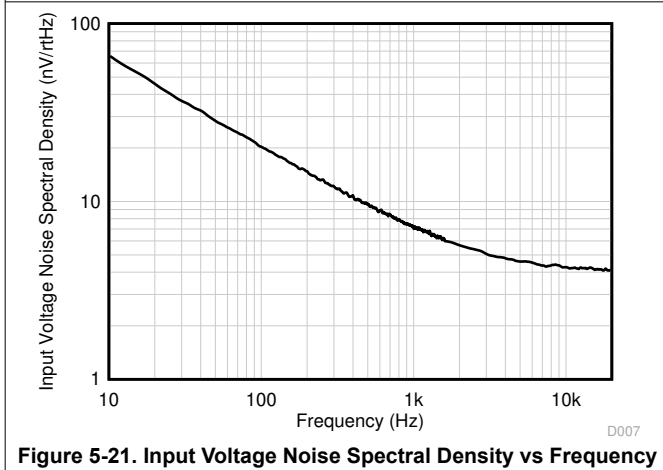
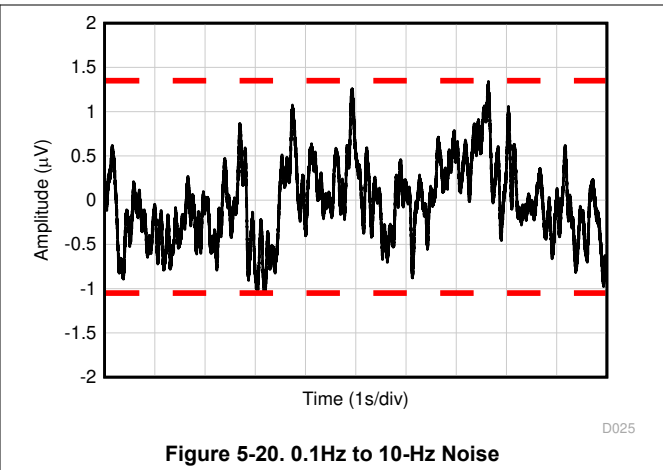
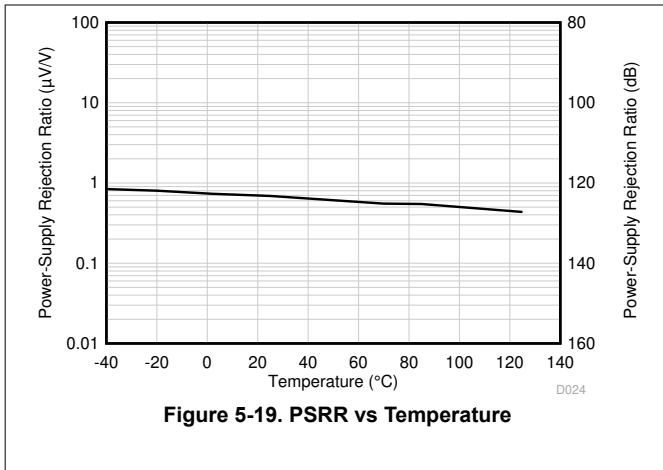

Figure 5-18. CMRR vs Temperature

5.8 Typical Characteristics (continued)

at $T_A = 25^\circ\text{C}$, $V_S = \pm 20\text{V}$, $V_{CM} = V_S / 2$, $R_{LOAD} = 10\text{k}\Omega$ (unless otherwise noted)



5.8 Typical Characteristics (continued)

at $T_A = 25^\circ\text{C}$, $V_S = \pm 20\text{V}$, $V_{CM} = V_S / 2$, $R_{LOAD} = 10\text{k}\Omega$ (unless otherwise noted)

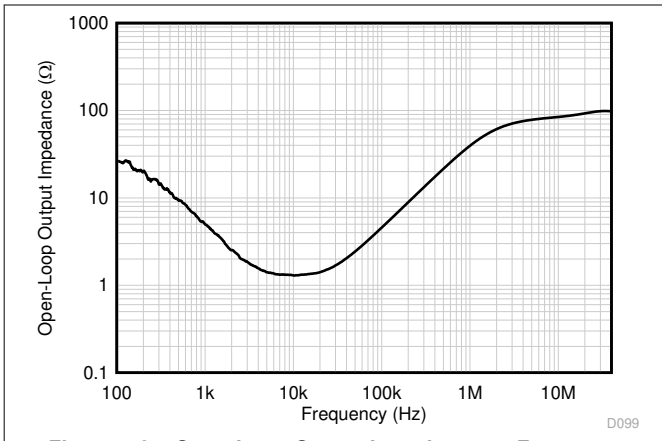

Figure 5-25. Open-Loop Output Impedance vs Frequency

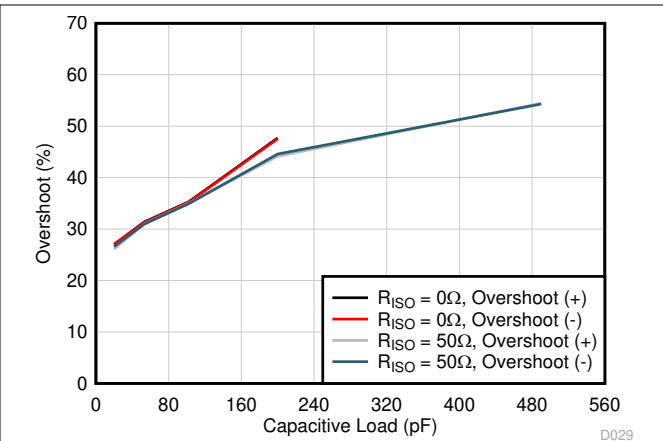

Figure 5-26. Small-Signal Overshoot vs Capacitive Load

20mV_{pp} Output Step, G = -1

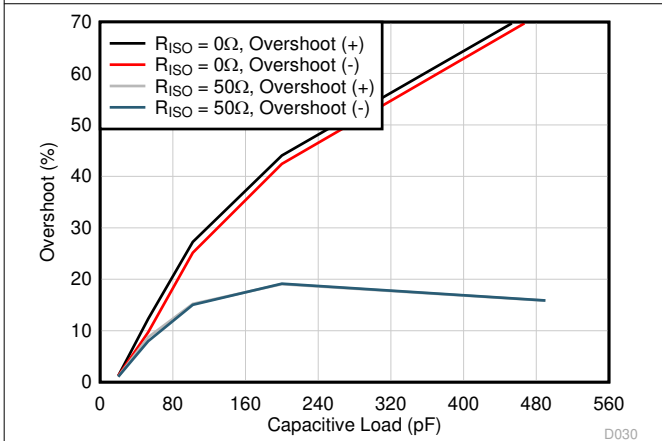

Figure 5-27. Small-Signal Overshoot vs Capacitive Load

20mV_{pp} Output Step, G = +1

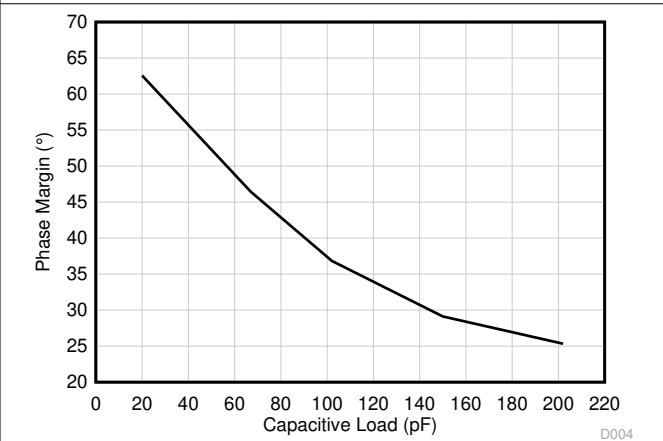

Figure 5-28. Phase Margin vs Capacitive Load

G = +1

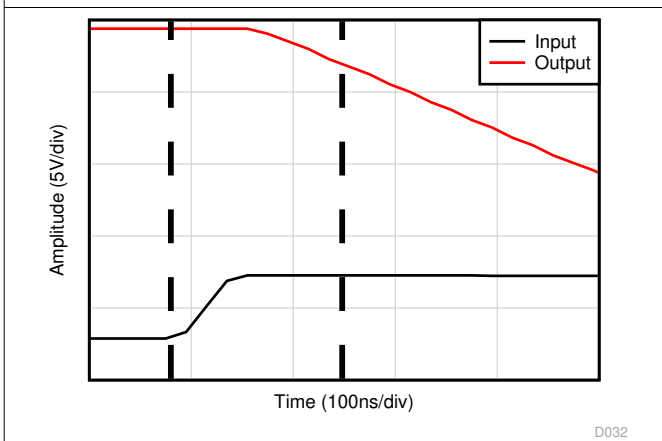

Figure 5-29. Positive Overload Recovery

G = -10

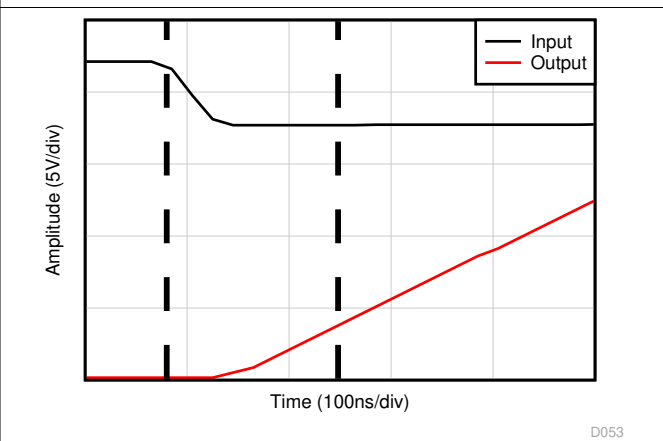
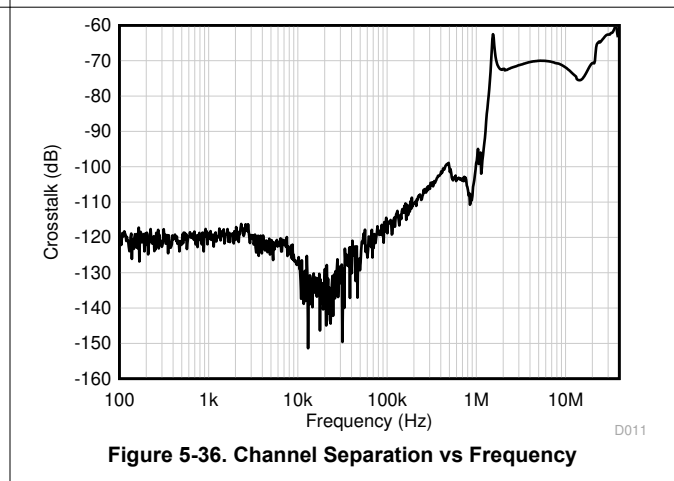
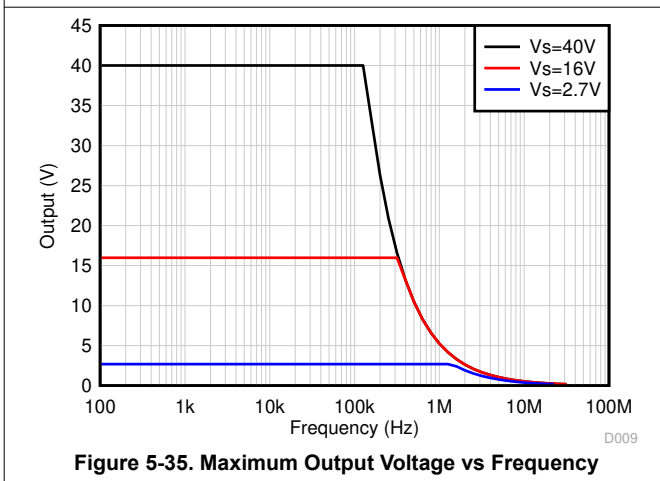
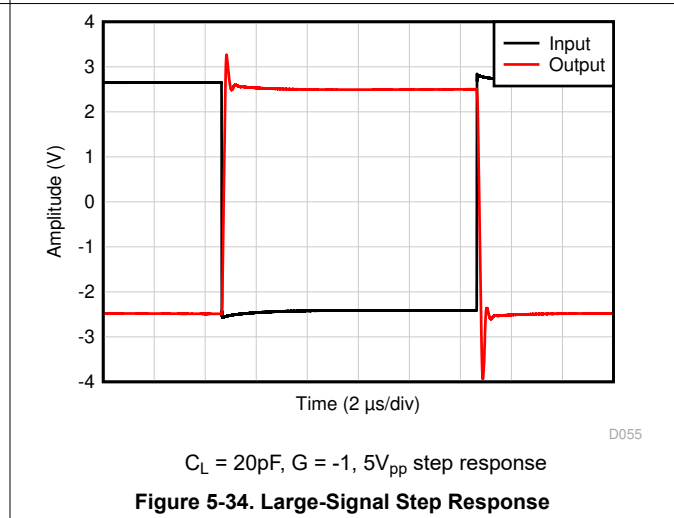
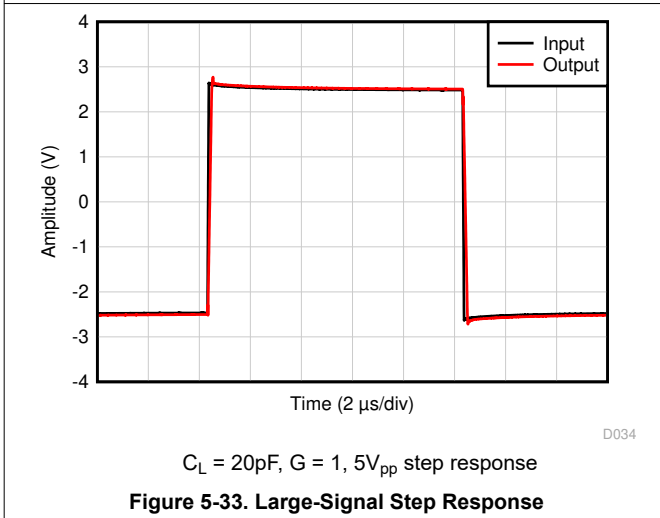
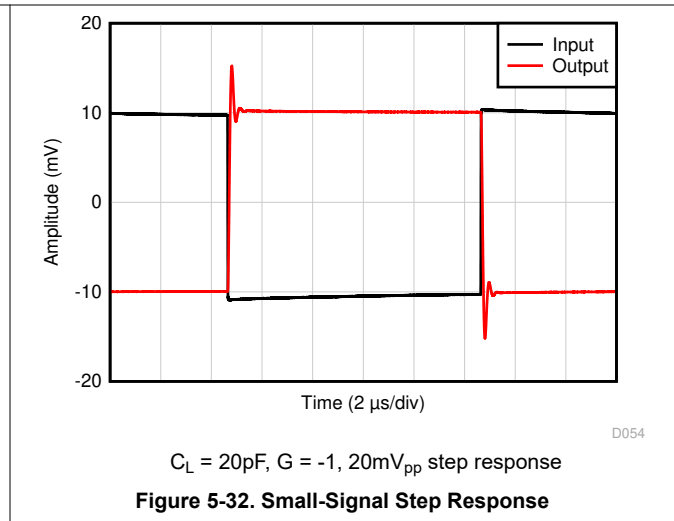
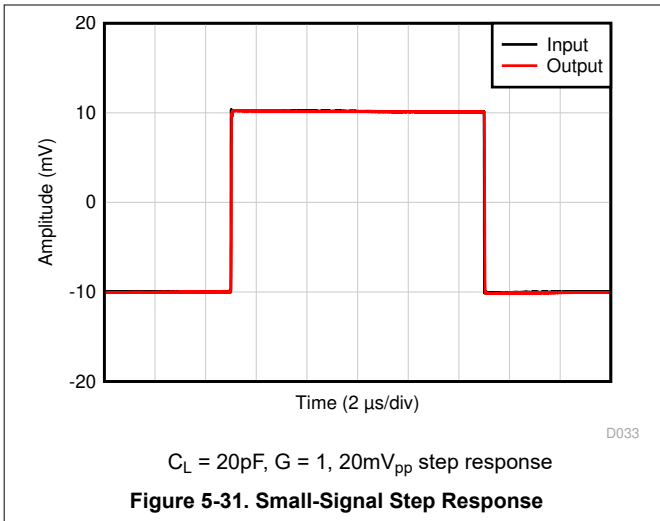

Figure 5-30. Negative Overload Recovery

G = -10

5.8 Typical Characteristics (continued)

at $T_A = 25^\circ\text{C}$, $V_S = \pm 20\text{V}$, $V_{CM} = V_S / 2$, $R_{LOAD} = 10\text{k}\Omega$ (unless otherwise noted)



TLV9361-Q1, TLV9362-Q1, TLV9364-Q1

SBOSAD6B – APRIL 2023 – REVISED AUGUST 2024

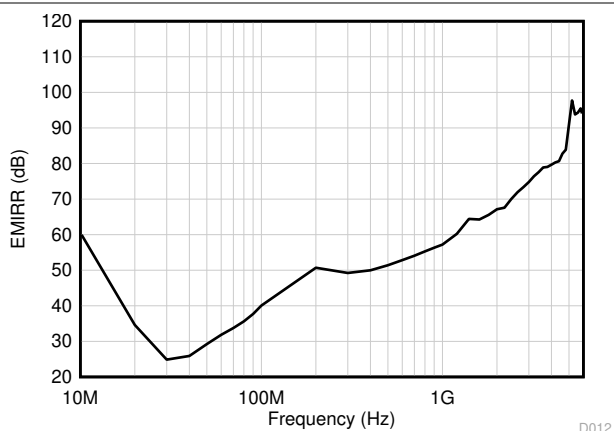
5.8 Typical Characteristics (continued)at $T_A = 25^\circ\text{C}$, $V_S = \pm 20\text{V}$, $V_{CM} = V_S / 2$, $R_{LOAD} = 10\text{k}\Omega$ (unless otherwise noted)**Figure 5-37. EMIRR (Electromagnetic Interference Rejection Ratio) vs Frequency**

6 Detailed Description

6.1 Overview

The TLV936x-Q1 family (TLV9361-Q1, TLV9362-Q1, and TLV9364-Q1) is a family of 40V, cost-optimized operational amplifiers. These devices offer strong general-purpose DC and AC specifications, including rail-to-rail output, low offset ($\pm 400\mu\text{V}$, typical), low offset drift ($\pm 1.25\mu\text{V}/^\circ\text{C}$, typical), and 10.6MHz bandwidth.

Convenient features such as wide differential input-voltage range, high output current ($\pm 60\text{mA}$), and high slew rate ($25\text{V}/\mu\text{s}$) make the TLV936x-Q1 a robust operational amplifier for high-voltage, cost-sensitive applications.

The TLV936x-Q1 family of op amps is available in standard packages and is specified from -40°C to 125°C .

6.2 Functional Block Diagram

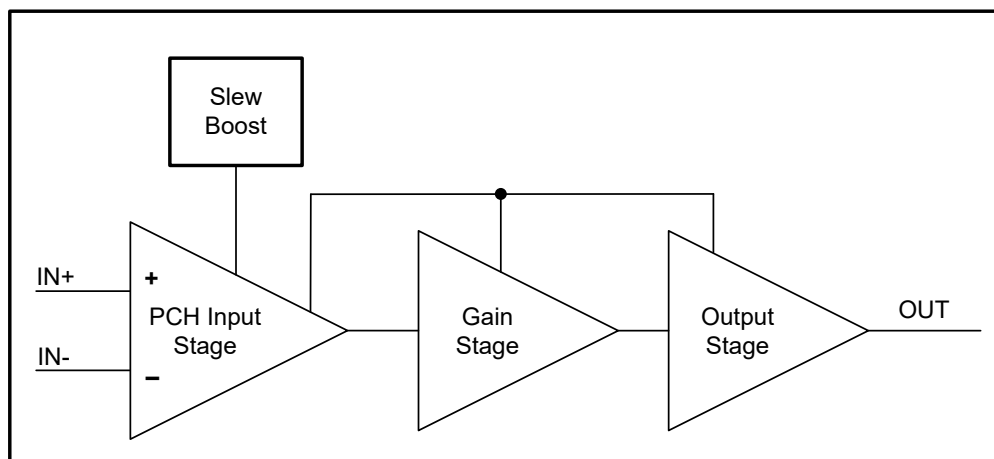

6.3 Feature Description

6.3.1 EMI Rejection

The TLV936x-Q1 uses integrated electromagnetic interference (EMI) filtering to reduce the effects of EMI from sources such as wireless communications and densely-populated boards with a mix of analog signal chain and digital components. EMI immunity can be improved with circuit design techniques; the TLV936x-Q1 benefits from these design improvements. Texas Instruments has developed the ability to accurately measure and quantify the immunity of an operational amplifier over a broad frequency spectrum extending from 10MHz to 6GHz. [Figure 6-1](#) shows the results of this testing on the TLV936x-Q1. [Table 6-1](#) lists the EMIRR IN+ values for the TLV936x-Q1 at particular frequencies commonly encountered in real-world applications. [Table 6-1](#) lists applications that can be centered on or operated near the particular frequency shown. The [EMI Rejection Ratio of Operational Amplifiers](#) application report contains detailed information on the topic of EMIRR performance as relates to op amps and is available for download from www.ti.com.

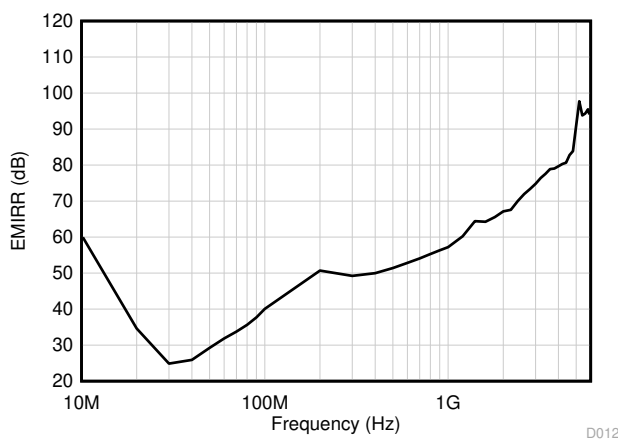

Figure 6-1. EMIRR Testing

Table 6-1. TLV936x-Q1 EMIRR IN+ for Frequencies of Interest

FREQUENCY	APPLICATION OR ALLOCATION	EMIRR IN+
400MHz	Mobile radio, mobile satellite, space operation, weather, radar, ultra-high frequency (UHF) applications	50.0dB
900MHz	Global system for mobile communications (GSM) applications, radio communication, navigation, GPS (to 1.6GHz), GSM, aeronautical mobile, UHF applications	56.3dB
1.8GHz	GSM applications, mobile personal communications, broadband, satellite, L-band (1GHz to 2GHz)	65.6dB
2.4GHz	802.11b, 802.11g, 802.11n, Bluetooth®, mobile personal communications, industrial, scientific and medical (ISM) radio band, amateur radio and satellite, S-band (2GHz to 4GHz)	70.0dB
3.6GHz	Radiolocation, aero communication and navigation, satellite, mobile, S-band	78.9dB
5GHz	802.11a, 802.11n, aero communication and navigation, mobile communication, space and satellite operation, C-band (4GHz to 8GHz)	91.0dB

6.3.2 Thermal Protection

The internal power dissipation of any amplifier causes the internal (junction) temperature to rise. This phenomenon is called *self heating*. The absolute maximum junction temperature of the TLV936x-Q1 is 150°C. Exceeding this temperature causes damage to the device. The TLV936x-Q1 has a thermal protection feature that reduces damage from self heating. The protection works by monitoring the temperature of the device and turning off the op amp output drive for temperatures above 170°C. [Figure 6-2](#) shows an application example for the TLV9362-Q1 that has significant self heating because of the power dissipation (0.954W). In this example, both channels have a quiescent power dissipation while one of the channels has a significant load. Thermal calculations indicate that for an ambient temperature of 55°C, the device junction temperature reaches 180°C. The actual device, however, turns off the output drive to recover towards a safe junction temperature. [Figure 6-2](#)

shows how the circuit behaves during thermal protection. During normal operation, the device acts as a buffer so the output is 3V.

When self heating causes the device junction temperature to increase above the internal limit, the thermal protection forces the output to a high-impedance state and the output is pulled to ground through resistor R_L . If the condition that caused excessive power dissipation is not removed, the amplifier oscillates between a shutdown and enabled state until the output fault is corrected. Please note that thermal performance can vary greatly depending on the package selected and the PCB layout design. This example uses the thermal performance of the SOIC (8) package.

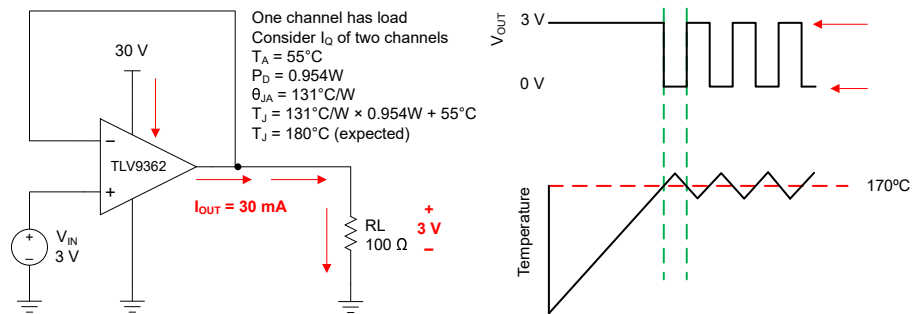

Figure 6-2. Thermal Protection

6.3.3 Capacitive Load and Stability

The TLV936x-Q1 features an output stage capable of driving moderate capacitive loads, and by leveraging an isolation resistor, the device can easily be configured to driver large capacitive loads. Increasing the gain enhances the ability of the amplifier to drive greater capacitive loads; see [Figure 6-3](#) and [Figure 6-4](#). The particular op amp circuit configuration, layout, gain, and output loading are some of the factors to consider when establishing whether an amplifier is stable in operation.

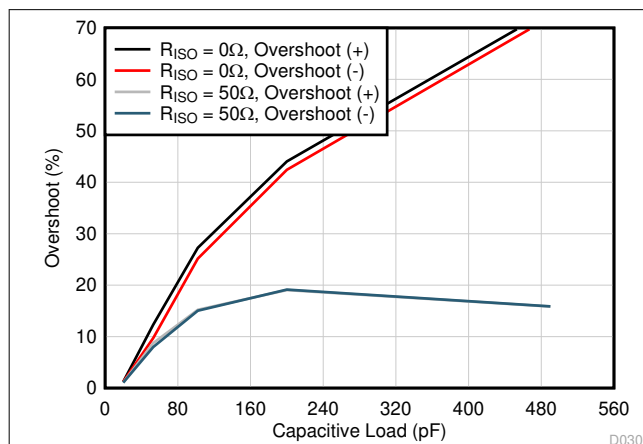

Figure 6-3. Small-Signal Overshoot vs Capacitive Load (20mV_{pp} Output Step, G = +1)

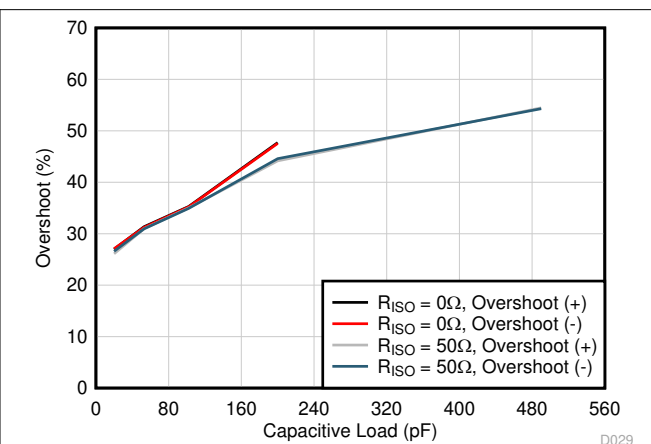

Figure 6-4. Small-Signal Overshoot vs Capacitive Load (20mV_{pp} Output Step, G = -1)

For additional drive capability in unity-gain configurations, improve capacitive load drive by inserting a small resistor, R_{ISO} , in series with the output, as shown in [Figure 6-5](#). This resistor significantly reduces ringing and maintains DC performance for purely capacitive loads. However, if a resistive load is in parallel with the capacitive load, then a voltage divider is created, thus introducing a gain error at the output and slightly reducing the output swing. The error introduced is proportional to the ratio R_{ISO} / R_L , and is generally negligible at low output levels. A high capacitive load drive makes the TLV936x-Q1 an excellent choice for applications such as reference buffers, MOSFET gate drives, and cable-shield drives. The circuit shown in [Figure 6-5](#) uses an

TLV9361-Q1, TLV9362-Q1, TLV9364-Q1

SBOSAD6B – APRIL 2023 – REVISED AUGUST 2024

isolation resistor, R_{ISO} , to stabilize the output of an op amp. R_{ISO} modifies the open-loop gain of the system for increased phase margin.

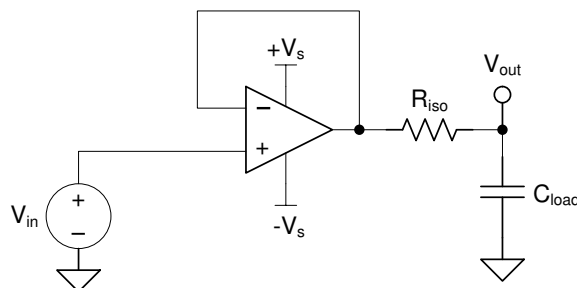

Figure 6-5. Extending Capacitive Load Drive With the TLV9361-Q1

6.3.4 Electrical Overstress

Designers often ask questions about the capability of an operational amplifier to withstand electrical overstress (EOS). These questions tend to focus on the device inputs, but can involve the supply voltage pins or even the output pin. Each of these different pin functions have electrical stress limits determined by the voltage breakdown characteristics of the particular semiconductor fabrication process and specific circuits connected to the pin. Additionally, internal electrostatic discharge (ESD) protection is built into these circuits to protect them from accidental ESD events both before and during product assembly.

Having a good understanding of this basic ESD circuitry and relevance to an electrical overstress event is helpful. Figure 6-6 shows an illustration of the ESD circuits contained in the TLV936x-Q1 (indicated by the dashed line area). The ESD protection circuitry involves several current-steering diodes connected from the input and output pins and routed back to the internal power-supply lines, where the diodes meet at an absorption device or the power-supply ESD cell, internal to the operational amplifier. This protection circuitry is intended to remain inactive during normal circuit operation.

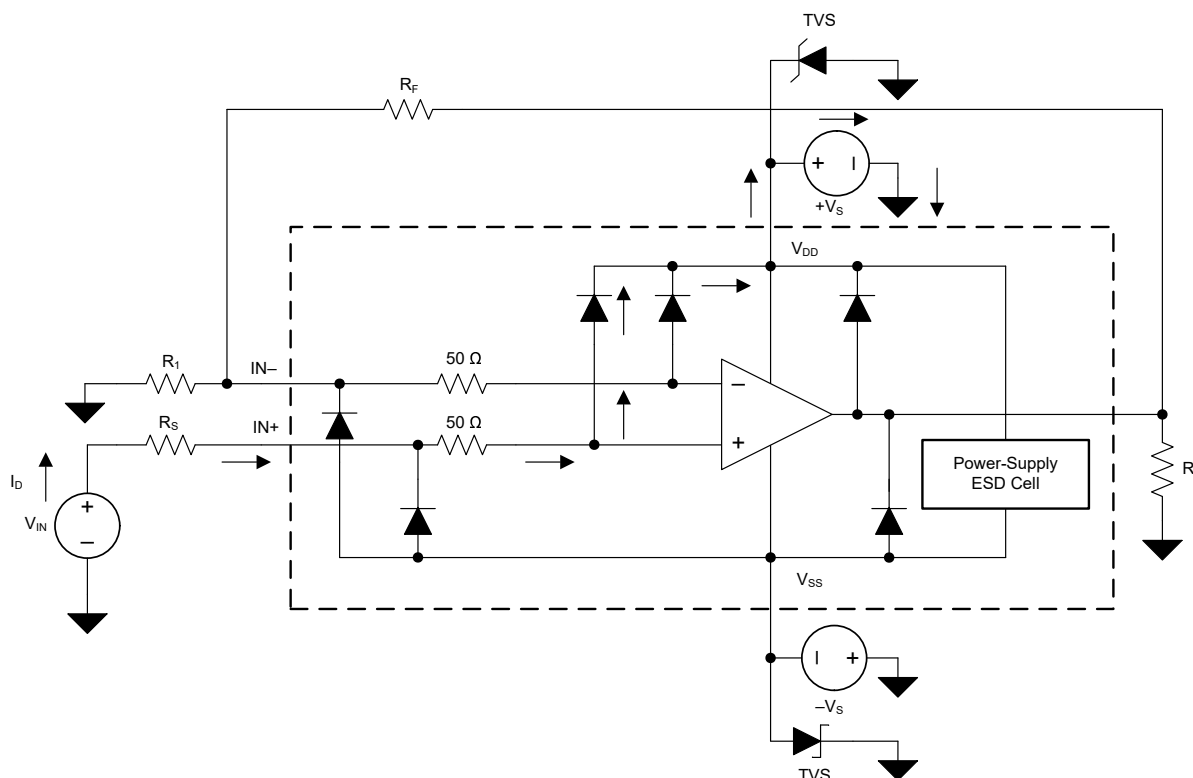

Figure 6-6. Equivalent Internal ESD Circuitry Relative to a Typical Circuit Application

An ESD event is very short in duration and very high voltage (for example; 1kV, 100ns), whereas an EOS event is long duration and lower voltage (for example; 50V, 100ms). The ESD diodes are designed for out-of-circuit ESD protection (that is; during assembly, test, and storage of the device before being soldered to the PCB). During an ESD event, the ESD signal is passed through the ESD steering diodes to an absorption circuit (labeled ESD power-supply circuit). The ESD absorption circuit clamps the supplies to a safe level.

Although this behavior is necessary for out-of-circuit protection, excessive current and damage is caused if activated in-circuit. A transient voltage suppressors (TVS) can be used to prevent against damage caused by turning on the ESD absorption circuit during an in-circuit ESD event. Using the appropriate current limiting resistors and TVS diodes allows for the use of device ESD diodes to protect against EOS events.

6.3.5 Overload Recovery

Overload recovery is defined as the time required for the op amp output to recover from a saturated state to a linear state. The output devices of the op amp enter a saturation region when the output voltage exceeds the rated operating voltage, either due to the high input voltage or the high gain. After the device enters the saturation region, the charge carriers in the output devices require time to return back to the linear state. After the charge carriers return back to the linear state, the device begins to slew at the specified slew rate. Thus, the propagation delay in case of an overload condition is the sum of the overload recovery time and the slew time. The overload recovery time for the TLV936x-Q1 is approximately 170ns.

6.3.6 Typical Specifications and Distributions

Designers often have questions about a typical specification of an amplifier to design a more robust circuit. Due to natural variation in process technology and manufacturing procedures, every specification of an amplifier exhibits some amount of deviation from the ideal value, like the input offset voltage of an amplifier. These deviations often follow *Gaussian (bell curve)*, or *normal* distributions, and circuit designers leverage this information to guard band systems, even when there are no minimum or maximum specifications in the [Electrical Characteristics](#) table.

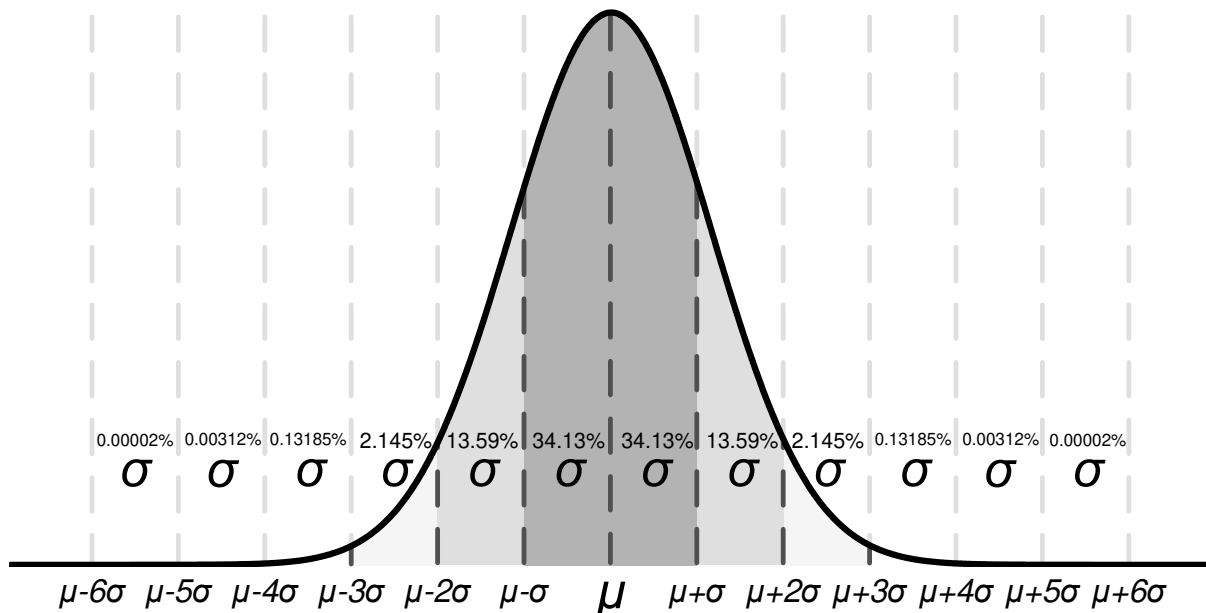

Figure 6-7. Ideal Gaussian Distribution

Figure 6-7 shows an example distribution, where μ , or *mu*, is the mean of the distribution, and σ , or *sigma*, is the standard deviation of a system. For a specification that exhibits this kind of distribution, approximately two-thirds (68.26%) of all units can be expected to have a value within one standard deviation, or one sigma, of the mean (from $\mu - \sigma$ to $\mu + \sigma$).

Depending on the specification, values listed in the *typical* column of the [Electrical Characteristics](#) table are represented in different ways. As a general rule, if a specification naturally has a nonzero mean (for example, like gain bandwidth), then the typical value is equal to the mean (μ). However, if a specification naturally has a mean near zero (like input offset voltage), then the typical value is equal to the mean plus one standard deviation ($\mu + \sigma$) to most accurately represent the typical value.

Use this chart to calculate approximate probability of a specification in a unit; for example, for TLV936x-Q1, the typical input voltage offset is $400\mu\text{V}$, so 68.2% of all TLV936x-Q1 devices are expected to have an offset from $-400\mu\text{V}$ to $400\mu\text{V}$. At 4σ ($\pm 1600\mu\text{V}$), 99.9937% of the distribution has an offset voltage less than $\pm 1600\mu\text{V}$, which means 0.0063% of the population is outside of these limits, which corresponds to about 1 in 15,873 units.

Specifications with a value in the minimum or maximum column are specified by TI, and units outside these limits are removed from production material. For example, the TLV936x-Q1 family has a maximum offset voltage of 1.7mV at 125°C, and even though this corresponds to about 4.25σ (≈ 2 in 100,000 units), which is unlikely, TI verifies that any unit with larger offset than 1.7mV is removed from production material.

For specifications with no value in the minimum or maximum column, consider selecting a sigma value of sufficient guardband for your application, and design worst-case conditions using this value. For example, the 6σ value corresponds to about 1 in 500 million units, which is an extremely unlikely chance, and can be an option as a wide guardband to design a system around. In this case, the TLV936x-Q1 family does not have a maximum or minimum for offset voltage drift, but based on the typical value of $1.25\mu\text{V}/^\circ\text{C}$ in the [Electrical Characteristics](#) table, the 6σ value is calculated for offset voltage drift is about $7.5\mu\text{V}/^\circ\text{C}$. When designing for worst-case system conditions, use this value to estimate the worst possible offset across temperature without having an actual minimum or maximum value.

However, process variation and adjustments over time can shift typical means and standard deviations, and unless there is a value in the minimum or maximum specification column, TI cannot verify the performance of a device. This information must be used only to estimate the performance of a device.

6.4 Device Functional Modes

The TLV936x-Q1 has a single functional mode and is operational when the power-supply voltage is greater than 4.5V ($\pm 2.25\text{V}$). The maximum power supply voltage for the TLV936x-Q1 is 40V ($\pm 20\text{V}$).

7 Application and Implementation

Note

Information in the following applications sections is not part of the TI component specification, and TI does not warrant its accuracy or completeness. TI's customers are responsible for determining suitability of components for their purposes, as well as validating and testing their design implementation to confirm system functionality.

7.1 Application Information

The TLV936x-Q1 family offers excellent DC precision and DC performance. These devices operate up to 40V supply rails and offer true rail-to-rail output, low offset voltage and offset voltage drift, as well as 10.6MHz bandwidth and high output drive. These features make the TLV936x-Q1 a robust, high-performance operational amplifier for high-voltage cost-sensitive applications.

7.2 Typical Applications

7.2.1 Low-Side Current Measurement

Figure 7-1 shows the TLV936x-Q1 configured in a low-side current sensing application. For a full analysis of the circuit shown in Figure 7-1 including theory, calculations, simulations, and measured data, see TI Precision Design TIPD129, [0A to 1A Single-Supply Low-Side Current-Sensing Solution](#).

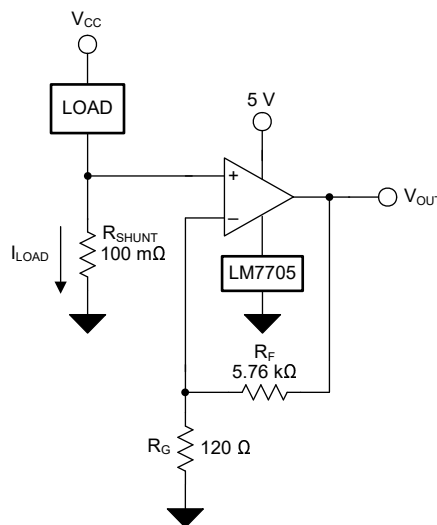

Figure 7-1. TLV936x-Q1 in a Low-Side, Current-Sensing Application

7.2.2 Design Requirements

The design requirements for this design are:

- Load current: 0A to 1A
- Max output voltage: 4.9V
- Maximum shunt voltage: 100mV

7.2.3 Detailed Design Procedure

The transfer function of the circuit in Figure 7-1 is given in Equation 1:

$$V_{OUT} = I_{LOAD} \times R_{SHUNT} \times \text{Gain} \quad (1)$$

TLV9361-Q1, TLV9362-Q1, TLV9364-Q1

SBOSAD6B – APRIL 2023 – REVISED AUGUST 2024

The load current (I_{LOAD}) produces a voltage drop across the shunt resistor (R_{SHUNT}). The load current is set from 0A to 1A. To keep the shunt voltage below 100mV at maximum load current, the largest shunt resistor is defined using Equation 2:

$$R_{SHUNT} = \frac{V_{SHUNT_MAX}}{I_{LOAD_MAX}} = \frac{100\text{ mV}}{1\text{ A}} = 100\text{ m}\Omega \quad (2)$$

Using Equation 2, R_{SHUNT} is calculated to be 100m Ω . The voltage drop produced by I_{LOAD} and R_{SHUNT} is amplified by the TLV936x-Q1 to produce an output voltage of 0V to 4.9V. The gain needed by the TLV936x-Q1 to produce the necessary output voltage is calculated using Equation 3:

$$\text{Gain} = \frac{(V_{OUT_MAX} - V_{OUT_MIN})}{(V_{IN_MAX} - V_{IN_MIN})} \quad (3)$$

Using Equation 3, the required gain is calculated to be 49V/V, which is set with resistors R_F and R_G . Equation 4 is used to size the resistors, R_F and R_G , to set the gain of the TLV936x-Q1 to 49V/V.

$$\text{Gain} = 1 + \frac{(R_F)}{(R_G)} \quad (4)$$

Choosing R_F as 5.76k Ω , R_G is calculated to be 120 Ω . R_F and R_G were chosen as 5.76k Ω and 120 Ω because the values are standard value resistors that create a 49:1 ratio. Other resistors that create a 49:1 ratio can also be used. However, excessively large resistors generate thermal noise that exceeds the intrinsic noise of the op amp. Figure 7-2 shows the measured transfer function of the circuit shown in Figure 7-1.

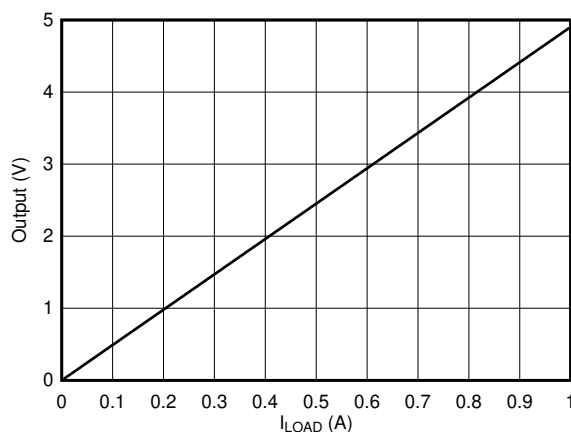
7.2.4 Application Curves**Figure 7-2. Low-Side, Current-Sense, Transfer Function****7.3 Power Supply Recommendations**

The TLV936x-Q1 is specified for operation from 4.5V to 40V ($\pm 2.25\text{V}$ to $\pm 20\text{V}$); many specifications apply from -40°C to 125°C .

CAUTION

Supply voltages larger than 40V can permanently damage the device; see the [Absolute Maximum Ratings](#) table.

Place 0.1 μF bypass capacitors close to the power-supply pins to reduce errors coupling in from noisy or high-impedance power supplies. For more detailed information on bypass capacitor placement, refer to the [Layout](#) section.

7.4 Layout

7.4.1 Layout Guidelines

For best operational performance of the device, use good PCB layout practices, including:

- Noise can propagate into analog circuitry through the power pins of the circuit as a whole and op amp itself. Bypass capacitors are used to reduce the coupled noise by providing low-impedance power sources local to the analog circuitry.
 - Connect low-ESR, 0.1- μ F ceramic bypass capacitors between each supply pin and ground, placed as close to the device as possible. A single bypass capacitor from V+ to ground is applicable for single-supply applications.
- Separate grounding for analog and digital portions of circuitry is one of the simplest and most-effective methods of noise suppression. One or more layers on multilayer PCBs are usually devoted to ground planes. A ground plane helps distribute heat and reduces EMI noise pickup. Make sure to physically separate digital and analog grounds paying attention to the flow of the ground current.
- To reduce parasitic coupling, run the input traces as far away from the supply or output traces as possible. If these traces cannot be kept separate, crossing the sensitive trace perpendicular is much better as opposed to in parallel with the noisy trace.
- Place the external components as close to the device as possible. As shown in [Figure 7-4](#), keeping RF and RG close to the inverting input minimizes parasitic capacitance.
- Keep the length of input traces as short as possible. Always remember that the input traces are the most sensitive part of the circuit.
- Consider a driven, low-impedance guard ring around the critical traces. A guard ring can significantly reduce leakage currents from nearby traces that are at different potentials.
- Cleaning the PCB following board assembly is recommended for best performance.
- Any precision integrated circuit can experience performance shifts due to moisture ingress into the plastic package. Following any aqueous PCB cleaning process, baking the PCB assembly is recommended to remove moisture introduced into the device packaging during the cleaning process. A low temperature, post cleaning bake at 85°C for 30 minutes is sufficient for most circumstances.

TLV9361-Q1, TLV9362-Q1, TLV9364-Q1
 SBOSAD6B – APRIL 2023 – REVISED AUGUST 2024

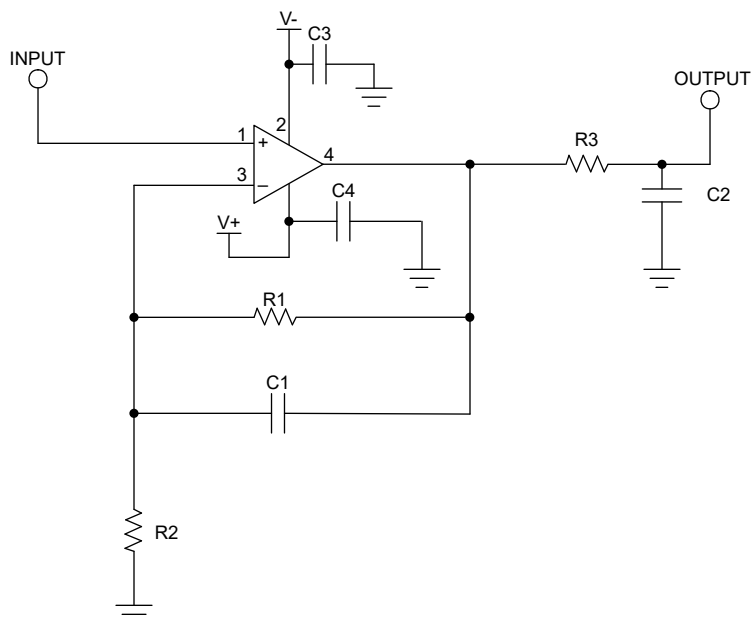
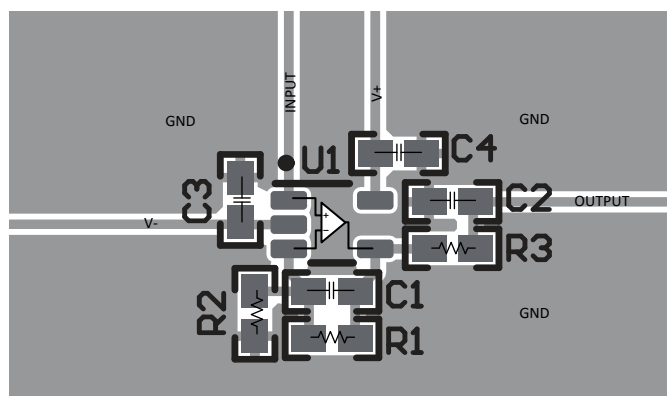
7.4.2 Layout Example

Figure 7-3. Schematic for Non-inverting Configuration Layout Example

Figure 7-4. Operational Amplifier Board Layout for Non-inverting Configuration - SC70 (DCK) Package

8 Device and Documentation Support

8.1 Device Support

8.1.1 Development Support

8.1.1.1 TINA-TI™ (Free Software Download)

TINA™ is a simple, powerful, and easy-to-use circuit simulation program based on a SPICE engine. TINA-TI is a free, fully-functional version of the TINA software, preloaded with a library of macro models in addition to a range of both passive and active models. TINA-TI provides all the conventional dc, transient, and frequency domain analysis of SPICE, as well as additional design capabilities.

Available as a [free download](#) from the Analog eLab Design Center, TINA-TI offers extensive post-processing capability that allows users to format results in a variety of ways. Virtual instruments offer the ability to select input waveforms and probe circuit nodes, voltages, and waveforms, creating a dynamic quick-start tool.

Note

These files require that either the TINA software (from DesignSoft™) or TINA-TI software be installed. Download the free TINA-TI software from the [TINA-TI folder](#).

8.1.1.2 TI Precision Designs

The TLV936x-Q1 is featured in several TI Precision Designs, available online at <http://www.ti.com/ww/en/analog/precision-designs/>. TI Precision Designs are analog solutions created by TI's precision analog applications experts and offer the theory of operation, component selection, simulation, complete PCB schematic and layout, bill of materials, and measured performance of many useful circuits.

8.2 Documentation Support

8.2.1 Related Documentation

For related documentation, see the following:

- Texas Instruments, [Analog Engineer's Circuit Cookbook: Amplifiers](#)
- Texas Instruments, [AN31 amplifier circuit collection](#) application report
- Texas Instruments, [EMI Rejection Ratio of Operational Amplifiers](#) application report
- Texas Instruments, [Capacitive Load Drive Solution using an Isolation Resistor](#) reference design

8.3 Receiving Notification of Documentation Updates

To receive notification of documentation updates, navigate to the device product folder on ti.com. Click on *Notifications* to register and receive a weekly digest of any product information that has changed. For change details, review the revision history included in any revised document.

8.4 Support Resources

[TI E2E™ support forums](#) are an engineer's go-to source for fast, verified answers and design help — straight from the experts. Search existing answers or ask your own question to get the quick design help you need.

Linked content is provided "AS IS" by the respective contributors. They do not constitute TI specifications and do not necessarily reflect TI's views; see TI's [Terms of Use](#).

8.5 Trademarks

TINA-TI™ is a trademark of Texas Instruments, Inc and DesignSoft, Inc.

TINA™ and DesignSoft™ are trademarks of DesignSoft, Inc.

TI E2E™ is a trademark of Texas Instruments.

Bluetooth® is a registered trademark of Bluetooth SIG, Inc.

All trademarks are the property of their respective owners.

8.6 Electrostatic Discharge Caution



This integrated circuit can be damaged by ESD. Texas Instruments recommends that all integrated circuits be handled with appropriate precautions. Failure to observe proper handling and installation procedures can cause damage.

ESD damage can range from subtle performance degradation to complete device failure. Precision integrated circuits may be more susceptible to damage because very small parametric changes could cause the device not to meet its published specifications.

8.7 Glossary

[TI Glossary](#) This glossary lists and explains terms, acronyms, and definitions.

9 Revision History

NOTE: Page numbers for previous revisions may differ from page numbers in the current version.

Changes from Revision A (May 2023) to Revision B (August 2024)	Page
• Added the TLV9362-Q1 PW package to the <i>Package Information</i> table.....	1
• Changed the <i>Package Information</i> measurements from: <i>Body Size (Nom)</i> to: <i>Package Size</i>	1
• Added the TLV9362-Q1 PW package to <i>Pin Configuration and Functions</i>	3
• Added 8-pin TSSOP (PW) package to <i>Thermal Information for Dual Channel table</i>	7

Changes from Revision * (April 2023) to Revision A (May 2023)	Page
• Changed the status of the D and DGK packages from: <i>preview</i> to: <i>active</i>	1

10 Mechanical, Packaging, and Orderable Information

The following pages include mechanical, packaging, and orderable information. This information is the most current data available for the designated devices. This data is subject to change without notice and revision of this document. For browser-based versions of this data sheet, refer to the left-hand navigation.

PACKAGING INFORMATION

Orderable Device	Status (1)	Package Type	Package Drawing	Pins	Package Qty	Eco Plan (2)	Lead finish/ Ball material (6)	MSL Peak Temp (3)	Op Temp (°C)	Device Marking (4/5)	Samples
TLV9361QDBVRQ1	ACTIVE	SOT-23	DBV	5	3000	RoHS & Green	SN	Level-1-260C-UNLIM	-40 to 125	2W1H	Samples
TLV9361QDCKRQ1	ACTIVE	SC70	DCK	5	3000	RoHS & Green	NIPDAU	Level-1-260C-UNLIM	-40 to 125	1NL	Samples
TLV9362QDGKRQ1	ACTIVE	VSSOP	DGK	8	2500	RoHS & Green	NIPDAU	Level-1-260C-UNLIM	-40 to 125	2S6T	Samples
TLV9362QDRQ1	ACTIVE	SOIC	D	8	3000	RoHS & Green	NIPDAU	Level-1-260C-UNLIM	-40 to 125	T9362D	Samples
TLV9362QPWRQ1	ACTIVE	TSSOP	PW	8	3000	RoHS & Green	NIPDAU	Level-1-260C-UNLIM	-40 to 125	9362PW	Samples
TLV9364QDRQ1	ACTIVE	SOIC	D	14	3000	RoHS & Green	NIPDAU	Level-1-260C-UNLIM	-40 to 125	TLV9364QD	Samples
TLV9364QPWRQ1	ACTIVE	TSSOP	PW	14	3000	RoHS & Green	NIPDAU	Level-1-260C-UNLIM	-40 to 125	T9364PW	Samples

(1) The marketing status values are defined as follows:

ACTIVE: Product device recommended for new designs.

LIFEBUY: TI has announced that the device will be discontinued, and a lifetime-buy period is in effect.

NRND: Not recommended for new designs. Device is in production to support existing customers, but TI does not recommend using this part in a new design.

PREVIEW: Device has been announced but is not in production. Samples may or may not be available.

OBSOLETE: TI has discontinued the production of the device.

(2) **RoHS:** TI defines "RoHS" to mean semiconductor products that are compliant with the current EU RoHS requirements for all 10 RoHS substances, including the requirement that RoHS substance do not exceed 0.1% by weight in homogeneous materials. Where designed to be soldered at high temperatures, "RoHS" products are suitable for use in specified lead-free processes. TI may reference these types of products as "Pb-Free".

RoHS Exempt: TI defines "RoHS Exempt" to mean products that contain lead but are compliant with EU RoHS pursuant to a specific EU RoHS exemption.

Green: TI defines "Green" to mean the content of Chlorine (Cl) and Bromine (Br) based flame retardants meet JS709B low halogen requirements of <=1000ppm threshold. Antimony trioxide based flame retardants must also meet the <=1000ppm threshold requirement.

(3) MSL, Peak Temp. - The Moisture Sensitivity Level rating according to the JEDEC industry standard classifications, and peak solder temperature.

(4) There may be additional marking, which relates to the logo, the lot trace code information, or the environmental category on the device.

(5) Multiple Device Markings will be inside parentheses. Only one Device Marking contained in parentheses and separated by a "~" will appear on a device. If a line is indented then it is a continuation of the previous line and the two combined represent the entire Device Marking for that device.

⁽⁶⁾ Lead finish/Ball material - Orderable Devices may have multiple material finish options. Finish options are separated by a vertical ruled line. Lead finish/Ball material values may wrap to two lines if the finish value exceeds the maximum column width.

Important Information and Disclaimer:The information provided on this page represents TI's knowledge and belief as of the date that it is provided. TI bases its knowledge and belief on information provided by third parties, and makes no representation or warranty as to the accuracy of such information. Efforts are underway to better integrate information from third parties. TI has taken and continues to take reasonable steps to provide representative and accurate information but may not have conducted destructive testing or chemical analysis on incoming materials and chemicals. TI and TI suppliers consider certain information to be proprietary, and thus CAS numbers and other limited information may not be available for release.

In no event shall TI's liability arising out of such information exceed the total purchase price of the TI part(s) at issue in this document sold by TI to Customer on an annual basis.

OTHER QUALIFIED VERSIONS OF TLV9361-Q1, TLV9362-Q1, TLV9364-Q1 :

- Catalog : [TLV9361](#), [TLV9362](#), [TLV9364](#)

NOTE: Qualified Version Definitions:

- Catalog - TI's standard catalog product

TAPE AND REEL INFORMATION

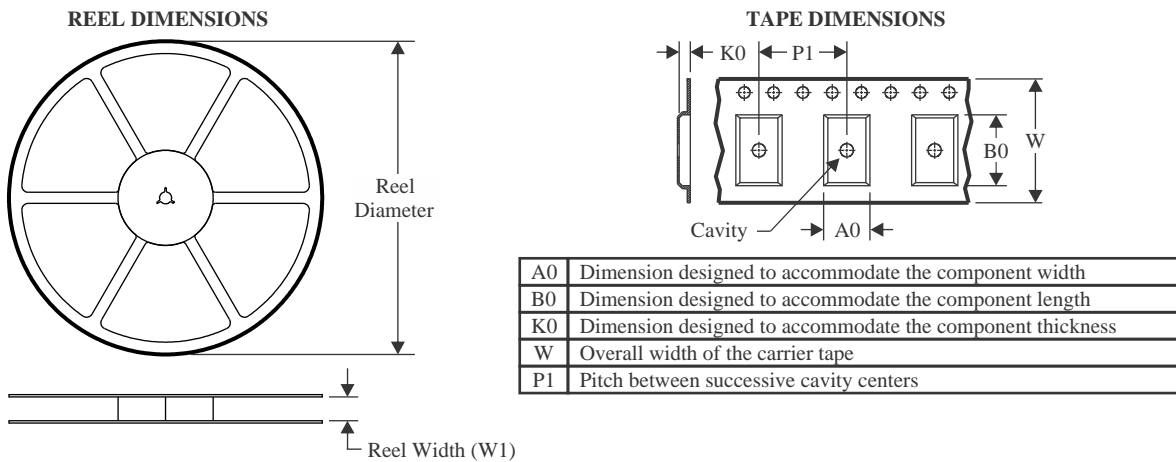

QUADRANT ASSIGNMENTS FOR PIN 1 ORIENTATION IN TAPE

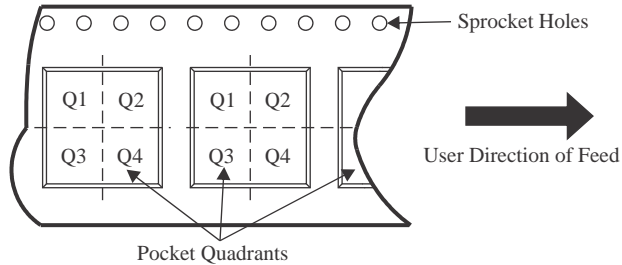

*All dimensions are nominal

Device	Package Type	Package Drawing	Pins	SPQ	Reel Diameter (mm)	Reel Width W1 (mm)	A0 (mm)	B0 (mm)	K0 (mm)	P1 (mm)	W (mm)	Pin1 Quadrant
TLV9361QDBVRQ1	SOT-23	DBV	5	3000	180.0	8.4	3.2	3.2	1.4	4.0	8.0	Q3
TLV9361QDCKRQ1	SC70	DCK	5	3000	178.0	9.0	2.4	2.5	1.2	4.0	8.0	Q3
TLV9362QDGKRQ1	VSSOP	DGK	8	2500	330.0	12.4	5.25	3.35	1.25	8.0	12.0	Q1
TLV9362QDRQ1	SOIC	D	8	3000	330.0	12.4	6.4	5.2	2.1	8.0	12.0	Q1
TLV9362QPWRQ1	TSSOP	PW	8	3000	330.0	12.4	7.0	3.6	1.6	8.0	12.0	Q1
TLV9364QDRQ1	SOIC	D	14	3000	330.0	16.4	6.5	9.0	2.1	8.0	16.0	Q1
TLV9364QPWRQ1	TSSOP	PW	14	3000	330.0	12.4	6.9	5.6	1.6	8.0	12.0	Q1

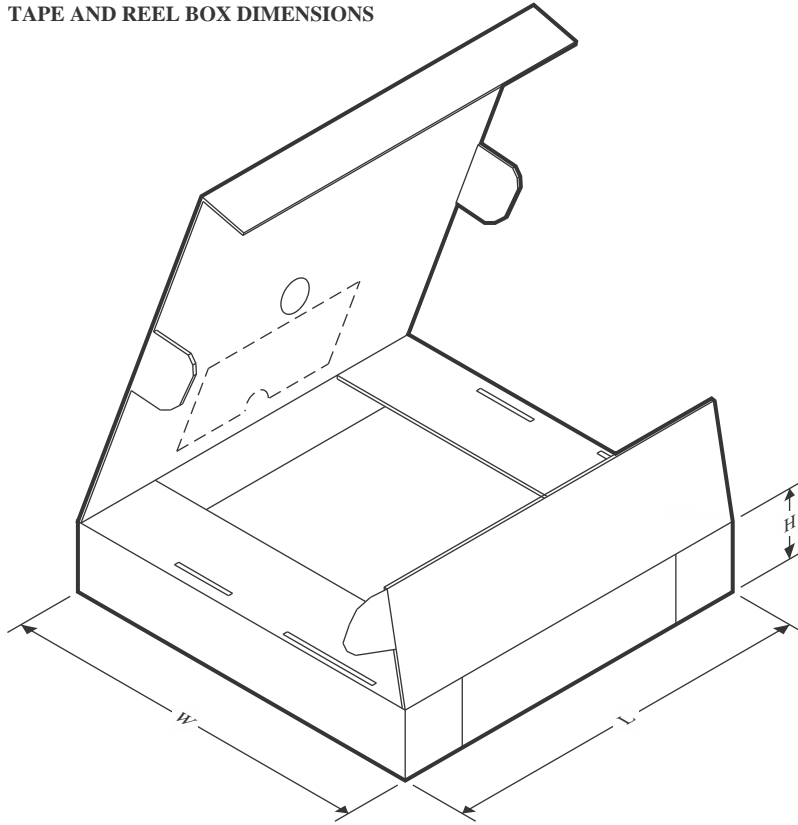
TAPE AND REEL BOX DIMENSIONS

*All dimensions are nominal

Device	Package Type	Package Drawing	Pins	SPQ	Length (mm)	Width (mm)	Height (mm)
TLV9361QDBVRQ1	SOT-23	DBV	5	3000	210.0	185.0	35.0
TLV9361QDCKRQ1	SC70	DCK	5	3000	180.0	180.0	18.0
TLV9362QDGKRQ1	VSSOP	DGK	8	2500	366.0	364.0	50.0
TLV9362QDRQ1	SOIC	D	8	3000	356.0	356.0	35.0
TLV9362QPWRQ1	TSSOP	PW	8	3000	353.0	353.0	32.0
TLV9364QDRQ1	SOIC	D	14	3000	356.0	356.0	35.0
TLV9364QPWRQ1	TSSOP	PW	14	3000	356.0	356.0	35.0

**DBV0005A****PACKAGE OUTLINE****SOT-23 - 1.45 mm max height**

SMALL OUTLINE TRANSISTOR

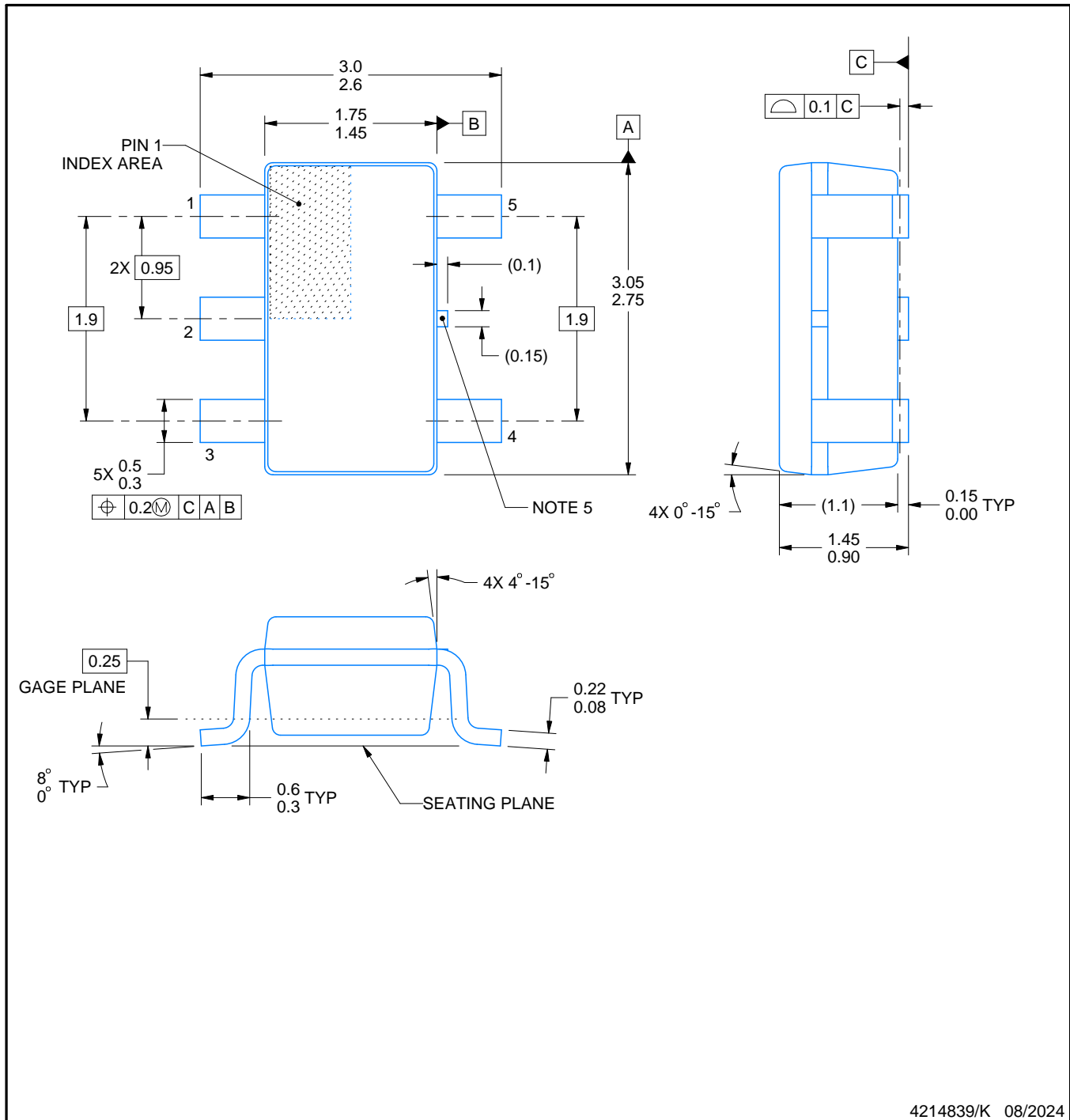

4214839/K 08/2024

NOTES:

- All linear dimensions are in millimeters. Any dimensions in parenthesis are for reference only. Dimensioning and tolerancing per ASME Y14.5M.
- This drawing is subject to change without notice.
- Reference JEDEC MO-178.
- Body dimensions do not include mold flash, protrusions, or gate burrs. Mold flash, protrusions, or gate burrs shall not exceed 0.25 mm per side.
- Support pin may differ or may not be present.

EXAMPLE BOARD LAYOUT

DBV0005A

SOT-23 - 1.45 mm max height

SMALL OUTLINE TRANSISTOR

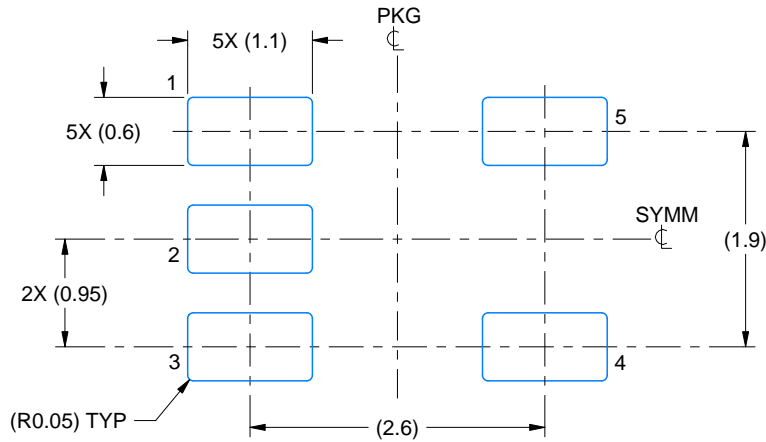

LAND PATTERN EXAMPLE
EXPOSED METAL SHOWN
SCALE:15X

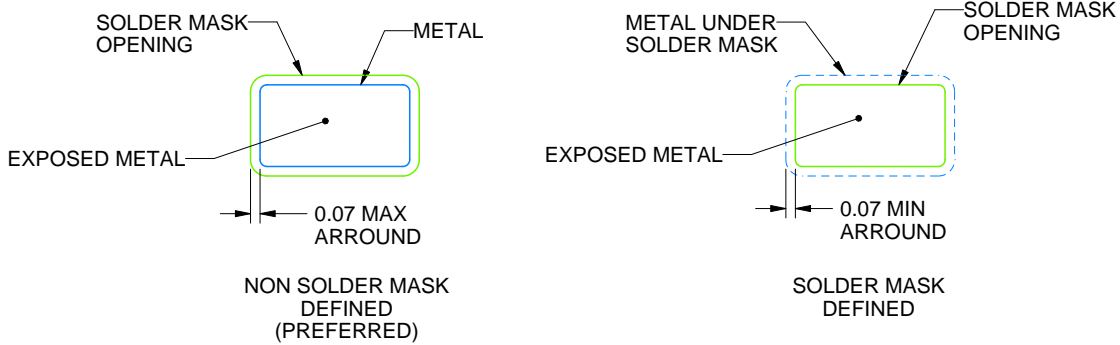

SOLDER MASK DETAILS

4214839/K 08/2024

NOTES: (continued)

- 6. Publication IPC-7351 may have alternate designs.
- 7. Solder mask tolerances between and around signal pads can vary based on board fabrication site.

EXAMPLE STENCIL DESIGN**DBV0005A****SOT-23 - 1.45 mm max height**

SMALL OUTLINE TRANSISTOR

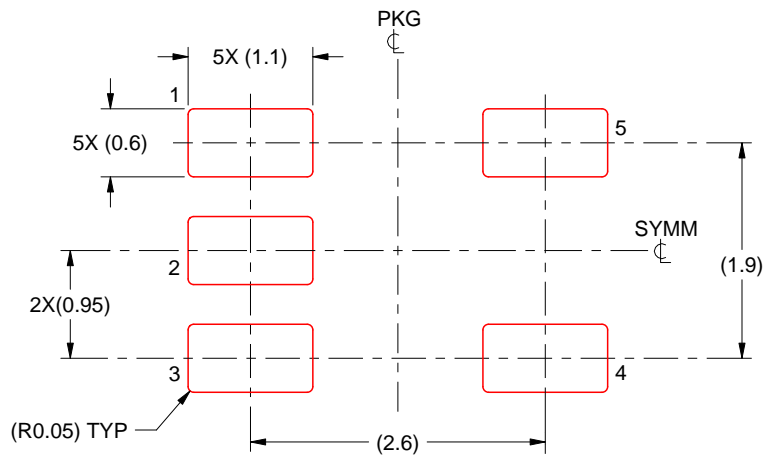

SOLDER PASTE EXAMPLE
 BASED ON 0.125 mm THICK STENCIL
 SCALE:15X

4214839/K 08/2024

NOTES: (continued)

8. Laser cutting apertures with trapezoidal walls and rounded corners may offer better paste release. IPC-7525 may have alternate design recommendations.
9. Board assembly site may have different recommendations for stencil design.



DGK0008A

PACKAGE OUTLINE

VSSOP - 1.1 mm max height

SMALL OUTLINE PACKAGE

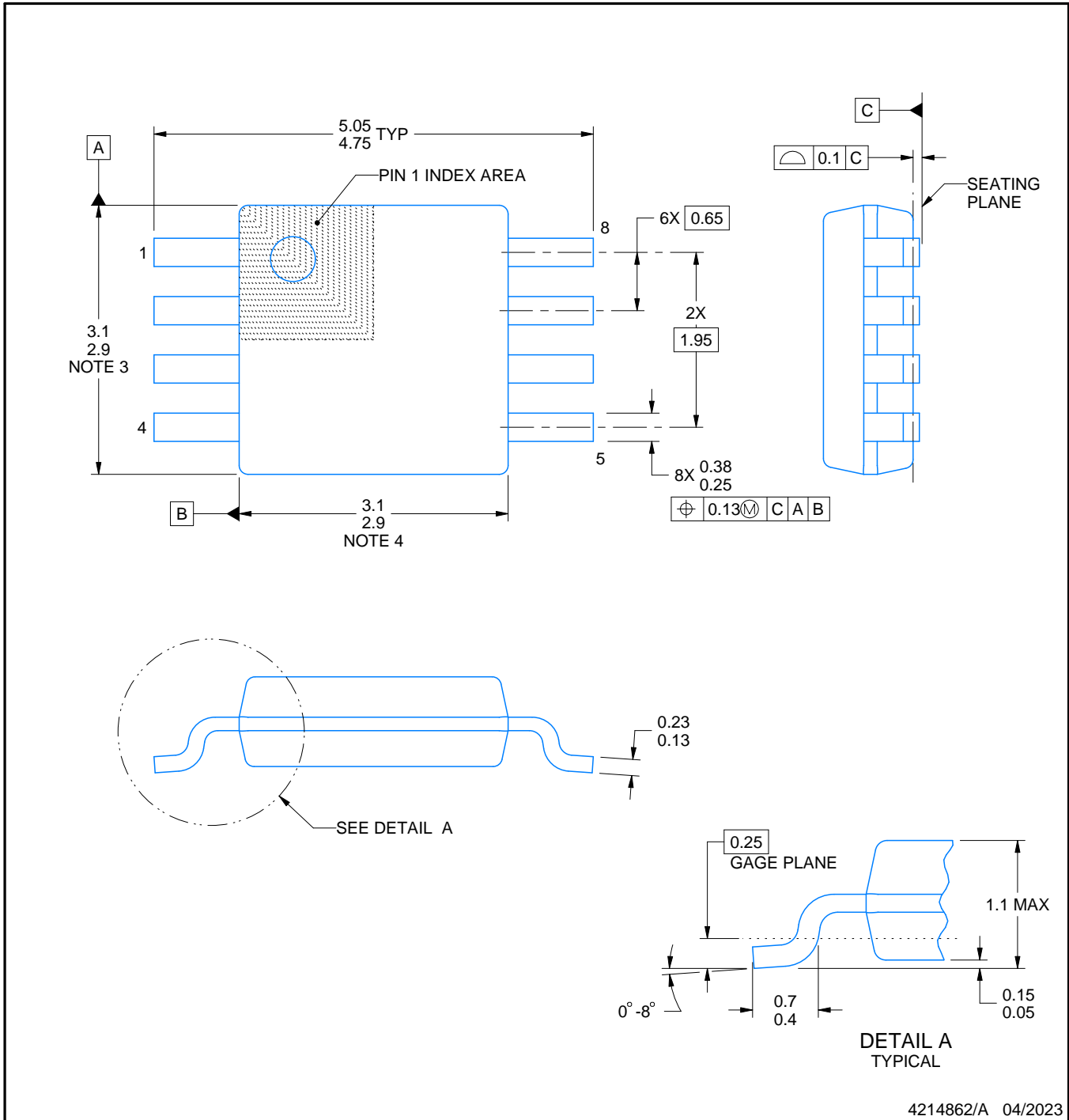

4214862/A 04/2023

NOTES:

PowerPAD is a trademark of Texas Instruments.

1. All linear dimensions are in millimeters. Any dimensions in parenthesis are for reference only. Dimensioning and tolerancing per ASME Y14.5M.
2. This drawing is subject to change without notice.
3. This dimension does not include mold flash, protrusions, or gate burrs. Mold flash, protrusions, or gate burrs shall not exceed 0.15 mm per side.
4. This dimension does not include interlead flash. Interlead flash shall not exceed 0.25 mm per side.
5. Reference JEDEC registration MO-187.

EXAMPLE BOARD LAYOUT

DGK0008A

™ VSSOP - 1.1 mm max height

SMALL OUTLINE PACKAGE

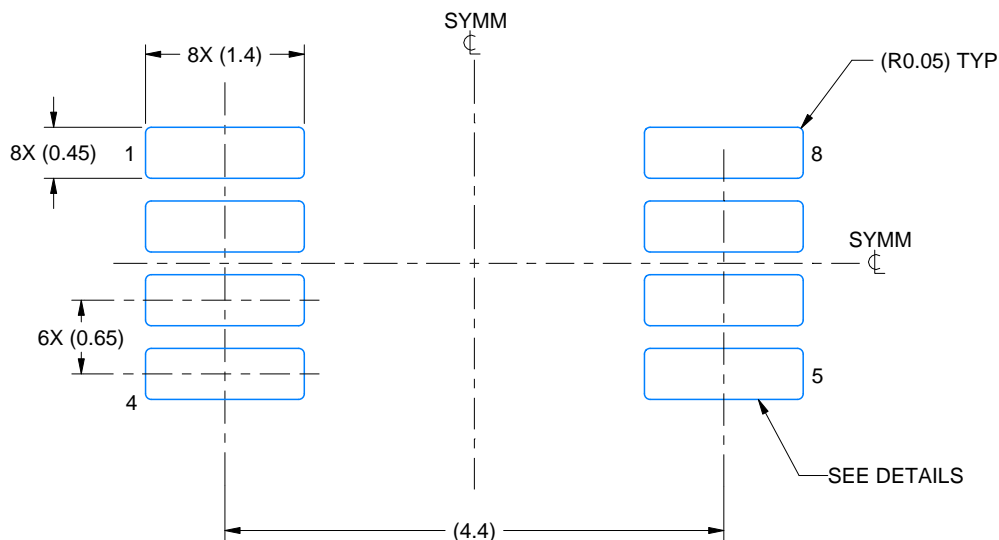

LAND PATTERN EXAMPLE
EXPOSED METAL SHOWN
SCALE: 15X

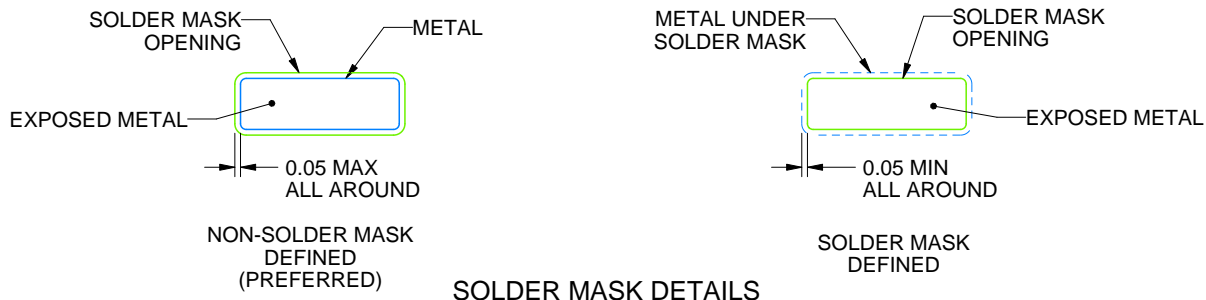

SOLDER MASK DETAILS

4214862/A 04/2023

NOTES: (continued)

- 6. Publication IPC-7351 may have alternate designs.
- 7. Solder mask tolerances between and around signal pads can vary based on board fabrication site.
- 8. Vias are optional depending on application, refer to device data sheet. If any vias are implemented, refer to their locations shown on this view. It is recommended that vias under paste be filled, plugged or tented.
- 9. Size of metal pad may vary due to creepage requirement.

EXAMPLE STENCIL DESIGN

DGK0008A

™ VSSOP - 1.1 mm max height

SMALL OUTLINE PACKAGE

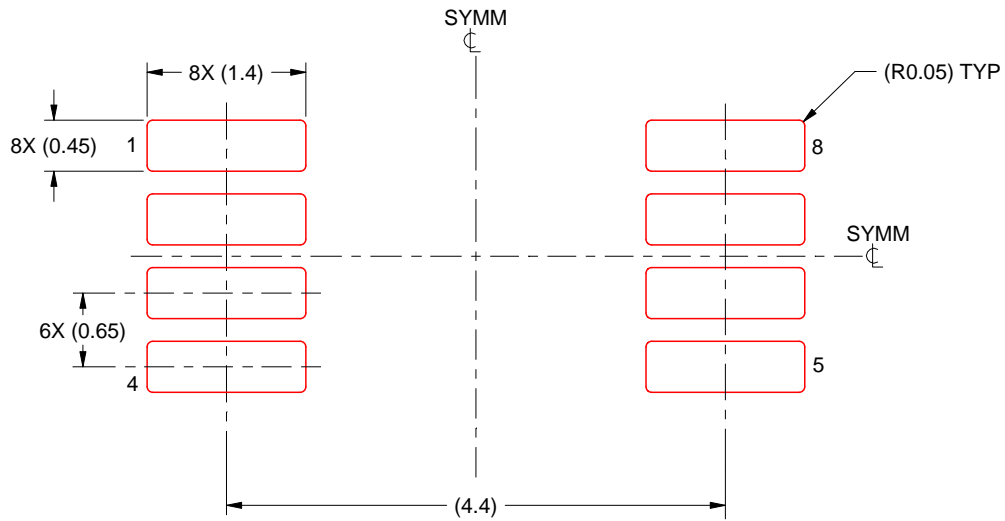

SOLDER PASTE EXAMPLE
SCALE: 15X

4214862/A 04/2023

NOTES: (continued)

11. Laser cutting apertures with trapezoidal walls and rounded corners may offer better paste release. IPC-7525 may have alternate design recommendations.
12. Board assembly site may have different recommendations for stencil design.

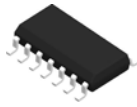

D0014A

PACKAGE OUTLINE

SOIC - 1.75 mm max height

SMALL OUTLINE INTEGRATED CIRCUIT

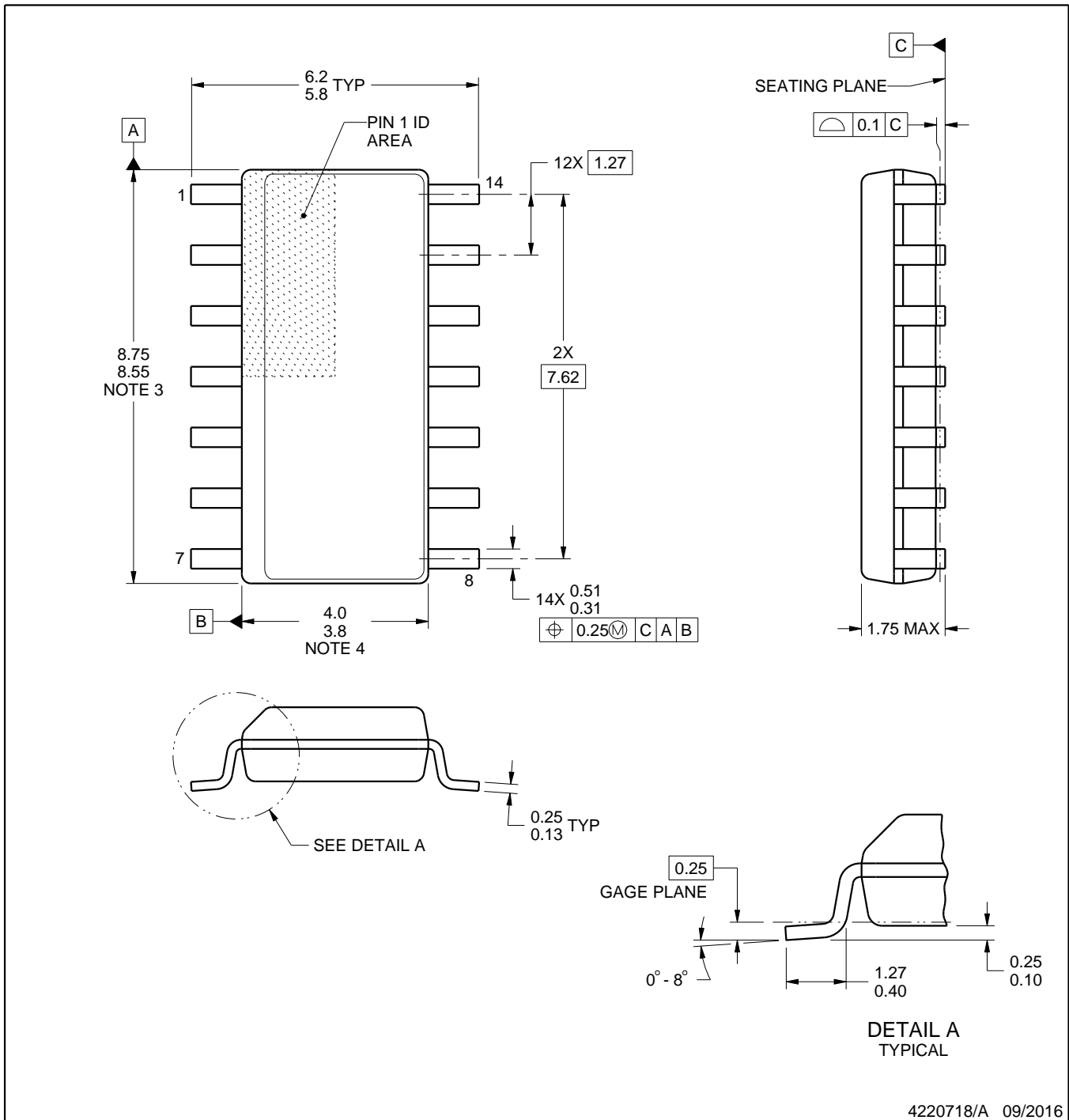

4220718/A 09/2016

NOTES:

1. All linear dimensions are in millimeters. Dimensions in parenthesis are for reference only. Dimensioning and tolerancing per ASME Y14.5M.
2. This drawing is subject to change without notice.
3. This dimension does not include mold flash, protrusions, or gate burrs. Mold flash, protrusions, or gate burrs shall not exceed 0.15 mm, per side.
4. This dimension does not include interlead flash. Interlead flash shall not exceed 0.43 mm, per side.
5. Reference JEDEC registration MS-012, variation AB.

EXAMPLE BOARD LAYOUT

D0014A

SOIC - 1.75 mm max height

SMALL OUTLINE INTEGRATED CIRCUIT

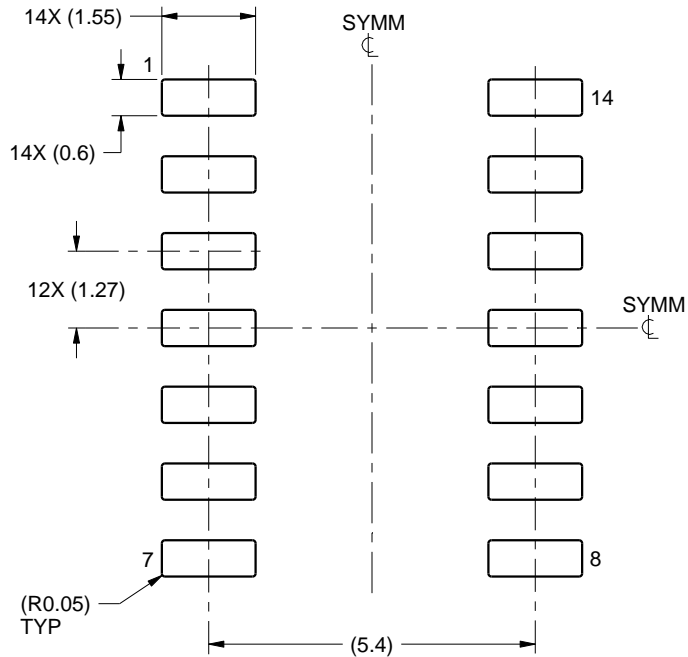

LAND PATTERN EXAMPLE
SCALE:8X

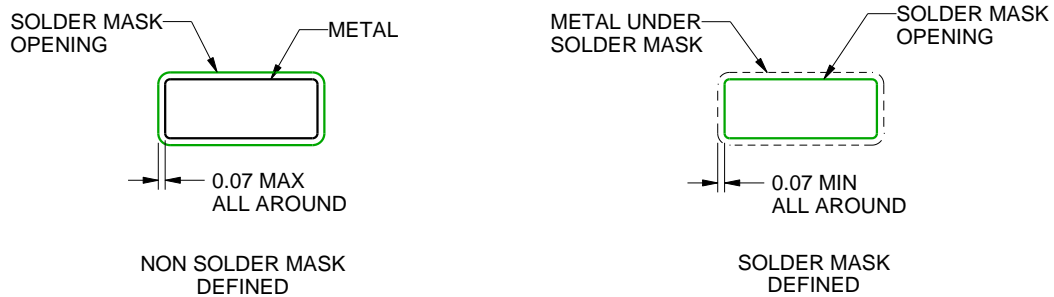

SOLDER MASK DETAILS

4220718/A 09/2016

NOTES: (continued)

- 6. Publication IPC-7351 may have alternate designs.
- 7. Solder mask tolerances between and around signal pads can vary based on board fabrication site.

EXAMPLE STENCIL DESIGN**D0014A****SOIC - 1.75 mm max height**

SMALL OUTLINE INTEGRATED CIRCUIT

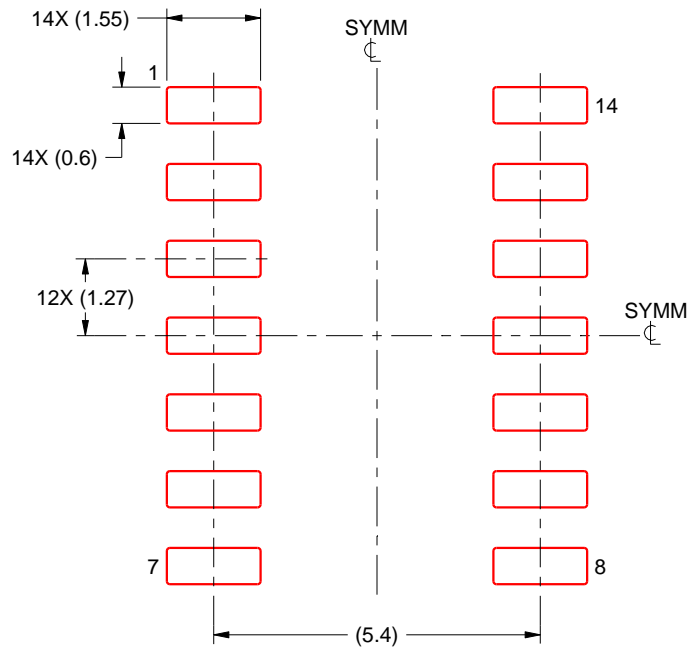

SOLDER PASTE EXAMPLE
 BASED ON 0.125 mm THICK STENCIL
 SCALE:8X

4220718/A 09/2016

NOTES: (continued)

8. Laser cutting apertures with trapezoidal walls and rounded corners may offer better paste release. IPC-7525 may have alternate design recommendations.
9. Board assembly site may have different recommendations for stencil design.



PACKAGE OUTLINE

DCK0005A

SOT - 1.1 max height

SMALL OUTLINE TRANSISTOR

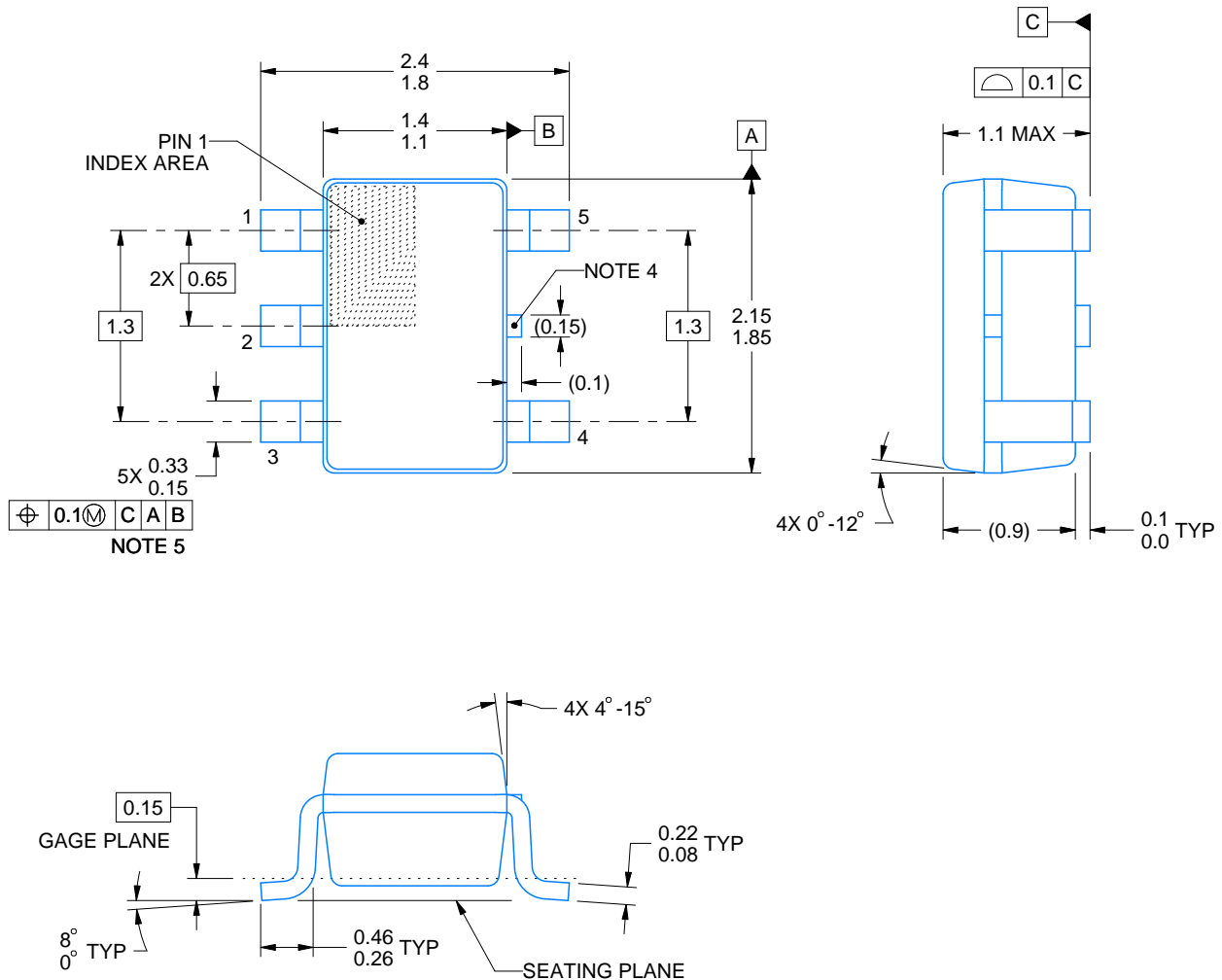

4214834/G 11/2024

NOTES:

- All linear dimensions are in millimeters. Any dimensions in parenthesis are for reference only. Dimensioning and tolerancing per ASME Y14.5M.
- This drawing is subject to change without notice.
- Reference JEDEC MO-203.
- Support pin may differ or may not be present.
- Lead width does not comply with JEDEC.
- Body dimensions do not include mold flash, protrusions, or gate burrs. Mold flash, protrusions, or gate burrs shall not exceed 0.25mm per side

EXAMPLE BOARD LAYOUT

DCK0005A

SOT - 1.1 max height

SMALL OUTLINE TRANSISTOR

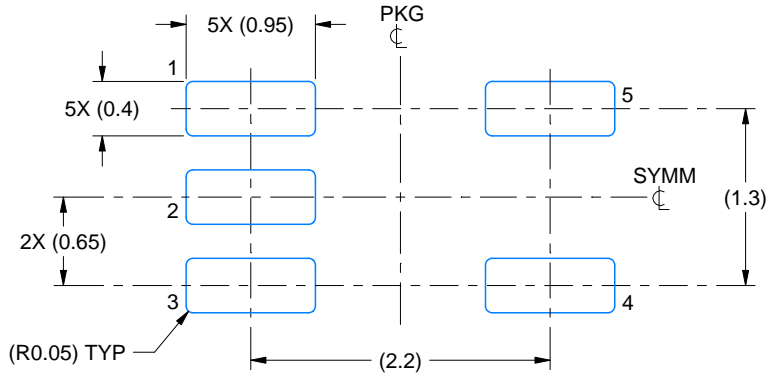

LAND PATTERN EXAMPLE
EXPOSED METAL SHOWN
SCALE:18X

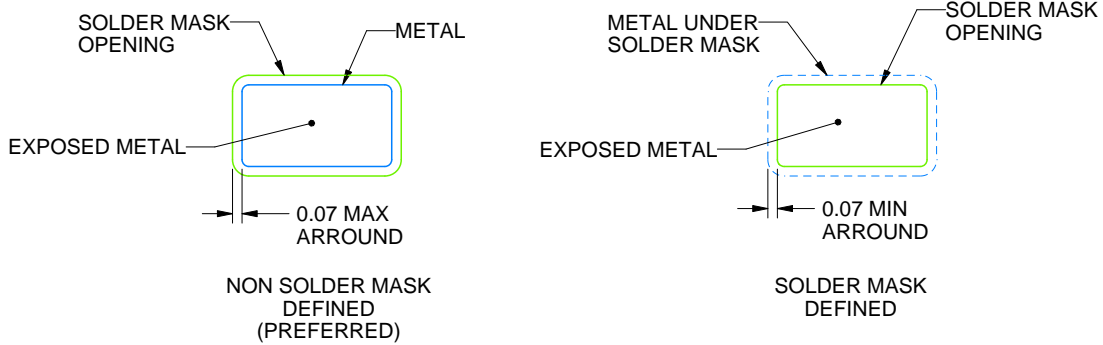

SOLDER MASK DETAILS

4214834/G 11/2024

NOTES: (continued)

- 7. Publication IPC-7351 may have alternate designs.
- 8. Solder mask tolerances between and around signal pads can vary based on board fabrication site.

EXAMPLE STENCIL DESIGN**DCK0005A****SOT - 1.1 max height**

SMALL OUTLINE TRANSISTOR

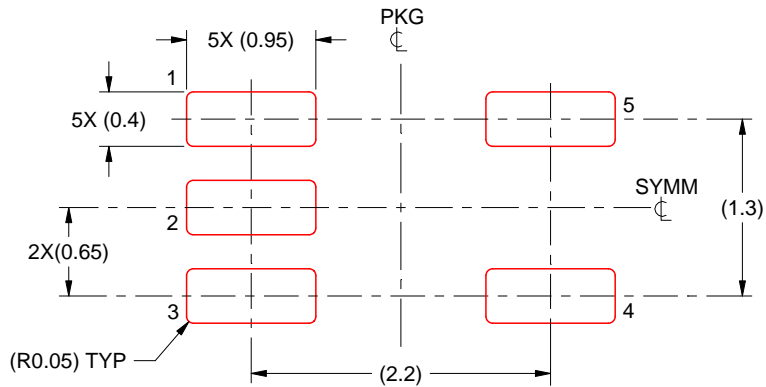

SOLDER PASTE EXAMPLE
 BASED ON 0.125 THICK STENCIL
 SCALE:18X

4214834/G 11/2024

NOTES: (continued)

9. Laser cutting apertures with trapezoidal walls and rounded corners may offer better paste release. IPC-7525 may have alternate design recommendations.
10. Board assembly site may have different recommendations for stencil design.

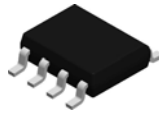

D0008A

PACKAGE OUTLINE

SOIC - 1.75 mm max height

SMALL OUTLINE INTEGRATED CIRCUIT

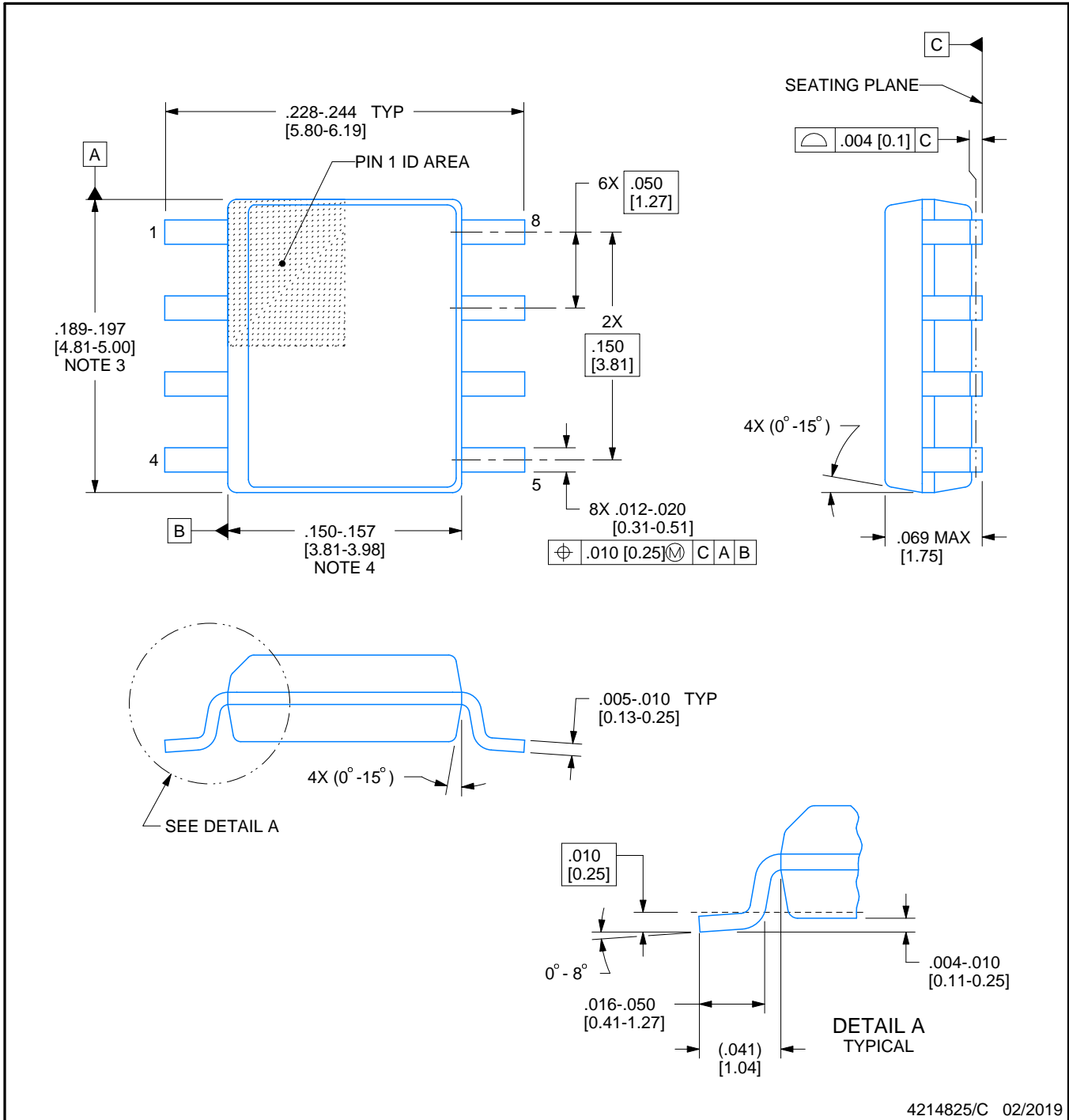

4214825/C 02/2019

NOTES:

1. Linear dimensions are in inches [millimeters]. Dimensions in parenthesis are for reference only. Controlling dimensions are in inches. Dimensioning and tolerancing per ASME Y14.5M.
2. This drawing is subject to change without notice.
3. This dimension does not include mold flash, protrusions, or gate burrs. Mold flash, protrusions, or gate burrs shall not exceed .006 [0.15] per side.
4. This dimension does not include interlead flash.
5. Reference JEDEC registration MS-012, variation AA.

EXAMPLE BOARD LAYOUT

D0008A

SOIC - 1.75 mm max height

SMALL OUTLINE INTEGRATED CIRCUIT

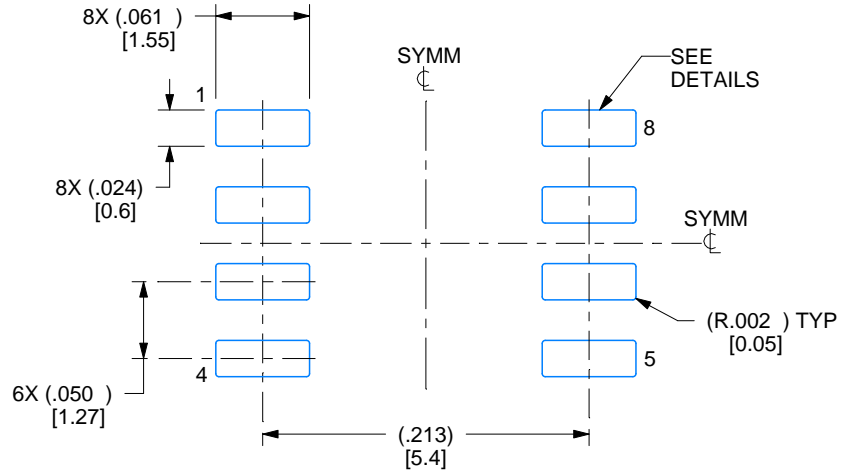

LAND PATTERN EXAMPLE
 EXPOSED METAL SHOWN
 SCALE:8X

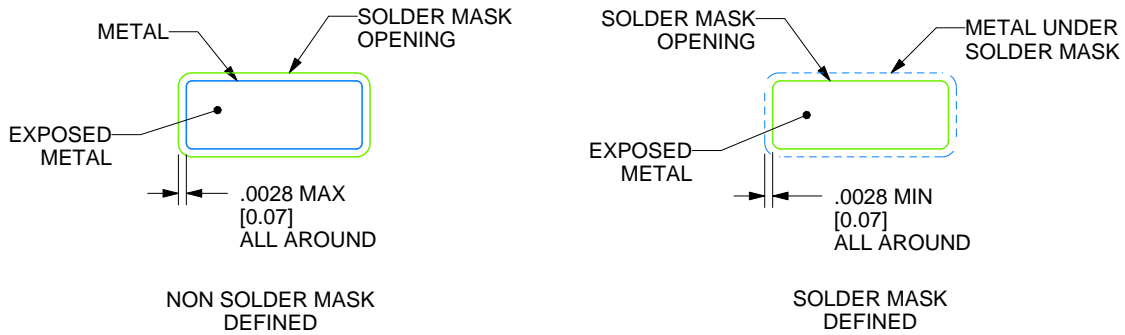

SOLDER MASK DETAILS

4214825/C 02/2019

NOTES: (continued)

- 6. Publication IPC-7351 may have alternate designs.
- 7. Solder mask tolerances between and around signal pads can vary based on board fabrication site.

EXAMPLE STENCIL DESIGN**D0008A****SOIC - 1.75 mm max height**

SMALL OUTLINE INTEGRATED CIRCUIT

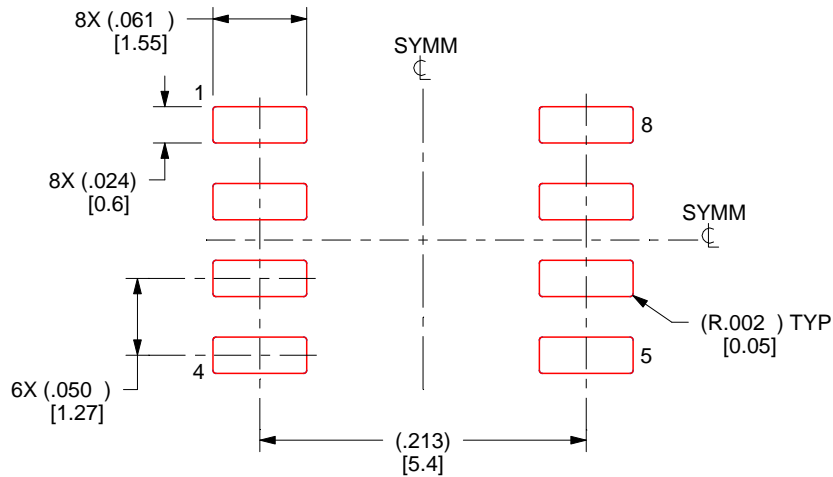

SOLDER PASTE EXAMPLE
 BASED ON .005 INCH [0.125 MM] THICK STENCIL
 SCALE:8X

4214825/C 02/2019

NOTES: (continued)

8. Laser cutting apertures with trapezoidal walls and rounded corners may offer better paste release. IPC-7525 may have alternate design recommendations.
9. Board assembly site may have different recommendations for stencil design.

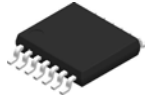

PACKAGE OUTLINE

PW0014A

TSSOP - 1.2 mm max height

SMALL OUTLINE PACKAGE

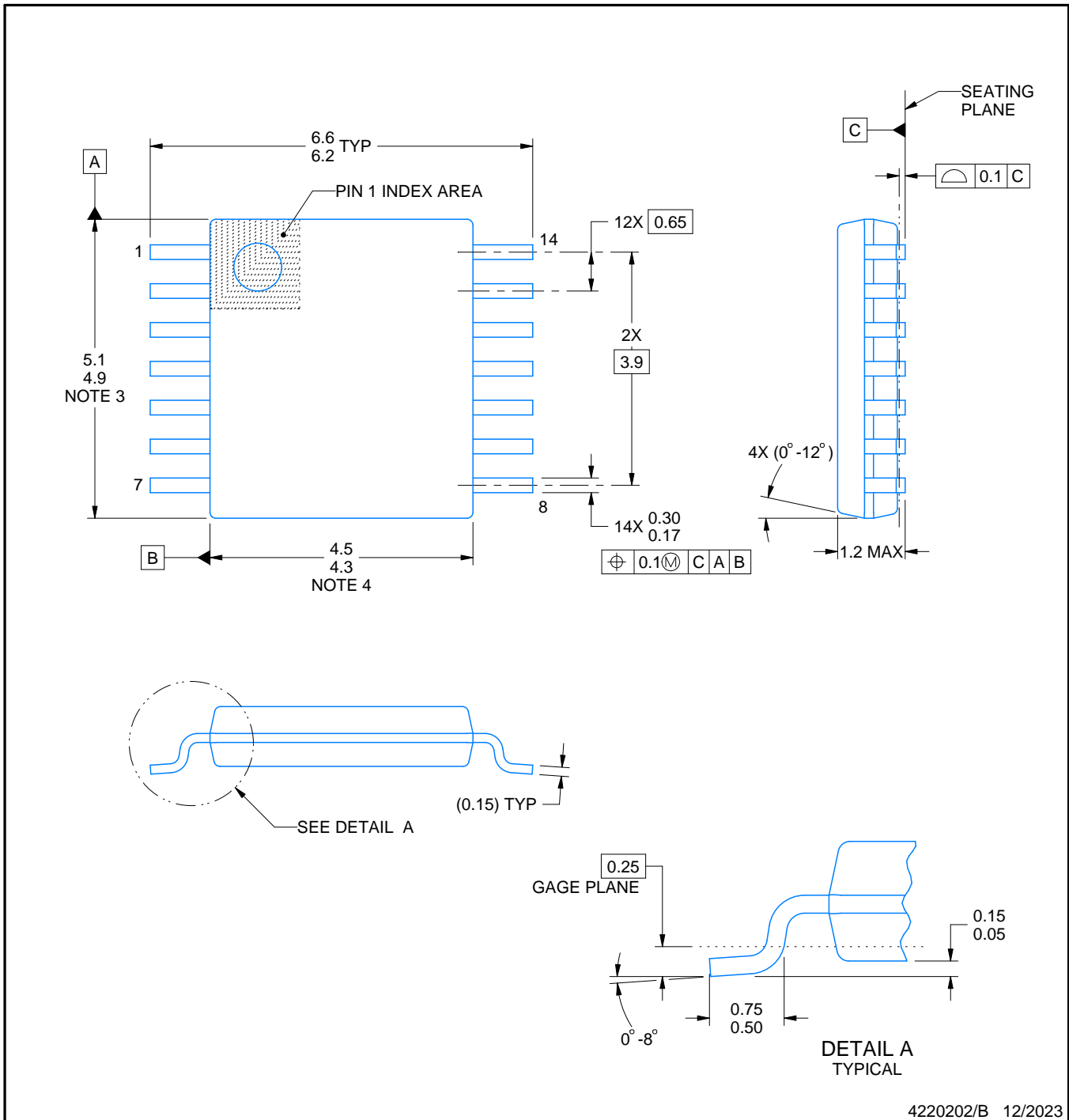

4220202/B 12/2023

NOTES:

- All linear dimensions are in millimeters. Any dimensions in parenthesis are for reference only. Dimensioning and tolerancing per ASME Y14.5M.
- This drawing is subject to change without notice.
- This dimension does not include mold flash, protrusions, or gate burrs. Mold flash, protrusions, or gate burrs shall not exceed 0.15 mm per side.
- This dimension does not include interlead flash. Interlead flash shall not exceed 0.25 mm per side.
- Reference JEDEC registration MO-153.

EXAMPLE BOARD LAYOUT

PW0014A

TSSOP - 1.2 mm max height

SMALL OUTLINE PACKAGE

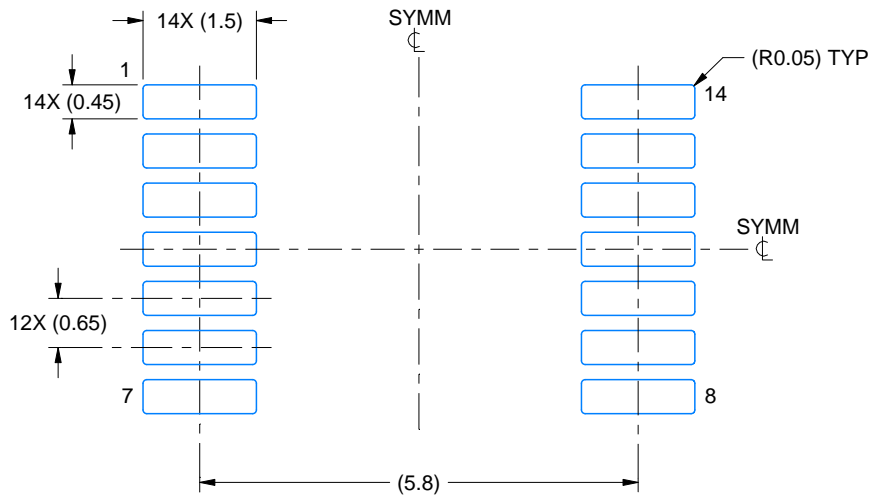

LAND PATTERN EXAMPLE
EXPOSED METAL SHOWN
SCALE: 10X

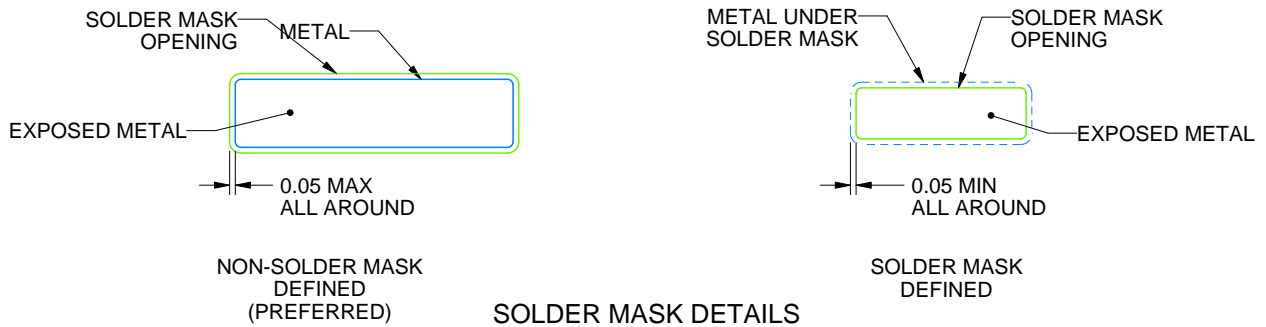

4220202/B 12/2023

NOTES: (continued)

- 6. Publication IPC-7351 may have alternate designs.
- 7. Solder mask tolerances between and around signal pads can vary based on board fabrication site.

EXAMPLE STENCIL DESIGN

PW0014A

TSSOP - 1.2 mm max height

SMALL OUTLINE PACKAGE

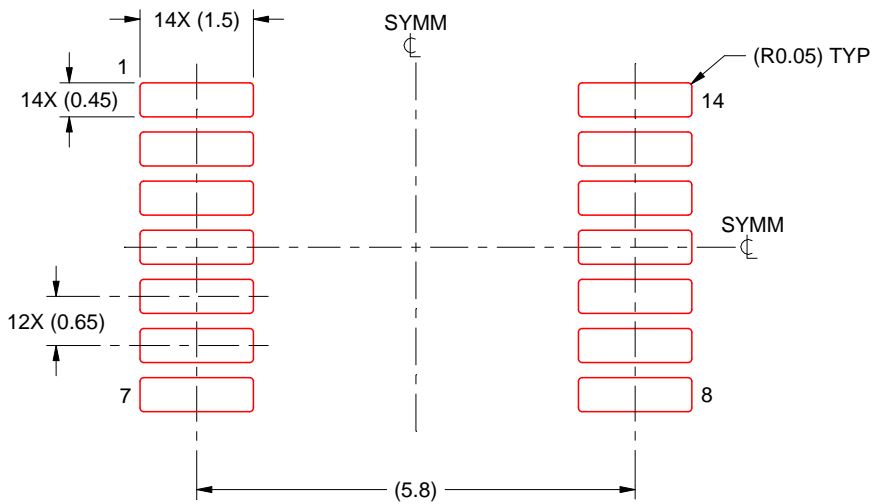

SOLDER PASTE EXAMPLE
 BASED ON 0.125 mm THICK STENCIL
 SCALE: 10X

4220202/B 12/2023

NOTES: (continued)

- 8. Laser cutting apertures with trapezoidal walls and rounded corners may offer better paste release. IPC-7525 may have alternate design recommendations.
- 9. Board assembly site may have different recommendations for stencil design.

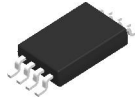

PW0008A

PACKAGE OUTLINE

TSSOP - 1.2 mm max height

SMALL OUTLINE PACKAGE

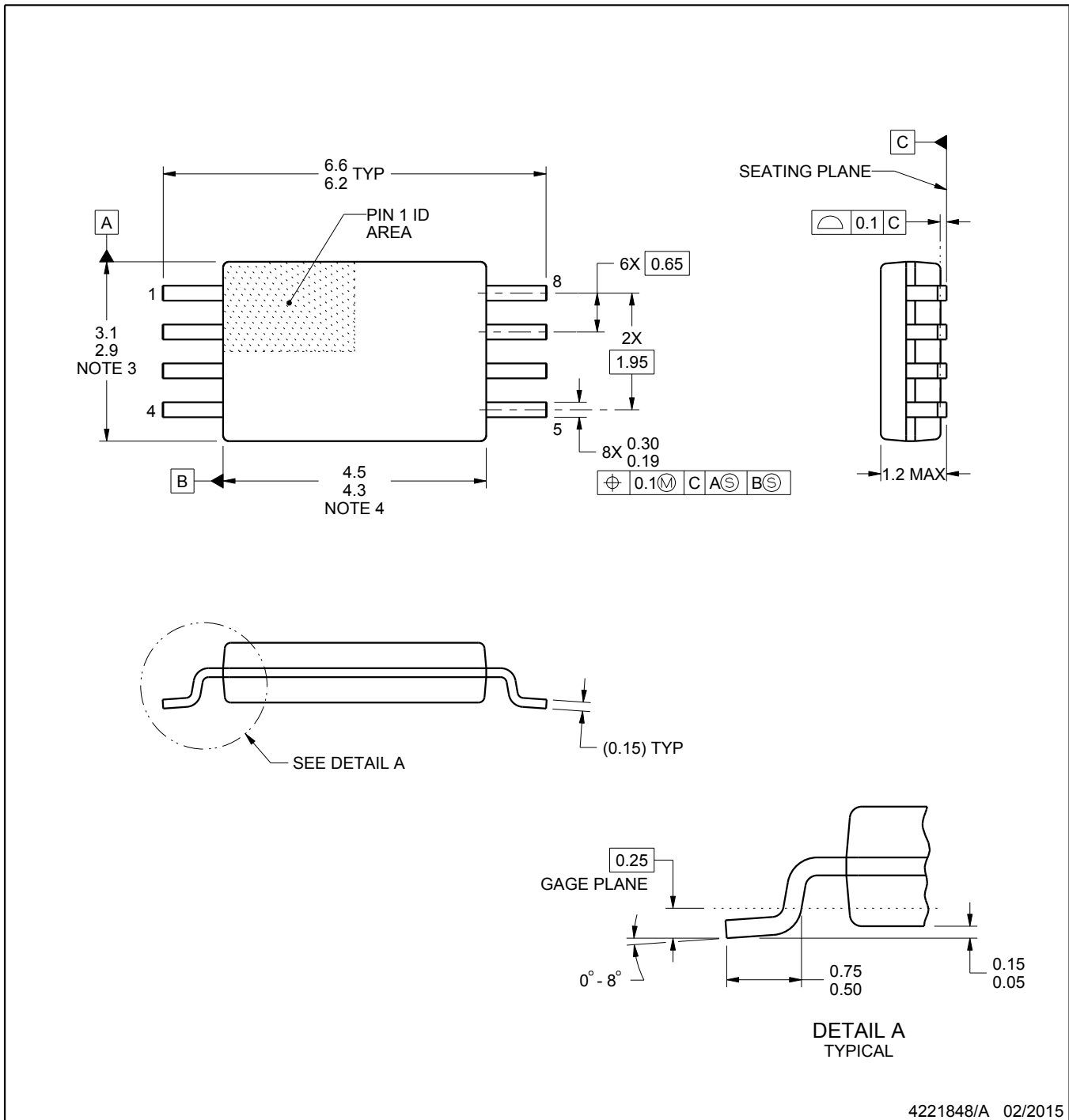

NOTES:

- All linear dimensions are in millimeters. Any dimensions in parenthesis are for reference only. Dimensioning and tolerancing per ASME Y14.5M.
- This drawing is subject to change without notice.
- This dimension does not include mold flash, protrusions, or gate burrs. Mold flash, protrusions, or gate burrs shall not exceed 0.15 mm per side.
- This dimension does not include interlead flash. Interlead flash shall not exceed 0.25 mm per side.
- Reference JEDEC registration MO-153, variation AA.

EXAMPLE BOARD LAYOUT

PW0008A

TSSOP - 1.2 mm max height

SMALL OUTLINE PACKAGE

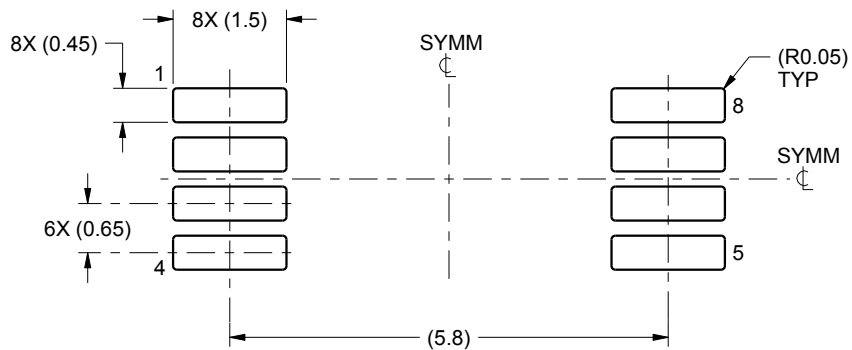

LAND PATTERN EXAMPLE
SCALE:10X

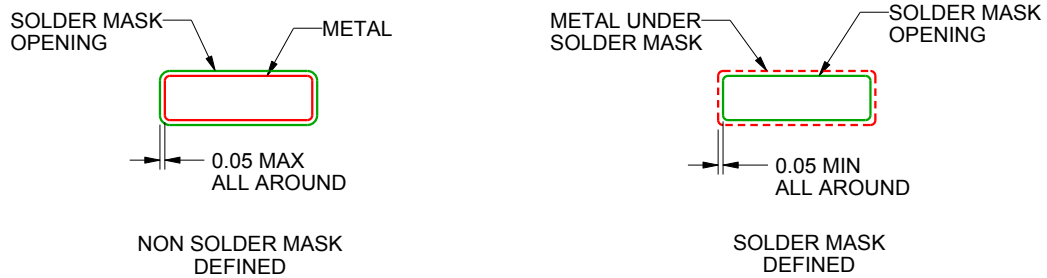

SOLDER MASK DETAILS
NOT TO SCALE

4221848/A 02/2015

NOTES: (continued)

- 6. Publication IPC-7351 may have alternate designs.
- 7. Solder mask tolerances between and around signal pads can vary based on board fabrication site.

EXAMPLE STENCIL DESIGN**PW0008A****TSSOP - 1.2 mm max height**

SMALL OUTLINE PACKAGE

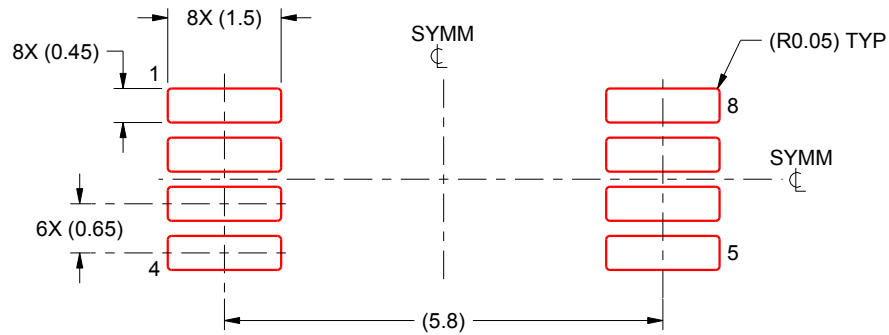

SOLDER PASTE EXAMPLE
 BASED ON 0.125 mm THICK STENCIL
 SCALE:10X

4221848/A 02/2015

NOTES: (continued)

8. Laser cutting apertures with trapezoidal walls and rounded corners may offer better paste release. IPC-7525 may have alternate design recommendations.
9. Board assembly site may have different recommendations for stencil design.

IMPORTANT NOTICE AND DISCLAIMER

TI PROVIDES TECHNICAL AND RELIABILITY DATA (INCLUDING DATA SHEETS), DESIGN RESOURCES (INCLUDING REFERENCE DESIGNS), APPLICATION OR OTHER DESIGN ADVICE, WEB TOOLS, SAFETY INFORMATION, AND OTHER RESOURCES "AS IS" AND WITH ALL FAULTS, AND DISCLAIMS ALL WARRANTIES, EXPRESS AND IMPLIED, INCLUDING WITHOUT LIMITATION ANY IMPLIED WARRANTIES OF MERCHANTABILITY, FITNESS FOR A PARTICULAR PURPOSE OR NON-INFRINGEMENT OF THIRD PARTY INTELLECTUAL PROPERTY RIGHTS.

These resources are intended for skilled developers designing with TI products. You are solely responsible for (1) selecting the appropriate TI products for your application, (2) designing, validating and testing your application, and (3) ensuring your application meets applicable standards, and any other safety, security, regulatory or other requirements.

These resources are subject to change without notice. TI grants you permission to use these resources only for development of an application that uses the TI products described in the resource. Other reproduction and display of these resources is prohibited. No license is granted to any other TI intellectual property right or to any third party intellectual property right. TI disclaims responsibility for, and you will fully indemnify TI and its representatives against, any claims, damages, costs, losses, and liabilities arising out of your use of these resources.

TI's products are provided subject to [TI's Terms of Sale](#) or other applicable terms available either on [ti.com](https://www.ti.com) or provided in conjunction with such TI products. TI's provision of these resources does not expand or otherwise alter TI's applicable warranties or warranty disclaimers for TI products.

TI objects to and rejects any additional or different terms you may have proposed.

Mailing Address: Texas Instruments, Post Office Box 655303, Dallas, Texas 75265

Copyright © 2025, Texas Instruments Incorporated

OUR CERTIFICATE

DiGi provide top-quality products and perfect service for customer worldwide through standardization, technological innovation and continuous improvement. DiGi through third-party certification, we stricly control the quality of products and services. Welcome your RFQ to

Email: Info@DiGi-Electronics.com



Tel: +00 852-30501935

RFQ Email: Info@DiGi-Electronics.com

DiGi is a global authorized distributor of electronic components.