

TPS76615D Datasheet

www.digi-electronics.com

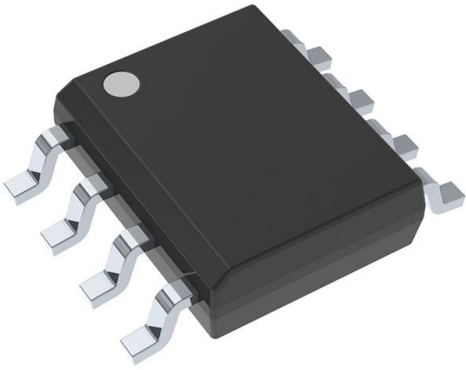

<https://www.DiGi-Electronics.com>

DiGi Electronics Part Number	TPS76615D-DG
Manufacturer	Texas Instruments
Manufacturer Product Number	TPS76615D
Description	IC REG LINEAR 1.5V 250MA 8SOIC
Detailed Description	Linear Voltage Regulator IC Positive Fixed 1 Output 250mA 8-SOIC

This model TPS76615D is available at DiGi Electronics.

DiGi Electronics offers a global database of semiconductor and electronic component datasheets.

We welcome your inquiries regarding pricing, lead time, or other product-related questions.

 [Request a Quote](#)

 [Datasheet Search](#)



Tel: +00 852-30501935

RFQ Email: Info@DiGi-Electronics.com

DiGi is a global authorized distributor of electronic components.

Purchase and inquiry

Manufacturer Product Number:

TPS76615D

Series:

-

Output Configuration:

Positive

Number of Regulators:

1

Voltage - Output (Min/Fixed):

1.5V

Voltage Dropout (Max):

-

Current - Quiescent (Iq):

50 μ A

Control Features:

Enable, Power Good

Operating Temperature:

-40°C ~ 125°C

Package / Case:

8-SOIC (0.154", 3.90mm Width)

Base Product Number:

TPS76615

Manufacturer:

Texas Instruments

Product Status:

Active

Output Type:

Fixed

Voltage - Input (Max):

10V

Voltage - Output (Max):

-

Current - Output:

250mA

PSRR:

63dB (1kHz)

Protection Features:

Over Current, Over Temperature, Reverse Polarity

Mounting Type:

Surface Mount

Supplier Device Package:

8-SOIC

Environmental & Export classification

RoHS Status:

ROHS3 Compliant

REACH Status:

REACH Unaffected

HTSUS:

8542.39.0001

Moisture Sensitivity Level (MSL):

1 (Unlimited)

ECCN:

EAR99

TPS766 250mA, 16V, Low-Dropout Voltage Regulator

1 Features

- Input voltage range:
 - Legacy chip: 2.7V to 10V (13.5V absolute max)
 - New chip: 2.5V to 16V (18V absolute max)
- Output voltage range:
 - Legacy chip: 1.5V to 5V (fixed) and 1.25V to 5.5V (adjustable)
 - New chip: 1.2V to 12V (fixed) and 0.8V to 14.6V (adjustable)
- Output current: Up to 250mA
- Output accuracy:
 - Legacy chip: 3% over load and temperature
 - New chip: 1% over load and temperature
- Low quiescent current (I_Q):
 - Legacy chip: 35 μ A (typ) with no load
 - New chip: 55 μ A (typ) with no load
- I_Q (disabled state):
 - Legacy chip: 10 μ A (max)
 - New chip: 4 μ A (max)
- Dropout voltage (new chip):
 - Up to 225mV (typ) at 250mA (TPS76650)
- High PSRR (new chip): 46dB at 1MHz
- Internal soft-start time (new chip): 750 μ s (typical)
- Overcurrent limiting and thermal protection
- Stable with a 2.2 μ F or larger capacitor (new chip)
- Open-drain power-good
- Package: 8-pin, 4.9mm \times 6mm SOIC (D)

2 Applications

- Residential air conditioners
- Body electronics and lighting
- HVAC systems
- Washers and dryers

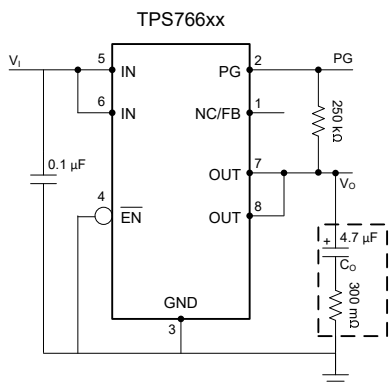

Typical Application Circuit

3 Description

The TPS766 is a low-dropout (LDO) linear voltage regulator that supports an input voltage range from 2.5V to 16V (new chip) and up to 250mA of load current. For the new chip, the supported output range is from 1.2V to 12V (fixed version) or from 0.8V to 14.6V (adjustable version).

The input voltage range is up to 16V (new chip), which makes the device a good choice for operating from transformer secondary windings and regulated rails (such as 10V or 12V). Additionally, the wide output voltage range allows the device to generate the bias voltage for silicon carbide (SiC) gate drivers and microphones, as well as power microcontrollers (MCUs) and processors.

Wide bandwidth PSRR performance is greater than 70dB at 1kHz and 46dB at 1MHz (new chip), which helps attenuate the switching frequency of an upstream DC/DC converter and minimizes post regulator filtering. The new chip supports internal soft-start circuit mechanism that reduces inrush current during start-up, thus allowing for smaller input capacitance.

The legacy chip supports constant quiescent current across the complete load current range (typically 35 μ A for the full range of output current, 0mA to 250mA).

Package Information

PART NUMBER	PACKAGE ⁽¹⁾	PACKAGE SIZE ⁽²⁾
TPS766	D (SOIC, 8)	4.9mm \times 6mm

- For more information, see the [Mechanical, Packaging, and Orderable Information](#).
- The package size (length \times width) is a nominal value and includes pins, where applicable.

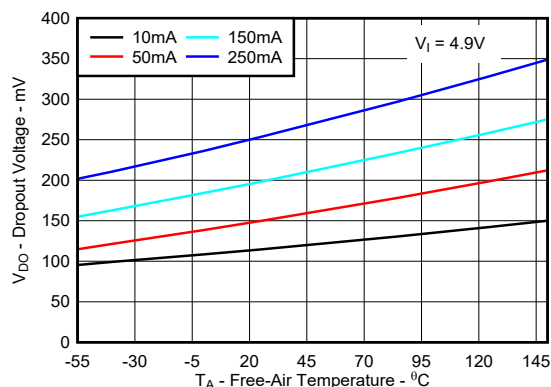

TPS76633 Dropout voltage vs Temperature (New Chip)



TPS766SLVS237E – AUGUST 1999 – REVISED MARCH 2024

The TPS766 LDO also features a sleep mode, where applying a TTL high signal to \overline{EN} (enable) shuts down the regulator. In disabled mode, the quiescent current for the legacy chip is less than $1\mu\text{A}$ (typ) and the quiescent current for the new chip is approximately $1.6\mu\text{A}$ (typ).

Power-good (PG) is an active-high output used to implement a power-on reset or a low-battery indicator.

For the fixed-output version, The TPS766 provides an output range of 1.5V to 5.0V (legacy chip) and 1.2V to 12V (new chip). For the adjustable version, program the output voltage over the range of 1.25V to 5.5V (legacy chip) and 0.8V to 14.6V (new chip). The TPS766 is available in an 8-pin SOIC package.

Table of Contents

1 Features	1	6.3 Feature Description.....	22
2 Applications	1	6.4 Device Functional Modes.....	25
3 Description	1	7 Application and Implementation	26
4 Pin Configuration and Functions	4	7.1 Application Information.....	26
5 Specifications	5	7.2 Typical Application.....	26
5.1 Absolute Maximum Ratings.....	5	7.3 Power Supply Recommendations.....	32
5.2 ESD Ratings.....	5	7.4 Layout.....	33
5.3 Recommended Operating Conditions.....	6	8 Device and Documentation Support	34
5.4 Thermal Information (Legacy Chip).....	6	8.1 Documentation Support.....	34
5.5 Thermal Information (New Chip).....	6	8.2 Receiving Notification of Documentation Updates....	34
5.6 Electrical Characteristics.....	7	8.3 Support Resources.....	34
5.7 Timing Diagram.....	9	8.4 Trademarks.....	34
5.8 Typical Characteristics.....	10	8.5 Electrostatic Discharge Caution.....	34
5.9 Typical Characteristics: Supported ESR Range.....	18	8.6 Glossary.....	34
6 Detailed Description	21	9 Revision History	34
6.1 Overview.....	21	10 Mechanical, Packaging, and Orderable Information	35
6.2 Functional Block Diagrams.....	21		

TPS766

SLVS237E – AUGUST 1999 – REVISED MARCH 2024

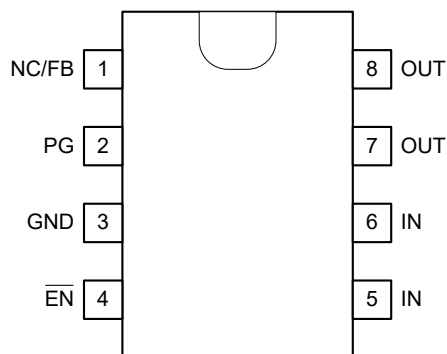
4 Pin Configuration and Functions**Figure 4-1. D Package, 8-Pin SOIC (Top View)****Pin Functions**

PIN		TYPE	DESCRIPTION
NAME	NO.		
$\overline{\text{EN}}$	4	I	Enable pin. Driving the enable pin low enables the device. Driving this pin high disables the device. Low and high thresholds are listed in the Electrical Characteristics table.
FB/NC	1	I	Adjustable version: Feedback pin. Input to the control-loop error amplifier. This pin sets the output voltage of the device by using external resistors. Do not float this pin. Fixed version: Not internally connected. Leave this pin open or tied to ground for improved thermal performance.
GND	3		Ground pin.
IN	5, 6	I	Input pin. Use the recommended capacitor value as listed in the Recommended Operating Conditions . Place the input capacitor as close to the IN and GND pins of the device as possible.
OUT	7, 8	O	Output pin. Use the recommended capacitor value as listed in the Recommended Operating Conditions . Place the output capacitor as close to the OUT and GND pins of the device as possible.
PG	2	O	Power-good output. Available in the open-drain output. A pullup resistor is required for the open-drain output type. If the power-good functionality is not used, ground this pin or leave floating. See the Power-Good Function section for more information.

5 Specifications

5.1 Absolute Maximum Ratings

over operating free-air temperature range (unless otherwise noted)⁽¹⁾

		MIN	MAX	UNIT
Voltage ⁽²⁾	V _{IN} (for legacy chip)	-0.3	13.5	V
	V _{IN} (for new chip)	-0.3	18	
	V _{OUT} (for legacy chip)	-0.3	7	
	V _{OUT} (for new chip)	-0.3	V _{IN} + 0.3	
	V _{FB} (for legacy chip)	-0.3	7	
	V _{FB} (for new chip)	-0.3	3	
	Voltage range at $\overline{\text{EN}}$ (for legacy chip)	-0.3	13.5	
	Voltage range at $\overline{\text{EN}}$ (for new chip)	-0.3	18	
	PG pin voltage (for legacy chip)	-0.3	16.5	
	PG pin voltage (for new chip)	-0.3	18	
Current	Maximum output current	Internally Limited		A
Temperature	Operating junction (T _J)	-50	150	°C
	Storage (T _{STG})	-65	150	

- (1) Stresses beyond those listed under *Absolute Maximum Rating* may cause permanent damage to the device. These are stress ratings only, which do not imply functional operation of the device at these or any other conditions beyond those indicated under *Recommended Operating Condition*. Exposure to absolute-maximum-rated conditions for extended periods may affect device reliability.
- (2) All voltages with respect to GND.

5.2 ESD Ratings

			VALUE (Legacy Chip)	VALUE (New Chip)	UNIT
V _(ESD)	Electrostatic discharge	Human body model (HBM), per ANSI/ESDA/ JEDEC JS-001, all pins ⁽¹⁾	±2000	±3000	V
		Charged device model (CDM), per JEDEC specification JESD22-C101, all pins ⁽²⁾	N/A	±500	

- (1) JEDEC document JEP155 states that 500V HBM allows safe manufacturing with a standard ESD control process.
- (2) JEDEC document JEP157 states that 250V CDM allows safe manufacturing with a standard ESD control process.

TPS766

SLVS237E – AUGUST 1999 – REVISED MARCH 2024

5.3 Recommended Operating Conditions

over operating free-air temperature range (unless otherwise noted)

		MIN	NOM	MAX	UNIT
V _{IN}	Input voltage (for legacy chip)	2.7		10	V
	Input voltage (for new chip)	2.5		16	
EN	Enable voltage (for legacy chip)	0		16	
	Enable voltage (for new chip)	0		16	
V _{OUT}	Output voltage (for legacy chip)	1.2		5.5	
	Output voltage (for new chip)	1.2		14.6	
I _{OUT}	Output current	0		250	mA
C _{OUT}	Output capacitor (for legacy chip)	4.7			μF
	Output capacitor (for new chip)	1	2.2	220	
C _{OUT} ESR	Output capacitor ESR (for legacy chip)	0.3		10	Ω
	Output capacitor ESR (for new chip)	0		2	
C _{IN}	Input capacitor		1		μF
T _J	Junction temperature	-40		125	°C

5.4 Thermal Information (Legacy Chip)

DISSIPATION RATINGS			
THERMAL METRIC	D (SOIC) 8 PINS		UNIT
	AIR FLOW = 0 CFM	AIR FLOW = 250 CFM	
R _{θJA} (Junction-to-ambient thermal resistance)	176.05	110.62	°C/W
Derating factor above T _A = +25°C	5.68	9.04	mW/°C
Power rating (T _A < 25°C)	568	904	mW
Power rating (T _A = 70°C)	312	497	
Power rating (T _A = 85°C)	227	361	

5.5 Thermal Information (New Chip)

THERMAL METRIC ⁽¹⁾		TPS766 ⁽²⁾	UNIT
		D (SOIC) 8 PINS	
R _{θJA}	Junction-to-ambient thermal resistance	126.5	°C/W
R _{θJC(top)}	Junction-to-case (top) thermal resistance	68.3	°C/W
R _{θJB}	Junction-to-board thermal resistance	75.7	°C/W
Ψ _{JT}	Junction-to-top characterization parameter	18.0	°C/W
Ψ _{JB}	Junction-to-board characterization parameter	74.9	°C/W
R _{θJC(bot)}	Junction-to-case (bottom) thermal resistance	N/A	°C/W

- (1) For more information about traditional and new thermal metrics, see the [Semiconductor and IC Package Thermal Metrics](#) application note.
- (2) Thermal performance results are based on the JEDEC standard of 2s2p PCB configuration. These thermal metric parameters can be further improved by 35-55% based on thermally optimized PCB layout designs. See the analysis of the [Impact of board layout on LDO thermal performance](#) application note.

5.6 Electrical Characteristics

specified at $T_J = -40^\circ\text{C}$ to 125°C , $V_{IN} = V_{OUT(\text{nom})} + 1.0\text{V}$ or $V_{IN} = 2.5\text{V}$ (whichever is greater), $I_{OUT} = 10\mu\text{A}$, $\overline{\text{EN}} = 0\text{V}$, $C_{IN} = 1.0\mu\text{F}$, $C_{OUT} = 4.7\mu\text{F}$ (unless otherwise noted); typical values are at $T_J = 25^\circ\text{C}$

PARAMETER		TEST CONDITIONS	MIN	TYP	MAX	UNIT	
V_{OUT}	Output voltage (10 μA to 250 mA load)	TPS76601 (for legacy chip)	$1.25\text{V} \leq V_{OUT} \leq 5.5\text{V}$, $T_J = +25^\circ\text{C}$		V_{OUT}		
			$1.25\text{V} \leq V_{OUT} \leq 5.5\text{V}$, $T_J = -40^\circ\text{C}$ to 125°C	$0.97 \times V_{OUT}$	$1.03 \times V_{OUT}$		
		TPS76615 (for legacy chip)	$T_J = +25^\circ\text{C}$, $2.7\text{V} < V_{IN} < 10\text{V}$		1.5		V
			$T_J = -40^\circ\text{C}$ to $+125^\circ\text{C}$, $2.7\text{V} < V_{IN} < 10\text{V}$		1.455	1.545	
		TPS76618 (for legacy chip)	$T_J = +25^\circ\text{C}$, $2.8\text{V} < V_{IN} < 10\text{V}$		1.8		
			$T_J = -40^\circ\text{C}$ to $+125^\circ\text{C}$, $2.7\text{V} < V_{IN} < 10\text{V}$		1.746	1.854	
		TPS76625 (for legacy chip)	$T_J = +25^\circ\text{C}$, $3.5\text{V} < V_{IN} < 10\text{V}$		2.5		
			$T_J = -40^\circ\text{C}$ to $+125^\circ\text{C}$, $3.5\text{V} < V_{IN} < 10\text{V}$		2.425	2.575	
		TPS76627 (for legacy chip)	$T_J = +25^\circ\text{C}$, $3.7\text{V} < V_{IN} < 10\text{V}$		2.7		
			$T_J = -40^\circ\text{C}$ to $+125^\circ\text{C}$, $3.7\text{V} < V_{IN} < 10\text{V}$		2.619	2.781	
		TPS76628 (for legacy chip)	$T_J = +25^\circ\text{C}$, $3.8\text{V} < V_{IN} < 10\text{V}$		2.8		
			$T_J = -40^\circ\text{C}$ to $+125^\circ\text{C}$, $3.8\text{V} < V_{IN} < 10\text{V}$		2.716	2.884	
		TPS76630 (for legacy chip)	$T_J = +25^\circ\text{C}$, $4.0\text{V} < V_{IN} < 10\text{V}$		3.0		
			$T_J = -40^\circ\text{C}$ to $+125^\circ\text{C}$, $4.0\text{V} < V_{IN} < 10\text{V}$		2.910	3.090	
		TPS76633 (for legacy chip)	$T_J = +25^\circ\text{C}$, $4.3\text{V} < V_{IN} < 10\text{V}$		3.3		
			$T_J = -40^\circ\text{C}$ to $+125^\circ\text{C}$, $4.3\text{V} < V_{IN} < 10\text{V}$		3.201	3.399	
TPS76650 (for legacy chip)	$T_J = +25^\circ\text{C}$, $6.0\text{V} < V_{IN} < 10\text{V}$		5.0				
	$T_J = -40^\circ\text{C}$ to $+125^\circ\text{C}$, $6.0\text{V} < V_{IN} < 10\text{V}$		4.850	5.150			
TPS766xx (for new chip), $V_{OUT} = 1.8\text{V}$	$T_J = -40^\circ\text{C}$ to 125°C , $V_{OUT} + 1\text{V} \leq V_{IN} \leq 16\text{V}$		0.9785	1.01	$\times V_{OUT}$		
	TPS766xx (for new chip), $V_{OUT} \geq 3.3\text{V}$	$T_J = -40^\circ\text{C}$ to 125°C , $V_{OUT} + 1\text{V} \leq V_{IN} \leq 16\text{V}$		0.982	1.009	$\times V_{OUT}$	
V_{FB}		Feedback voltage	TPS76601 (for legacy chip)	1.25		V	
	TPS76601 (for new chip)		0.8				
I_Q	Quiescent current (GND current), $\overline{\text{EN}} = 0\text{V}$	For legacy chip	$10\mu\text{A} < I_{OUT} < 250\text{mA}$, $T_J = +25^\circ\text{C}$		35	μA	
			$I_{OUT} = 250\text{mA}$, $T_J = -40^\circ\text{C}$ to 125°C		50		
		For new chip	$I_{OUT} = 0\text{mA}$ (for adjustable only)		50		80
			$I_{OUT} = 0\text{mA}$ (for fixed only)		55		90
$\Delta V_{OUT(\Delta V_{OUT})}$	Output voltage line regulation ($\Delta V_{OUT}/V_{OUT}$)	For legacy chip	$V_{OUT(\text{NOM})} + 1.0\text{V} \leq V_{IN} \leq 10\text{V}$, $I_{OUT} = 10\mu\text{A}$		0.01	%V	
		For new chip	$V_{OUT(\text{NOM})} + 1.0\text{V} \leq V_{IN} \leq 16\text{V}$, $I_{OUT} = 10\mu\text{A}$		0.005		

TPS766

SLVS237E – AUGUST 1999 – REVISED MARCH 2024

5.6 Electrical Characteristics (continued)

specified at $T_J = -40^\circ\text{C}$ to 125°C , $V_{IN} = V_{OUT(nom)} + 1.0\text{V}$ or $V_{IN} = 2.5\text{V}$ (whichever is greater), $I_{OUT} = 10\mu\text{A}$, $\overline{\text{EN}} = 0\text{V}$, $C_{IN} = 1.0\mu\text{F}$, $C_{OUT} = 4.7\mu\text{F}$ (unless otherwise noted); typical values are at $T_J = 25^\circ\text{C}$

PARAMETER		TEST CONDITIONS		MIN	TYP	MAX	UNIT
$\Delta V_{OUT(\Delta I_{OUT})}$	Output voltage load regulation	For legacy chip	$10\mu\text{A} \leq I_{OUT} \leq 250\text{mA}$		0.5		%
		For new chip	$10\mu\text{A} \leq I_{OUT} \leq 250\text{mA}$		0.55	1.6	
			$10\mu\text{A} \leq I_{OUT} \leq 250\text{mA}$		20	35	mV
V_n	Output noise voltage	For legacy chip	$\text{BW} = 300\text{Hz to } 50\text{kHz}$, $V_{OUT} = 3.3\text{V}$, $C_{OUT} = 4.7\mu\text{F}$		200		μV_{RMS}
		For new chip	$\text{BW} = 300\text{Hz to } 50\text{kHz}$, $V_{OUT} = 3.3\text{V}$, $I_{OUT} = 100\text{mA}$, $C_{OUT} = 4.7\mu\text{F}$		165		
			$\text{BW} = 10\text{Hz to } 100\text{kHz}$, $V_{OUT} = 3.3\text{V}$, $I_{OUT} = 100\text{mA}$, $C_{OUT} = 4.7\mu\text{F}$		195		
$T_{SD(\text{shutdown})}$	Thermal shutdown junction temperature	For legacy chip			150		$^\circ\text{C}$
	Thermal shutdown temperature	For new chip	Temperature increasing		173		
$T_{SD(\text{reset})}$	Thermal shutdown reset temperature		Temperature falling		157		
I_{CL}	Output current limit	For legacy chip	$V_{OUT} = 0\text{V}$		0.8	1.2	A
		For new chip			0.725	0.8	
I_{STANDBY}	Standby current	For legacy chip	$\overline{\text{EN}} = V_{IN}$, $2.7\text{V} < V_{IN} < 10\text{V}$		1		μA
			$\overline{\text{EN}} = V_{IN}$, $2.7\text{V} < V_{IN} < 10\text{V}$ & $T_J = -40^\circ\text{C}$ to 125°C		10		
		For new chip	$\overline{\text{EN}} = V_{IN}$, $2.5\text{V} < V_{IN} < 16\text{V}$		0.9		
			$\overline{\text{EN}} = V_{IN}$, $2.5\text{V} < V_{IN} < 16\text{V}$ & $T_J = -40^\circ\text{C}$ to 125°C		6.75		
I_{FB}	Feedback pin current	For legacy chip	$V_{\text{FB}} = 1.5\text{V}$		2		nA
		For newchip			10	50	nA
EN	High level enable input voltage	For legacy chip			2		V
	Low level enable input voltage					0.8	
	High level enable input voltage	For new chip	$2.5\text{V} \leq V_{IN} \leq 16\text{V}$		1.2		
	Low level enable input voltage					0.4	
PSRR	Power-supply ripple rejection	For legacy chip	$V_{OUT} = 3.3\text{V}$, $I_{OUT} = 10\mu\text{A}$, $f = 1\text{kHz}$, $T_J = 25^\circ\text{C}$		63		dB
		For new chip	$V_{OUT} = 3.3\text{V}$, $I_{OUT} = 250\text{mA}$, $f = 1\text{kHz}$, $T_J = 25^\circ\text{C}$		58		
PG	Minimum input voltage for valid PG	For legacy chip	$I_{O(\text{PG})} = 300\mu\text{A}$		1.1		$\%V_O$
	Trip threshold voltage (PG_{TH})		V_{OUT} decreasing		92	98	
	Hysteresis voltage ($\text{PG}_{\text{Hysteresis}}$)		Measured at V_{OUT}		0.5		
	Output low voltage		$V_{IN} = 2.7\text{V}$, $I_{O(\text{PG})} = 1\text{mA}$		0.15	0.4	
	Leakage current		$V_{(\text{PG})} = 5\text{V}$			1	
	Minimum input voltage for valid PG	For new chip	$I_{O(\text{PG})} = 300\mu\text{A}$		1.0		$\%V_O$
	Trip threshold voltage (PG_{TH})		V_{OUT} decreasing		91	98.5	
	Hysteresis voltage ($\text{PG}_{\text{Hysteresis}}$)		Measured at V_{OUT}		0.45		
	Output low voltage		$V_{IN} = 2.7\text{V}$, $I_{O(\text{PG})} = 1\text{mA}$		0.12	0.3	
	Leakage current		$V_{(\text{PG})} = 5\text{V}$			2.1	

5.6 Electrical Characteristics (continued)

specified at $T_J = -40^\circ\text{C}$ to 125°C , $V_{IN} = V_{OUT(nom)} + 1.0\text{V}$ or $V_{IN} = 2.5\text{V}$ (whichever is greater), $I_{OUT} = 10\mu\text{A}$, $\overline{\text{EN}} = 0\text{V}$, $C_{IN} = 1.0\mu\text{F}$, $C_{OUT} = 4.7\mu\text{F}$ (unless otherwise noted); typical values are at $T_J = 25^\circ\text{C}$

PARAMETER		TEST CONDITIONS		MIN	TYP	MAX	UNIT
I_{EN}	Input current ($\overline{\text{EN}}$)	For legacy chip	$\overline{\text{EN}} = 0\text{V}$	-1	0	1	μA
			$\overline{\text{EN}} = V_{IN}$	-1	0	1	
		For new chip	$\overline{\text{EN}} = 0\text{V}$	-1	-0.5	1	
			$\overline{\text{EN}} = V_{IN}$	-0.6	0.025	0.4	
V_{DO}	Dropout voltage	TPS76628 (for legacy chip)	$I_{OUT} = 250\text{ mA}$	310			mV
			$I_{OUT} = 250\text{ mA}$, $T_J = -40^\circ\text{C}$ to 125°C	540			
		TPS76628 (for new chip)	$I_{OUT} = 250\text{ mA}$	310			
			$I_{OUT} = 250\text{ mA}$, $T_J = -40^\circ\text{C}$ to 125°C	540			
		TPS76630 (for legacy chip)	$I_{OUT} = 250\text{ mA}$	270			
			$I_{OUT} = 250\text{ mA}$, $T_J = -40^\circ\text{C}$ to 125°C	470			
		TPS76630 (for new chip)	$I_{OUT} = 250\text{ mA}$	270			
			$I_{OUT} = 250\text{ mA}$, $T_J = -40^\circ\text{C}$ to 125°C	470			
		TPS76633 (for legacy chip)	$I_{OUT} = 250\text{ mA}$	230			
			$I_{OUT} = 250\text{ mA}$, $T_J = -40^\circ\text{C}$ to 125°C	400			
		TPS76633 (for new chip)	$I_{OUT} = 250\text{ mA}$	260			
			$I_{OUT} = 250\text{ mA}$, $T_J = -40^\circ\text{C}$ to 125°C	400			
TPS76650 (for legacy chip)	$I_{OUT} = 250\text{ mA}$	140					
	$I_{OUT} = 250\text{ mA}$, $T_J = -40^\circ\text{C}$ to 125°C	250					
TPS76650 (for new chip)	$I_{OUT} = 250\text{ mA}$	250					
	$I_{OUT} = 250\text{ mA}$, $T_J = -40^\circ\text{C}$ to 125°C	390					
$R_{PULLDOWN}$	Output pull-down resistance	TPS766xx (for new chip)	$\overline{\text{EN}} = V_{IN} = 16\text{ V}$, $V_{OUT} = 2.5\text{ V}$	1.8		$\text{K}\Omega$	
t_{STR}	Start-up time	TPS766xx (for new chip)	$T_J = 25^\circ\text{C}$	750		μs	

5.7 Timing Diagram

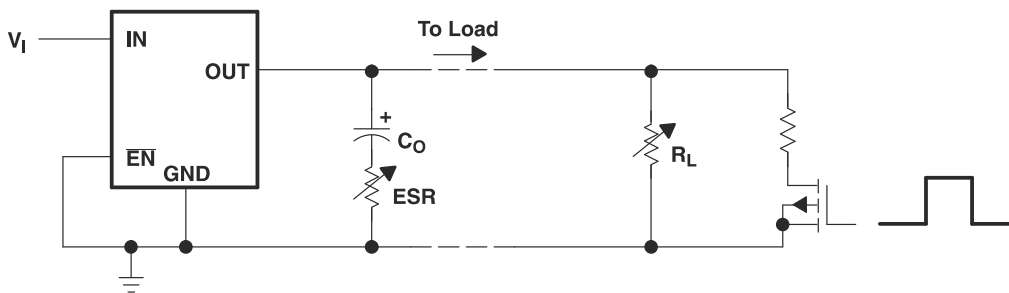

Figure 5-1. Test Circuit for Typical Regions of Stability
(See the [Typical Characteristics: Supported ESR Range](#) section)

TPS766

SLVS237E – AUGUST 1999 – REVISED MARCH 2024

5.8 Typical Characteristics

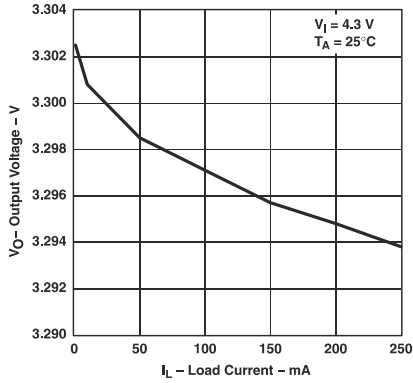

Figure 5-2. TPS76633 Output Voltage vs Load Current (Legacy Chip)

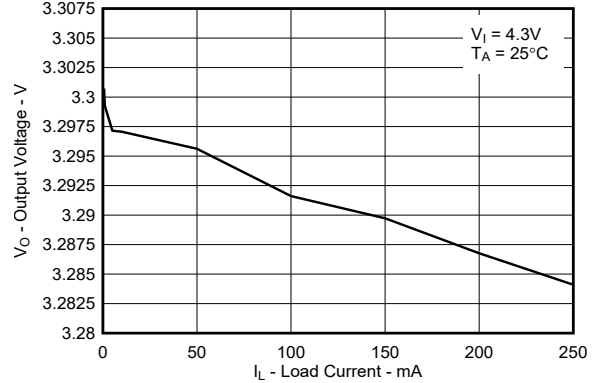

Figure 5-3. TPS76633 Output Voltage vs Load Current (New Chip)

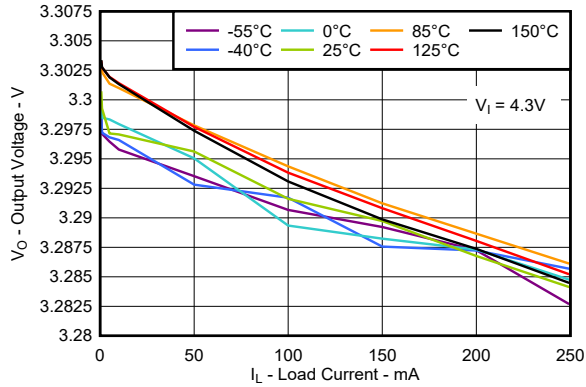

Figure 5-4. TPS76633 Output Voltage vs Load Current (New Chip)

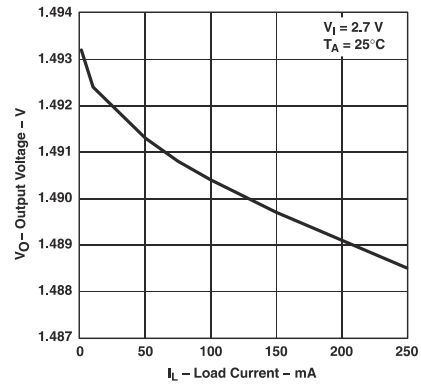

Figure 5-5. TPS76615 Output Voltage vs Load Current (Legacy Chip)

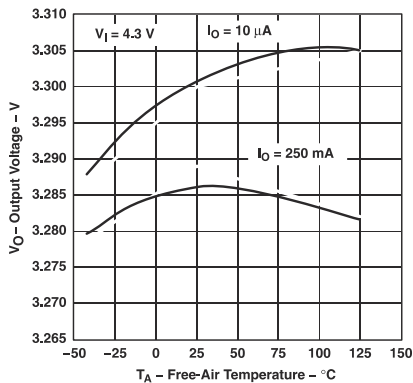

Figure 5-6. TPS76633 Output Voltage vs Free-Air Temperature (Legacy Chip)

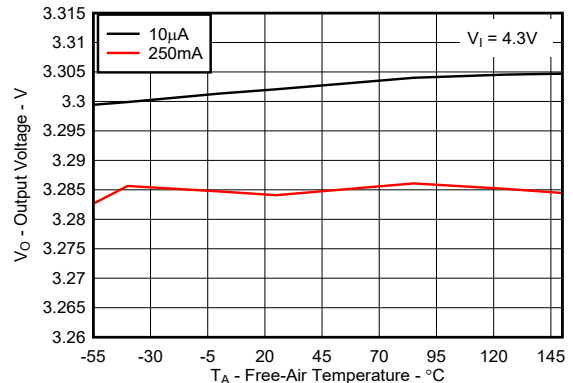

Figure 5-7. TPS76633 Output Voltage vs Free-Air Temperature (New Chip)

5.8 Typical Characteristics (continued)

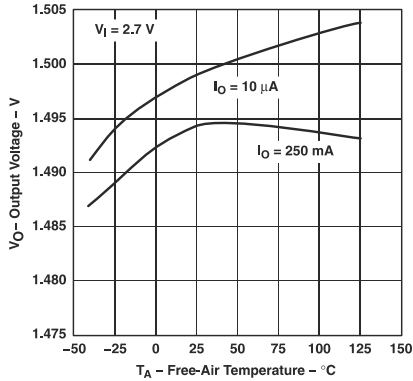

Figure 5-8. TPS76615 Output Voltage vs Free-Air Temperature (Legacy Chip)

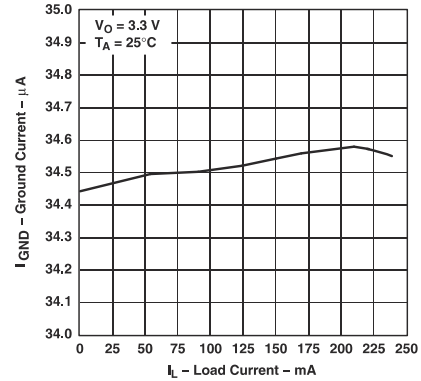

Figure 5-9. TPS76633 Ground Current vs Load Current (Legacy Chip)

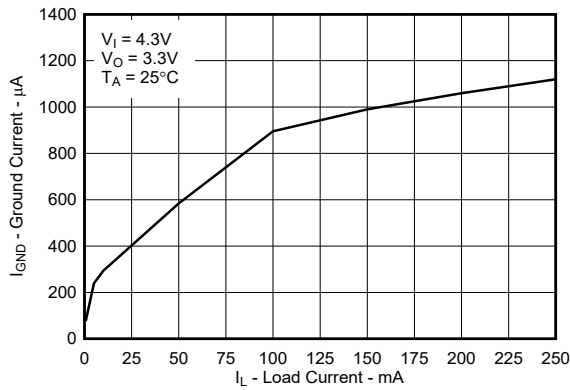

Figure 5-10. TPS76633 Ground Current vs Load Current (New Chip)

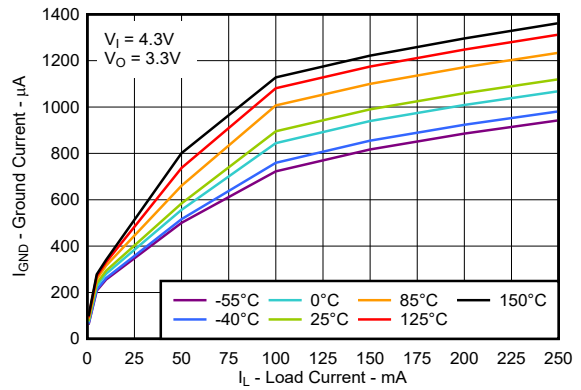

Figure 5-11. TPS76633 Ground Current vs Load Current (New Chip)

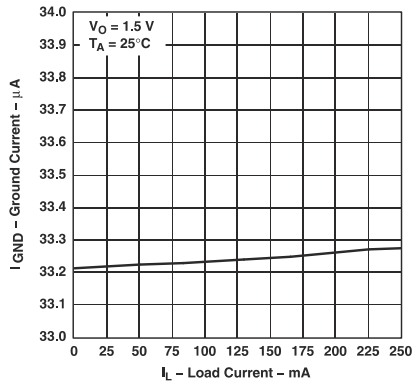

Figure 5-12. TPS76615 Ground Current vs Load Current (Legacy Chip)

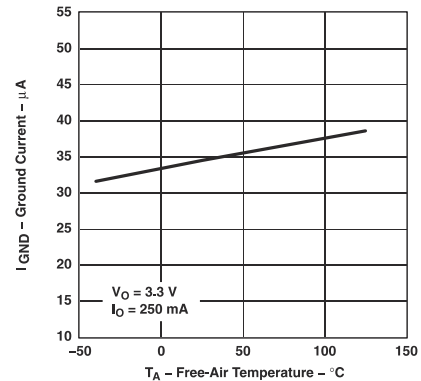

Figure 5-13. TPS76633 Ground Current vs Free-Air Temperature (Legacy Chip)

TPS766

SLVS237E – AUGUST 1999 – REVISED MARCH 2024

5.8 Typical Characteristics (continued)

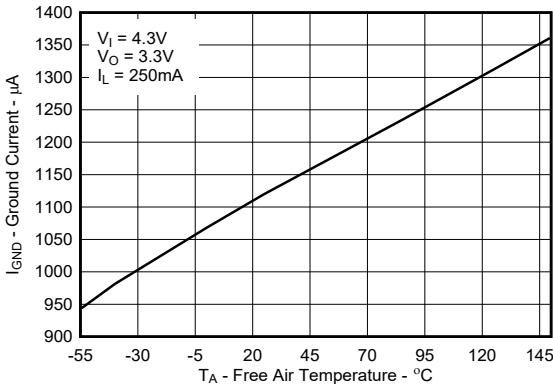

Figure 5-14. TPS76633 Ground Current vs Free-Air Temperature (New Chip)

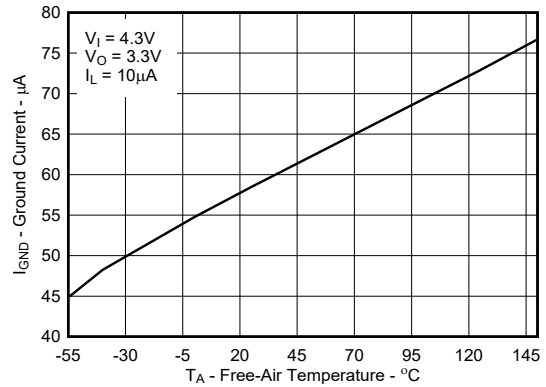

Figure 5-15. TPS76633 Ground Current vs Free-Air Temperature (New Chip)

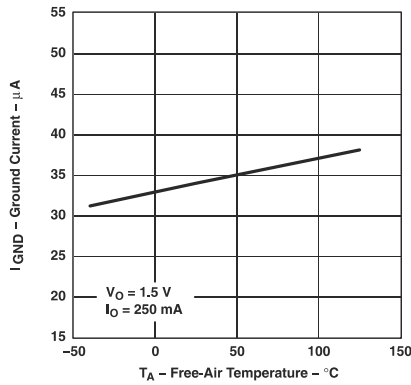

Figure 5-16. TPS76615 Ground Current vs Free-Air Temperature (Legacy Chip)

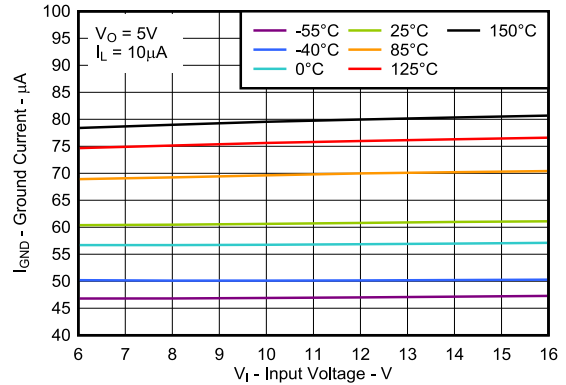

Figure 5-17. TPS76633 Ground Current vs Input Voltage (New Chip)

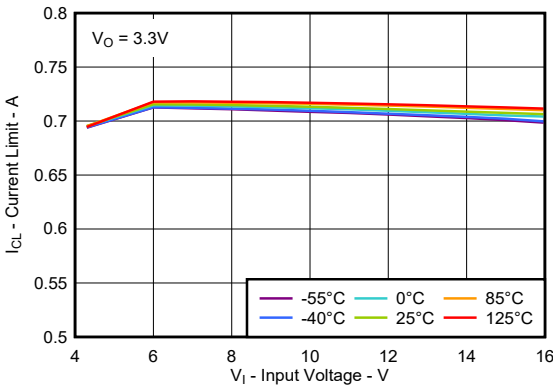

Figure 5-18. TPS76633 Current Limit vs Input Voltage (New Chip)

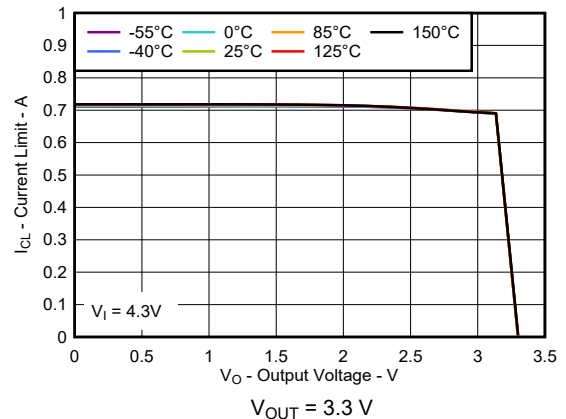

Figure 5-19. TPS76633 Current Limit vs Output Voltage (New Chip)

5.8 Typical Characteristics (continued)

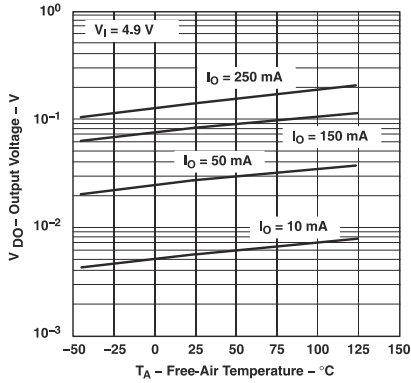

Figure 5-20. TPS76650 Dropout Voltage vs Free-Air Temperature (Legacy Chip)

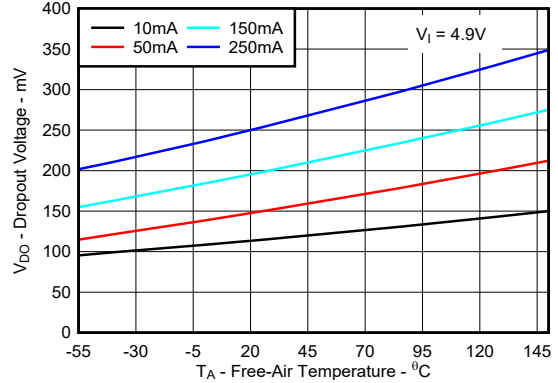

Figure 5-21. TPS76650 Dropout Voltage vs Free-Air Temperature (New Chip)

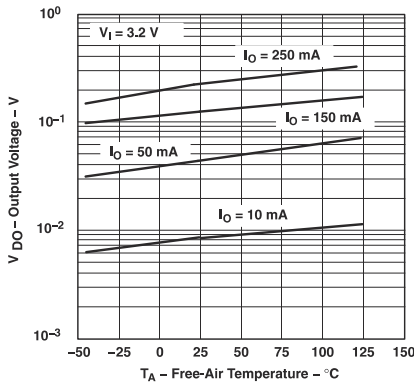

Figure 5-22. TPS76633 Dropout Voltage vs Free-Air Temperature (Legacy Chip)

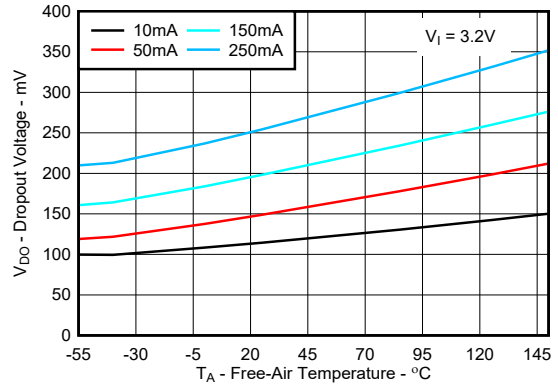

Figure 5-23. TPS76633 Dropout Voltage vs Free-Air Temperature (New Chip)

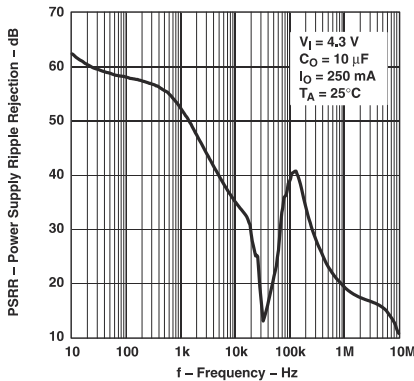

Figure 5-24. TPS76633 Power-Supply Ripple Rejection vs Frequency (Legacy Chip)

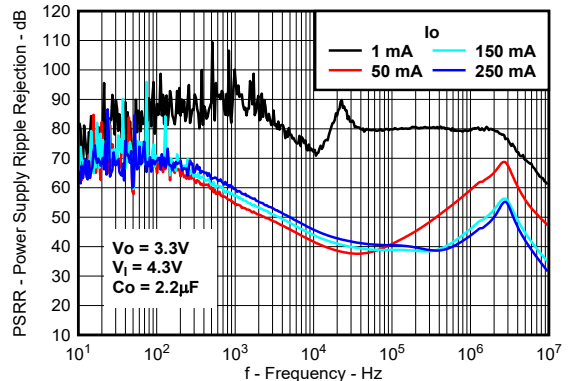

Figure 5-25. TPS76633 Power-Supply Ripple Rejection vs Frequency and Load Current (New Chip)

TPS766

SLVS237E – AUGUST 1999 – REVISED MARCH 2024

5.8 Typical Characteristics (continued)

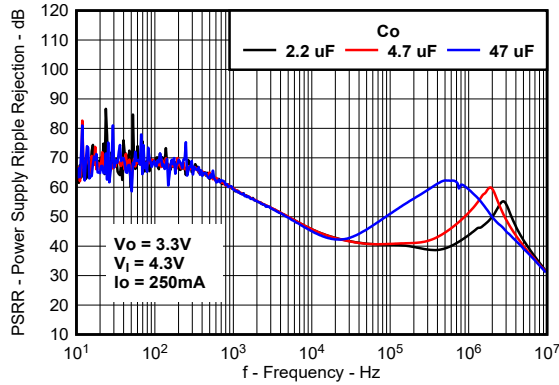

Figure 5-26. TPS76633 Power-Supply Ripple Rejection vs Frequency and Output Capacitor (New Chip)

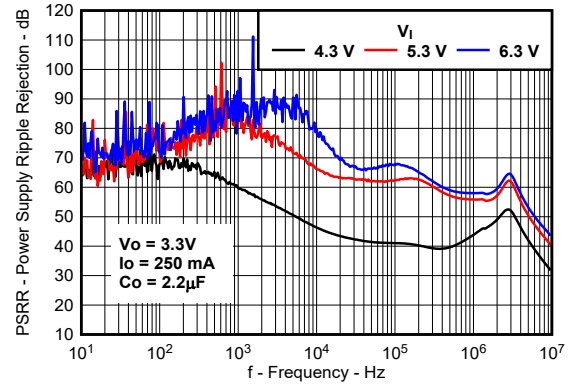

Figure 5-27. TPS76633 Power-Supply Ripple Rejection vs Frequency and Input Voltage (New Chip)

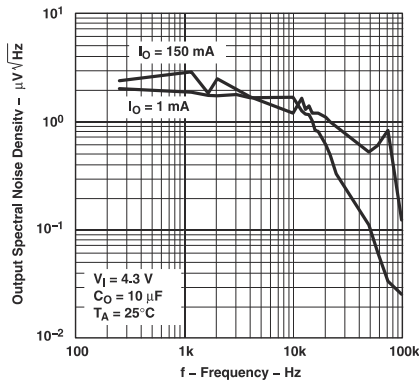

Figure 5-28. TPS76633 Output Spectral Noise Density vs Frequency (Legacy Chip)

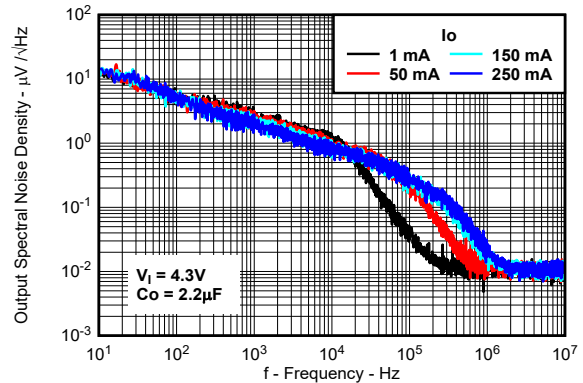

Figure 5-29. TPS76633 Output Spectral Noise Density vs Frequency and Load Current (New Chip)

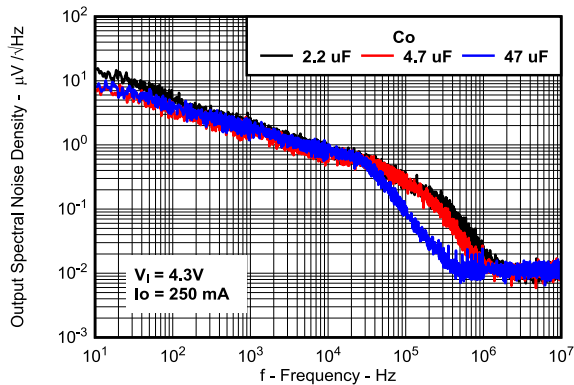

Figure 5-30. TPS76633 Output Spectral Noise Density vs Frequency and Output Capacitor (New Chip)

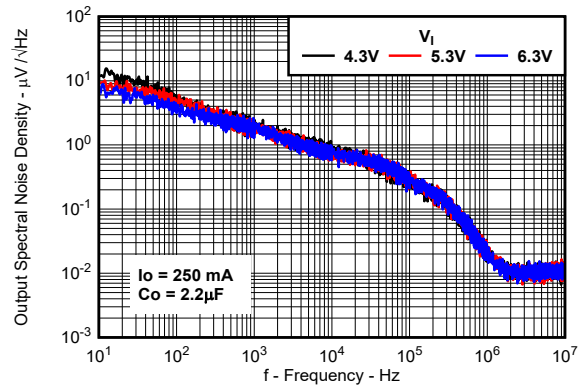

Figure 5-31. TPS76633 Output Spectral Noise Density vs Frequency and Input Voltage (New Chip)

5.8 Typical Characteristics (continued)

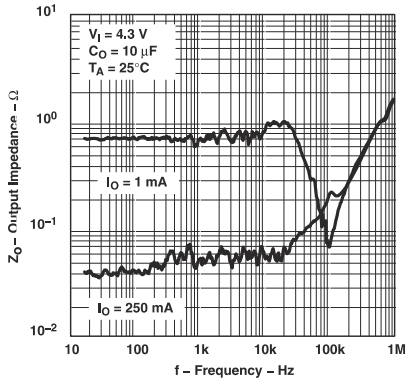

Figure 5-32. TPS76633 Output Impedance vs Frequency (Legacy Chip)

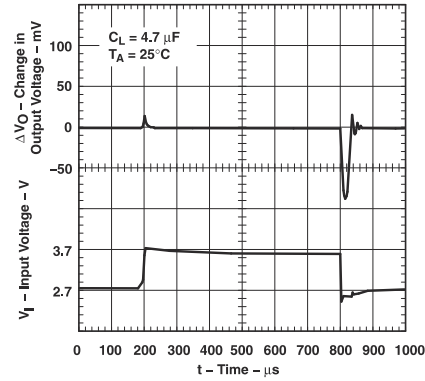

Figure 5-33. TPS76615 Line Transient Response (Legacy Chip)

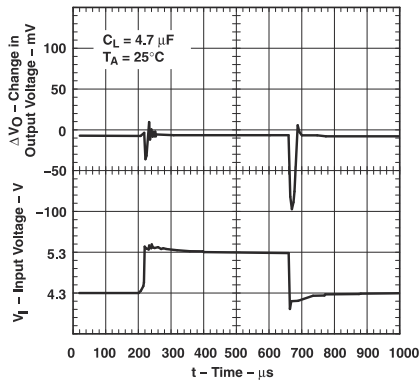

Figure 5-34. TPS76633 Line Transient Response (Legacy Chip)

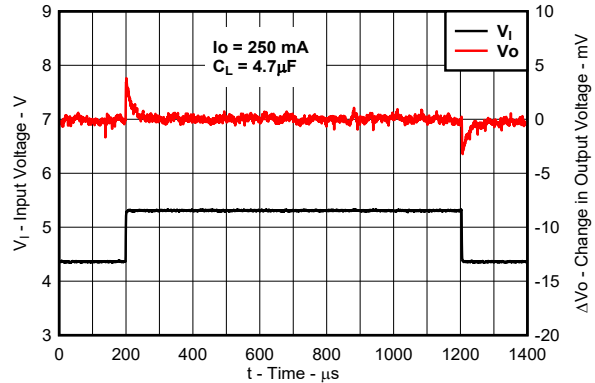

Figure 5-35. TPS76633 Line Transient Response (New Chip)

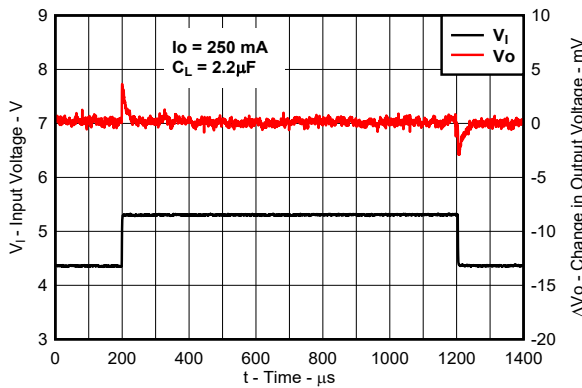

Figure 5-36. TPS76633 Line Transient Response (New Chip)

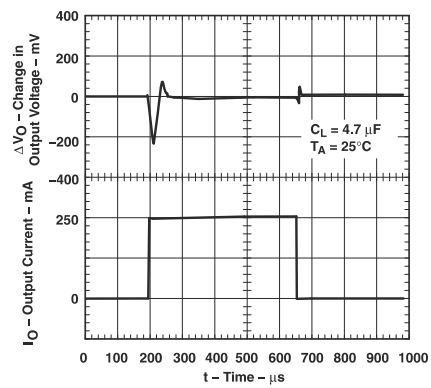

Figure 5-37. TPS76615 Load Transient Response (Legacy Chip)

TPS766

SLVS237E – AUGUST 1999 – REVISED MARCH 2024

5.8 Typical Characteristics (continued)

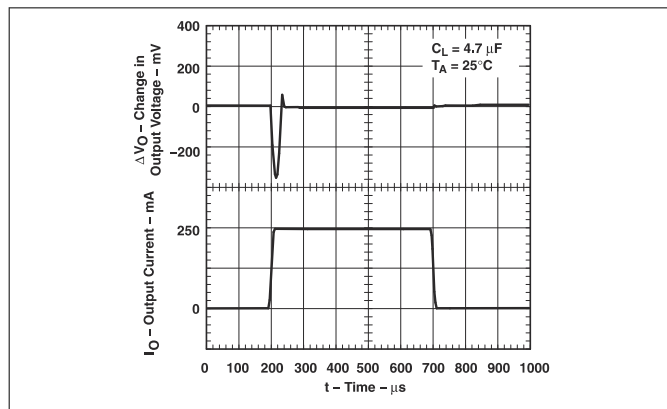

Figure 5-38. TPS76633 Load Transient Response (Legacy Chip)

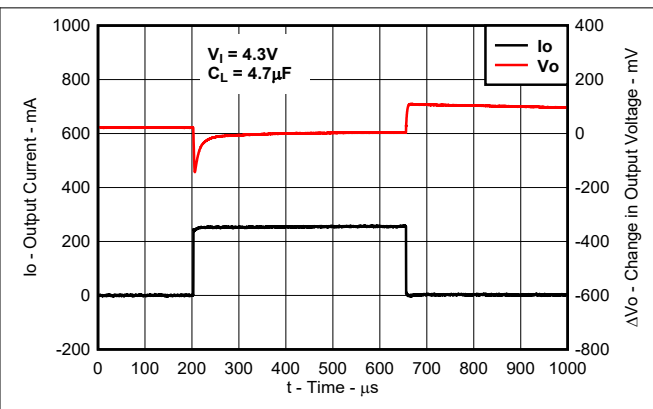

Figure 5-39. TPS76633 Load Transient Response (New Chip)

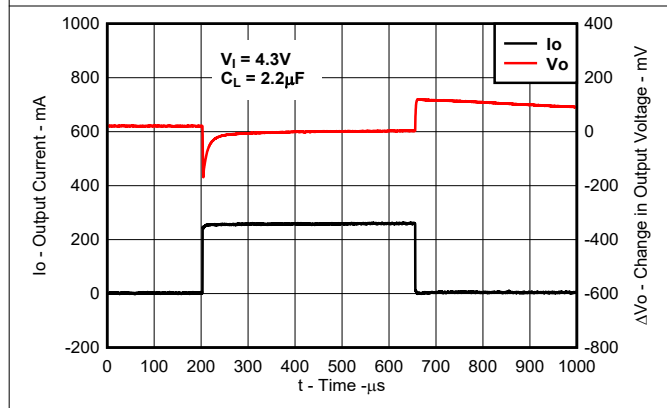

Figure 5-40. TPS76633 Load Transient Response (New Chip)

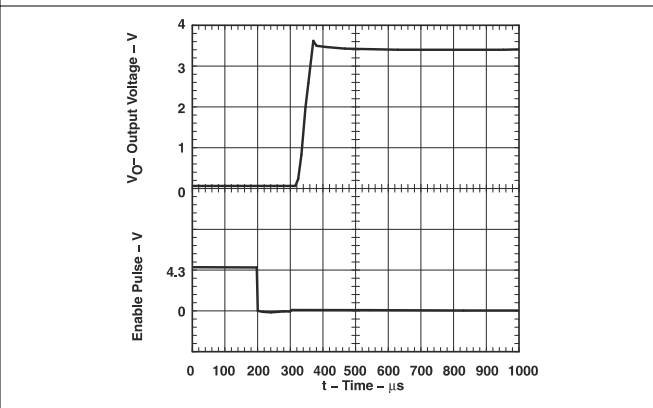

Figure 5-41. TPS76633 Output Voltage vs Time (Legacy Chip)

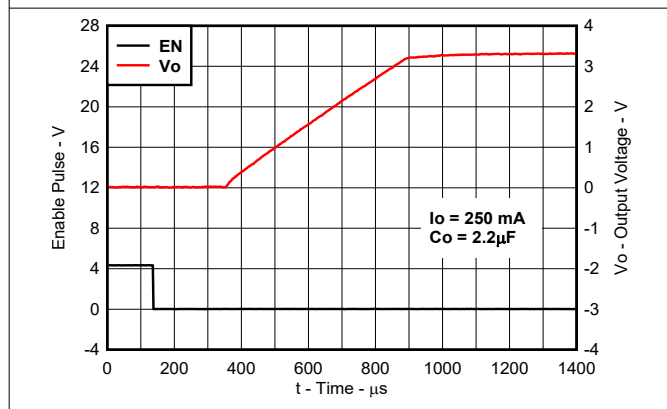

Figure 5-42. TPS76633 Output Voltage vs Time (New Chip)

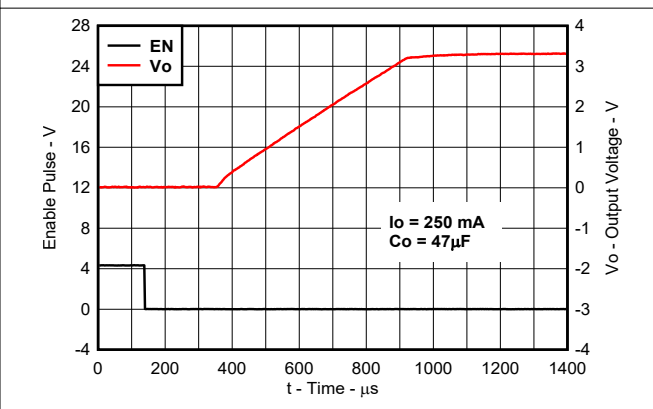

Figure 5-43. TPS76633 Output Voltage vs Time (New Chip)

5.8 Typical Characteristics (continued)

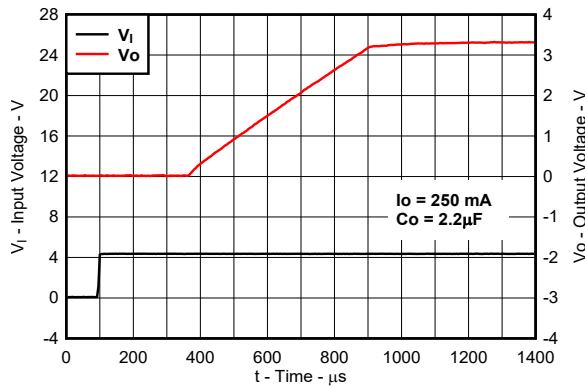

Figure 5-44. TPS76633 Output Voltage vs Time (New Chip)

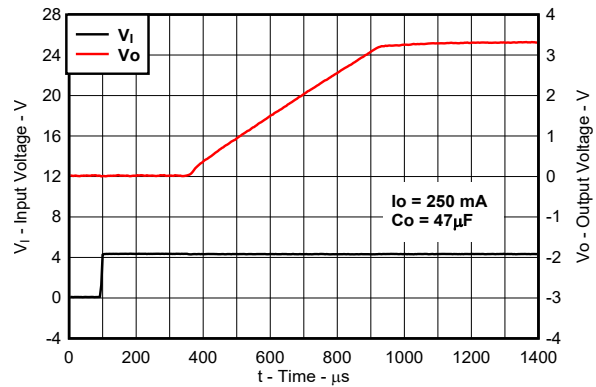

Figure 5-45. TPS76633 Output Voltage vs Time (New Chip)

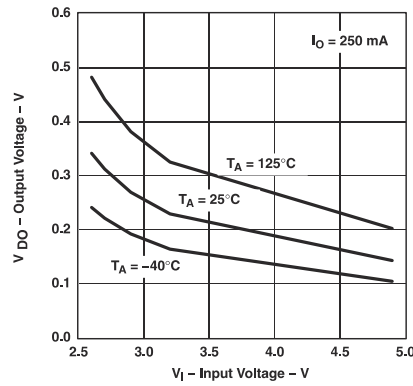

Figure 5-46. TPS76601 Dropout Voltage vs Input Voltage (Legacy Chip)

TPS766

SLVS237E – AUGUST 1999 – REVISED MARCH 2024

5.9 Typical Characteristics: Supported ESR Range

Equivalent series resistance (ESR) refers to the total series resistance, including the ESR of the capacitor, any series resistance added externally, and PCB trace resistance to C_O . The setup shown in the [Timing Diagram](#) section characterizes the ESR behavior across temperature.

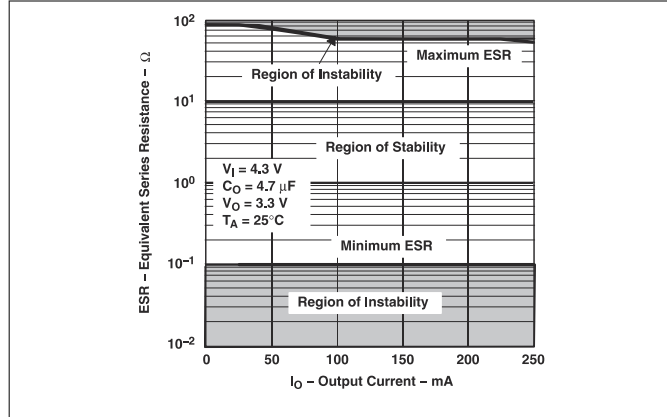

Figure 5-47. Typical Region of Stability ESR vs Output Current (Legacy Chip)

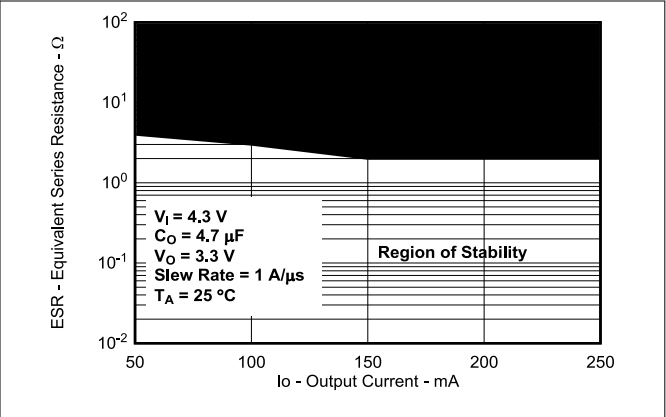

Figure 5-48. Typical Region of Stability ESR vs Output Current (New Chip)

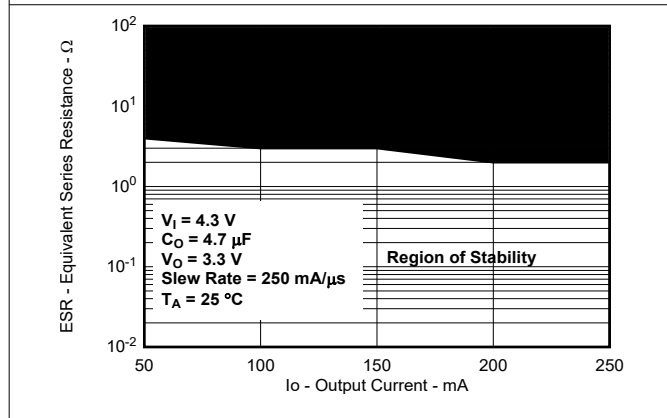

Figure 5-49. Typical Region of Stability ESR vs Output Current (New Chip)

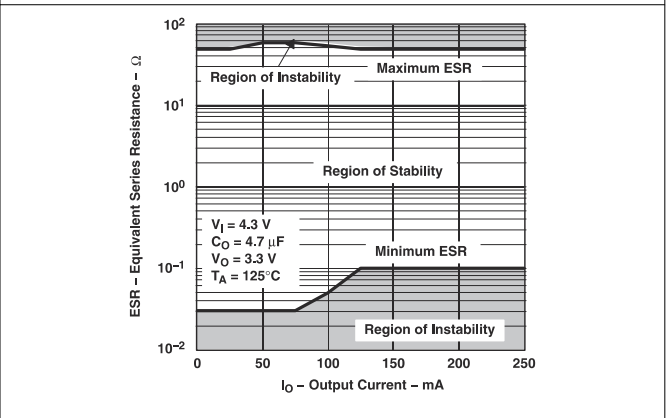

Figure 5-50. Typical Region of Stability ESR vs Output Current (Legacy Chip)

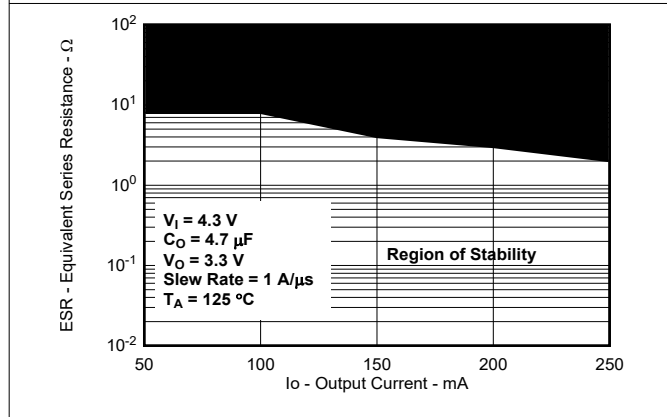

Figure 5-51. Typical Region of Stability ESR vs Output Current (New Chip)

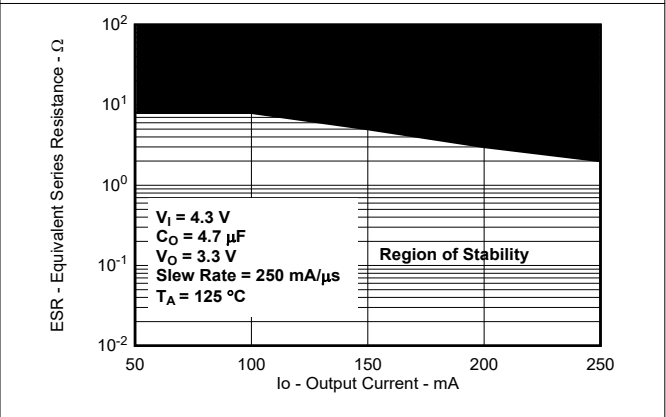

Figure 5-52. Typical Region of Stability ESR vs Output Current (New Chip)

5.9 Typical Characteristics: Supported ESR Range (continued)

Equivalent series resistance (ESR) refers to the total series resistance, including the ESR of the capacitor, any series resistance added externally, and PCB trace resistance to C_O . The setup shown in the [Timing Diagram](#) section characterizes the ESR behavior across temperature.

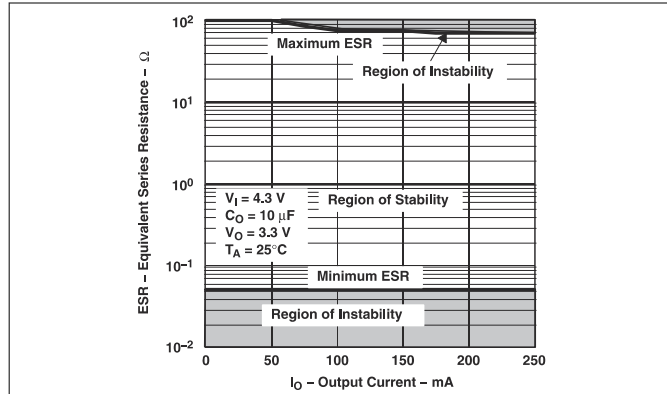

Figure 5-53. Typical Region of Stability ESR vs Output Current (Legacy Chip)

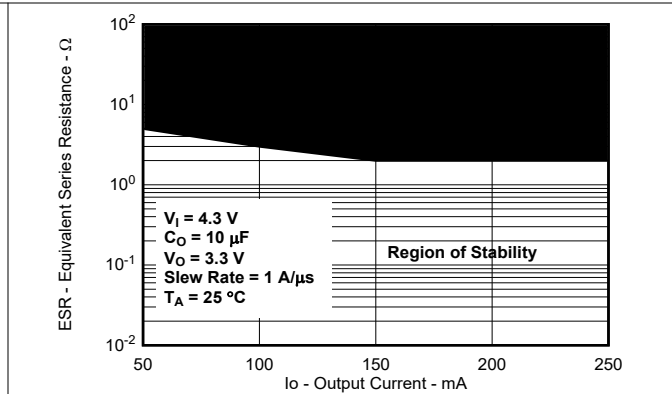

Figure 5-54. Typical Region of Stability ESR vs Output Current (New Chip)

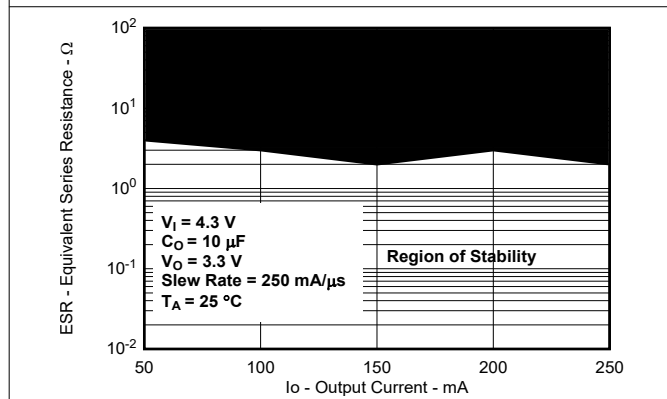

Figure 5-55. Typical Region of Stability ESR vs Output Current (New Chip)

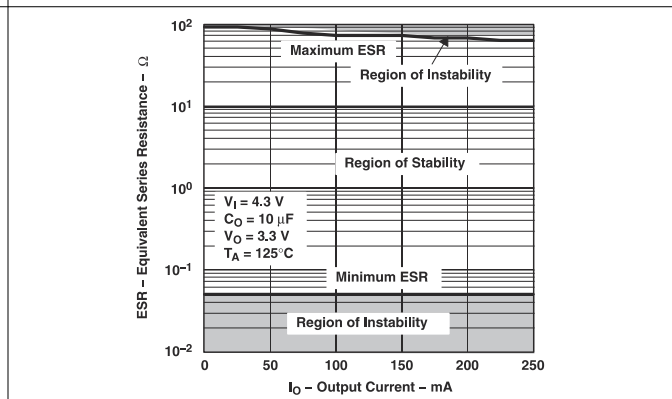

Figure 5-56. Typical Region of Stability ESR vs Output Current (Legacy Chip)

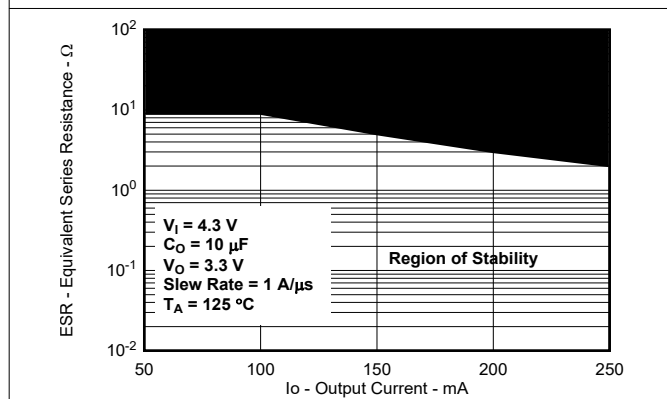

Figure 5-57. Typical Region of Stability ESR vs Output Current (New Chip)

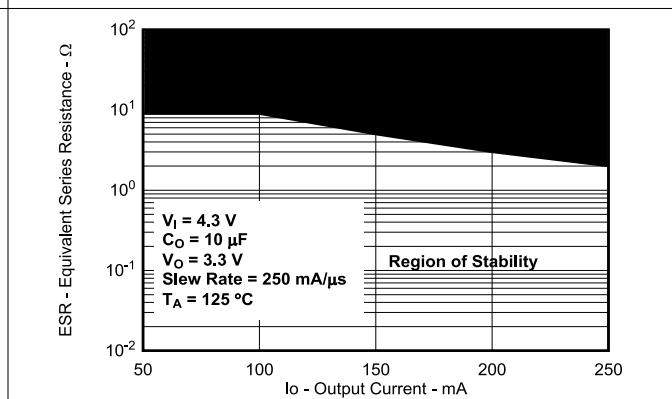

Figure 5-58. Typical Region of Stability ESR vs Output Current (New Chip)

TPS766

SLVS237E – AUGUST 1999 – REVISED MARCH 2024

5.9 Typical Characteristics: Supported ESR Range (continued)

Equivalent series resistance (ESR) refers to the total series resistance, including the ESR of the capacitor, any series resistance added externally, and PCB trace resistance to C_O . The setup shown in the [Timing Diagram](#) section characterizes the ESR behavior across temperature.

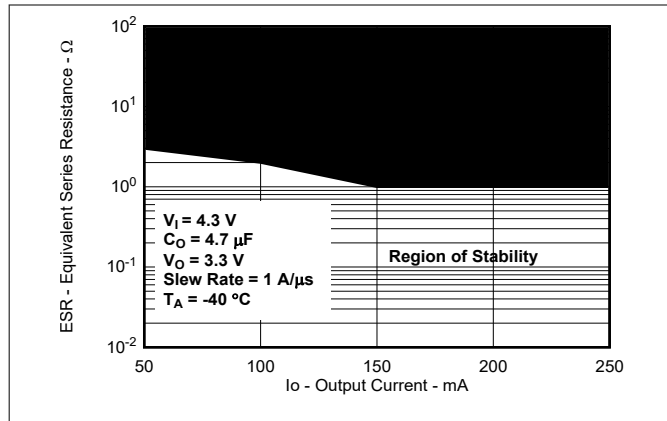

Figure 5-59. Typical Region of Stability ESR vs Output Current (New Chip)

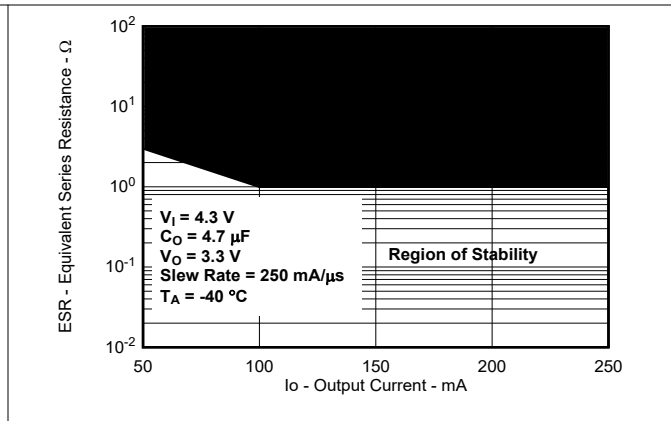

Figure 5-60. Typical Region of Stability ESR vs Output Current (Legacy Chip)

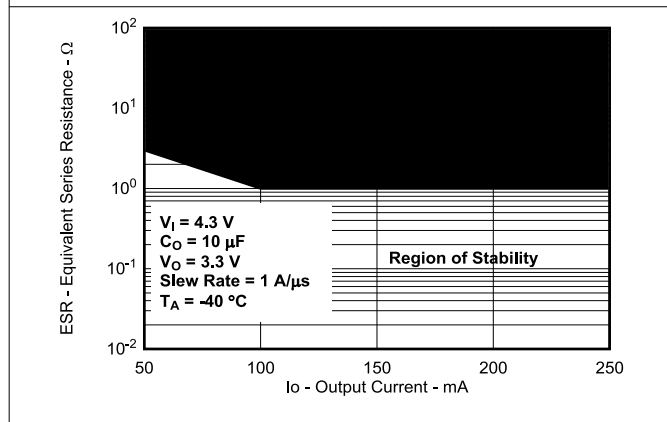

Figure 5-61. Typical Region of Stability ESR vs Output Current (New Chip)

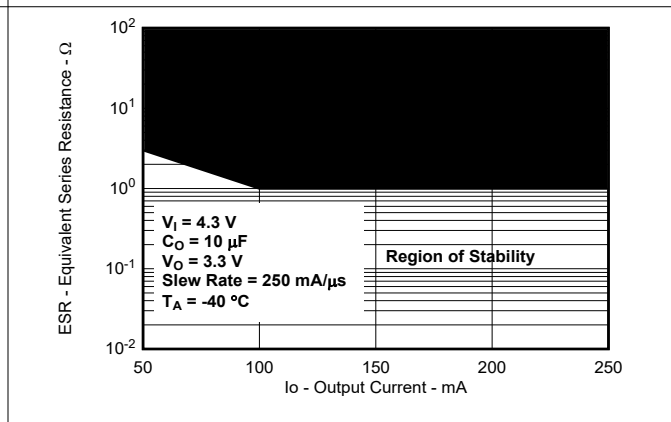

Figure 5-62. Typical Region of Stability ESR vs Output Current (New Chip)

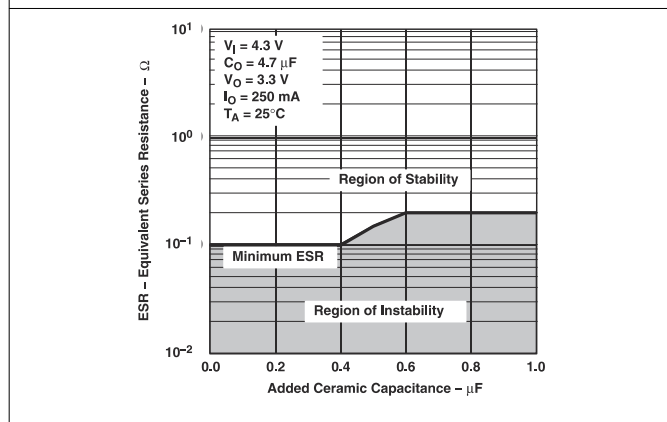

Figure 5-63. Typical Region of Stability ESR vs Added Ceramic Capacitance (Legacy Chip)

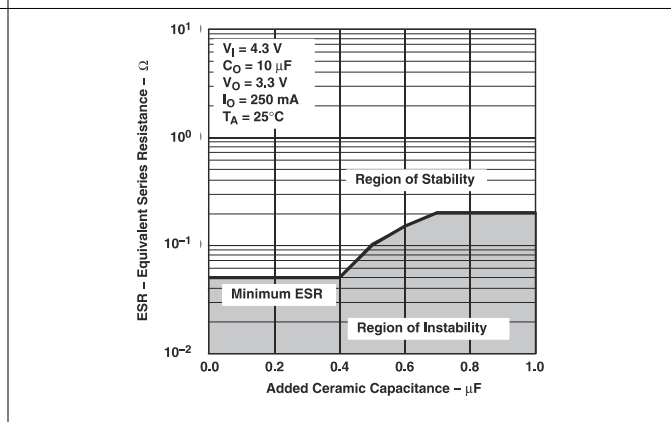

Figure 5-64. Typical Region of Stability ESR vs Added Ceramic Capacitance (Legacy Chip)

6 Detailed Description

6.1 Overview

The TPS766 is a low quiescent current, high PSRR, low-dropout (LDO) voltage regulator capable of handling up to 250mA of the load current. Low quiescent current consumption makes the TPS766 designed for battery-powered applications.

The TPS766 features an integrated overcurrent limit, thermal shutdown, output enable, internal output pulldown, and undervoltage lockout (UVLO). This device delivers excellent line and load transient performance and supports a wide range of ESR (up to 2Ω for the new chip). The operating ambient temperature range of the device is -40°C to $+125^{\circ}\text{C}$.

6.2 Functional Block Diagrams

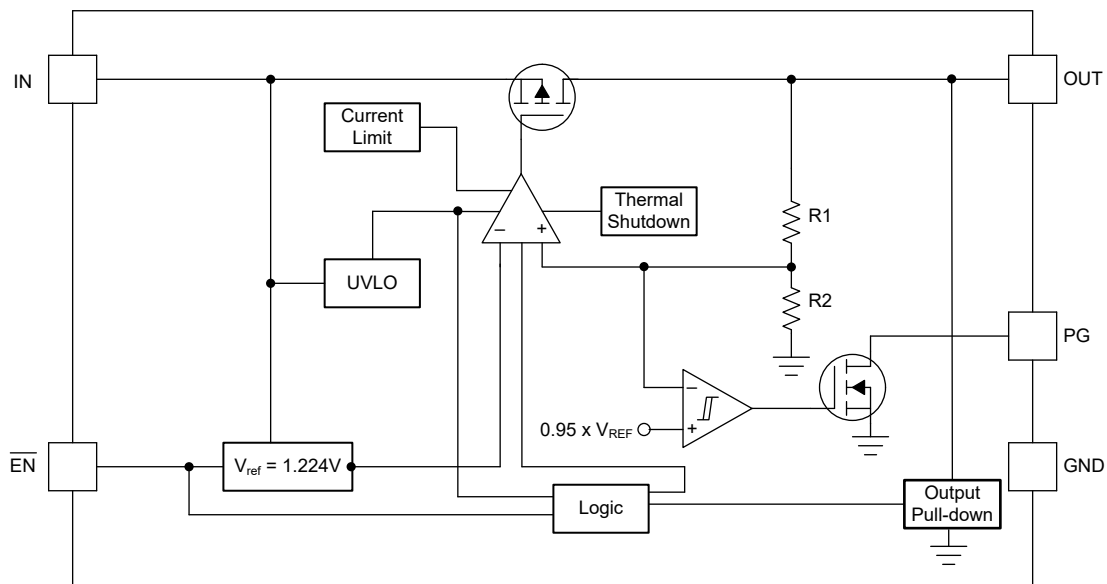

Figure 6-1. Fixed Version

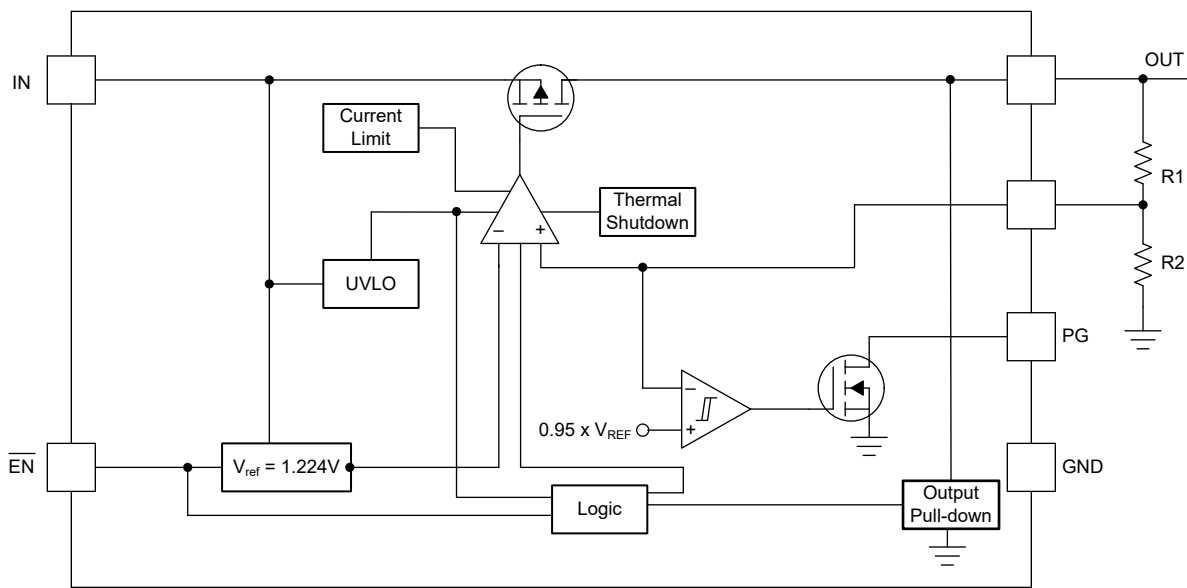

Figure 6-2. Adjustable Version

TPS766

SLVS237E – AUGUST 1999 – REVISED MARCH 2024

6.3 Feature Description**6.3.1 Output Enable**

The enable pin for the device is an active-low pin. The output voltage is enabled when the voltage of the enable pin is lower than the low-level input voltage of the $\overline{\text{EN}}$ pin, and is disabled when the enable pin voltage is higher than the high-level input voltage of the $\overline{\text{EN}}$ pin. If $\overline{\text{EN}}$ functionality is not needed, connect the enable pin to the GND of the device.

For the new chip, there is an internal pullup current on the $\overline{\text{EN}}$ pin. Therefore, leave the $\overline{\text{EN}}$ pin floating. If the $\overline{\text{EN}}$ pin is left floating, the LDO is disabled.

In the new chip, the device has an internal output pulldown circuit that activates when the device is disabled to actively discharge the output voltage; see the [Output Pulldown](#) section.

6.3.2 Dropout Voltage

Dropout voltage (V_{DO}) is defined as the input voltage minus the output voltage ($V_{\text{IN}} - V_{\text{OUT}}$) at the rated output current (I_{RATED}), where the pass transistor is fully on. I_{RATED} is the maximum I_{OUT} listed in the [Recommended Operating Conditions](#) table. The pass transistor is in the ohmic or triode region of operation, and acts as a switch. The dropout voltage indirectly specifies a minimum input voltage greater than the nominal programmed output voltage at which the output voltage is expected to stay in regulation. If the input voltage falls to less than the nominal output regulation, then the output voltage falls as well.

For a CMOS regulator, the dropout voltage is determined by the drain-source on-state resistance ($R_{\text{DS(ON)}}$) of the pass transistor. Therefore, if the linear regulator operates at less than the rated current, the dropout voltage for that current scales accordingly. The following equation calculates the $R_{\text{DS(ON)}}$ of the device.

$$R_{\text{DS(ON)}} = \frac{V_{\text{DO}}}{I_{\text{RATED}}} \quad (1)$$

6.3.3 Current Limit

The device has an internal current limit circuit that protects the regulator during transient high-load current faults or shorting events. The current limit is a brick-wall scheme. In a high-load current fault, the brick-wall scheme limits the output current to the current limit (I_{CL}). I_{CL} is listed in the [Electrical Characteristics](#) table.

The output voltage is not regulated when the device is in current limit. When a current limit event occurs, the device begins to heat up because of the increase in power dissipation. When the device is in brick-wall current limit, the pass transistor dissipates power $[(V_{\text{IN}} - V_{\text{OUT}}) \times I_{\text{CL}}]$. For more information on current limits, see the [Know Your Limits application note](#).

Figure 6-3 shows a diagram of the current limit.

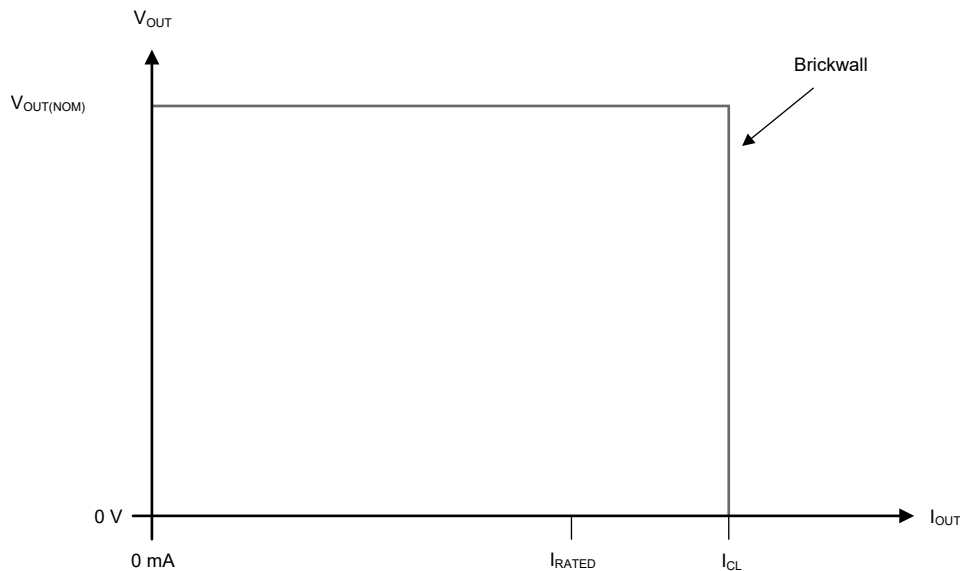

Figure 6-3. Current Limit

6.3.4 Undervoltage Lockout (UVLO)

The device has an independent undervoltage lockout (UVLO) circuit that monitors the input voltage, allowing a controlled and consistent turn on and off of the output voltage. The UVLO circuit has hysteresis functionality to prevent the device from turning off if the input drops during turn on.

6.3.5 Power-Good Function

The power-good circuit monitors the voltage at the output pin to indicate the health of the LDO output. When the output voltage falls below the PG threshold voltage (PG_{TH}), the PG pin open-drain output engages and pulls the PG pin close to GND. When the output voltage exceeds $PG_{TH} + PG_{Hysteresis}$, the PG pin becomes high impedance. The open-drain output requires a pullup resistor. By connecting a pullup resistor to an external supply, any downstream device receives power-good as a logic signal for use in sequencing. Additionally, tie the open-drain output to other open-drain outputs to implement an AND logic. Make sure that the external pullup supply voltage results in a valid logic signal for the receiving device.

When using a feed-forward capacitor (C_{FF}), the time constant for the LDO start-up is increased but the power-good output time constant stays the same, possibly resulting in an invalid status of the power-good output. To avoid this issue, and to receive a valid PG output, make sure that the time constant of both the LDO start-up and the power-good output match. This matching is done by adding a capacitor in parallel with the power-good pullup resistor. For more information, see the [Pros and Cons of Using a Feedforward Capacitor with a Low-Dropout Regulator application note](#).

The state of PG is only valid when the device operates above the minimum input voltage of the device and power-good is asserted, regardless of the output voltage state when the input voltage falls below the UVLO threshold minus the UVLO hysteresis. When the input voltage falls below approximately 0.8V, there is not enough gate drive voltage to keep the open-drain, power-good device turned on and the power-good output pulled high. Connecting the power-good pullup resistor to the output voltage helps minimize this effect.

TPS766

SLVS237E – AUGUST 1999 – REVISED MARCH 2024

6.3.6 Output Pulldown

The device (new chip) has an output pulldown circuit. The output pulldown circuit activates under the following conditions:

- The device is disabled with $\overline{\text{EN}}$ logic
- $1.0\text{V} < V_{\text{IN}} < V_{\text{UVLO}}$

The output pulldown resistance for this device is 1.5k Ω (typ), as listed in the [Electrical Characteristics](#) table.

Reverse current flows from the output to the input. Thus, do not rely on the output pulldown circuit for discharging a large amount of output capacitance after the input supply collapses. This reverse current flow potentially causes damage to the device. See the [Reverse Current](#) section for more details.

6.3.7 Thermal Shutdown

The device contains a thermal shutdown protection circuit to disable the device when the junction temperature (T_{J}) of the pass transistor rises to $T_{\text{SD}(\text{shutdown})}$ (typical). Thermal shutdown hysteresis makes sure that the device resets (turns on) when the temperature falls to $T_{\text{SD}(\text{reset})}$ (typical).

The thermal time constant of the semiconductor die is fairly short, thus the device cycles on and off when thermal shutdown is reached until power dissipation is reduced. Power dissipation during start-up is sometimes high from large $V_{\text{IN}} - V_{\text{OUT}}$ voltage drops across the device or from high inrush currents charging large output capacitors. Under some conditions, the thermal shutdown protection disables the device before start-up completes.

For reliable operation, limit the junction temperature to the maximum listed in the [Recommended Operating Conditions](#) table. Operation above this maximum temperature causes the device to exceed operational specifications. Although the internal protection circuitry of the device is designed to protect against thermal overall conditions, this circuitry is not intended to replace proper heat sinking. Continuously running the device into thermal shutdown or above the maximum recommended junction temperature reduces long-term reliability.

6.4 Device Functional Modes

6.4.1 Device Functional Mode Comparison

Table 6-1 shows the conditions that lead to the different modes of operation. See the [Electrical Characteristics](#) table for parameter values.

Table 6-1. Device Functional Mode Comparison

OPERATING MODE	PARAMETER			
	V_{IN}	V_{EN}	I_{OUT}	T_J
Normal operation	$V_{IN} > V_{OUT(nom)} + V_{DO}$ and $V_{IN} > V_{IN(min)}$	$V_{EN} < V_{EN(LOW)}$	$I_{OUT} < I_{OUT(max)}$	$T_J < T_{SD(shutdown)}$
Dropout operation	$V_{IN(min)} < V_{IN} < V_{OUT(nom)} + V_{DO}$	$V_{EN} < V_{EN(LOW)}$	$I_{OUT} < I_{OUT(max)}$	$T_J < T_{SD(shutdown)}$
Disabled (any true condition disables the device)	$V_{IN} < V_{UVLO}$	$V_{EN} > V_{EN(HI)}$	Not applicable	$T_J > T_{SD(shutdown)}$

6.4.2 Normal Operation

The device regulates to the nominal output voltage when the following conditions are met:

- The input voltage is greater than the nominal output voltage plus the dropout voltage ($V_{OUT(nom)} + V_{DO}$)
- The current sourced from OUT is less than the current limit ($I_{OUT} < I_{CL(OUT)}$)
- The device junction temperature is less than the thermal shutdown temperature ($T_J < T_{SD}$)
- The enable voltage was previously lowered than the enable low level threshold voltage and has not yet increased higher than the enable high level threshold or the \overline{EN} pin is connected to ground

6.4.3 Dropout Operation

If the input voltage is lower than the nominal output voltage plus the specified dropout voltage, but all other conditions are met for normal operation, the device operates in dropout mode. In this mode, the output voltage tracks the input voltage. During this mode, the transient performance of the device becomes significantly degraded because the pass transistor is in the ohmic or triode region, and acts as a switch. Line or load transients in dropout potentially result in large output voltage deviations.

When the device is in a steady dropout state (defined as when the device is in dropout, $V_{IN} < V_{OUT(nom)} + V_{DO}$, directly after being in a normal regulation state, but not during start up), the pass transistor is driven into the ohmic or triode region. When the input voltage returns to a value greater than or equal to the nominal output voltage plus the dropout voltage ($V_{OUT(nom)} + V_{DO}$), the output voltage overshoots for a short period of time while the device pulls the pass transistor back into the linear region.

6.4.4 Disabled

The output of the device is shutdown by forcing the voltage of the enable pin to be more than the minimum EN pin high-level input voltage (see the [Electrical Characteristics](#) table). When disabled, the pass transistor is turned off, internal circuits are shutdown, and the output voltage is actively discharged to ground by an internal discharge circuit from the output to ground.

TPS766

SLVS237E – AUGUST 1999 – REVISED MARCH 2024

7 Application and Implementation

Note

Information in the following applications sections is not part of the TI component specification, and TI does not warrant its accuracy or completeness. TI's customers are responsible for determining suitability of components for their purposes, as well as validating and testing their design implementation to confirm system functionality.

7.1 Application Information

The TPS766 LDO provides a very accurate output with high PSRR and excellent line and load transient performance and is capable of handling up to 250mA of the load current. Low quiescent current consumption makes the TPS766 designed for battery-powered applications. The TPS766 low dropout at a full load of 250mA helps extend the battery operation range.

7.2 Typical Application

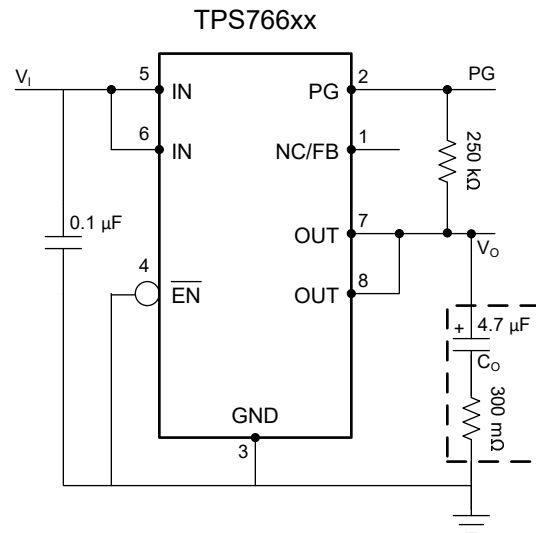
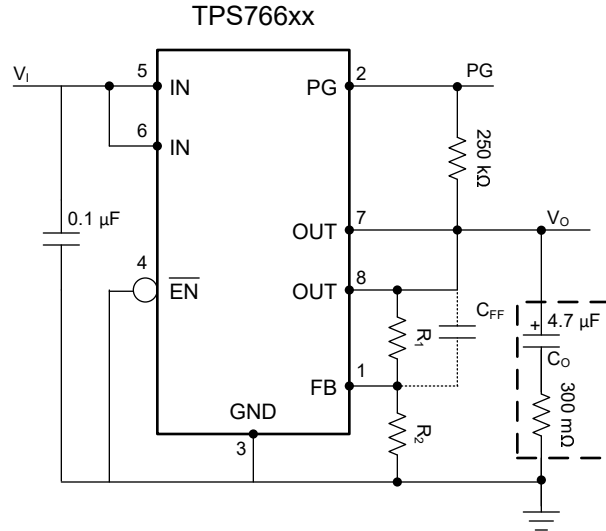

Figure 7-1. Typical Application Circuit (Fixed-Voltage Version)



Dotted lines indicate an optional C_{FF} capacitor (new chip). See the [Feed-Forward Capacitor \(\$C_{FF}\$ \)](#) section.

Figure 7-2. Typical Application Circuit (Adjustable-Voltage Version)

[Table 7-1](#) lists the R_1 and R_2 resistor values for the adjustable-voltage version.

Table 7-1. Adjustable Output Voltage for Resistors R_1 and R_2

OUTPUT VOLTAGE	R_1 (k Ω)	R_2 (k Ω)
2.5V	174	169
3.3V	287	169
3.6V	324	169
4.0V	383	169
5.0V	523	169

7.2.1 Design Requirements

[Table 7-2](#) summarizes the design requirements of [Table 7-1](#).

Table 7-2. Design Parameters

PARAMETER	VALUE
Input voltage (V_{IN})	12V
Output voltage (V_{OUT})	3.3V
Output current (I_L)	100mA
Enable voltage (\overline{EN})	0V
Weak pullup resistor for the PG pin	250k Ω

7.2.2 Detailed Design Procedure

7.2.2.1 Adjustable Device Feedback Resistors

The adjustable-version device requires external feedback divider resistors to set the output voltage. V_{OUT} is set using the feedback divider resistors, R_1 and R_2 , according to the following equation:

$$V_{OUT} = V_{REF} \times (1 + R_1 / R_2) \quad (2)$$

where:

- $V_{REF} = 1.224V$ (typ) for the internal reference voltage

TPS766

SLVS237E – AUGUST 1999 – REVISED MARCH 2024

To ignore the FB pin current error term in the V_{OUT} equation, set the feedback divider current to 100 times the FB pin current listed in the [Electrical Characteristics](#) table. This setting provides the maximum feedback divider series resistance, as shown in the following equation:

$$R_1 + R_2 \leq V_{OUT} / (I_{FB} \times 100) \quad (3)$$

In [Table 7-1](#), examples of R_1 and R_2 values are given for different output voltage options with a feedback divider current designed at $7\mu\text{A}$.

7.2.2.2 Recommended Capacitor Types

The device (new chip) is designed to be stable using low equivalent series resistance (ESR) ceramic capacitors at the input and output. Multilayer ceramic capacitors have become the industry standard for these types of applications and are recommended, but use good judgment. Ceramic capacitors that employ X7R-, X5R-, and C0G-rated dielectric materials provide relatively good capacitive stability across temperature, whereas using Y5V-rated capacitors is discouraged because of large variations in capacitance.

Regardless of the ceramic capacitor type selected, the effective capacitance varies with operating voltage and temperature. Generally, expect the effective capacitance to decrease by as much as 50%. The input and output capacitors discussed in the [Section 5.3](#) table account for an effective capacitance of approximately 50% of the nominal value.

7.2.2.3 Input and Output Capacitor Requirements

Although an input capacitor is not required for stability, good analog design practice is to connect a capacitor from IN to GND. This capacitor counteracts reactive input sources and improves transient response, input ripple, and PSRR. Use an input capacitor if the source impedance is more than 0.5Ω . Use a higher value capacitor if large, fast rise-time load or line transients are anticipated or if the device is located several inches from the input power source.

As with most low-dropout regulators, the TPS766 requires an output capacitor connected between OUT and GND to stabilize the internal control loop.

Legacy chip: The minimum recommended capacitance value is $4.7\mu\text{F}$ and the equivalent series resistance (ESR) is between $300\text{m}\Omega$ and 20Ω . Capacitor values of $4.7\mu\text{F}$ or larger are acceptable, provided the ESR is less than 20Ω . Solid tantalum electrolytic and aluminum electrolytic capacitors are all suitable, provided these capacitors meet the requirements described previously. Ceramic capacitors, with series resistors sized to meet the previously described requirements, are another option.

New chip: The device is designed to be stable using low ESR ceramic capacitors at the input and output. The minimum recommended capacitance value is $2.2\mu\text{F}$ and the ESR range is up to 2Ω . The supported ESR range depends on the output capacitance, operating junction temperature, and load current conditions. The [Typical Characteristics: Supported ESR Range](#) describes the supported ESR range in regards to the output capacitance across temperature for the supported load current range.

Dynamic performance of the device is improved by using an output capacitor. Use an output capacitor within the range specified in the [Section 5.3](#) table for stability.

7.2.2.4 Reverse Current

Excessive reverse current potentially damages this device. Reverse current flows through the intrinsic body diode of the pass transistor instead of the normal conducting channel. At high magnitudes, this current flow degrades the long-term reliability of the device.

Conditions where reverse current occur are outlined in this section, all of which potentially exceed the absolute maximum rating of $V_{OUT} \leq V_{IN} + 0.3\text{V}$.

- If the device has a large C_{OUT} and the input supply collapses with little or no load current
- The output is biased when the input supply is not established
- The output is biased above the input supply

If reverse current flow is expected in the application, external protection is recommended to protect the device. Reverse current is not limited in the device, so external limiting is required if extended reverse voltage operation is anticipated.

Figure 7-3 shows one approach for protecting the device.

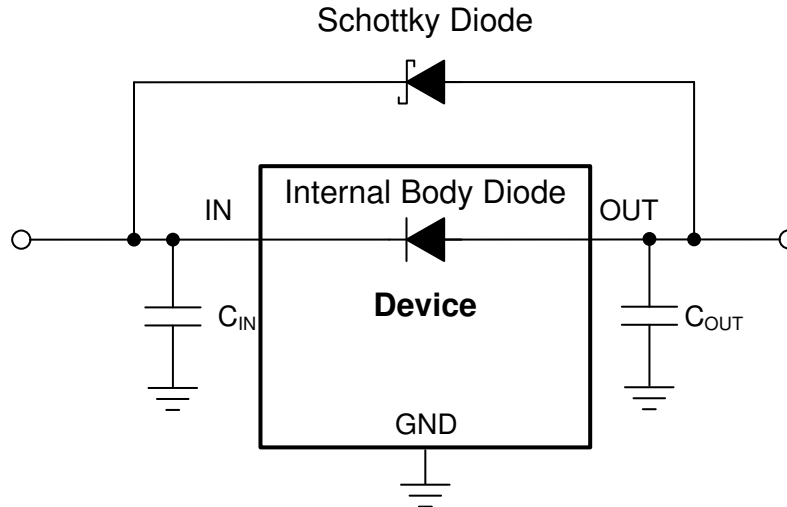

Figure 7-3. Example Circuit for Reverse Current Protection Using a Schottky Diode

7.2.2.5 Feed-Forward Capacitor (C_{FF})

For the adjustable-voltage version device, connect a feed-forward capacitor (C_{FF}) from the OUT pin to the FB pin. C_{FF} improves transient, noise, and PSRR performance, but is not required for regulator stability. Recommended C_{FF} values are listed in the [Recommended Operating Conditions](#) table. If a higher capacitance C_{FF} is used, the start-up time increases. For a detailed description of C_{FF} tradeoffs, see the [Pros and Cons of Using a Feedforward Capacitor with a Low-Dropout Regulator](#) application note.

C_{FF} and R_1 form a zero in the loop gain at frequency f_z , while C_{FF} , R_1 , and R_2 form a pole in the loop gain at frequency f_p . Calculate the C_{FF} zero and pole frequencies from the following equations:

$$f_z = 1 / (2 \times \pi \times C_{FF} \times R_1) \quad (4)$$

$$f_p = 1 / (2 \times \pi \times C_{FF} \times (R_1 \parallel R_2)) \quad (5)$$

$C_{FF} \geq 10\text{pF}$ is required for stability if the feedback divider current is less than $5\mu\text{A}$. The following equation calculates the feedback divider current.

$$I_{\text{FB_Divider}} = V_{\text{OUT}} / (R_1 + R_2) \quad (6)$$

To avoid start-up time increases from C_{FF} , limit the product $C_{FF} \times R_1 < 50\mu\text{s}$.

For an output voltage of 1.224V with the FB pin tied to the OUT pin, no C_{FF} is used.

TPS766

SLVS237E – AUGUST 1999 – REVISED MARCH 2024

7.2.2.6 Power Dissipation (P_D)

Circuit reliability requires consideration of the device power dissipation, location of the circuit on the printed circuit board (PCB), and correct sizing of the thermal plane. Place few or no other heat-generating devices that cause added thermal stress in the PCB area around the regulator.

To first-order approximation, power dissipation in the regulator depends on the input-to-output voltage difference and load conditions. The following equation calculates power dissipation (P_D).

$$P_D = (V_{IN} - V_{OUT}) \times I_{OUT} \quad (7)$$

Note

Minimize power dissipation, and therefore achieve greater efficiency, by correctly selecting the system voltage rails. For the lowest power dissipation use the minimum input voltage required for correct output regulation.

For devices with a thermal pad, the primary heat conduction path for the device package is through the thermal pad to the PCB. Solder the thermal pad to a copper pad area under the device. This pad area contains an array of plated vias that conduct heat to additional copper planes for increased heat dissipation.

The maximum power dissipation determines the maximum allowable ambient temperature (T_A) for the device. According to the following equation, power dissipation and junction temperature are most often related by the junction-to-ambient thermal resistance ($R_{\theta JA}$) of the combined PCB and device package and the temperature of the ambient air (T_A).

$$T_J = T_A + (R_{\theta JA} \times P_D) \quad (8)$$

Thermal resistance ($R_{\theta JA}$) is highly dependent on the heat-spreading capability built into the particular PCB design, and therefore varies according to the total copper area, copper weight, and location of the planes. The junction-to-ambient thermal resistance listed in the [Thermal Information \(New Chip\)](#) table is determined by the JEDEC standard PCB and copper-spreading area, and is used as a relative measure of package thermal performance. As mentioned in the [An empirical analysis of the impact of board layout on LDO thermal performance application note](#), $R_{\theta JA}$ is improved by 35% to 55% compared to the [Thermal Information \(New Chip\)](#) table value by optimizing the PCB board layout.

7.2.2.7 Estimating Junction Temperature

The JEDEC standard now recommends the use of psi (Ψ) thermal metrics to estimate the junction temperatures of the linear regulator when in-circuit on a typical PCB board application. These metrics are not thermal resistance parameters and instead offer a practical and relative way to estimate junction temperature. These psi metrics are determined to be significantly independent of the copper area available for heat-spreading. The [Thermal Information \(New Chip\)](#) table lists the primary thermal metrics, which are the junction-to-top characterization parameter (ψ_{JT}) and junction-to-board characterization parameter (ψ_{JB}). These parameters provide two methods for calculating the junction temperature (T_J), as described in the following equations. Use the junction-to-top characterization parameter (ψ_{JT}) with the temperature at the center-top of device package (T_T) to calculate the junction temperature. Use the junction-to-board characterization parameter (ψ_{JB}) with the PCB surface temperature 1 mm from the device package (T_B) to calculate the junction temperature.

$$T_J = T_T + \psi_{JT} \times P_D \quad (9)$$

where:

- P_D is the dissipated power
- T_T is the temperature at the center-top of the device package

$$T_J = T_B + \psi_{JB} \times P_D \quad (10)$$

where:

- T_B is the PCB surface temperature measured 1mm from the device package and centered on the package edge

For detailed information on the thermal metrics and how to use them, see the [Semiconductor and IC Package Thermal Metrics](#) application note.

7.2.3 Application Curves

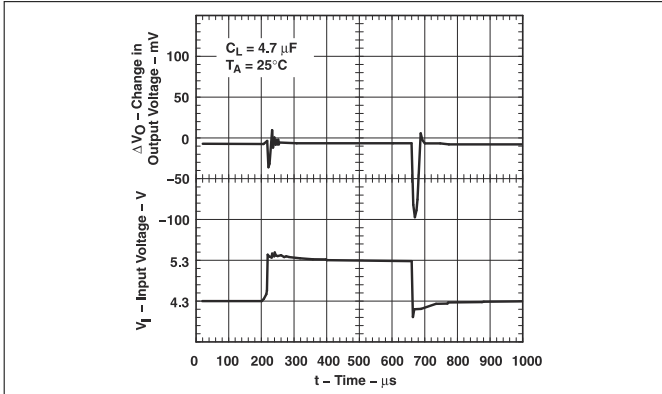

Figure 7-4. TPS76633 Line Transient Response (Legacy Chip)

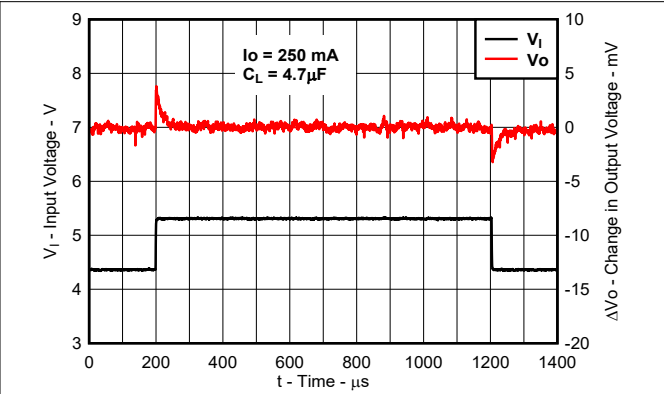

Figure 7-5. TPS76633 Line Transient Response (New Chip)

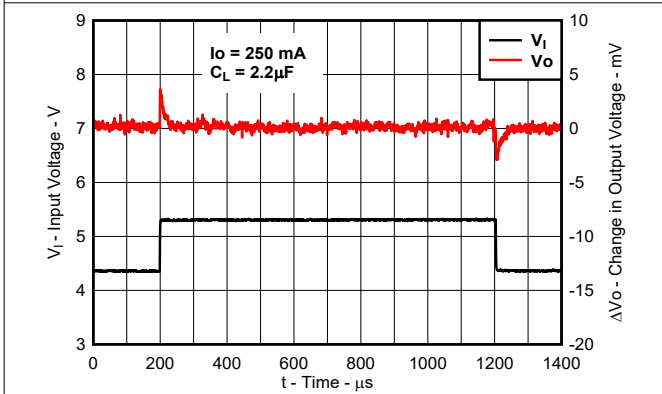

Figure 7-6. TPS76633 Line Transient Response (New Chip)

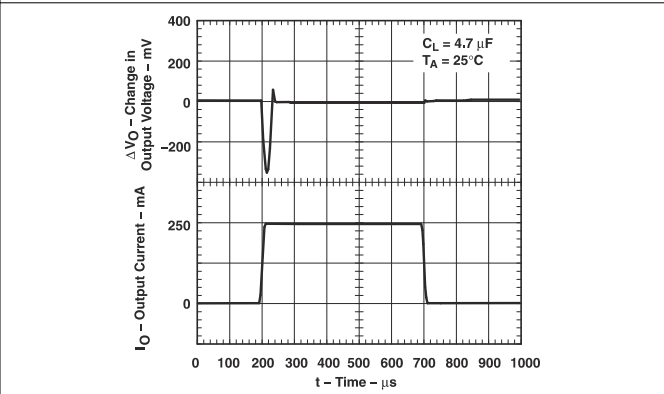

Figure 7-7. TPS76633 Load Transient Response (Legacy Chip)

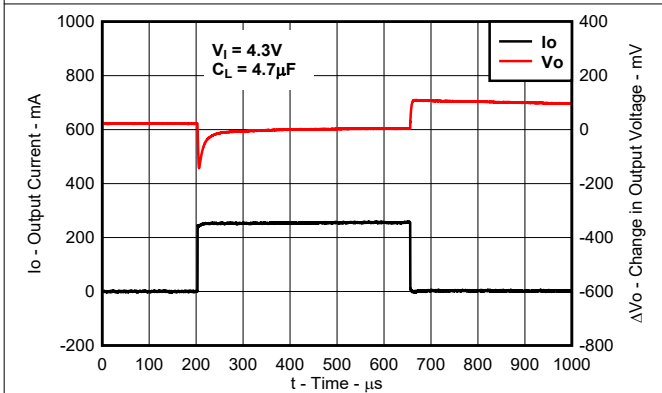

Figure 7-8. TPS76633 Load Transient Response (New Chip)

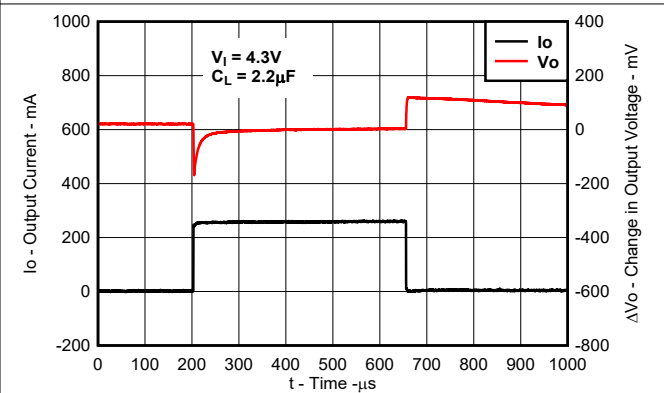

Figure 7-9. TPS76633 Load Transient Response (New Chip)

TPS766

SLVS237E – AUGUST 1999 – REVISED MARCH 2024

7.2.3 Application Curves (continued)

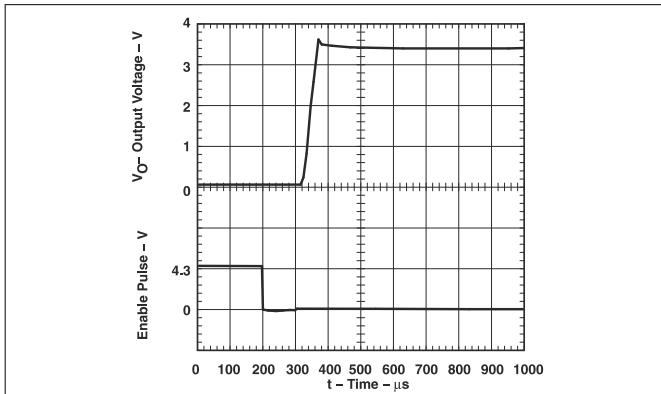
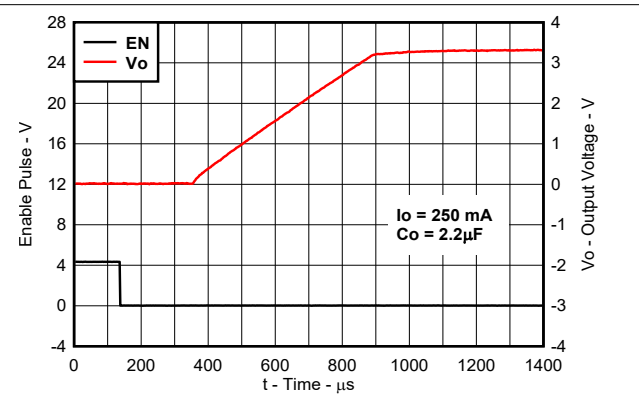
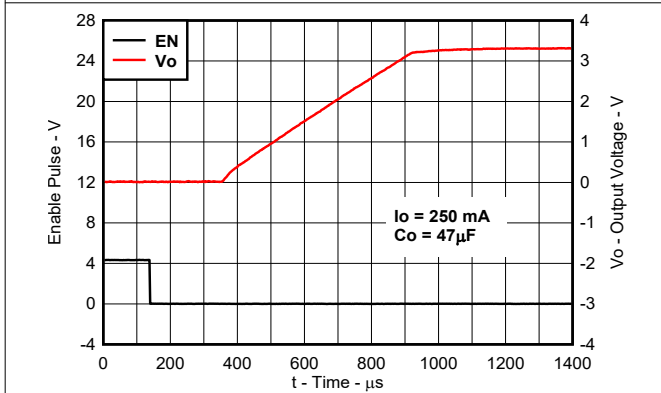

Figure 7-10. TPS76633 Output Voltage vs Time (Legacy Chip)



Start-up with \overline{EN} sequencing

Figure 7-11. TPS76633 Output Voltage vs Time (New Chip)



Start-up with \overline{EN} sequencing

Figure 7-12. TPS76633 Output Voltage vs Time (New Chip)

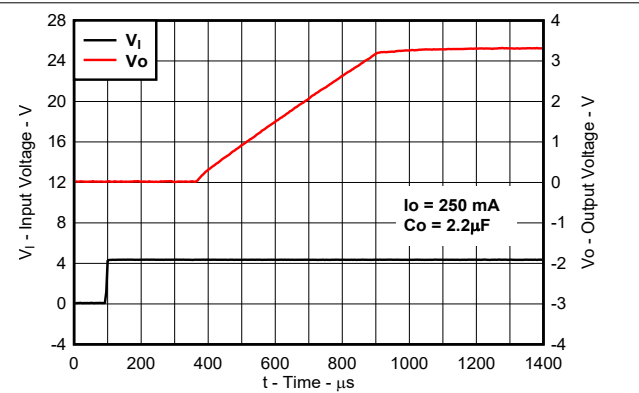

Start-up with V_{IN} sequencing

Figure 7-13. TPS76633 Output Voltage vs Time (New Chip)

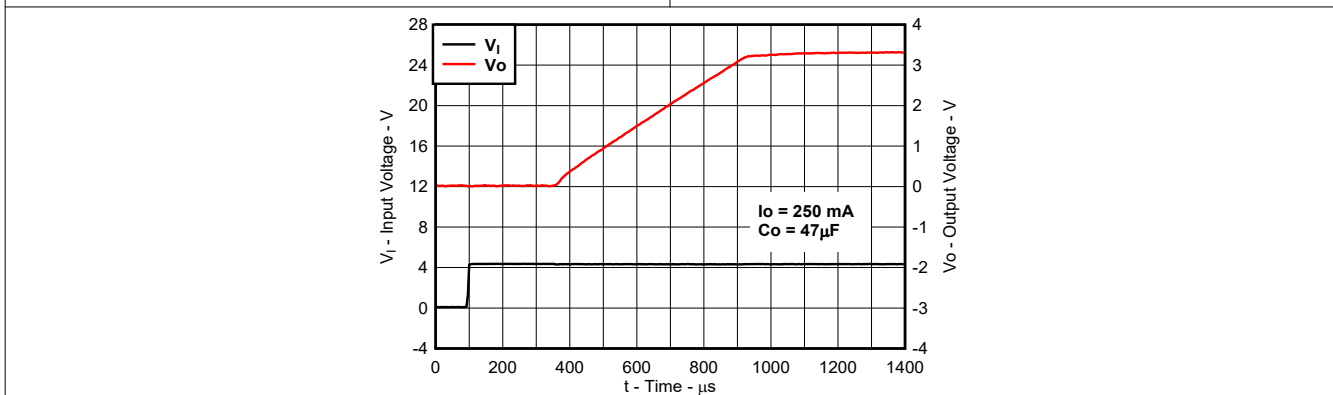

Start-up with V_{IN} sequencing

Figure 7-14. TPS76633 Output Voltage vs Time (New Chip)

7.3 Power Supply Recommendations

The TPS766 is designed to operate from an input voltage supply range between 2.5V and 16V (new chip). The input voltage range provides adequate headroom for the device to have a regulated output. If the input supply is noisy, additional input capacitors with low ESR help improve the output noise performance.

7.4 Layout

7.4.1 Layout Guidelines

For best overall performance, place all circuit components on the same side of the printed circuit board (PCB) and as near as practical to the respective LDO pin connections. Place ground return connections for the input and output capacitors as close to the GND pin as possible, using wide, component-side, copper planes. Do not use vias and long traces to create LDO circuit connections to the input capacitor, output capacitor, or the resistor divider because this practice negatively affects system performance. This grounding and layout scheme minimizes inductive parasitics, and thereby reduces load current transients, minimizes noise, and increases circuit stability. A ground reference plane is also recommended and is either embedded in the PCB or located on the bottom side of the PCB opposite the components. This reference plane serves to design for the accuracy of the output voltage and shield the LDO from noise.

7.4.2 Layout Example

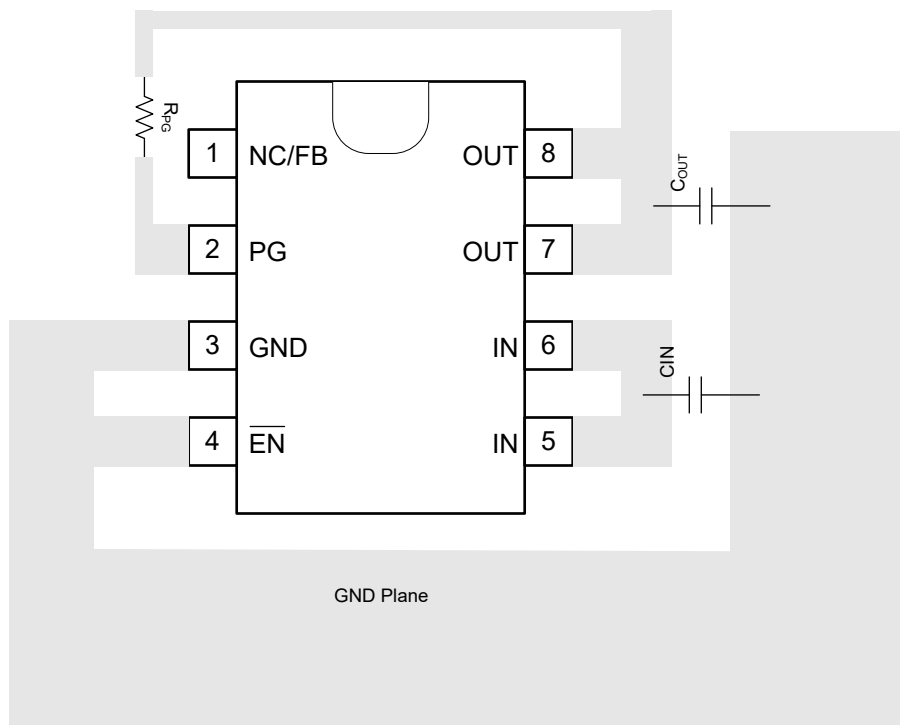

Figure 7-15. Fixed Version Example Layout

TPS766

SLVS237E – AUGUST 1999 – REVISED MARCH 2024

8 Device and Documentation Support

TI offers an extensive line of development tools. Tools and software to evaluate the performance of the device, generate code, and develop solutions are listed in this section.

8.1 Documentation Support

8.1.1 Device Nomenclature

Table 8-1. Device Nomenclature⁽¹⁾⁽²⁾

PRODUCT	V _{OUT}
TPS766xxyz Legacy chip	xx is the nominal output voltage (for example, 33 = 3.3V, 01 = adjustable). y is the package designator. z is the package quantity.
TPS766xxyz M3 New chip	xx is the nominal output voltage (for example, 33 = 3.3V, 01 = adjustable). yyy is the package designator. z is the package quantity. M3 is a suffix designator for new chip redesigns on the latest TI process technology.

- (1) For the most current package and ordering information see the Package Option Addendum at the end of this document, or see the TI web site at www.ti.com.
- (2) Output voltages from 1.25V to 12V are available through the use of innovative factory EEPROM programming; minimum order quantities may apply. Contact factory for details and availability.

8.2 Receiving Notification of Documentation Updates

To receive notification of documentation updates, navigate to the device product folder on ti.com. Click on *Notifications* to register and receive a weekly digest of any product information that has changed. For change details, review the revision history included in any revised document.

8.3 Support Resources

[TI E2E™ support forums](#) are an engineer's go-to source for fast, verified answers and design help — straight from the experts. Search existing answers or ask your own question to get the quick design help you need.

Linked content is provided "AS IS" by the respective contributors. They do not constitute TI specifications and do not necessarily reflect TI's views; see TI's [Terms of Use](#).

8.4 Trademarks

TI E2E™ is a trademark of Texas Instruments.

All trademarks are the property of their respective owners.

8.5 Electrostatic Discharge Caution



This integrated circuit can be damaged by ESD. Texas Instruments recommends that all integrated circuits be handled with appropriate precautions. Failure to observe proper handling and installation procedures can cause damage.

ESD damage can range from subtle performance degradation to complete device failure. Precision integrated circuits may be more susceptible to damage because very small parametric changes could cause the device not to meet its published specifications.

8.6 Glossary

[TI Glossary](#) This glossary lists and explains terms, acronyms, and definitions.

9 Revision History

NOTE: Page numbers for previous revisions may differ from page numbers in the current version.

Changes from Revision D (December 2023) to Revision E (March 2024)	Page
• Changed ESD ratings for the new chip.....	5
• Changed > to ≥ for inclusion of 3.3 V in the output range.....	7

Changes from Revision C (January 2009) to Revision D (December 2023)
Page

• Updated the numbering format for tables, figures, and cross-references throughout the document.....	1
• Added <i>Applications, ESD Ratings, Thermal Information, Overview, Feature Description, Device Functional Modes, Application and Implementation, Power Supply Recommendations, Layout, Device and Documentation, and Mechanical, Packaging, and Orderable Information</i> sections, and <i>Package Information</i> table.....	1
• Changed entire document to align with current family format.....	1
• Added M3 devices to document.....	1
• Added <i>Device Nomenclature</i> section.....	34

10 Mechanical, Packaging, and Orderable Information

The following pages include mechanical, packaging, and orderable information. This information is the most current data available for the designated devices. This data is subject to change without notice and revision of this document. For browser-based versions of this data sheet, refer to the left-hand navigation.

PACKAGING INFORMATION

Orderable Device	Status (1)	Package Type	Package Drawing	Pins	Package Qty	Eco Plan (2)	Lead finish/ Ball material (6)	MSL Peak Temp (3)	Op Temp (°C)	Device Marking (4/5)	Samples
TPS76601D	ACTIVE	SOIC	D	8	75	RoHS & Green	NIPDAU	Level-1-260C-UNLIM		76601	Samples
TPS76601DG4	ACTIVE	SOIC	D	8	75	RoHS & Green	NIPDAU	Level-1-260C-UNLIM		76601	Samples
TPS76601DR	ACTIVE	SOIC	D	8	2500	RoHS & Green	NIPDAU	Level-1-260C-UNLIM		76601	Samples
TPS76615D	ACTIVE	SOIC	D	8	75	RoHS & Green	NIPDAU	Level-1-260C-UNLIM		76615	Samples
TPS76615DR	ACTIVE	SOIC	D	8	2500	RoHS & Green	NIPDAU	Level-1-260C-UNLIM		76615	Samples
TPS76618D	ACTIVE	SOIC	D	8	75	RoHS & Green	NIPDAU	Level-1-260C-UNLIM		76618	Samples
TPS76618DR	ACTIVE	SOIC	D	8	2500	RoHS & Green	NIPDAU	Level-1-260C-UNLIM		76618	Samples
TPS76625D	ACTIVE	SOIC	D	8	75	RoHS & Green	NIPDAU	Level-1-260C-UNLIM		76625	Samples
TPS76625DR	ACTIVE	SOIC	D	8	2500	RoHS & Green	NIPDAU	Level-1-260C-UNLIM		76625	Samples
TPS76628D	ACTIVE	SOIC	D	8	75	RoHS & Green	NIPDAU	Level-1-260C-UNLIM		76628	Samples
TPS76628DR	ACTIVE	SOIC	D	8	2500	RoHS & Green	NIPDAU	Level-1-260C-UNLIM		76628	Samples
TPS76630D	ACTIVE	SOIC	D	8	75	RoHS & Green	NIPDAU	Level-1-260C-UNLIM		76630	Samples
TPS76633D	OBSOLETE	SOIC	D	8		TBD	Call TI	Call TI	-40 to 125	76633	
TPS76633DR	ACTIVE	SOIC	D	8	2500	RoHS & Green	NIPDAU	Level-1-260C-UNLIM	-40 to 125	76633	Samples
TPS76633DRM3	ACTIVE	SOIC	D	8	3000	RoHS & Green	NIPDAU	Level-1-260C-UNLIM	-40 to 125	76633	Samples
TPS76650D	ACTIVE	SOIC	D	8	75	RoHS & Green	NIPDAU	Level-1-260C-UNLIM		76650	Samples
TPS76650DR	ACTIVE	SOIC	D	8	2500	RoHS & Green	NIPDAU	Level-1-260C-UNLIM		76650	Samples
TPS76650DRG4	ACTIVE	SOIC	D	8	2500	RoHS & Green	NIPDAU	Level-1-260C-UNLIM		76650	Samples
TPS76650DRM3	ACTIVE	SOIC	D	8	3000	RoHS & Green	NIPDAU	Level-1-260C-UNLIM	-40 to 125	76650	Samples

(1) The marketing status values are defined as follows:
ACTIVE: Product device recommended for new designs.

LIFEBUY: TI has announced that the device will be discontinued, and a lifetime-buy period is in effect.

NRND: Not recommended for new designs. Device is in production to support existing customers, but TI does not recommend using this part in a new design.

PREVIEW: Device has been announced but is not in production. Samples may or may not be available.

OBSOLETE: TI has discontinued the production of the device.

⁽²⁾ **RoHS:** TI defines "RoHS" to mean semiconductor products that are compliant with the current EU RoHS requirements for all 10 RoHS substances, including the requirement that RoHS substance do not exceed 0.1% by weight in homogeneous materials. Where designed to be soldered at high temperatures, "RoHS" products are suitable for use in specified lead-free processes. TI may reference these types of products as "Pb-Free".

RoHS Exempt: TI defines "RoHS Exempt" to mean products that contain lead but are compliant with EU RoHS pursuant to a specific EU RoHS exemption.

Green: TI defines "Green" to mean the content of Chlorine (Cl) and Bromine (Br) based flame retardants meet JS709B low halogen requirements of ≤ 1000 ppm threshold. Antimony trioxide based flame retardants must also meet the ≤ 1000 ppm threshold requirement.

⁽³⁾ MSL, Peak Temp. - The Moisture Sensitivity Level rating according to the JEDEC industry standard classifications, and peak solder temperature.

⁽⁴⁾ There may be additional marking, which relates to the logo, the lot trace code information, or the environmental category on the device.

⁽⁵⁾ Multiple Device Markings will be inside parentheses. Only one Device Marking contained in parentheses and separated by a "~" will appear on a device. If a line is indented then it is a continuation of the previous line and the two combined represent the entire Device Marking for that device.

⁽⁶⁾ Lead finish/Ball material - Orderable Devices may have multiple material finish options. Finish options are separated by a vertical ruled line. Lead finish/Ball material values may wrap to two lines if the finish value exceeds the maximum column width.

Important Information and Disclaimer: The information provided on this page represents TI's knowledge and belief as of the date that it is provided. TI bases its knowledge and belief on information provided by third parties, and makes no representation or warranty as to the accuracy of such information. Efforts are underway to better integrate information from third parties. TI has taken and continues to take reasonable steps to provide representative and accurate information but may not have conducted destructive testing or chemical analysis on incoming materials and chemicals. TI and TI suppliers consider certain information to be proprietary, and thus CAS numbers and other limited information may not be available for release.

In no event shall TI's liability arising out of such information exceed the total purchase price of the TI part(s) at issue in this document sold by TI to Customer on an annual basis.

TAPE AND REEL INFORMATION

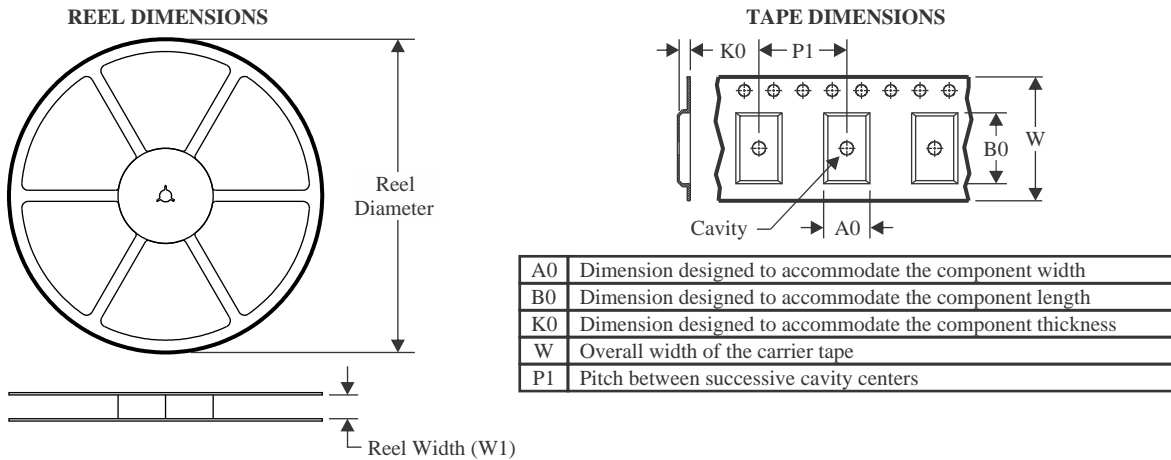

QUADRANT ASSIGNMENTS FOR PIN 1 ORIENTATION IN TAPE

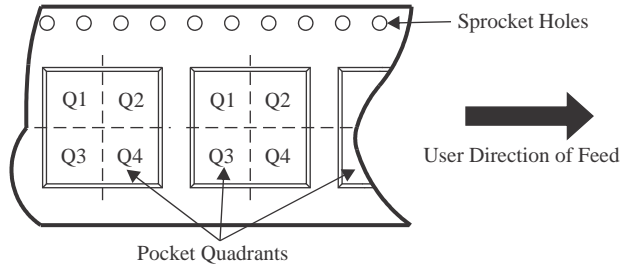

*All dimensions are nominal

Device	Package Type	Package Drawing	Pins	SPQ	Reel Diameter (mm)	Reel Width W1 (mm)	A0 (mm)	B0 (mm)	K0 (mm)	P1 (mm)	W (mm)	Pin1 Quadrant
TPS76601DR	SOIC	D	8	2500	330.0	12.4	6.4	5.2	2.1	8.0	12.0	Q1
TPS76615DR	SOIC	D	8	2500	330.0	12.4	6.4	5.2	2.1	8.0	12.0	Q1
TPS76618DR	SOIC	D	8	2500	330.0	12.4	6.4	5.2	2.1	8.0	12.0	Q1
TPS76625DR	SOIC	D	8	2500	330.0	12.4	6.4	5.2	2.1	8.0	12.0	Q1
TPS76628DR	SOIC	D	8	2500	330.0	12.4	6.4	5.2	2.1	8.0	12.0	Q1
TPS76633DR	SOIC	D	8	2500	330.0	12.4	6.4	5.2	2.1	8.0	12.0	Q1
TPS76633DR	SOIC	D	8	2500	330.0	12.4	6.4	5.2	2.1	8.0	12.0	Q1
TPS76633DRM3	SOIC	D	8	3000	330.0	12.4	6.4	5.2	2.1	8.0	12.0	Q1
TPS76650DR	SOIC	D	8	2500	330.0	12.4	6.4	5.2	2.1	8.0	12.0	Q1
TPS76650DRM3	SOIC	D	8	3000	330.0	12.4	6.4	5.2	2.1	8.0	12.0	Q1

TAPE AND REEL BOX DIMENSIONS

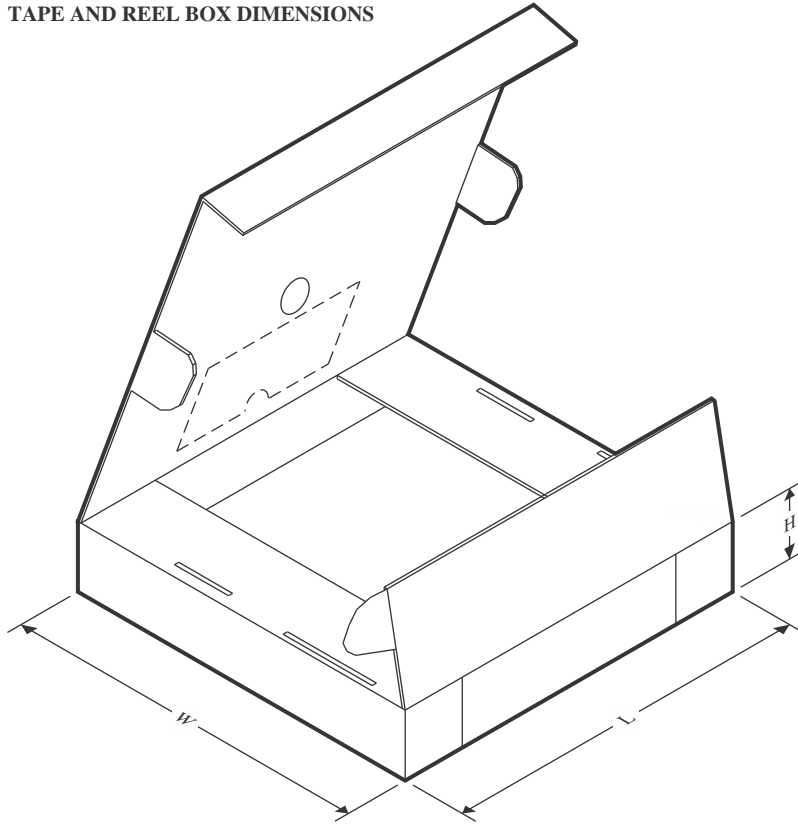

*All dimensions are nominal

Device	Package Type	Package Drawing	Pins	SPQ	Length (mm)	Width (mm)	Height (mm)
TPS76601DR	SOIC	D	8	2500	350.0	350.0	43.0
TPS76615DR	SOIC	D	8	2500	350.0	350.0	43.0
TPS76618DR	SOIC	D	8	2500	353.0	353.0	32.0
TPS76625DR	SOIC	D	8	2500	350.0	350.0	43.0
TPS76628DR	SOIC	D	8	2500	350.0	350.0	43.0
TPS76633DR	SOIC	D	8	2500	356.0	356.0	35.0
TPS76633DR	SOIC	D	8	2500	353.0	353.0	32.0
TPS76633DRM3	SOIC	D	8	3000	356.0	356.0	35.0
TPS76650DR	SOIC	D	8	2500	353.0	353.0	32.0
TPS76650DRM3	SOIC	D	8	3000	356.0	356.0	35.0

TUBE

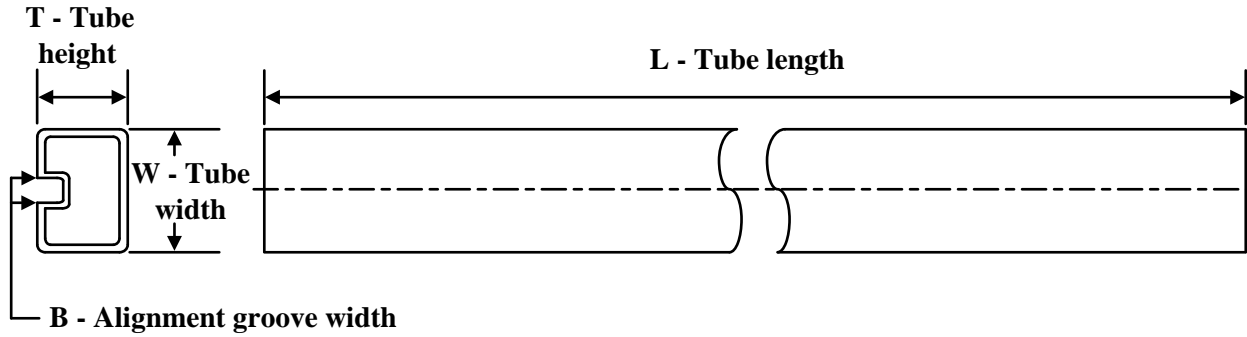

*All dimensions are nominal

Device	Package Name	Package Type	Pins	SPQ	L (mm)	W (mm)	T (μm)	B (mm)
TPS76601D	D	SOIC	8	75	505.46	6.76	3810	4
TPS76601DG4	D	SOIC	8	75	505.46	6.76	3810	4
TPS76615D	D	SOIC	8	75	505.46	6.76	3810	4
TPS76618D	D	SOIC	8	75	505.46	6.76	3810	4
TPS76625D	D	SOIC	8	75	505.46	6.76	3810	4
TPS76628D	D	SOIC	8	75	505.46	6.76	3810	4
TPS76630D	D	SOIC	8	75	505.46	6.76	3810	4
TPS76650D	D	SOIC	8	75	505.46	6.76	3810	4

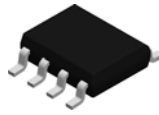

D0008A

PACKAGE OUTLINE

SOIC - 1.75 mm max height

SMALL OUTLINE INTEGRATED CIRCUIT

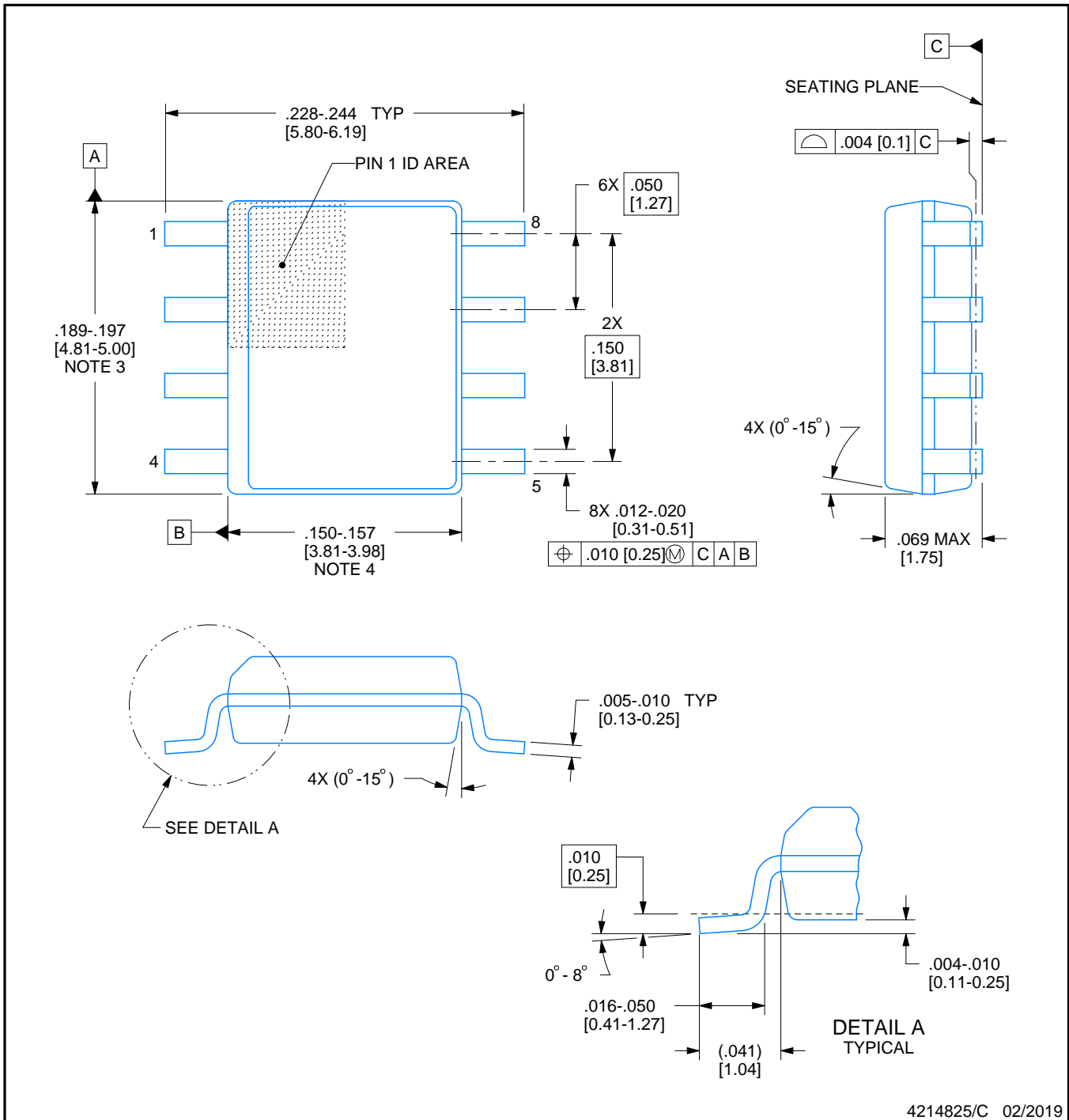

4214825/C 02/2019

NOTES:

1. Linear dimensions are in inches [millimeters]. Dimensions in parenthesis are for reference only. Controlling dimensions are in inches. Dimensioning and tolerancing per ASME Y14.5M.
2. This drawing is subject to change without notice.
3. This dimension does not include mold flash, protrusions, or gate burrs. Mold flash, protrusions, or gate burrs shall not exceed $.006$ [0.15] per side.
4. This dimension does not include interlead flash.
5. Reference JEDEC registration MS-012, variation AA.

EXAMPLE BOARD LAYOUT

D0008A

SOIC - 1.75 mm max height

SMALL OUTLINE INTEGRATED CIRCUIT

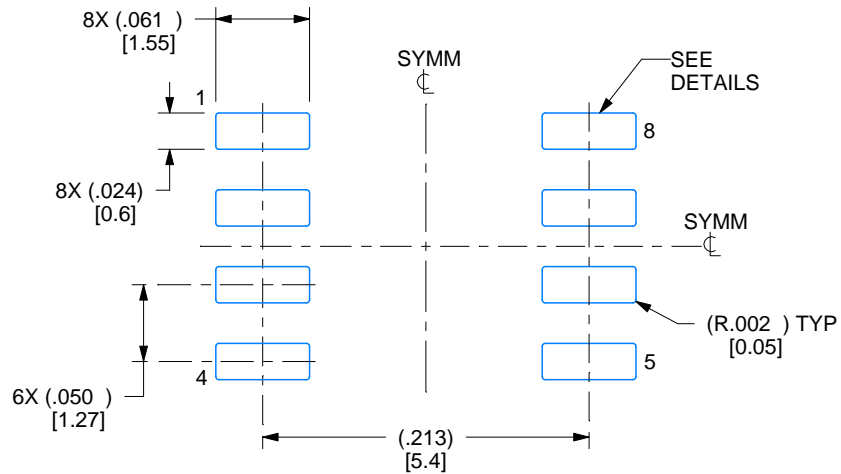

LAND PATTERN EXAMPLE
 EXPOSED METAL SHOWN
 SCALE:8X

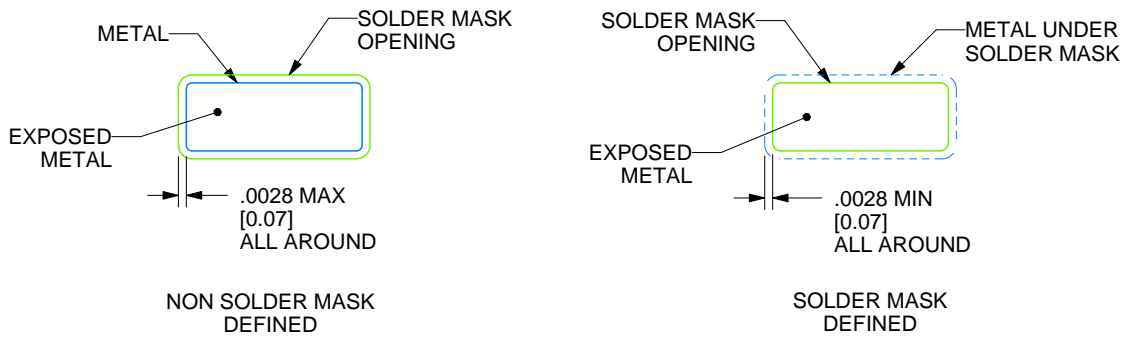

SOLDER MASK DETAILS

4214825/C 02/2019

NOTES: (continued)

- 6. Publication IPC-7351 may have alternate designs.
- 7. Solder mask tolerances between and around signal pads can vary based on board fabrication site.

EXAMPLE STENCIL DESIGN

D0008A

SOIC - 1.75 mm max height

SMALL OUTLINE INTEGRATED CIRCUIT

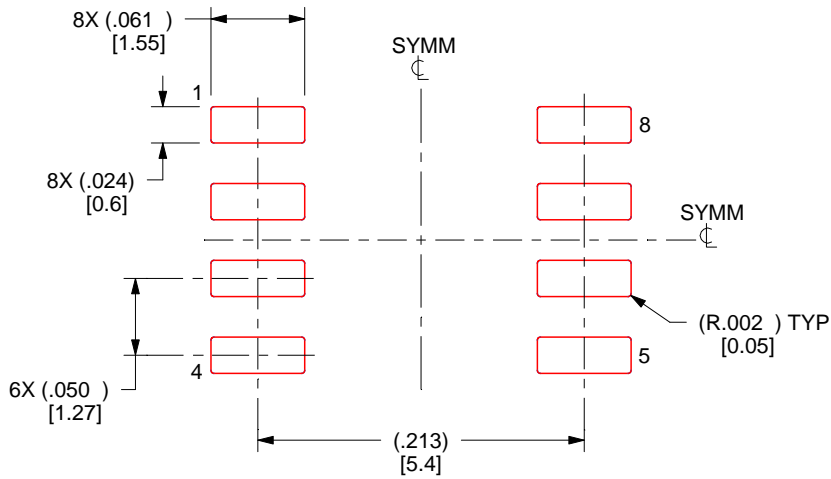

SOLDER PASTE EXAMPLE
 BASED ON .005 INCH [0.125 MM] THICK STENCIL
 SCALE:8X

4214825/C 02/2019

NOTES: (continued)

- 8. Laser cutting apertures with trapezoidal walls and rounded corners may offer better paste release. IPC-7525 may have alternate design recommendations.
- 9. Board assembly site may have different recommendations for stencil design.

IMPORTANT NOTICE AND DISCLAIMER

TI PROVIDES TECHNICAL AND RELIABILITY DATA (INCLUDING DATA SHEETS), DESIGN RESOURCES (INCLUDING REFERENCE DESIGNS), APPLICATION OR OTHER DESIGN ADVICE, WEB TOOLS, SAFETY INFORMATION, AND OTHER RESOURCES "AS IS" AND WITH ALL FAULTS, AND DISCLAIMS ALL WARRANTIES, EXPRESS AND IMPLIED, INCLUDING WITHOUT LIMITATION ANY IMPLIED WARRANTIES OF MERCHANTABILITY, FITNESS FOR A PARTICULAR PURPOSE OR NON-INFRINGEMENT OF THIRD PARTY INTELLECTUAL PROPERTY RIGHTS.

These resources are intended for skilled developers designing with TI products. You are solely responsible for (1) selecting the appropriate TI products for your application, (2) designing, validating and testing your application, and (3) ensuring your application meets applicable standards, and any other safety, security, regulatory or other requirements.

These resources are subject to change without notice. TI grants you permission to use these resources only for development of an application that uses the TI products described in the resource. Other reproduction and display of these resources is prohibited. No license is granted to any other TI intellectual property right or to any third party intellectual property right. TI disclaims responsibility for, and you will fully indemnify TI and its representatives against, any claims, damages, costs, losses, and liabilities arising out of your use of these resources.

TI's products are provided subject to [TI's Terms of Sale](#) or other applicable terms available either on [ti.com](https://www.ti.com) or provided in conjunction with such TI products. TI's provision of these resources does not expand or otherwise alter TI's applicable warranties or warranty disclaimers for TI products.

TI objects to and rejects any additional or different terms you may have proposed.

Mailing Address: Texas Instruments, Post Office Box 655303, Dallas, Texas 75265
Copyright © 2024, Texas Instruments Incorporated

OUR CERTIFICATE

DiGi provide top-quality products and perfect service for customer worldwide through standardization, technological innovation and continuous improvement. DiGi through third-party certification, we stricly control the quality of products and services. Welcome your RFQ to

Email: Info@DiGi-Electronics.com



Tel: +00 852-30501935

RFQ Email: Info@DiGi-Electronics.com

DiGi is a global authorized distributor of electronic components.