

# LQP02TQ10NH02D Datasheet

[www.digi-electronics.com](http://www.digi-electronics.com)

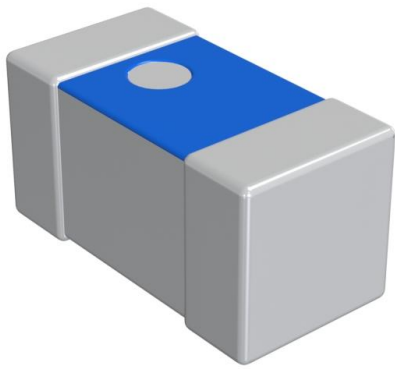

<https://www.DiGi-Electronics.com>

DiGi Electronics Part Number	LQP02TQ10NH02D-DG
Manufacturer	<a href="#">Murata Electronics</a>
Manufacturer Product Number	LQP02TQ10NH02D
Description	FIXED IND 10NH 170MA 1.7 OHM SMD
Detailed Description	10 nH Unshielded Thick Film Inductor 170 mA 1.70 hm Max 01005 (0402 Metric)



Tel: +00 852-30501935

RFQ Email: [Info@DiGi-Electronics.com](mailto:Info@DiGi-Electronics.com)

DiGi is a global authorized distributor of electronic components.

## Purchase and inquiry

Manufacturer Product Number:

LQP02TQ10NH02D

Series:

LQP02

Type:

Thick Film

Inductance:

10 nH

Current Rating (Amps):

170 mA

Shielding:

Unshielded

Q @ Freq:

10 @ 500MHz

Ratings:

-

Inductance Frequency - Test:

500 MHz

Package / Case:

01005 (0402 Metric)

Size / Dimension:

0.016" L x 0.008" W (0.40mm x 0.20mm)

Base Product Number:

LQP02TQ

Manufacturer:

Murata Electronics

Product Status:

Active

Material - Core:

Non-Magnetic

Tolerance:

±3%

Current - Saturation (Isat):

-

DC Resistance (DCR):

1.70hm Max

Frequency - Self Resonant:

5.5GHz

Operating Temperature:

-55°C ~ 125°C

Mounting Type:

Surface Mount

Supplier Device Package:

01005 (0402 Metric)

Height - Seated (Max):

0.009" (0.23mm)

## Environmental & Export classification

RoHS Status:

ROHS3 Compliant

REACH Status:

REACH Unaffected

HTSUS:

8504.50.8000

Moisture Sensitivity Level (MSL):

1 (Unlimited)

ECCN:

EAR99

## CHIP COIL (CHIP INDUCTOR) for Consumer equipment & Industrial equipment LQP02TQ□□□□02□ REFERENCE SPECIFICATION

### 1. Scope

This reference specification applies to chip coil (chip inductor) LQP02TQ\_02 series.

#### 1.1 Specific applications:

- Power equipment: Products that can be used in power equipment such as renewable energy equipment, energy storage equipment and EV charging equipment and whose functions are not directly related to the protection of human life and property.
- Industrial equipment: Products that can be used in industrial equipment such as base stations, manufacturing equipment, industrial robotics equipment, and measurement equipment, and whose functions do not directly relate to the protection of human life and property.
- Medical equipment (GHTF Class C) \*Except for implant/surgery/auto injector: Products that can be used for medical equipment of Class C of the international classification class GHTF and whose malfunction is considered to pose a relatively high risk to the human body.
- Medical equipment (GHTF Class A and B): Products that can be used for medical equipment regulated by Class A and Class B of the international classification class GHTF and whose functions do not directly relate to the protection of human life and property.
- Consumer equipment: Products that can be used in consumer equipment such as home appliances, audio/visual equipment, communication equipment, information equipment, office equipment, and household robotics, and whose functions are not directly related to the protection of human life and property.

#### 1.2 Unsuitable application:

Applications listed in "Limitation of applications" in this reference specification.

### 2. Part Numbering

(Ex.) LQ	P	02	T	Q	0N2	B	0	2	D
Product ID	Structure	Dimension (L × W)	Application and characteristic	Category	Inductance	Tolerance	Performance	Electrode specification	Packaging L: 4 mm width /plastic tape D: 8 mm width /paper tape *B: bulk

\*B: Bulk packing is also available (taping condition: however, products without reels are put in plastic bags).

### 3. Part Number and Rating

Operating temperature range	-55°C to +125°C
Storage temperature range	-55°C to +125°C

Customer Part number	Murata Part number	Inductance		Q (Min.)	DC resistance (Ω max.)	Self-resonant frequency (GHz)		Rated current (mA)
		Nominal value (nH)	Tolerance			*Typical value	Lower limit	
	LQP02TQ0N2B02D	0.2	B: ±0.1 nH	-	0.1	>20	16.6	990
	LQP02TQ0N2B02L	0.2	B: ±0.1 nH	-	0.1	>20	16.6	990
	LQP02TQ0N2C02D	0.2	C: ±0.2 nH	-	0.1	>20	16.6	990
	LQP02TQ0N2C02L	0.2	C: ±0.2 nH	-	0.1	>20	16.6	990
	LQP02TQ0N3B02D	0.3	B: ±0.1 nH	-	0.1	>20	16.6	990
	LQP02TQ0N3B02L	0.3	B: ±0.1 nH	-	0.1	>20	16.6	990
	LQP02TQ0N3C02D	0.3	C: ±0.2 nH	-	0.1	>20	16.6	990
	LQP02TQ0N3C02L	0.3	C: ±0.2 nH	-	0.1	>20	16.6	990
	LQP02TQ0N4B02D	0.4	B: ±0.1 nH	10	0.1	>20	16.6	990
	LQP02TQ0N4B02L	0.4	B: ±0.1 nH	10	0.1	>20	16.6	990
	LQP02TQ0N4C02D	0.4	C: ±0.2 nH	10	0.1	>20	16.6	990
	LQP02TQ0N4C02L	0.4	C: ±0.2 nH	10	0.1	>20	16.6	990

Customer Part number	Murata Part number	Inductance		Q (Min.)	DC resistance ( $\Omega$ max.)	Self-resonant frequency (GHz)		Rated current (mA)
		Nominal value (nH)	Tolerance			*Typical value	Lower limit	
	LQP02TQ0N5B02D	0.5	B: $\pm 0.1$ nH	10	0.1	>20	16.6	730
	LQP02TQ0N5B02L	0.5	B: $\pm 0.1$ nH	10	0.1	>20	16.6	730
	LQP02TQ0N5C02D	0.5	C: $\pm 0.2$ nH	10	0.1	>20	16.6	730
	LQP02TQ0N5C02L	0.5	C: $\pm 0.2$ nH	10	0.1	>20	16.6	730
	LQP02TQ0N6B02D	0.6	B: $\pm 0.1$ nH	10	0.1	>20	16.6	730
	LQP02TQ0N6B02L	0.6	B: $\pm 0.1$ nH	10	0.1	>20	16.6	730
	LQP02TQ0N6C02D	0.6	C: $\pm 0.2$ nH	10	0.1	>20	16.6	730
	LQP02TQ0N6C02L	0.6	C: $\pm 0.2$ nH	10	0.1	>20	16.6	730
	LQP02TQ0N7B02D	0.7	B: $\pm 0.1$ nH	10	0.15	>20	16.6	630
	LQP02TQ0N7B02L	0.7	B: $\pm 0.1$ nH	10	0.15	>20	16.6	630
	LQP02TQ0N7C02D	0.7	C: $\pm 0.2$ nH	10	0.15	>20	16.6	630
	LQP02TQ0N7C02L	0.7	C: $\pm 0.2$ nH	10	0.15	>20	16.6	630
	LQP02TQ0N8B02D	0.8	B: $\pm 0.1$ nH	10	0.15	>20	16.6	630
	LQP02TQ0N8B02L	0.8	B: $\pm 0.1$ nH	10	0.15	>20	16.6	630
	LQP02TQ0N8C02D	0.8	C: $\pm 0.2$ nH	10	0.15	>20	16.6	630
	LQP02TQ0N8C02L	0.8	C: $\pm 0.2$ nH	10	0.15	>20	16.6	630
	LQP02TQ0N9B02D	0.9	B: $\pm 0.1$ nH	10	0.15	>20	16.6	580
	LQP02TQ0N9B02L	0.9	B: $\pm 0.1$ nH	10	0.15	>20	16.6	580
	LQP02TQ0N9C02D	0.9	C: $\pm 0.2$ nH	10	0.15	>20	16.6	580
	LQP02TQ0N9C02L	0.9	C: $\pm 0.2$ nH	10	0.15	>20	16.6	580
	LQP02TQ1N0B02D	1.0	B: $\pm 0.1$ nH	10	0.15	>20	16.6	580
	LQP02TQ1N0B02L	1.0	B: $\pm 0.1$ nH	10	0.15	>20	16.6	580
	LQP02TQ1N0C02D	1.0	C: $\pm 0.2$ nH	10	0.15	>20	16.6	580
	LQP02TQ1N0C02L	1.0	C: $\pm 0.2$ nH	10	0.15	>20	16.6	580
	LQP02TQ1N1B02D	1.1	B: $\pm 0.1$ nH	10	0.2	>20	16.6	570
	LQP02TQ1N1B02L	1.1	B: $\pm 0.1$ nH	10	0.2	>20	16.6	570
	LQP02TQ1N1C02D	1.1	C: $\pm 0.2$ nH	10	0.2	>20	16.6	570
	LQP02TQ1N1C02L	1.1	C: $\pm 0.2$ nH	10	0.2	>20	16.6	570
	LQP02TQ1N2B02D	1.2	B: $\pm 0.1$ nH	10	0.2	19.6	16.6	550
	LQP02TQ1N2B02L	1.2	B: $\pm 0.1$ nH	10	0.2	19.6	16.6	550
	LQP02TQ1N2C02D	1.2	C: $\pm 0.2$ nH	10	0.2	19.6	16.6	550
	LQP02TQ1N2C02L	1.2	C: $\pm 0.2$ nH	10	0.2	19.6	16.6	550
	LQP02TQ1N3B02D	1.3	B: $\pm 0.1$ nH	10	0.2	>20	15.0	400
	LQP02TQ1N3B02L	1.3	B: $\pm 0.1$ nH	10	0.2	>20	15.0	400
	LQP02TQ1N3C02D	1.3	C: $\pm 0.2$ nH	10	0.2	>20	15.0	400
	LQP02TQ1N3C02L	1.3	C: $\pm 0.2$ nH	10	0.2	>20	15.0	400
	LQP02TQ1N4B02D	1.4	B: $\pm 0.1$ nH	10	0.2	19	15.0	400
	LQP02TQ1N4B02L	1.4	B: $\pm 0.1$ nH	10	0.2	19	15.0	400
	LQP02TQ1N4C02D	1.4	C: $\pm 0.2$ nH	10	0.2	19	15.0	400
	LQP02TQ1N4C02L	1.4	C: $\pm 0.2$ nH	10	0.2	19	15.0	400
	LQP02TQ1N5B02D	1.5	B: $\pm 0.1$ nH	10	0.2	>20	15.0	400
	LQP02TQ1N5B02L	1.5	B: $\pm 0.1$ nH	10	0.2	>20	15.0	400
	LQP02TQ1N5C02D	1.5	C: $\pm 0.2$ nH	10	0.2	>20	15.0	400
	LQP02TQ1N5C02L	1.5	C: $\pm 0.2$ nH	10	0.2	>20	15.0	400

Customer Part number	Murata Part number	Inductance		Q (Min.)	DC resistance ( $\Omega$ max.)	Self-resonant frequency (GHz)		Rated current (mA)
		Nominal value (nH)	Tolerance			*Typical value	Lower limit	
	LQP02TQ1N6B02D	1.6	B: $\pm 0.1$ nH	10	0.3	18.9	15.0	390
	LQP02TQ1N6B02L	1.6	B: $\pm 0.1$ nH	10	0.3	18.9	15.0	390
	LQP02TQ1N6C02D	1.6	C: $\pm 0.2$ nH	10	0.3	18.9	15.0	390
	LQP02TQ1N6C02L	1.6	C: $\pm 0.2$ nH	10	0.3	18.9	15.0	390
	LQP02TQ1N7B02D	1.7	B: $\pm 0.1$ nH	10	0.3	19.0	15.0	380
	LQP02TQ1N7B02L	1.7	B: $\pm 0.1$ nH	10	0.3	19.0	15.0	380
	LQP02TQ1N7C02D	1.7	C: $\pm 0.2$ nH	10	0.3	19.0	15.0	380
	LQP02TQ1N7C02L	1.7	C: $\pm 0.2$ nH	10	0.3	19.0	15.0	380
	LQP02TQ1N8B02D	1.8	B: $\pm 0.1$ nH	10	0.3	17.7	15.0	380
	LQP02TQ1N8B02L	1.8	B: $\pm 0.1$ nH	10	0.3	17.7	15.0	380
	LQP02TQ1N8C02D	1.8	C: $\pm 0.2$ nH	10	0.3	17.7	15.0	380
	LQP02TQ1N8C02L	1.8	C: $\pm 0.2$ nH	10	0.3	17.7	15.0	380
	LQP02TQ1N9B02D	1.9	B: $\pm 0.1$ nH	10	0.3	16.8	13.0	380
	LQP02TQ1N9B02L	1.9	B: $\pm 0.1$ nH	10	0.3	16.8	13.0	380
	LQP02TQ1N9C02D	1.9	C: $\pm 0.2$ nH	10	0.3	16.8	13.0	380
	LQP02TQ1N9C02L	1.9	C: $\pm 0.2$ nH	10	0.3	16.8	13.0	380
	LQP02TQ2N0B02D	2.0	B: $\pm 0.1$ nH	10	0.3	15.4	13.0	380
	LQP02TQ2N0B02L	2.0	B: $\pm 0.1$ nH	10	0.3	15.4	13.0	380
	LQP02TQ2N0C02D	2.0	C: $\pm 0.2$ nH	10	0.3	15.4	13.0	380
	LQP02TQ2N0C02L	2.0	C: $\pm 0.2$ nH	10	0.3	15.4	13.0	380
	LQP02TQ2N1B02D	2.1	B: $\pm 0.1$ nH	10	0.3	14.6	13.0	380
	LQP02TQ2N1B02L	2.1	B: $\pm 0.1$ nH	10	0.3	14.6	13.0	380
	LQP02TQ2N1C02D	2.1	C: $\pm 0.2$ nH	10	0.3	14.6	13.0	380
	LQP02TQ2N1C02L	2.1	C: $\pm 0.2$ nH	10	0.3	14.6	13.0	380
	LQP02TQ2N2B02D	2.2	B: $\pm 0.1$ nH	10	0.3	16.3	13.0	380
	LQP02TQ2N2B02L	2.2	B: $\pm 0.1$ nH	10	0.3	16.3	13.0	380
	LQP02TQ2N2C02D	2.2	C: $\pm 0.2$ nH	10	0.3	16.3	13.0	380
	LQP02TQ2N2C02L	2.2	C: $\pm 0.2$ nH	10	0.3	16.3	13.0	380
	LQP02TQ2N3B02D	2.3	B: $\pm 0.1$ nH	10	0.4	16.2	13.0	370
	LQP02TQ2N3B02L	2.3	B: $\pm 0.1$ nH	10	0.4	16.2	13.0	370
	LQP02TQ2N3C02D	2.3	C: $\pm 0.2$ nH	10	0.4	16.2	13.0	370
	LQP02TQ2N3C02L	2.3	C: $\pm 0.2$ nH	10	0.4	16.2	13.0	370
	LQP02TQ2N4B02D	2.4	B: $\pm 0.1$ nH	10	0.4	16.2	13.0	370
	LQP02TQ2N4B02L	2.4	B: $\pm 0.1$ nH	10	0.4	16.2	13.0	370
	LQP02TQ2N4C02D	2.4	C: $\pm 0.2$ nH	10	0.4	16.2	13.0	370
	LQP02TQ2N4C02L	2.4	C: $\pm 0.2$ nH	10	0.4	16.2	13.0	370
	LQP02TQ2N5B02D	2.5	B: $\pm 0.1$ nH	10	0.4	14.9	11.5	370
	LQP02TQ2N5B02L	2.5	B: $\pm 0.1$ nH	10	0.4	14.9	11.5	370
	LQP02TQ2N5C02D	2.5	C: $\pm 0.2$ nH	10	0.4	14.9	11.5	370
	LQP02TQ2N5C02L	2.5	C: $\pm 0.2$ nH	10	0.4	14.9	11.5	370
	LQP02TQ2N6B02D	2.6	B: $\pm 0.1$ nH	10	0.4	14.6	11.5	370
	LQP02TQ2N6B02L	2.6	B: $\pm 0.1$ nH	10	0.4	14.6	11.5	370
	LQP02TQ2N6C02D	2.6	C: $\pm 0.2$ nH	10	0.4	14.6	11.5	370
	LQP02TQ2N6C02L	2.6	C: $\pm 0.2$ nH	10	0.4	14.6	11.5	370

Customer Part number	Murata Part number	Inductance		Q (Min.)	DC resistance ( $\Omega$ max.)	Self-resonant frequency (GHz)		Rated current (mA)
		Nominal value (nH)	Tolerance			*Typical value	Lower limit	
	LQP02TQ2N7B02D	2.7	B: $\pm 0.1$ nH	10	0.4	13.5	11.5	370
	LQP02TQ2N7B02L	2.7	B: $\pm 0.1$ nH	10	0.4	13.5	11.5	370
	LQP02TQ2N7C02D	2.7	C: $\pm 0.2$ nH	10	0.4	13.5	11.5	370
	LQP02TQ2N7C02L	2.7	C: $\pm 0.2$ nH	10	0.4	13.5	11.5	370
	LQP02TQ2N8B02D	2.8	B: $\pm 0.1$ nH	10	0.45	12.8	10.0	360
	LQP02TQ2N8B02L	2.8	B: $\pm 0.1$ nH	10	0.45	12.8	10.0	360
	LQP02TQ2N8C02D	2.8	C: $\pm 0.2$ nH	10	0.45	12.8	10.0	360
	LQP02TQ2N8C02L	2.8	C: $\pm 0.2$ nH	10	0.45	12.8	10.0	360
	LQP02TQ2N9B02D	2.9	B: $\pm 0.1$ nH	10	0.45	12.3	10.0	360
	LQP02TQ2N9B02L	2.9	B: $\pm 0.1$ nH	10	0.45	12.3	10.0	360
	LQP02TQ2N9C02D	2.9	C: $\pm 0.2$ nH	10	0.45	12.3	10.0	360
	LQP02TQ2N9C02L	2.9	C: $\pm 0.2$ nH	10	0.45	12.3	10.0	360
	LQP02TQ3N0B02D	3.0	B: $\pm 0.1$ nH	10	0.45	12.2	10.0	360
	LQP02TQ3N0B02L	3.0	B: $\pm 0.1$ nH	10	0.45	12.2	10.0	360
	LQP02TQ3N0C02D	3.0	C: $\pm 0.2$ nH	10	0.45	12.2	10.0	360
	LQP02TQ3N0C02L	3.0	C: $\pm 0.2$ nH	10	0.45	12.2	10.0	360
	LQP02TQ3N1B02D	3.1	B: $\pm 0.1$ nH	10	0.9	12.0	10.0	290
	LQP02TQ3N1B02L	3.1	B: $\pm 0.1$ nH	10	0.9	12.0	10.0	290
	LQP02TQ3N1C02D	3.1	C: $\pm 0.2$ nH	10	0.9	12.0	10.0	290
	LQP02TQ3N1C02L	3.1	C: $\pm 0.2$ nH	10	0.9	12.0	10.0	290
	LQP02TQ3N2B02D	3.2	B: $\pm 0.1$ nH	10	0.9	12.6	10.0	290
	LQP02TQ3N2B02L	3.2	B: $\pm 0.1$ nH	10	0.9	12.6	10.0	290
	LQP02TQ3N2C02D	3.2	C: $\pm 0.2$ nH	10	0.9	12.6	10.0	290
	LQP02TQ3N2C02L	3.2	C: $\pm 0.2$ nH	10	0.9	12.6	10.0	290
	LQP02TQ3N3B02D	3.3	B: $\pm 0.1$ nH	10	0.9	12.2	10.0	290
	LQP02TQ3N3B02L	3.3	B: $\pm 0.1$ nH	10	0.9	12.2	10.0	290
	LQP02TQ3N3C02D	3.3	C: $\pm 0.2$ nH	10	0.9	12.2	10.0	290
	LQP02TQ3N3C02L	3.3	C: $\pm 0.2$ nH	10	0.9	12.2	10.0	290
	LQP02TQ3N4B02D	3.4	B: $\pm 0.1$ nH	10	1.0	12.5	9.7	280
	LQP02TQ3N4B02L	3.4	B: $\pm 0.1$ nH	10	1.0	12.5	9.7	280
	LQP02TQ3N4C02D	3.4	C: $\pm 0.2$ nH	10	1.0	12.5	9.7	280
	LQP02TQ3N4C02L	3.4	C: $\pm 0.2$ nH	10	1.0	12.5	9.7	280
	LQP02TQ3N5B02D	3.5	B: $\pm 0.1$ nH	10	1.0	12.1	9.7	280
	LQP02TQ3N5B02L	3.5	B: $\pm 0.1$ nH	10	1.0	12.1	9.7	280
	LQP02TQ3N5C02D	3.5	C: $\pm 0.2$ nH	10	1.0	12.1	9.7	280
	LQP02TQ3N5C02L	3.5	C: $\pm 0.2$ nH	10	1.0	12.1	9.7	280
	LQP02TQ3N6B02D	3.6	B: $\pm 0.1$ nH	10	1.0	11.5	9.7	280
	LQP02TQ3N6B02L	3.6	B: $\pm 0.1$ nH	10	1.0	11.5	9.7	280
	LQP02TQ3N6C02D	3.6	C: $\pm 0.2$ nH	10	1.0	11.5	9.7	280
	LQP02TQ3N6C02L	3.6	C: $\pm 0.2$ nH	10	1.0	11.5	9.7	280
	LQP02TQ3N7B02D	3.7	B: $\pm 0.1$ nH	10	1.0	11.4	9.7	270
	LQP02TQ3N7B02L	3.7	B: $\pm 0.1$ nH	10	1.0	11.4	9.7	270
	LQP02TQ3N7C02D	3.7	C: $\pm 0.2$ nH	10	1.0	11.4	9.7	270
	LQP02TQ3N7C02L	3.7	C: $\pm 0.2$ nH	10	1.0	11.4	9.7	270

Customer Part number	Murata Part number	Inductance		Q (Min.)	DC resistance ( $\Omega$ max.)	Self-resonant frequency (GHz)		Rated current (mA)
		Nominal value (nH)	Tolerance			*Typical value	Lower limit	
	LQP02TQ3N8B02D	3.8	B: $\pm 0.1$ nH	10	1.0	11.1	9.7	270
	LQP02TQ3N8B02L	3.8	B: $\pm 0.1$ nH	10	1.0	11.1	9.7	270
	LQP02TQ3N8C02D	3.8	C: $\pm 0.2$ nH	10	1.0	11.1	9.7	270
	LQP02TQ3N8C02L	3.8	C: $\pm 0.2$ nH	10	1.0	11.1	9.7	270
	LQP02TQ3N9B02D	3.9	B: $\pm 0.1$ nH	10	1.0	10.7	9.0	270
	LQP02TQ3N9B02L	3.9	B: $\pm 0.1$ nH	10	1.0	10.7	9.0	270
	LQP02TQ3N9C02D	3.9	C: $\pm 0.2$ nH	10	1.0	10.7	9.0	270
	LQP02TQ3N9C02L	3.9	C: $\pm 0.2$ nH	10	1.0	10.7	9.0	270
	LQP02TQ4N0B02D	4.0	B: $\pm 0.1$ nH	10	1.0	10.5	9.0	270
	LQP02TQ4N0B02L	4.0	B: $\pm 0.1$ nH	10	1.0	10.5	9.0	270
	LQP02TQ4N0C02D	4.0	C: $\pm 0.2$ nH	10	1.0	10.5	9.0	270
	LQP02TQ4N0C02L	4.0	C: $\pm 0.2$ nH	10	1.0	10.5	9.0	270
	LQP02TQ4N1B02D	4.1	B: $\pm 0.1$ nH	10	1.0	10.3	9.0	270
	LQP02TQ4N1B02L	4.1	B: $\pm 0.1$ nH	10	1.0	10.3	9.0	270
	LQP02TQ4N1C02D	4.1	C: $\pm 0.2$ nH	10	1.0	10.3	9.0	270
	LQP02TQ4N1C02L	4.1	C: $\pm 0.2$ nH	10	1.0	10.3	9.0	270
	LQP02TQ4N2B02D	4.2	B: $\pm 0.1$ nH	10	1.0	11.0	9.0	270
	LQP02TQ4N2B02L	4.2	B: $\pm 0.1$ nH	10	1.0	11.0	9.0	270
	LQP02TQ4N2C02D	4.2	C: $\pm 0.2$ nH	10	1.0	11.0	9.0	270
	LQP02TQ4N2C02L	4.2	C: $\pm 0.2$ nH	10	1.0	11.0	9.0	270
	LQP02TQ4N3H02D	4.3	H: $\pm 3\%$	10	1.0	10.8	9.0	270
	LQP02TQ4N3H02L	4.3	H: $\pm 3\%$	10	1.0	10.8	9.0	270
	LQP02TQ4N3J02D	4.3	J: $\pm 5\%$	10	1.0	10.8	9.0	270
	LQP02TQ4N3J02L	4.3	J: $\pm 5\%$	10	1.0	10.8	9.0	270
	LQP02TQ4N7H02D	4.7	H: $\pm 3\%$	10	1.0	9.6	8.5	270
	LQP02TQ4N7H02L	4.7	H: $\pm 3\%$	10	1.0	9.6	8.5	270
	LQP02TQ4N7J02D	4.7	J: $\pm 5\%$	10	1.0	9.6	8.5	270
	LQP02TQ4N7J02L	4.7	J: $\pm 5\%$	10	1.0	9.6	8.5	270
	LQP02TQ5N1H02D	5.1	H: $\pm 3\%$	10	1.2	9.2	7.8	250
	LQP02TQ5N1H02L	5.1	H: $\pm 3\%$	10	1.2	9.2	7.8	250
	LQP02TQ5N1J02D	5.1	J: $\pm 5\%$	10	1.2	9.2	7.8	250
	LQP02TQ5N1J02L	5.1	J: $\pm 5\%$	10	1.2	9.2	7.8	250
	LQP02TQ5N6H02D	5.6	H: $\pm 3\%$	10	1.3	9.4	7.8	230
	LQP02TQ5N6H02L	5.6	H: $\pm 3\%$	10	1.3	9.4	7.8	230
	LQP02TQ5N6J02D	5.6	J: $\pm 5\%$	10	1.3	9.4	7.8	230
	LQP02TQ5N6J02L	5.6	J: $\pm 5\%$	10	1.3	9.4	7.8	230
	LQP02TQ6N2H02D	6.2	H: $\pm 3\%$	10	1.3	8.5	7.2	220
	LQP02TQ6N2H02L	6.2	H: $\pm 3\%$	10	1.3	8.5	7.2	220
	LQP02TQ6N2J02D	6.2	J: $\pm 5\%$	10	1.3	8.5	7.2	220
	LQP02TQ6N2J02L	6.2	J: $\pm 5\%$	10	1.3	8.5	7.2	220
	LQP02TQ6N8H02D	6.8	H: $\pm 3\%$	10	1.4	7.8	6.6	210
	LQP02TQ6N8H02L	6.8	H: $\pm 3\%$	10	1.4	7.8	6.6	210
	LQP02TQ6N8J02D	6.8	J: $\pm 5\%$	10	1.4	7.8	6.6	210
	LQP02TQ6N8J02L	6.8	J: $\pm 5\%$	10	1.4	7.8	6.6	210

Customer Part number	Murata Part number	Inductance		Q (Min.)	DC resistance ( $\Omega$ max.)	Self-resonant frequency (GHz)		Rated current (mA)
		Nominal value (nH)	Tolerance			*Typical value	Lower limit	
	LQP02TQ7N5H02D	7.5	H: $\pm 3\%$	10	1.5	8.1	6.6	200
	LQP02TQ7N5H02L	7.5	H: $\pm 3\%$	10	1.5	8.1	6.6	200
	LQP02TQ7N5J02D	7.5	J: $\pm 5\%$	10	1.5	8.1	6.6	200
	LQP02TQ7N5J02L	7.5	J: $\pm 5\%$	10	1.5	8.1	6.6	200
	LQP02TQ8N2H02D	8.2	H: $\pm 3\%$	10	1.6	7.8	6.6	190
	LQP02TQ8N2H02L	8.2	H: $\pm 3\%$	10	1.6	7.8	6.6	190
	LQP02TQ8N2J02D	8.2	J: $\pm 5\%$	10	1.6	7.8	6.6	190
	LQP02TQ8N2J02L	8.2	J: $\pm 5\%$	10	1.6	7.8	6.6	190
	LQP02TQ9N1H02D	9.1	H: $\pm 3\%$	10	1.7	7.0	5.9	170
	LQP02TQ9N1H02L	9.1	H: $\pm 3\%$	10	1.7	7.0	5.9	170
	LQP02TQ9N1J02D	9.1	J: $\pm 5\%$	10	1.7	7.0	5.9	170
	LQP02TQ9N1J02L	9.1	J: $\pm 5\%$	10	1.7	7.0	5.9	170
	LQP02TQ10NH02D	10	H: $\pm 3\%$	10	1.7	6.5	5.5	170
	LQP02TQ10NH02L	10	H: $\pm 3\%$	10	1.7	6.5	5.5	170
	LQP02TQ10NJ02D	10	J: $\pm 5\%$	10	1.7	6.5	5.5	170
	LQP02TQ10NJ02L	10	J: $\pm 5\%$	10	1.7	6.5	5.5	170
	LQP02TQ11NH02D	11	H: $\pm 3\%$	10	1.9	5.9	3.5	140
	LQP02TQ11NH02L	11	H: $\pm 3\%$	10	1.9	5.9	3.5	140
	LQP02TQ11NJ02D	11	J: $\pm 5\%$	10	1.9	5.9	3.5	140
	LQP02TQ11NJ02L	11	J: $\pm 5\%$	10	1.9	5.9	3.5	140
	LQP02TQ12NH02D	12	H: $\pm 3\%$	10	2.1	5.7	3.5	140
	LQP02TQ12NH02L	12	H: $\pm 3\%$	10	2.1	5.7	3.5	140
	LQP02TQ12NJ02D	12	J: $\pm 5\%$	10	2.1	5.7	3.5	140
	LQP02TQ12NJ02L	12	J: $\pm 5\%$	10	2.1	5.7	3.5	140
	LQP02TQ13NH02D	13	H: $\pm 3\%$	10	2.1	5.6	3.0	140
	LQP02TQ13NH02L	13	H: $\pm 3\%$	10	2.1	5.6	3.0	140
	LQP02TQ13NJ02D	13	J: $\pm 5\%$	10	2.1	5.6	3.0	140
	LQP02TQ13NJ02L	13	J: $\pm 5\%$	10	2.1	5.6	3.0	140
	LQP02TQ14NH02D	14	H: $\pm 3\%$	10	2.3	5.1	3.0	140
	LQP02TQ14NH02L	14	H: $\pm 3\%$	10	2.3	5.1	3.0	140
	LQP02TQ14NJ02D	14	J: $\pm 5\%$	10	2.3	5.1	3.0	140
	LQP02TQ14NJ02L	14	J: $\pm 5\%$	10	2.3	5.1	3.0	140
	LQP02TQ15NH02D	15	H: $\pm 3\%$	10	2.3	5.1	3.0	140
	LQP02TQ15NH02L	15	H: $\pm 3\%$	10	2.3	5.1	3.0	140
	LQP02TQ15NJ02D	15	J: $\pm 5\%$	10	2.3	5.1	3.0	140
	LQP02TQ15NJ02L	15	J: $\pm 5\%$	10	2.3	5.1	3.0	140
	LQP02TQ16NH02D	16	H: $\pm 3\%$	10	2.5	4.9	2.5	140
	LQP02TQ16NH02L	16	H: $\pm 3\%$	10	2.5	4.9	2.5	140
	LQP02TQ16NJ02D	16	J: $\pm 5\%$	10	2.5	4.9	2.5	140
	LQP02TQ16NJ02L	16	J: $\pm 5\%$	10	2.5	4.9	2.5	140
	LQP02TQ17NH02D	17	H: $\pm 3\%$	10	2.5	4.7	2.5	140
	LQP02TQ17NH02L	17	H: $\pm 3\%$	10	2.5	4.7	2.5	140
	LQP02TQ17NJ02D	17	J: $\pm 5\%$	10	2.5	4.7	2.5	140
	LQP02TQ17NJ02L	17	J: $\pm 5\%$	10	2.5	4.7	2.5	140



Customer Part number	Murata Part number	Inductance		Q (Min.)	DC resistance ( $\Omega$ max.)	Self-resonant frequency (GHz)		Rated current (mA)
		Nominal value (nH)	Tolerance			*Typical value	Lower limit	
	LQP02TQ18NH02D	18	H: $\pm 3\%$	8	2.5	4.7	2.5	140
	LQP02TQ18NH02L	18	H: $\pm 3\%$	8	2.5	4.7	2.5	140
	LQP02TQ18NJ02D	18	J: $\pm 5\%$	8	2.5	4.7	2.5	140
	LQP02TQ18NJ02L	18	J: $\pm 5\%$	8	2.5	4.7	2.5	140
	LQP02TQ19NH02D	19	H: $\pm 3\%$	8	2.9	4.4	2.7	140
	LQP02TQ19NH02L	19	H: $\pm 3\%$	8	2.9	4.4	2.7	140
	LQP02TQ19NJ02D	19	J: $\pm 5\%$	8	2.9	4.4	2.7	140
	LQP02TQ19NJ02L	19	J: $\pm 5\%$	8	2.9	4.4	2.7	140
	LQP02TQ20NH02D	20	H: $\pm 3\%$	8	2.9	4.4	2.7	140
	LQP02TQ20NH02L	20	H: $\pm 3\%$	8	2.9	4.4	2.7	140
	LQP02TQ20NJ02D	20	J: $\pm 5\%$	8	2.9	4.4	2.7	140
	LQP02TQ20NJ02L	20	J: $\pm 5\%$	8	2.9	4.4	2.7	140
	LQP02TQ21NH02D	21	H: $\pm 3\%$	8	3.2	4.4	2.3	120
	LQP02TQ21NH02L	21	H: $\pm 3\%$	8	3.2	4.4	2.3	120
	LQP02TQ21NJ02D	21	J: $\pm 5\%$	8	3.2	4.4	2.3	120
	LQP02TQ21NJ02L	21	J: $\pm 5\%$	8	3.2	4.4	2.3	120
	LQP02TQ22NH02D	22	H: $\pm 3\%$	8	3.2	4.4	2.3	120
	LQP02TQ22NH02L	22	H: $\pm 3\%$	8	3.2	4.4	2.3	120
	LQP02TQ22NJ02D	22	J: $\pm 5\%$	8	3.2	4.4	2.3	120
	LQP02TQ22NJ02L	22	J: $\pm 5\%$	8	3.2	4.4	2.3	120

\* Typical value is actual performance.

#### 4. Testing Conditions

Unless otherwise specified	Temperature: ordinary temperature (15°C to 35°C) Humidity: ordinary humidity [25% to 85% (RH)]
In case of doubt	Temperature: 20°C $\pm$ 2°C Humidity: 60% to 70% (RH) Atmospheric pressure: 86 kPa to 106 kPa

#### 5. Appearance and Dimensions

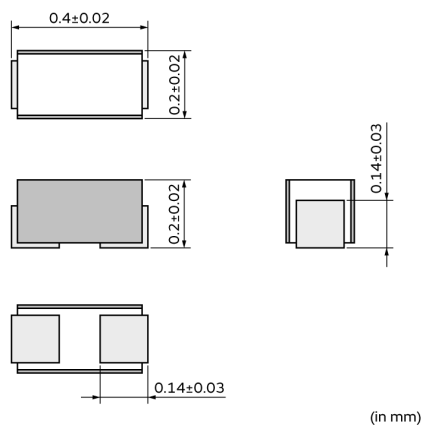

Unit mass (typical value): 0.05 mg

## 6. Marking

Side surface identification marking :blue

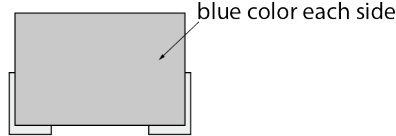

## 7. Electrical Performance

No.	Item	Specification	Test method
7.1	Inductance	Meet chapter 3 ratings.	Measuring equipment: Keysight E4991A or the equivalent Measuring frequency: 500 MHz Measuring conditions: Measurement signal level: Approx. 0 dBm Electrical length: 27.3 mm Measuring fixture: Keysight 16196D Position the chip under test as shown in the measuring example below and connect it to the electrode by applying weight. Measurement example:
7.2	Q	Meet chapter 3 ratings.	
7.3	DC resistance	Meet chapter 3 ratings.	Measuring equipment: digital multimeter
7.4	Self-resonant frequency	Meet chapter 3 ratings.	Measuring equipment: Keysight N5230A or the equivalent
7.5	Rated current	Product temperature rise: 25°C max.	Apply the rated current specified in chapter 3.

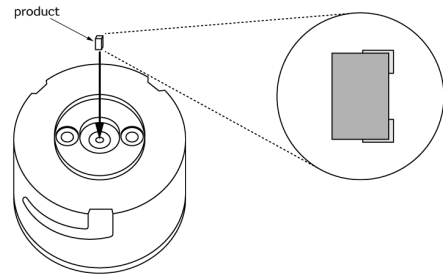

Product insertion hole:  $\phi 0.3$  mm  
 Measuring method: see "Electrical performance: Measuring method for inductance/Q" in the Appendix.

## 8. Mechanical Performance

No.	Item	Specification	Test method
8.1	Shear test	No significant mechanical damage or no sign of electrode peeling off shall be observed.	Test substrate: glass-epoxy substrate Applying force: 1 N Holding time: 5 s $\pm$ 1 s Force application direction:

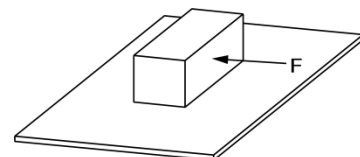

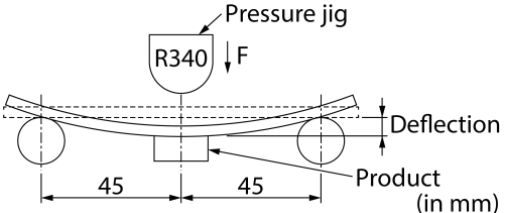
No.	Item	Specification	Test method
8.2	Bending test	No significant mechanical damage or no sign of electrode peeling off shall be observed.	<p>Test substrate: glass-epoxy substrate (100 mm × 40 mm × 0.8 mm)            Pressurizing speed: 1 mm/s            Pressure jig: R340            Deflection: 1 mm            Holding time: 30 s</p> 
8.3	Vibration	Appearance shall have no significant mechanical damage. Inductance change rate: within ±10%	<p>Oscillation frequency: 10 Hz to 2000 Hz to 10 Hz, for approx. 20 min            Total amplitude: total amplitude of 1.5 mm or acceleration amplitude of 196 m/s<sup>2</sup>, whichever is smaller            Test time: 3 directions perpendicular to each other, 2 h for each direction (6 h in total)</p>
8.4	Solderability	90% or more of the outer electrode shall be covered with new solder seamlessly.	<p>Flux: immersed in ethanol solution with a rosin content of 25(wt)% for 5 s to 10 s            Solder: Sn-3.0Ag-0.5Cu solder            Pre-heating: 150°C±10°C/60 s to 90 s            Solder temperature: 240°C±5°C            Immersion time: 3 s±1 s</p>
8.5	Resistance to soldering heat	Appearance: No significant mechanical damage shall be observed. Inductance change rate: within ±10%	<p>Flux: immersed in ethanol solution with a rosin content of 25(wt)% for 5 s to 10 s            Solder: Sn-3.0Ag-0.5Cu solder            Pre-heating: 150°C±10°C/60 s to 90 s            Solder temperature: 260°C±5°C            Immersion time: 5 s±1 s            Post-treatment: left at a room condition for 24 h±2 h</p>

## 9. Environmental Performance

The product is soldered on a glass-epoxy substrate for test.

No.	Item	Specification	Test method
9.1	Heat resistance	Appearance: No significant mechanical damage shall be observed. Inductance change rate: within ±10%	<p>Temperature: 125°C±2°C            Test time: 1000 h (+48 h, -0 h)            Post-treatment: left at a room condition for 24 h±2 h</p>
9.2	Cold resistance	Appearance: No significant mechanical damage shall be observed. Inductance change rate: within ±10%	<p>Temperature: -55°C±3°C            Test time: 1000 h (+48 h, -0 h)            Post-treatment: left at a room condition for 24 h±2 h</p>
9.3	Humidity	Appearance: No significant mechanical damage shall be observed. Inductance change rate: within ±10%	<p>Temperature: 40°C±2°C            Humidity: 90% (RH) to 95% (RH)            Test time: 1000 h (+48 h, -0 h)            Post-treatment: left at a room condition for 24 h±2 h</p>
9.4	Temperature cycle	Appearance: No significant mechanical damage shall be observed. Inductance change rate: within ±10%	<p>Single cycle conditions:            Step 1: -55°C±2°C/30 min±3 min            Step 2: ordinary temperature/10 min to 15 min            Step 3: +125°C±2°C/30 min±3 min            Step 4: ordinary temperature/10 min to 15 min            Number of testing: 10 cycles            Post-treatment: left at a room condition for 24 h±2 h</p>

### 10. Specification of Packaging

#### 10.1 Appearance and dimensions of tape

- 8 mm width/paper tape

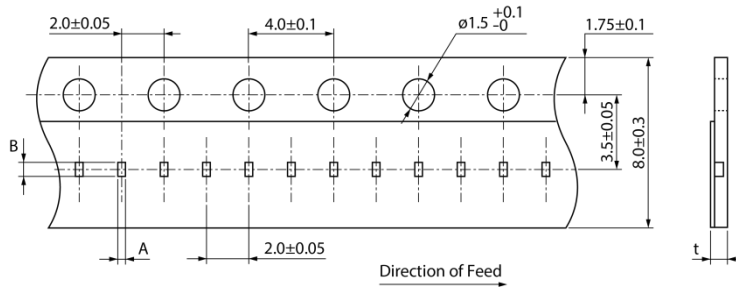

A	(0.23)
B	(0.45)
t	0.39 max.

(in mm)

- 4 mm width/plastic tape

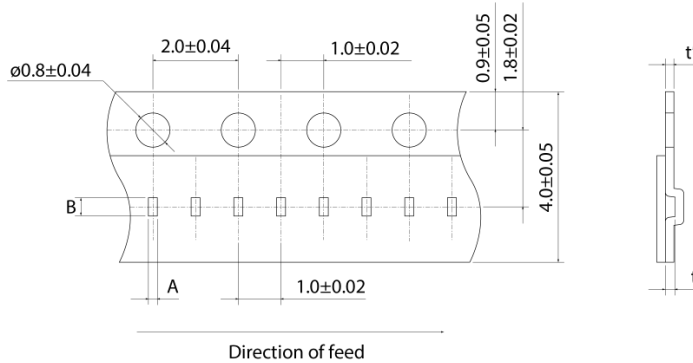

A	(0.22)
B	(0.47)
t	(0.23)
t'	0.20±0.05

(in mm)

\* The dimensions of the cavity are measured at its bottom.

■ Top view

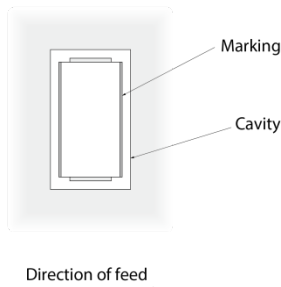

#### 10.2 Taping specifications

Packing quantity (Standard quantity)	20000 pcs/reel (carrier tape: 8 mm width, 2 mm pitch) 40000 pcs/reel (carrier tape: 4 mm width, 1 mm pitch)
Packing method	The products are placed in cavities of a carrier tape and sealed by a cover tape (top tape and bottom tape when the cavities of the carrier tape are punched type).
Feed hole position	The feed holes on the carrier tape are on the right side when the cover tape (top tape when the cavities of the carrier tape are punched type) is pulled toward the user.
Joint	The carrier tape and cover tape (top tape when the cavities of the carrier tape are punched type) are seamless.
Number of missing products	Number of missing products within 0.1% of the number per reel or 1 pc., whichever is greater, and are not continuous. The specified quantity per reel is kept.

#### 10.3 Break down force of tape

Cover tape (or top tape)	5 N min.
Bottom tape (only when the cavities of the carrier tape are punched type)	5 N min.

### 10.4 Peeling off force of tape

Speed of peeling off	300 mm/min
Peeling off force	0.1 N to 0.6 N (The lower limit is for typical value.)

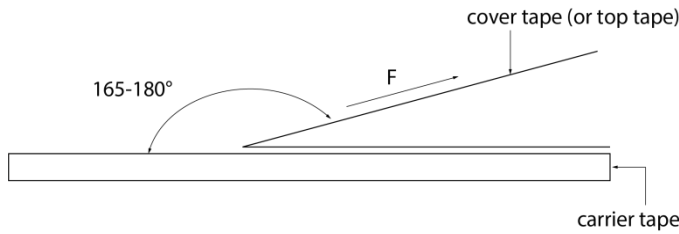

### 10.5 Dimensions of leader section, trailer section and reel

A vacant section is provided in the leader (start) section and trailer (end) section of the tape for the product. The leader section is further provided with an area consisting only of the cover tape (or top tape). (See the diagram below.)

- 8 mm width carrier tape

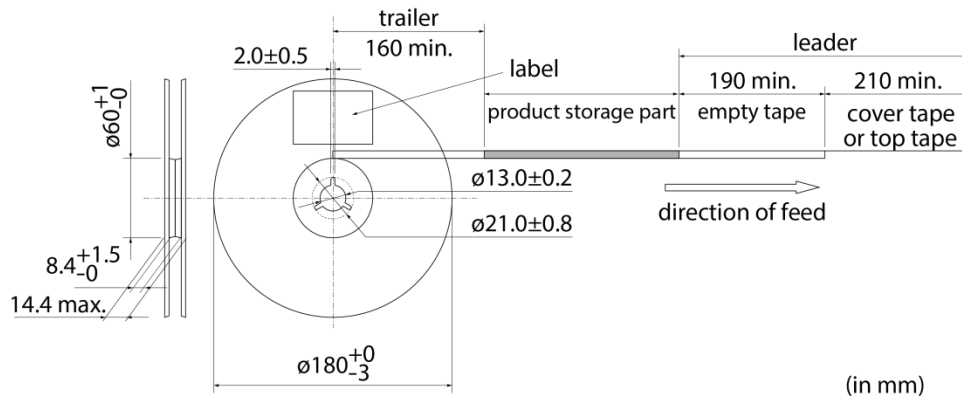

- 4 mm width carrier tape

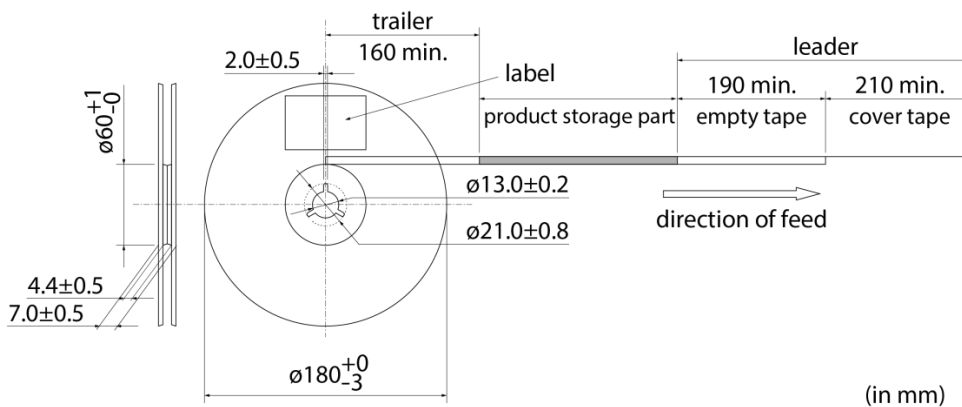

### 10.6 Marking for reel

Customer part number, Murata part number, inspection number (\*1), RoHS marking (\*2), quantity, etc.

*1 Expression of inspection No.: $\frac{\square\square}{(1)}$ $\frac{\circ\circ\circ\circ}{(2)}$ $\frac{\diamond\diamond\diamond}{(3)}$	(1) Factory code (2) Date First digit: year/last digit of year Second digit: month/Jan. to Sep. → 1 to 9, Oct. to Dec. → O, N, D Third, Fourth digit: day (3) Serial No.
*2 Expression of RoHS marking: ROHS- $\frac{Y}{(1)}$ $\frac{(\Delta)}{(2)}$	(1) RoHS regulation conformity (2) Murata classification number

### 10.7 Marking on outer box (corrugated box)

Customer name, purchasing order number, customer part number, Murata part number, RoHS marking (\*2), quantity, etc.

## 10.8 Specification of outer box

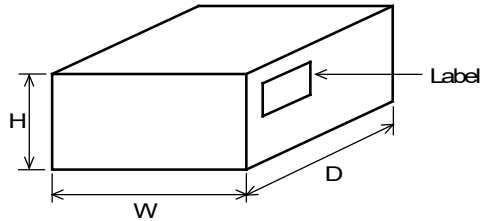

Dimensions of outer box (mm)			Tape width (mm)	Standard reel quantity in outer box(reel)
W	D	H		
186	186	93	4	10
			8	5

\* Above outer box size is typical. It depends on a quantity of an order.

## 11. ⚠Caution

### 11.1 Limitation of applications

The products listed in the reference specification (hereinafter the product(s) is called as the "Product(s)") are designed and manufactured for applications specified in the reference specification (hereinafter called as the "Specific Application"). We shall not warrant anything in connection with the Products including fitness, performance, adequateness, safety, or quality, in the case of applications listed in from (1) to (11) written at the end of this precautions, which may generally require high performance, function, quality, management of production or safety. Therefore, the Product shall be applied in compliance with the specific application.

WE DISCLAIM ANY LOSS AND DAMAGES ARISING FROM OR IN CONNECTION WITH THE PRODUCTS INCLUDING BUT NOT LIMITED TO THE CASE SUCH LOSS AND DAMAGES CAUSED BY THE UNEXPECTED ACCIDENT, IN EVENT THAT (i) THE PRODUCT IS APPLIED FOR THE PURPOSE WHICH IS NOT SPECIFIED AS THE SPECIFIC APPLICATION FOR THE PRODUCT, AND/OR (ii) THE PRODUCT IS APPLIED FOR ANY FOLLOWING APPLICATION PURPOSES FROM (1) TO (11) (EXCEPT THAT SUCH APPLICATION PURPOSE IS UNAMBIGUOUSLY SPECIFIED AS SPECIFIC APPLICATION FOR THE PRODUCT IN OUR CATALOG SPECIFICATION FORMS, DATASHEETS, OR OTHER DOCUMENTS OFFICIALLY ISSUED BY US\*).

- (1) Aircraft equipment
- (2) Aerospace equipment
- (3) Undersea equipment
- (4) Power plant control equipment
- (5) Medical equipment
- (6) Transportation equipment
- (7) Traffic control equipment
- (8) Disaster prevention/security equipment
- (9) Industrial data-processing equipment
- (10) Combustion/explosion control equipment
- (11) Equipment with complexity and/or required reliability equivalent to the applications listed in the above.

For exploring information of the Products which will be compatible with the particular purpose other than those specified in the reference specification, please contact our sales offices, distribution agents, or trading companies with which you make a deal, or via our web contact form.

Contact form: <https://www.murata.com/contactform>

\* We may design and manufacture particular Products for applications listed in (1) to (11). Provided that, in such case we shall unambiguously specify such Specific Application in the reference specification without any exception. Therefore, any other documents and/or performances, whether exist or non-exist, shall not be deemed as the evidence to imply that we accept the applications listed in (1) to (11).

### 11.2 Precautions on rating

Avoid using in exceeded the rated temperature range, rated voltage, or rated current.

Usage when the ratings are exceeded could lead to wire breakage, burning, or other serious fault.

### 11.3 Inrush current

If an inrush current (or pulse current or rush current) that significantly exceeds the rated current is applied to the product, overheating could occur, resulting in wire breakage, burning, or other serious fault.

## 12. Precautions for Use

This product is for use only with reflow soldering. It is designed to be mounted by soldering. If you want to use other mounting method, for example, using a conductive adhesive, please consult us beforehand. Also, if repeatedly subjected to temperature cycles or other thermal stress, due to the difference in the coefficient of thermal expansion with the mounting substrate, the solder (solder fillet part) in the mounting part may crack. The occurrence of cracks due to thermal stress is affected by the size of the land where mounted, the solder volume, and the heat dissipation of the mounting substrate. Carefully design it when a large change in ambient temperature is assumed.

### 12.1 Land dimensions

The following diagram shows the recommended land dimensions for reflow soldering:

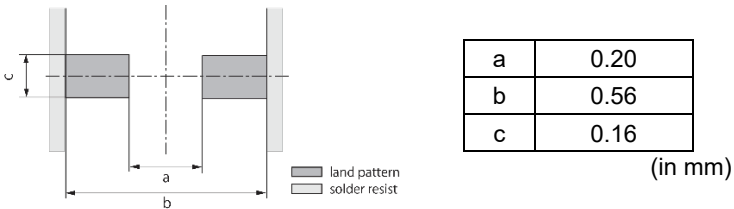

### 12.2 Flux and solder used

Flux	<ul style="list-style-type: none"> <li>Use a rosin-based flux.</li> <li>Do not use a highly acidic flux with a halide content exceeding 0.2 mass% (chlorine conversion value).</li> <li>Do not use a water-soluble flux.</li> </ul>
Solder	<ul style="list-style-type: none"> <li>Use Sn-3.0Ag-0.5Cu solder.</li> <li>Standard thickness of solder paste: 50 <math>\mu\text{m}</math> to 65 <math>\mu\text{m}</math></li> </ul>

If you want to use a flux other than the above, please consult our technical department.

### 12.3 Soldering conditions (reflow)

- Pre-heating should be in such a way that the temperature difference between solder and product surface is limited to 150°C max. Cooling into solvent after soldering also should be in such a way that the temperature difference is limited to 100°C max. Insufficient pre-heating may cause cracks on the product, resulting in the deterioration of product quality.
- Standard soldering profile and the limit soldering profile is as follows. The excessive limit soldering conditions may cause leaching of the electrode and/or resulting in the deterioration of product quality.

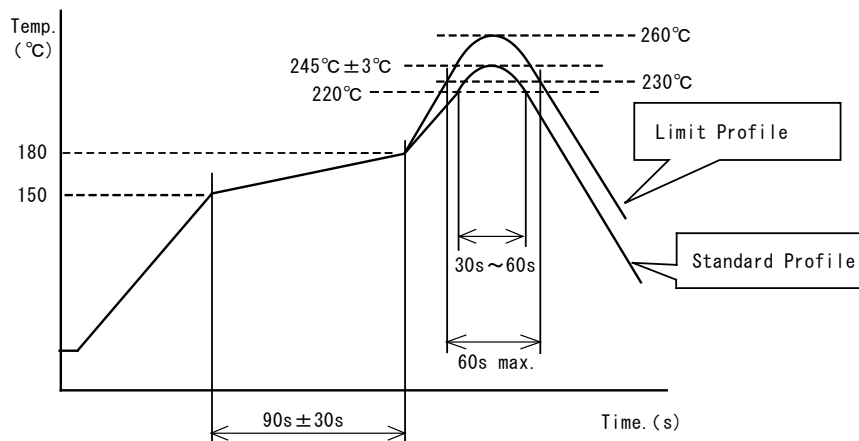

	Standard profile	Limit profile
Pre-heating	150°C to 180°C/90 s $\pm$ 30 s	150°C to 180°C/90 s $\pm$ 30 s
Heating	Above 220°C/30 s to 60 s	Above 230°C/60 s max.
Peak temperature	245°C $\pm$ 3°C	260°C/10 s
Number of reflow cycles	2 times	2 times

### 12.4 Reworking with soldering iron

Do not perform reworking with a soldering iron on this product.

**12.5 Solder volume**

Solder shall be used not to increase the volume too much.



$1/3 T \leq t \leq 1/2 T$   
 T: thickness of product

An increased solder volume increases mechanical stress on the product. Exceeding solder volume may cause the failure of mechanical or electrical performance.

**12.6 Product's location**

The following shall be considered when designing and laying out PCBs.

(1) PCB shall be designed so that products are not subject to mechanical stress due to warping the board.

[Products direction]

Products shall be located in the sideways direction (length:  $a < b$ ) to the mechanical stress.

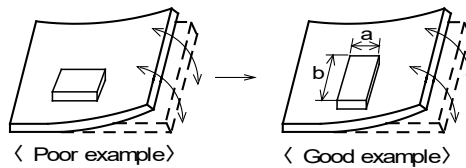

(2) Components location on PCB separation

It is effective to implement the following measures, to reduce stress in separating the board.

It is best to implement all of the following three measures; however, implement as many measures as possible to reduce stress.

Contents of measures	Stress level
(1) Turn the mounting direction of the component parallel to the board separation surface.	$A > D^{*1}$
(2) Add slits in the board separation part.	$A > B$
(3) Keep the mounting position of the component away from the board separation surface.	$A > C$
*1 $A > D$ is valid when stress is added vertically to the perforation as with hand separation. If a cutting disc is used, stress will be diagonal to the PCB, therefore $A > D$ is invalid.	

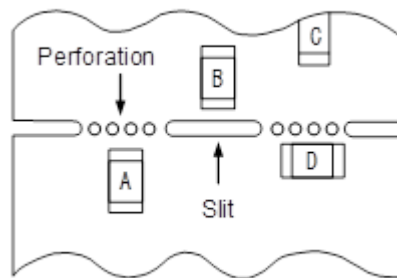

(3) Mounting components near screw holes

When a component is mounted near a screw hole, it may be affected by the board deflection that occurs during the tightening of the screw.

Mount the component in a position as far away from the screw holes as possible.

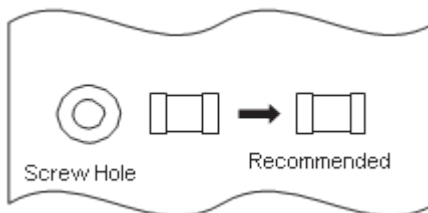



## 12.7 Handling of substrate

- (1) The stress applied to the chip varies depending on the material and construction of the mounted substrate. If the coefficients of thermal expansion for the substrate and chip vary significantly, the difference in thermal expansion and shrinkage could cause cracks to form in the chip. We assume that the products are mounted on glass-epoxy substrate. Assessment has not been conducted on substrates where the coefficient of thermal expansion varies significantly from glass-epoxy substrates. If mounting on these substrates, be sure to conduct full assessments before use.
- (2) After mounting products on a substrate, do not apply any stress to the product caused by bending or twisting to the substrate when cropping the substrate, inserting and removing a connector from the substrate or tightening screw to the substrate. Excessive mechanical stress may cause cracking in the product. Also, if mounting on flexible substrates, excessive mechanical stress could be applied to the chip by even slight bending or twisting when handling this substrate, and so please conduct full assessments before use.

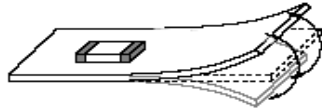

Bending

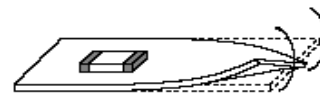

Twisting

## 12.8 Cleaning

Excessive ultrasonic oscillation during cleaning can cause the PCBs to resonate, resulting in cracked chips or broken solder joints. Before starting your production process, test your cleaning equipment / process to insure it does not degrade this product.

## 12.9 Storage and transportation

Storage period	Use the product within 12 months after delivery. If you do not use the product for more than 12 months, check solderability before using it.
Storage conditions	<ul style="list-style-type: none"> <li>The products shall be stored in a room not subject to rapid changes in temperature and humidity. The recommended temperature range is <math>-10^{\circ}\text{C}</math> to <math>+40^{\circ}\text{C}</math>. The recommended relative humidity range is 15% to 85%. Keeping the product in corrosive gases, such as sulfur, chlorine gas or acid may cause the poor solderability.</li> <li>Do not place the products directly on the floor; they should be placed on a palette so that they are not affected by humidity or dust.</li> <li>Avoid keeping the products in a place exposed to direct sunlight, heat or vibration.</li> <li>Do not keep products in bulk packaging. Bulk storage could result in collisions between the products or between the products and other parts, resulting in chipping or wire breakage.</li> <li>Avoid storing the product by itself bare (i.e. exposed directly to air).</li> </ul>
Transportation	Excessive vibration and impact reduces the reliability of the products. Exercise caution when handling the products.

## 12.10 Resin coating (including moisture-proof coating)

When the product is coated/molded with resin, its electrical characteristics may change. A wire breakage issue may occur by mechanical stress caused by the resin, amount/cured shape of resin, or operating condition etc. Some resins contain impurities or hydrolyzable chlorine, which could result in corrosion of the conducting materials, leading to wire breakage. So, please pay your careful attention when you select resin in case of coating/molding the products with the resin. Prior to use the coating resin, please make sure no reliability issue is observed by evaluating products mounted on your board.

## 12.11 Mounting conditions

Check the mounting condition before using. Using mounting conditions (nozzles, equipment conditions, etc.) that are not suitable for products may lead to pick up errors, misalignment, or damage to the product.

## 12.12 Operating environment

- Do not use this product under the following environmental conditions as it may cause deterioration of product quality.
- In the corrodible atmosphere such as acidic gases, alkaline gases, chlorine, sulfur gases, organic gases and etc. (the sea breeze,  $\text{Cl}_2$ ,  $\text{H}_2\text{S}$ ,  $\text{NH}_3$ ,  $\text{SO}_2$ ,  $\text{NO}_2$ , etc)
  - In the atmosphere where liquid such as organic solvent, may splash on the products.
  - In the atmosphere where the temperature/humidity changes rapidly and it is easy to dew.

**12.13 Mounting density**

If this product is placed near heat-generating products, be sure to implement sufficient heat-dissipating measures.

If this product is subjected to a significant amount of heat from other products, this could adversely affect product quality, resulting in a circuit malfunction or failure of the mounted section. Also, be sure that the product is used in a manner so that the heat that the product is subjected to from other products does not exceed the upper limit of the rated operating temperature for the product.

**13.  Note**

- (1) Please make sure that your product has been evaluated in view of your specifications with our product being mounted to your product.
- (2) You are requested not to use our product deviating from the reference specifications.
- (3) The contents of this reference specification are subject to change without advance notice. Please approve our product specifications or transact the approval sheet for product specifications before ordering.

**Appendix**

Electrical performance: Measuring method for inductance/Q (Q measurement is applicable only when the Q value is included in the rating table.)

Perform measurement using the method described below. (Perform correction for the error deriving from the measuring terminal.)

(1) Residual elements and stray elements of the measuring terminal can be expressed by the F parameter for the 2-pole terminal as shown in the figure below.

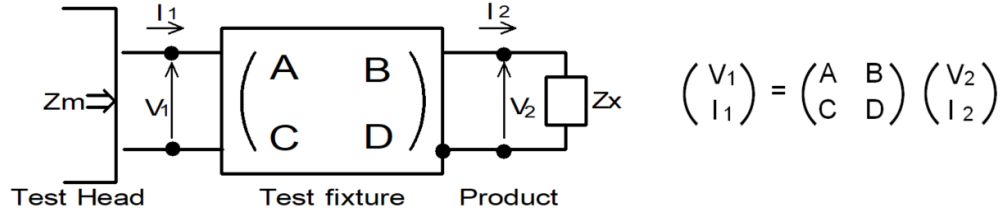

(2) The product's impedance value (Zx) and measured impedance value (Zm) can be expressed as shown below, by using the respective current and voltage for input/output.

$$Z_m = \frac{V_1}{I_1} \quad Z_x = \frac{V_2}{I_2}$$

(3) Thus, the relationship between the product's impedance value (Zx) and measured impedance value (Zm) is as follows.

$Z_x = \alpha \frac{Z_m - \beta}{1 - Z_m \Gamma}$	<p>Here,</p> <p><math>\alpha = D/A = 1</math></p> <p><math>\beta = B/D = Z_{sm} - (1 - Y_{om} Z_{sm}) Z_{ss}</math></p> <p><math>\Gamma = C/A = Y_{om}</math></p> <p><math>Z_{sm}</math>: measured impedance of short chip</p> <p><math>Z_{ss}</math>: residual impedance of short chip (0.110 nH)</p> <p><math>Y_{om}</math>: measured admittance when measuring terminal is open</p>
---	--

(4) Calculate inductance Lx and Qx using the equations shown below.

$L_x = \frac{\text{Im}(Z_x)}{2\pi f}$	<p><math>L_x</math>: inductance of chip coil</p> <p><math>Q_x</math>: Q of chip coil</p> <p><math>f</math>: measuring frequency</p>
$Q_x = \frac{\text{Im}(Z_x)}{\text{Re}(Z_x)}$	

## OUR CERTIFICATE

DiGi provide top-quality products and perfect service for customer worldwide through standardization, technological innovation and continuous improvement. DiGi through third-party certification, we stricly control the quality of products and services. Welcome your RFQ to

Email: [Info@DiGi-Electronics.com](mailto:Info@DiGi-Electronics.com)



Tel: +00 852-30501935

RFQ Email: [Info@DiGi-Electronics.com](mailto:Info@DiGi-Electronics.com)

DiGi is a global authorized distributor of electronic components.