

LQP03TG2N2B02D Datasheet

www.digi-electronics.com

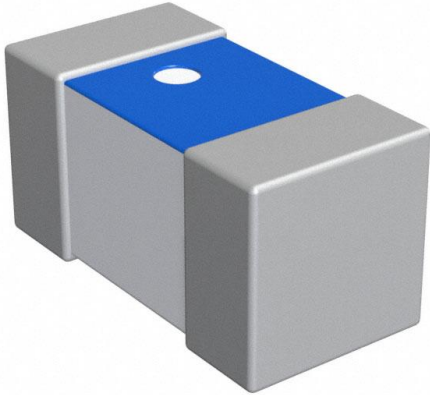

<https://www.DiGi-Electronics.com>

DiGi Electronics Part Number	LQP03TG2N2B02D-DG
Manufacturer	Murata Electronics
Manufacturer Product Number	LQP03TG2N2B02D
Description	FIXED IND 2.2NH 450MA 250MOHM SM
Detailed Description	2.2 nH Unshielded Thick Film Inductor 450 mA 250m Ohm Max 0201 (0603 Metric)



Tel: +00 852-30501935

RFQ Email: Info@DiGi-Electronics.com

DiGi is a global authorized distributor of electronic components.

Purchase and inquiry

Manufacturer Product Number:

LQP03TG2N2B02D

Series:

LQP03

Type:

Thick Film

Inductance:

2.2 nH

Current Rating (Amps):

450 mA

Shielding:

Unshielded

Q @ Freq:

13 @ 500MHz

Ratings:

-

Inductance Frequency - Test:

500 MHz

Mounting Type:

Surface Mount

Supplier Device Package:

0201 (0603 Metric)

Height - Seated (Max):

0.013" (0.33mm)

Manufacturer:

Murata Electronics

Product Status:

Active

Material - Core:

Non-Magnetic

Tolerance:

±0.1nH

Current - Saturation (Isat):

-

DC Resistance (DCR):

250mOhm Max

Frequency - Self Resonant:

12GHz

Operating Temperature:

-55°C ~ 125°C

Features:

-

Package / Case:

0201 (0603 Metric)

Size / Dimension:

0.024" L x 0.012" W (0.60mm x 0.30mm)

Base Product Number:

LQP03TG

Environmental & Export classification

RoHS Status:

ROHS3 Compliant

REACH Status:

REACH Unaffected

HTSUS:

8504.50.8000

Moisture Sensitivity Level (MSL):

1 (Unlimited)

ECCN:

EAR99

CHIP COIL (CHIP INDUCTOR) for Consumer equipment & Industrial equipment LQP03TG□□□□02□ REFERENCE SPECIFICATION

1. Scope

This reference specification applies to chip coil (chip inductor) LQP03TG_02 series.

1.1 Specific applications:

- Power equipment: Products that can be used in power equipment such as renewable energy equipment, energy storage equipment and EV charging equipment and whose functions are not directly related to the protection of human life and property.
- Industrial equipment: Products that can be used in industrial equipment such as base stations, manufacturing equipment, industrial robotics equipment, and measurement equipment, and whose functions do not directly relate to the protection of human life and property.
- Medical equipment (GHTF Class C) *Except for implant/surgery/auto injector: Products that can be used for medical equipment of Class C of the international classification class GHTF and whose malfunction is considered to pose a relatively high risk to the human body.
- Medical equipment (GHTF Class A and B): Products that can be used for medical equipment regulated by Class A and Class B of the international classification class GHTF and whose functions do not directly relate to the protection of human life and property.
- Consumer equipment: Products that can be used in consumer equipment such as home appliances, audio/visual equipment, communication equipment, information equipment, office equipment, and household robotics, and whose functions are not directly related to the protection of human life and property.

1.2 Unsuitable application:

Applications listed in "Limitation of applications" in this reference specification.

2. Part Numbering

(Ex.) LQ	P	03	T	G	0N1	B	0	2	D
Product ID	Structure	Dimension (L × W)	Application and characteristic	Category	Inductance	Tolerance	Performance	Electrode specification	Packaging
									D: taping *B: bulk

*B: Bulk packing is also available (taping condition: however, products without reels are put in plastic bags).

3. Part Number and Rating

Operating temperature range	-55°C to +125°C
Storage temperature range	-55°C to +125°C

Customer Part number	Murata Part number	Inductance		Q (Min.)	DC resistance (Ω max.)	Self-resonant frequency (MHz)		Rated current (mA)
		Nominal value (nH)	Tolerance			Lower limit	*Typical value	
	LQP03TG0N1B02D	0.1	B: ±0.1 nH	-	0.07	20000	20000	850
	LQP03TG0N2B02D	0.2	B: ±0.1 nH	-	0.08	20000	20000	850
	LQP03TG0N2C02D	0.2	C: ±0.2 nH	-	0.08	20000	20000	850
	LQP03TG0N3B02D	0.3	B: ±0.1 nH	-	0.08	18000	20000	850
	LQP03TG0N3C02D	0.3	C: ±0.2 nH	-	0.08	18000	20000	850
	LQP03TG0N4B02D	0.4	B: ±0.1 nH	-	0.08	18000	20000	850
	LQP03TG0N4C02D	0.4	C: ±0.2 nH	-	0.08	18000	20000	850
	LQP03TG0N5B02D	0.5	B: ±0.1 nH	11	0.08	18000	20000	850
	LQP03TG0N5C02D	0.5	C: ±0.2 nH	11	0.08	18000	20000	850
	LQP03TG0N6B02D	0.6	B: ±0.1 nH	11	0.08	18000	20000	850
	LQP03TG0N6C02D	0.6	C: ±0.2 nH	11	0.08	18000	20000	850
	LQP03TG0N7B02D	0.7	B: ±0.1 nH	12	0.10	18000	20000	750
	LQP03TG0N7C02D	0.7	C: ±0.2 nH	12	0.10	18000	20000	750
	LQP03TG0N8B02D	0.8	B: ±0.1 nH	12	0.10	18000	20000	750

Customer Part number	Murata Part number	Inductance		Q (Min.)	DC resistance (Ω max.)	Self-resonant frequency (MHz)		Rated current (mA)
		Nominal value (nH)	Tolerance			Lower limit	*Typical value	
	LQP03TG0N8C02D	0.8	C: ± 0.2 nH	12	0.10	18000	20000	750
	LQP03TG0N9B02D	0.9	B: ± 0.1 nH	12	0.12	18000	20000	700
	LQP03TG0N9C02D	0.9	C: ± 0.2 nH	12	0.12	18000	20000	700
	LQP03TG1N0B02D	1.0	B: ± 0.1 nH	12	0.15	17000	20000	600
	LQP03TG1N0C02D	1.0	C: ± 0.2 nH	12	0.15	17000	20000	600
	LQP03TG1N1B02D	1.1	B: ± 0.1 nH	12	0.15	17000	20000	600
	LQP03TG1N1C02D	1.1	C: ± 0.2 nH	12	0.15	17000	20000	600
	LQP03TG1N2B02D	1.2	B: ± 0.1 nH	13	0.15	15000	18100	600
	LQP03TG1N2C02D	1.2	C: ± 0.2 nH	13	0.15	15000	18100	600
	LQP03TG1N3B02D	1.3	B: ± 0.1 nH	13	0.15	15000	18200	600
	LQP03TG1N3C02D	1.3	C: ± 0.2 nH	13	0.15	15000	18200	600
	LQP03TG1N4B02D	1.4	B: ± 0.1 nH	13	0.15	14000	17800	600
	LQP03TG1N4C02D	1.4	C: ± 0.2 nH	13	0.15	14000	17800	600
	LQP03TG1N5B02D	1.5	B: ± 0.1 nH	13	0.15	13500	16400	600
	LQP03TG1N5C02D	1.5	C: ± 0.2 nH	13	0.15	13500	16400	600
	LQP03TG1N6B02D	1.6	B: ± 0.1 nH	13	0.15	13000	16100	600
	LQP03TG1N6C02D	1.6	C: ± 0.2 nH	13	0.15	13000	16100	600
	LQP03TG1N7B02D	1.7	B: ± 0.1 nH	13	0.20	12500	16400	500
	LQP03TG1N7C02D	1.7	C: ± 0.2 nH	13	0.20	12500	16400	500
	LQP03TG1N8B02D	1.8	B: ± 0.1 nH	13	0.20	12500	15000	500
	LQP03TG1N8C02D	1.8	C: ± 0.2 nH	13	0.20	12500	15000	500
	LQP03TG1N9B02D	1.9	B: ± 0.1 nH	13	0.25	12500	15900	450
	LQP03TG1N9C02D	1.9	C: ± 0.2 nH	13	0.25	12500	15900	450
	LQP03TG2N0B02D	2.0	B: ± 0.1 nH	13	0.25	12500	14800	450
	LQP03TG2N0C02D	2.0	C: ± 0.2 nH	13	0.25	12500	14800	450
	LQP03TG2N1B02D	2.1	B: ± 0.1 nH	13	0.25	12000	14800	450
	LQP03TG2N1C02D	2.1	C: ± 0.2 nH	13	0.25	12000	14800	450
	LQP03TG2N2B02D	2.2	B: ± 0.1 nH	13	0.25	12000	14300	450
	LQP03TG2N2C02D	2.2	C: ± 0.2 nH	13	0.25	12000	14300	450
	LQP03TG2N3B02D	2.3	B: ± 0.1 nH	13	0.25	11500	14100	450
	LQP03TG2N3C02D	2.3	C: ± 0.2 nH	13	0.25	11500	14100	450
	LQP03TG2N4B02D	2.4	B: ± 0.1 nH	13	0.25	11000	13700	450
	LQP03TG2N4C02D	2.4	C: ± 0.2 nH	13	0.25	11000	13700	450
	LQP03TG2N5B02D	2.5	B: ± 0.1 nH	13	0.25	11000	13800	450
	LQP03TG2N5C02D	2.5	C: ± 0.2 nH	13	0.25	11000	13800	450
	LQP03TG2N6B02D	2.6	B: ± 0.1 nH	13	0.25	11000	13900	450
	LQP03TG2N6C02D	2.6	C: ± 0.2 nH	13	0.25	11000	13900	450
	LQP03TG2N7B02D	2.7	B: ± 0.1 nH	13	0.25	11000	13100	450
	LQP03TG2N7C02D	2.7	C: ± 0.2 nH	13	0.25	11000	13100	450
	LQP03TG2N8B02D	2.8	B: ± 0.1 nH	13	0.25	9500	12200	450
	LQP03TG2N8C02D	2.8	C: ± 0.2 nH	13	0.25	9500	12200	450
	LQP03TG2N9B02D	2.9	B: ± 0.1 nH	13	0.25	9500	12200	450
	LQP03TG2N9C02D	2.9	C: ± 0.2 nH	13	0.25	9500	12200	450
	LQP03TG3N0B02D	3.0	B: ± 0.1 nH	13	0.25	9500	11500	450

Customer Part number	Murata Part number	Inductance		Q (Min.)	DC resistance (Ω max.)	Self-resonant frequency (MHz)		Rated current (mA)
		Nominal value (nH)	Tolerance			Lower limit	*Typical value	
	LQP03TG3N0C02D	3.0	C: ± 0.2 nH	13	0.25	9500	11500	450
	LQP03TG3N1B02D	3.1	B: ± 0.1 nH	13	0.32	9500	11800	400
	LQP03TG3N1C02D	3.1	C: ± 0.2 nH	13	0.32	9500	11800	400
	LQP03TG3N2B02D	3.2	B: ± 0.1 nH	13	0.32	9500	11600	400
	LQP03TG3N2C02D	3.2	C: ± 0.2 nH	13	0.32	9500	11600	400
	LQP03TG3N3B02D	3.3	B: ± 0.1 nH	13	0.32	9500	11200	400
	LQP03TG3N3C02D	3.3	C: ± 0.2 nH	13	0.32	9500	11200	400
	LQP03TG3N4B02D	3.4	B: ± 0.1 nH	13	0.35	8000	10300	350
	LQP03TG3N4C02D	3.4	C: ± 0.2 nH	13	0.35	8000	10300	350
	LQP03TG3N5B02D	3.5	B: ± 0.1 nH	13	0.35	8000	10000	350
	LQP03TG3N5C02D	3.5	C: ± 0.2 nH	13	0.35	8000	10000	350
	LQP03TG3N6B02D	3.6	B: ± 0.1 nH	13	0.35	8000	9400	350
	LQP03TG3N6C02D	3.6	C: ± 0.2 nH	13	0.35	8000	9400	350
	LQP03TG3N7B02D	3.7	B: ± 0.1 nH	13	0.35	7000	8600	350
	LQP03TG3N7C02D	3.7	C: ± 0.2 nH	13	0.35	7000	8600	350
	LQP03TG3N8B02D	3.8	B: ± 0.1 nH	13	0.35	7000	8600	350
	LQP03TG3N8C02D	3.8	C: ± 0.2 nH	13	0.35	7000	8600	350
	LQP03TG3N9B02D	3.9	B: ± 0.1 nH	13	0.35	6500	8100	350
	LQP03TG3N9C02D	3.9	C: ± 0.2 nH	13	0.35	6500	8100	350
	LQP03TG4N3H02D	4.3	H: $\pm 3\%$	13	0.58	6500	8000	300
	LQP03TG4N3J02D	4.3	J: $\pm 5\%$	13	0.58	6500	8000	300
	LQP03TG4N7H02D	4.7	H: $\pm 3\%$	12	0.72	6500	7800	250
	LQP03TG4N7J02D	4.7	J: $\pm 5\%$	12	0.72	6500	7800	250
	LQP03TG5N1H02D	5.1	H: $\pm 3\%$	12	0.72	6500	7800	250
	LQP03TG5N1J02D	5.1	J: $\pm 5\%$	12	0.72	6500	7800	250
	LQP03TG5N6H02D	5.6	H: $\pm 3\%$	12	0.88	6000	7500	250
	LQP03TG5N6J02D	5.6	J: $\pm 5\%$	12	0.88	6000	7500	250
	LQP03TG6N2H02D	6.2	H: $\pm 3\%$	12	1.15	6000	7400	200
	LQP03TG6N2J02D	6.2	J: $\pm 5\%$	12	1.15	6000	7400	200
	LQP03TG6N8H02D	6.8	H: $\pm 3\%$	12	1.15	5400	6300	200
	LQP03TG6N8J02D	6.8	J: $\pm 5\%$	12	1.15	5400	6300	200
	LQP03TG7N5H02D	7.5	H: $\pm 3\%$	12	1.22	4800	5600	200
	LQP03TG7N5J02D	7.5	J: $\pm 5\%$	12	1.22	4800	5600	200
	LQP03TG8N2H02D	8.2	H: $\pm 3\%$	12	1.40	4800	6200	200
	LQP03TG8N2J02D	8.2	J: $\pm 5\%$	12	1.40	4800	6200	200
	LQP03TG9N1H02D	9.1	H: $\pm 3\%$	11	1.40	4500	5200	200
	LQP03TG9N1J02D	9.1	J: $\pm 5\%$	11	1.40	4500	5200	200
	LQP03TG10NH02D	10	H: $\pm 3\%$	11	1.52	4500	5200	190
	LQP03TG10NJ02D	10	J: $\pm 5\%$	11	1.52	4500	5200	190
	LQP03TG11NH02D	11	H: $\pm 3\%$	11	1.65	4100	4700	180
	LQP03TG11NJ02D	11	J: $\pm 5\%$	11	1.65	4100	4700	180
	LQP03TG12NH02D	12	H: $\pm 3\%$	11	1.78	3700	4400	180
	LQP03TG12NJ02D	12	J: $\pm 5\%$	11	1.78	3700	4400	180
	LQP03TG13NH02D	13	H: $\pm 3\%$	11	1.82	3400	3800	170

Customer Part number	Murata Part number	Inductance		Q (Min.)	DC resistance (Ω max.)	Self-resonant frequency (MHz)		Rated current (mA)
		Nominal value (nH)	Tolerance			Lower limit	*Typical value	
	LQP03TG13NJ02D	13	J: $\pm 5\%$	11	1.82	3400	3800	170
	LQP03TG15NH02D	15	H: $\pm 3\%$	11	1.90	3100	3600	170
	LQP03TG15NJ02D	15	J: $\pm 5\%$	11	1.90	3100	3600	170
	LQP03TG16NH02D	16	H: $\pm 3\%$	11	2.03	2900	3300	160
	LQP03TG16NJ02D	16	J: $\pm 5\%$	11	2.03	2900	3300	160
	LQP03TG18NH02D	18	H: $\pm 3\%$	11	2.28	2800	3200	160
	LQP03TG18NJ02D	18	J: $\pm 5\%$	11	2.28	2800	3200	160
	LQP03TG20NH02D	20	H: $\pm 3\%$	9	2.57	2600	2900	140
	LQP03TG20NJ02D	20	J: $\pm 5\%$	9	2.57	2600	2900	140
	LQP03TG22NH02D	22	H: $\pm 3\%$	9	2.85	2500	2900	140
	LQP03TG22NJ02D	22	J: $\pm 5\%$	9	2.85	2500	2900	140
	LQP03TG24NH02D	24	H: $\pm 3\%$	7	3.17	2000	2400	120
	LQP03TG24NJ02D	24	J: $\pm 5\%$	7	3.17	2000	2400	120
	LQP03TG27NH02D	27	H: $\pm 3\%$	7	3.65	1700	2200	120
	LQP03TG27NJ02D	27	J: $\pm 5\%$	7	3.65	1700	2200	120
	LQP03TG33NJ02D	33	J: $\pm 5\%$	7	4.25	1600	2000	110
	LQP03TG39NJ02D	39	J: $\pm 5\%$	7	4.60	1500	2000	110
	LQP03TG47NJ02D	47	J: $\pm 5\%$	7	5.20	1300	1700	100
	LQP03TG56NJ02D	56	J: $\pm 5\%$	7	5.60	1200	1500	100
	LQP03TG68NJ02D	68	J: $\pm 5\%$	6	6.25	1100	1400	90
	LQP03TG82NJ02D	82	J: $\pm 5\%$	6	7.15	1000	1300	90
	LQP03TGR10J02D	100	J: $\pm 5\%$	6	8.05	900	1200	80
	LQP03TGR12J02D	120	J: $\pm 5\%$	6	8.75	800	1000	80

* Typical value is actual performance.

4. Testing Conditions

Unless otherwise specified	Temperature: ordinary temperature (15°C to 35°C) Humidity: ordinary humidity [25% to 85% (RH)]
In case of doubt	Temperature: 20°C \pm 2°C Humidity: 60% to 70% (RH) Atmospheric pressure: 86 kPa to 106 kPa

5. Appearance and Dimensions

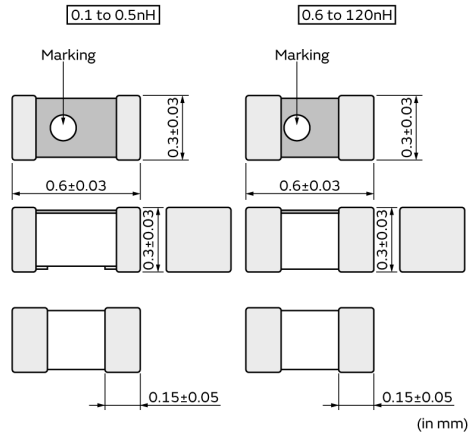

Unit mass (typical value): 0.2 mg

6. Marking

Direction identification marking: white

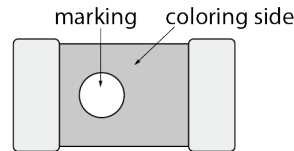

7. Electrical Performance

No.	Item	Specification	Test method				
7.1	Inductance	Meet chapter 3 ratings.	Measuring equipment: Keysight E4991A or the equivalent Measuring frequency: <table border="1" style="margin-left: 20px;"> <tr> <td>500 MHz</td> <td>0.1 nH to 27 nH</td> </tr> <tr> <td>300 MHz</td> <td>33 nH to 120 nH</td> </tr> </table> Measuring conditions: Measurement signal level: Approx. 0 dBm Measurement terminal distance: 0.2 mm Electrical length: 10 mm Measuring fixture: Keysight 16197A Position the chip coil under test as shown in the measuring example below and connect it to the electrode by applying weight. Measurement example: <div style="text-align: center; margin-top: 10px;"> </div> Measuring method: see "Electrical performance: Measuring method for inductance/Q" in the Appendix.	500 MHz	0.1 nH to 27 nH	300 MHz	33 nH to 120 nH
500 MHz	0.1 nH to 27 nH						
300 MHz	33 nH to 120 nH						
7.2	Q	Meet chapter 3 ratings.					
7.3	DC resistance	Meet chapter 3 ratings.	Measuring equipment: digital multimeter				
7.4	Self-resonant frequency	Meet chapter 3 ratings.	Measuring equipment: Keysight 8753C or the equivalent				

No.	Item	Specification	Test method
7.5	Rated current	Product temperature rise: 25°C max.	Apply the rated current specified in chapter 3.

8. Mechanical Performance

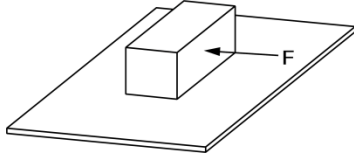
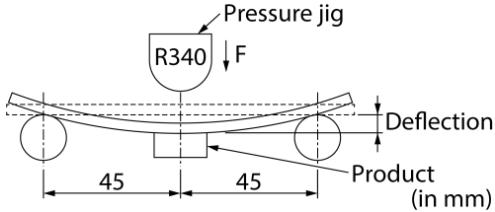
No.	Item	Specification	Test method
8.1	Shear test	No significant mechanical damage or no sign of electrode peeling off shall be observed.	Test substrate: glass-epoxy substrate Applying force: 2 N Holding time: 5 s \pm 1 s Force application direction: 
8.2	Bending test	No significant mechanical damage or no sign of electrode peeling off shall be observed.	Test substrate: glass-epoxy substrate (100 mm \times 40 mm \times 0.8 mm) Pressurizing speed: 1 mm/s Pressure jig: R340 Deflection: 1 mm Holding time: 30 s 
8.3	Vibration	Appearance shall have no significant mechanical damage. Inductance change rate: within \pm 10%	Oscillation frequency: 10 Hz to 2000 Hz to 10 Hz, for approx. 20 min Total amplitude: total amplitude of 1.5 mm or acceleration amplitude of 196 m/s ² , whichever is smaller Test time: 3 directions perpendicular to each other, 2 h for each direction (6 h in total)
8.4	Solderability	90% or more of the outer electrode shall be covered with new solder seamlessly.	Flux: immersed in ethanol solution with a rosin content of 25(wt)% for 5 s to 10 s Solder: Sn-3.0Ag-0.5Cu solder Pre-heating: 150°C \pm 10°C/60 s to 90 s Solder temperature: 240°C \pm 5°C Immersion time: 3 s \pm 1 s
8.5	Resistance to soldering heat	Appearance: No significant mechanical damage shall be observed. Inductance change rate: within \pm 10%	Flux: immersed in ethanol solution with a rosin content of 25(wt)% for 5 s to 10 s Solder: Sn-3.0Ag-0.5Cu solder Pre-heating: 150°C \pm 10°C/60 s to 90 s Solder temperature: 260°C \pm 5°C Immersion time: 5 s \pm 1 s Post-treatment: left at a room condition for 24 h \pm 2 h

9. Environmental Performance

The product is soldered on a glass-epoxy substrate for test.

No.	Item	Specification	Test method
9.1	Heat resistance	Appearance: No significant mechanical damage shall be observed. Inductance change rate: within \pm 10%	Temperature: 125°C \pm 2°C Test time: 1000 h (+48 h, -0 h) Post-treatment: left at a room condition for 24 h \pm 2 h
9.2	Cold resistance	Appearance: No significant mechanical damage shall be observed. Inductance change rate: within \pm 10%	Temperature: -55°C \pm 3°C Test time: 1000 h (+48 h, -0 h) Post-treatment: left at a room condition for 24 h \pm 2 h
9.3	Humidity	Appearance: No significant mechanical damage shall be observed. Inductance change rate: within \pm 10%	Temperature: 40°C \pm 2°C Humidity: 90% (RH) to 95% (RH) Test time: 1000 h (+48 h, -0 h) Post-treatment: left at a room condition for 24 h \pm 2 h

No.	Item	Specification	Test method
9.4	Temperature cycle	Appearance: No significant mechanical damage shall be observed. Inductance change rate: within $\pm 10\%$	Single cycle conditions: Step 1: $-55^{\circ}\text{C} \pm 2^{\circ}\text{C} / 30 \text{ min} \pm 3 \text{ min}$ Step 2: ordinary temperature / 10 min to 15 min Step 3: $+125^{\circ}\text{C} \pm 2^{\circ}\text{C} / 30 \text{ min} \pm 3 \text{ min}$ Step 4: ordinary temperature / 10 min to 15 min Number of testing: 10 cycles Post-treatment: left at a room condition for 24 h $\pm 2 \text{ h}$

10. Specification of Packaging

10.1 Appearance and dimensions of tape (8 mm width/paper tape)

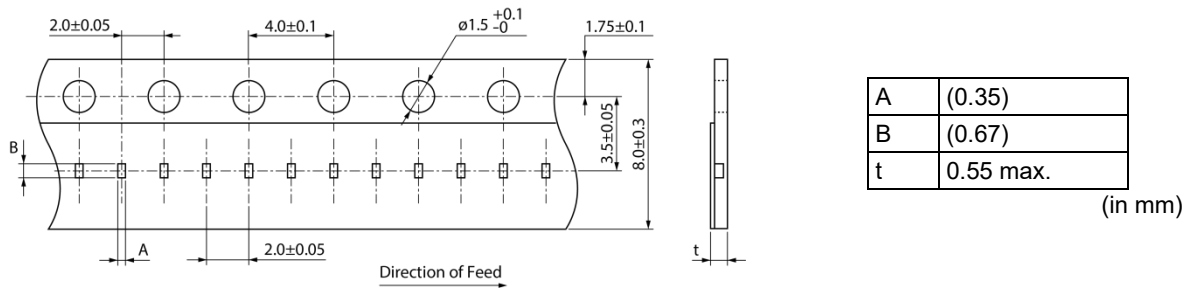

■ Top view

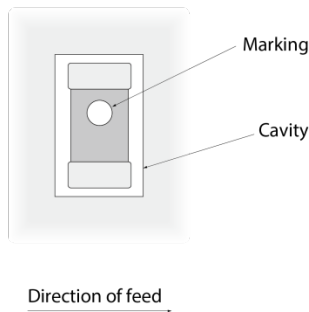

10.2 Taping specifications

Packing quantity (Standard quantity)	15000 pcs/reel
Packing method	The products are placed in cavities of a carrier tape and sealed by a cover tape (top tape and bottom tape when the cavities of the carrier tape are punched type).
Feed hole position	The feed holes on the carrier tape are on the right side when the cover tape (top tape when the cavities of the carrier tape are punched type) is pulled toward the user.
Joint	The carrier tape and cover tape (top tape when the cavities of the carrier tape are punched type) are seamless.
Number of missing products	Number of missing products within 0.1% of the number per reel or 1 pc., whichever is greater, and are not continuous. The specified quantity per reel is kept.

10.3 Break down force of tape

Cover tape (or top tape)	5 N min.
Bottom tape (only when the cavities of the carrier tape are punched type)	5 N min.

10.4 Peeling off force of tape

Speed of peeling off	300 mm/min
Peeling off force	0.1 N to 0.6 N (The lower limit is for typical value.)

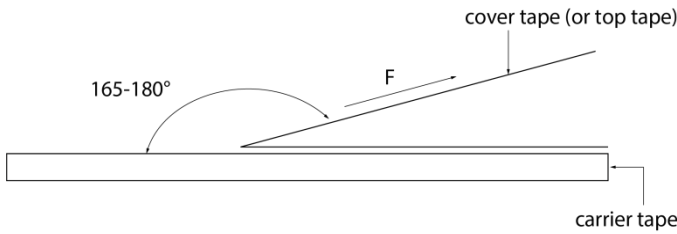

10.5 Dimensions of leader section, trailer section and reel

A vacant section is provided in the leader (start) section and trailer (end) section of the tape for the product. The leader section is further provided with an area consisting only of the cover tape (or top tape). (See the diagram below.)

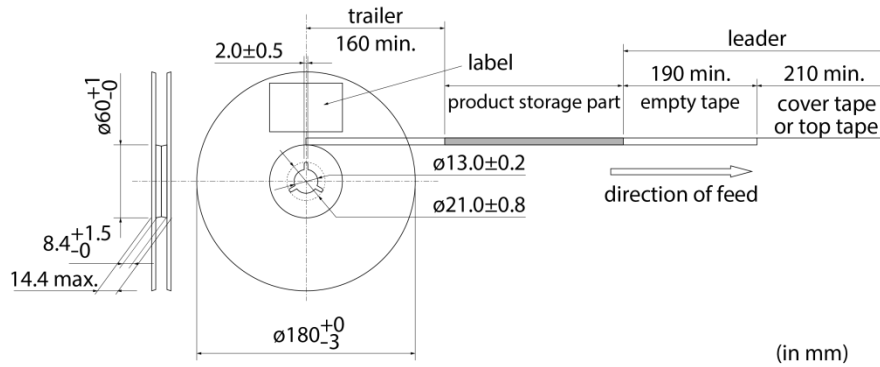

10.6 Marking for reel

Customer part number, Murata part number, inspection number (*1), RoHS marking (*2), quantity, etc.

<p>*1 Expression of inspection No.:</p> <table style="width: 100%; text-align: center;"> <tr> <td style="border: 1px solid black; padding: 2px;">□□</td> <td style="border: 1px solid black; padding: 2px;">○○○○</td> <td style="border: 1px solid black; padding: 2px;">◇◇◇◇</td> </tr> <tr> <td>(1)</td> <td>(2)</td> <td>(3)</td> </tr> </table>	□□	○○○○	◇◇◇◇	(1)	(2)	(3)	<p>(1) Factory code (2) Date First digit: year/last digit of year Second digit: month/Jan. to Sep. → 1 to 9, Oct. to Dec. → O, N, D Third, Fourth digit: day (3) Serial No.</p>
□□	○○○○	◇◇◇◇					
(1)	(2)	(3)					
<p>*2 Expression of RoHS marking:</p> <table style="width: 100%; text-align: center;"> <tr> <td style="border: 1px solid black; padding: 2px;">ROHS-</td> <td style="border: 1px solid black; padding: 2px;">Y</td> <td style="border: 1px solid black; padding: 2px;">(△)</td> </tr> <tr> <td></td> <td>(1)</td> <td>(2)</td> </tr> </table>	ROHS-	Y	(△)		(1)	(2)	<p>(1) RoHS regulation conformity (2) Murata classification number</p>
ROHS-	Y	(△)					
	(1)	(2)					

10.7 Marking on outer box (corrugated box)

Customer name, purchasing order number, customer part number, Murata part number, RoHS marking (*2), quantity, etc.

10.8 Specification of outer box

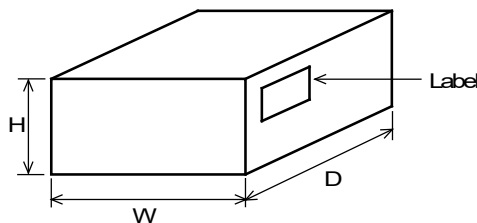

Dimensions of outer box (mm)			Standard reel quantity in outer box (reel)
W	D	H	
186	186	93	5
* Above outer box size is typical. It depends on a quantity of an order.			

11. ⚠ Caution

11.1 Limitation of applications

The products listed in the reference specification (hereinafter the product(s) is called as the "Product(s)") are designed and manufactured for applications specified in the reference specification (hereinafter called as the "Specific Application"). We shall not warrant anything in connection with the Products including fitness, performance, adequateness, safety, or quality, in the case of applications listed in from (1) to (11) written at the end of this precautions, which may generally require high performance, function, quality, management of production or safety. Therefore, the Product shall be applied in compliance with the specific application.

WE DISCLAIM ANY LOSS AND DAMAGES ARISING FROM OR IN CONNECTION WITH THE PRODUCTS INCLUDING BUT NOT LIMITED TO THE CASE SUCH LOSS AND DAMAGES CAUSED BY THE UNEXPECTED ACCIDENT, IN EVENT THAT (i) THE PRODUCT IS APPLIED FOR THE PURPOSE WHICH IS NOT SPECIFIED AS THE SPECIFIC APPLICATION FOR THE PRODUCT, AND/OR (ii) THE PRODUCT IS APPLIED FOR ANY FOLLOWING APPLICATION PURPOSES FROM (1) TO (11) (EXCEPT THAT SUCH APPLICATION PURPOSE IS UNAMBIGUOUSLY SPECIFIED AS SPECIFIC APPLICATION FOR THE PRODUCT IN OUR CATALOG SPECIFICATION FORMS, DATASHEETS, OR OTHER DOCUMENTS OFFICIALLY ISSUED BY US*).

- (1) Aircraft equipment
- (2) Aerospace equipment
- (3) Undersea equipment
- (4) Power plant control equipment
- (5) Medical equipment
- (6) Transportation equipment
- (7) Traffic control equipment
- (8) Disaster prevention/security equipment
- (9) Industrial data-processing equipment
- (10) Combustion/explosion control equipment
- (11) Equipment with complexity and/or required reliability equivalent to the applications listed in the above.

For exploring information of the Products which will be compatible with the particular purpose other than those specified in the reference specification, please contact our sales offices, distribution agents, or trading companies with which you make a deal, or via our web contact form.

Contact form: <https://www.murata.com/contactform>

* We may design and manufacture particular Products for applications listed in (1) to (11). Provided that, in such case we shall unambiguously specify such Specific Application in the reference specification without any exception. Therefore, any other documents and/or performances, whether exist or non-exist, shall not be deemed as the evidence to imply that we accept the applications listed in (1) to (11).

11.2 Precautions on rating

Avoid using in exceeded the rated temperature range, rated voltage, or rated current.

Usage when the ratings are exceeded could lead to wire breakage, burning, or other serious fault.

11.3 Inrush current

If an inrush current (or pulse current or rush current) that significantly exceeds the rated current is applied to the product, overheating could occur, resulting in wire breakage, burning, or other serious fault.

12. Precautions for Use

This product is for use only with reflow soldering. It is designed to be mounted by soldering. If you want to use other mounting method, for example, using a conductive adhesive, please consult us beforehand.

Also, if repeatedly subjected to temperature cycles or other thermal stress, due to the difference in the coefficient of thermal expansion with the mounting substrate, the solder (solder fillet part) in the mounting part may crack.

The occurrence of cracks due to thermal stress is affected by the size of the land where mounted, the solder volume, and the heat dissipation of the mounting substrate. Carefully design it when a large change in ambient temperature is assumed.

12.1 Land dimensions

The following diagram shows the recommended land dimensions for reflow soldering:

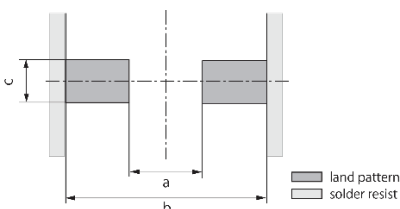

a	0.2 to 0.3
b	0.8 to 0.9
c	0.2 to 0.3

(in mm)

12.2 Flux and solder used

Flux	<ul style="list-style-type: none"> • Use a rosin-based flux. • Do not use a highly acidic flux with a halide content exceeding 0.2 mass% (chlorine conversion value). • Do not use a water-soluble flux.
Solder	<ul style="list-style-type: none"> • Use Sn-3.0Ag-0.5Cu solder. • Standard thickness of solder paste: 100 μm to 150 μm

If you want to use a flux other than the above, please consult our technical department.

12.3 Soldering conditions (reflow)

- Pre-heating should be in such a way that the temperature difference between solder and product surface is limited to 150°C max.
Cooling into solvent after soldering also should be in such a way that the temperature difference is limited to 100°C max. Insufficient pre-heating may cause cracks on the product, resulting in the deterioration of product quality.
- Standard soldering profile and the limit soldering profile is as follows.
The excessive limit soldering conditions may cause leaching of the electrode and/or resulting in the deterioration of product quality.

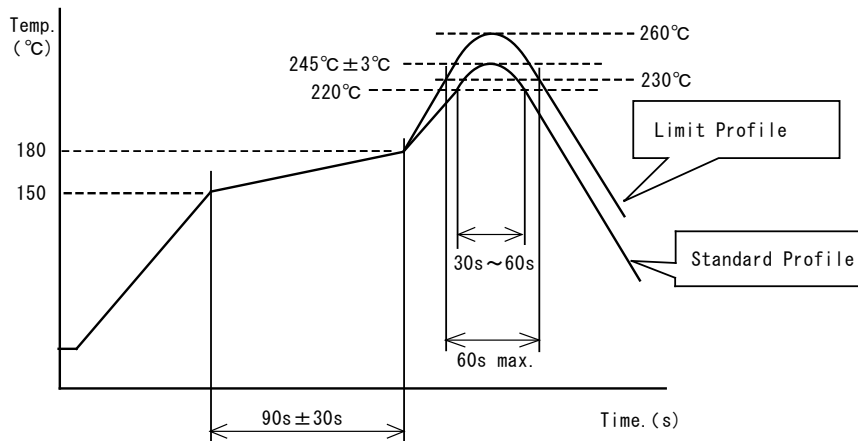

	Standard profile	Limit profile
Pre-heating	150°C to 180°C/90 s ± 30 s	150°C to 180°C/90 s ± 30 s
Heating	Above 220°C/30 s to 60 s	Above 230°C/60 s max.
Peak temperature	245°C ± 3°C	260°C/10 s
Number of reflow cycles	2 times	2 times

12.4 Reworking with soldering iron

The following requirements must be met to rework a soldered product using a soldering iron.

Item	Requirement
Pre-heating	150°C/approx. 1 min
Tip temperature of soldering iron	350°C max.
Power consumption of soldering iron	80 W max.
Tip diameter of soldering iron	ø3 mm max.
Soldering time	3 s (+1 s, -0 s)
Number of reworking operations	2 times max.

* Avoid a direct contact of the tip of the soldering iron with the product. Such a direction contact may cause cracks in the ceramic body due to thermal shock.

12.5 Solder volume

Solder shall be used not to be exceeded the upper limits as shown below.

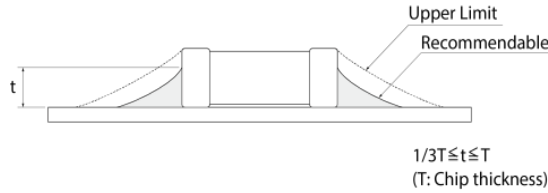

An increased solder volume increases mechanical stress on the product. Exceeding solder volume may cause the failure of mechanical or electrical performance.

12.6 Product's location

The following shall be considered when designing and laying out PCBs.

(1) PCB shall be designed so that products are not subject to mechanical stress due to warping the board.

[Products direction]

Products shall be located in the sideways direction (length: $a < b$) to the mechanical stress.

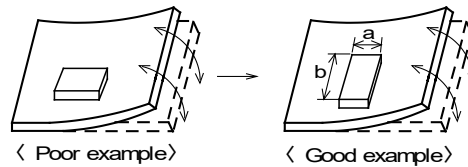

(2) Components location on PCB separation

It is effective to implement the following measures, to reduce stress in separating the board.

It is best to implement all of the following three measures; however, implement as many measures as possible to reduce stress.

Contents of measures	Stress level
(1) Turn the mounting direction of the component parallel to the board separation surface.	$A > D^{*1}$
(2) Add slits in the board separation part.	$A > B$
(3) Keep the mounting position of the component away from the board separation surface.	$A > C$
*1 $A > D$ is valid when stress is added vertically to the perforation as with hand separation. If a cutting disc is used, stress will be diagonal to the PCB, therefore $A > D$ is invalid.	

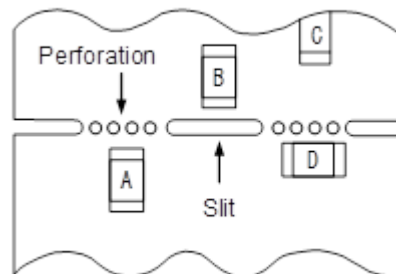

(3) Mounting components near screw holes

When a component is mounted near a screw hole, it may be affected by the board deflection that occurs during the tightening of the screw.

Mount the component in a position as far away from the screw holes as possible.

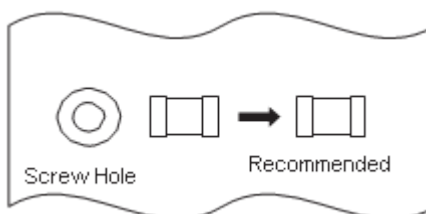

12.7 Handling of substrate

(1) The stress applied to the chip varies depending on the material and construction of the mounted substrate.

If the coefficients of thermal expansion for the substrate and chip vary significantly, the difference in thermal expansion and shrinkage could cause cracks to form in the chip.

We assume that the products are mounted on glass-epoxy substrate. Assessment has not been conducted on substrates where the coefficient of thermal expansion varies significantly from glass-epoxy substrates. If mounting on these substrates, be sure to conduct full assessments before use.

(2) After mounting products on a substrate, do not apply any stress to the product caused by bending or twisting to the substrate when cropping the substrate, inserting and removing a connector from the substrate or tightening screw to the substrate.

Excessive mechanical stress may cause cracking in the product.

Also, if mounting on flexible substrates, excessive mechanical stress could be applied to the chip by even slight bending or twisting when handling this substrate, and so please conduct full assessments before use.

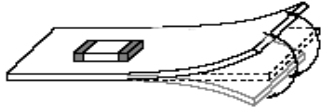

Bending

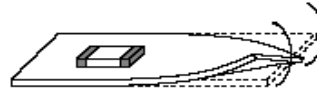

Twisting

12.8 Cleaning

Excessive ultrasonic oscillation during cleaning can cause the PCBs to resonate, resulting in cracked chips or broken solder joints. Before starting your production process, test your cleaning equipment / process to insure it does not degrade this product.

12.9 Storage and transportation

Storage period	Use the product within 12 months after delivery. If you do not use the product for more than 12 months, check solderability before using it.
Storage conditions	<ul style="list-style-type: none"> The products shall be stored in a room not subject to rapid changes in temperature and humidity. The recommended temperature range is -10°C to $+40^{\circ}\text{C}$. The recommended relative humidity range is 15% to 85%. Keeping the product in corrosive gases, such as sulfur, chlorine gas or acid may cause the poor solderability. Do not place the products directly on the floor; they should be placed on a palette so that they are not affected by humidity or dust. Avoid keeping the products in a place exposed to direct sunlight, heat or vibration. Do not keep products in bulk packaging. Bulk storage could result in collisions between the products or between the products and other parts, resulting in chipping or wire breakage. Avoid storing the product by itself bare (i.e. exposed directly to air).
Transportation	Excessive vibration and impact reduces the reliability of the products. Exercise caution when handling the products.

12.10 Resin coating (including moisture-proof coating)

When the product is coated/molded with resin, its electrical characteristics may change.

A wire breakage issue may occur by mechanical stress caused by the resin, amount/cured shape of resin, or operating condition etc.

Some resins contain impurities or hydrolyzable chlorine, which could result in corrosion of the conducting materials, leading to wire breakage.

So, please pay your careful attention when you select resin in case of coating/molding the products with the resin.

Prior to use the coating resin, please make sure no reliability issue is observed by evaluating products mounted on your board.

12.11 Mounting conditions

Check the mounting condition before using.

Using mounting conditions (nozzles, equipment conditions, etc.) that are not suitable for products may lead to pick up errors, misalignment, or damage to the product.

12.12 Operating environment

Do not use this product under the following environmental conditions as it may cause deterioration of product quality.

(1) In the corrodible atmosphere such as acidic gases, alkaline gases, chlorine, sulfur gases, organic gases and etc.

(the sea breeze, Cl_2 , H_2S , NH_3 , SO_2 , NO_2 , etc)

(2) In the atmosphere where liquid such as organic solvent, may splash on the products.

(3) In the atmosphere where the temperature/humidity changes rapidly and it is easy to dew.

12.13 Mounting density

If this product is placed near heat-generating products, be sure to implement sufficient heat-dissipating measures.

If this product is subjected to a significant amount of heat from other products, this could adversely affect product quality, resulting in a circuit malfunction or failure of the mounted section. Also, be sure that the product is used in a manner so that the heat that the product is subjected to from other products does not exceed the upper limit of the rated operating temperature for the product.

13. ⚠Note

- (1) Please make sure that your product has been evaluated in view of your specifications with our product being mounted to your product.
- (2) You are requested not to use our product deviating from the reference specifications.
- (3) The contents of this reference specification are subject to change without advance notice. Please approve our product specifications or transact the approval sheet for product specifications before ordering.

Appendix

Electrical performance: Measuring method for inductance/Q (Q measurement is applicable only when the Q value is included in the rating table.)

Perform measurement using the method described below. (Perform correction for the error deriving from the measuring terminal.)

(1) Residual elements and stray elements of the measuring terminal can be expressed by the F parameter for the 2-pole terminal as shown in the figure below.

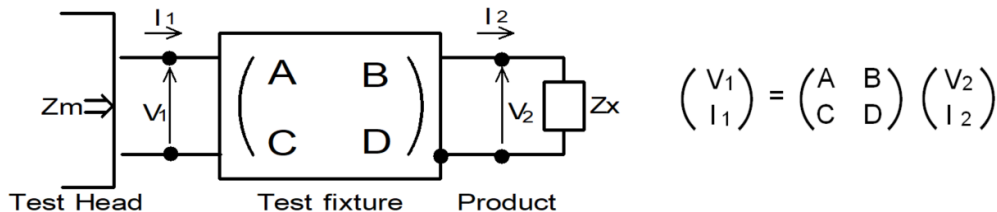

(2) The product's impedance value (Zx) and measured impedance value (Zm) can be expressed as shown below, by using the respective current and voltage for input/output.

$$Z_m = \frac{V_1}{I_1} \quad Z_x = \frac{V_2}{I_2}$$

(3) Thus, the relationship between the product's impedance value (Zx) and measured impedance value (Zm) is as follows.

$Z_x = \alpha \frac{Z_m - \beta}{1 - Z_m \Gamma}$	<p>Here,</p> <p>$\alpha = D/A = 1$</p> <p>$\beta = B/D = Z_{sm} - (1 - Y_{om} Z_{sm}) Z_{ss}$</p> <p>$\Gamma = C/A = Y_{om}$</p> <p>$Z_{sm}$: measured impedance of short chip</p> <p>Z_{ss}: residual impedance of short chip (0 nH)</p> <p>Y_{om}: measured admittance when measuring terminal is open</p>
---	--

(4) Calculate inductance Lx and Qx using the equations shown below.

$L_x = \frac{\text{Im}(Z_x)}{2\pi f}$	<p>L_x: inductance of chip coil</p>
$Q_x = \frac{\text{Im}(Z_x)}{\text{Re}(Z_x)}$	<p>Q_x: Q of chip coil</p> <p>f: measuring frequency</p>

OUR CERTIFICATE

DiGi provide top-quality products and perfect service for customer worldwide through standardization, technological innovation and continuous improvement. DiGi through third-party certification, we stricly control the quality of products and services. Welcome your RFQ to

Email: Info@DiGi-Electronics.com



Tel: +00 852-30501935

RFQ Email: Info@DiGi-Electronics.com

DiGi is a global authorized distributor of electronic components.