

# LQP15MN6N8B02D Datasheet

[www.digi-electronics.com](http://www.digi-electronics.com)

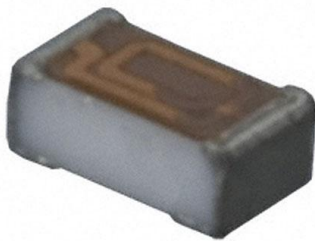

<https://www.DiGi-Electronics.com>

DiGi Electronics Part Number	LQP15MN6N8B02D-DG
Manufacturer	<a href="#">Murata Electronics</a>
Manufacturer Product Number	LQP15MN6N8B02D
Description	FIXED IND 6.8NH 130MA 900MOHM SM
Detailed Description	6.8 nH Unshielded Thick Film Inductor 130 mA 900m Ohm Max 0402 (1005 Metric)



Tel: +00 852-30501935

RFQ Email: [Info@DiGi-Electronics.com](mailto:Info@DiGi-Electronics.com)

DiGi is a global authorized distributor of electronic components.



## Purchase and inquiry

**Manufacturer Product Number:**

LQP15MN6N8B02D

**Series:**

LQP15

**Type:**

Thick Film

**Inductance:**

6.8 nH

**Current Rating (Amps):**

130 mA

**Shielding:**

Unshielded

**Q @ Freq:**

13 @ 500MHz

**Ratings:**

-

**Inductance Frequency - Test:**

500 MHz

**Package / Case:**

0402 (1005 Metric)

**Size / Dimension:**

0.039" L x 0.020" W (1.00mm x 0.50mm)

**Base Product Number:**

LQP15MN

**Manufacturer:**

Murata Electronics

**Product Status:**

Obsolete

**Material - Core:**

Non-Magnetic

**Tolerance:**

±0.1nH

**Current - Saturation (Isat):**

-

**DC Resistance (DCR):**

900mOhm Max

**Frequency - Self Resonant:**

6GHz

**Operating Temperature:**

-40°C ~ 85°C

**Mounting Type:**

Surface Mount

**Supplier Device Package:**

0402 (1005 Metric)

**Height - Seated (Max):**

0.018" (0.45mm)

## Environmental & Export classification

**RoHS Status:**

ROHS3 Compliant

**REACH Status:**

REACH Unaffected

**HTSUS:**

8504.50.8000

**Moisture Sensitivity Level (MSL):**

1 (Unlimited)

**ECCN:**

EAR99

# Reference Only

Spec No.JELF243C-0007Q-01

P.1/10

## CHIP COIL (CHIP INDUCTORS) LQP15MN□□□□02D Reference Specification

### 1.Scope

This reference specification applies to LQP15MN\_02 series, Chip coil (Chip Inductors).

### 2.Part Numbering

(ex)   LQ     P     15     M     N     1N0     W     0     2     D    
 Product ID Structure Dimension Applications Category Inductance Tolerance Features Electrode Packaging  
 (L × W) and Characteristics D:Taping \*B:Bulk

Bulk packing also available. (A product is put in the plastic bag under the taping conditions.)

### 3.Rating

- Operating Temperature Range.            -40°C to +85°C  
 (Ambient temperature: Rated current can be handled in this temperature range.)
- Storage Temperature Range.           -40°C to +85°C

Customer Part Number	MURATA Part Number	Inductance		Q (min)	DC Resistance (Ω max)	Self Resonant Frequency (MHz min)	Rated Current (mA)
		(nH)	Tolerance				
	LQP15MN1N0W02D	1.0	W:±0.05nH B:±0.1nH	13	0.1	6000	400
	LQP15MN1N0B02D						
	LQP15MN1N1W02D	1.1					390
	LQP15MN1N1B02D						
	LQP15MN1N2W02D	1.2			0.2		280
	LQP15MN1N2B02D						
	LQP15MN1N3W02D	1.3					280
	LQP15MN1N3B02D						
	LQP15MN1N4W02D	1.4			0.2		280
	LQP15MN1N5W02D						
	LQP15MN1N5B02D	1.5			0.3		220
	LQP15MN1N6W02D						
	LQP15MN1N6B02D	1.6			0.2		280
	LQP15MN1N7W02D						
	LQP15MN1N8W02D	1.7			0.2		280
	LQP15MN1N8B02D						
	LQP15MN1N9W02D	1.8			0.3		220
	LQP15MN2N0W02D						
	LQP15MN2N0B02D	2.0			0.3		220
	LQP15MN2N1W02D						
	LQP15MN2N2W02D	2.1	0.4	190			
	LQP15MN2N2B02D						
	LQP15MN2N3W02D	2.2	0.4	190			
	LQP15MN2N4W02D						
	LQP15MN2N4B02D	2.3	0.4	190			
	LQP15MN2N5W02D						
	LQP15MN2N6W02D	2.4	0.4	190			
	LQP15MN2N7W02D						
	LQP15MN2N7B02D	2.5	0.4	190			
	LQP15MN2N8W02D						
	LQP15MN2N8W02D	2.6	0.4	190			
	LQP15MN2N9W02D						
	LQP15MN3N0W02D	2.7	0.4	190			
	LQP15MN3N0B02D						
	LQP15MN3N1W02D	2.8	0.4	190			
	LQP15MN3N2W02D						
	LQP15MN3N3W02D	2.9	0.4	190			
	LQP15MN3N3B02D						

# Reference Only

Spec No.JELF243C-0007Q-01

P.2/10

Customer Part Number	MURATA Part Number	Inductance		Q (min)	DC Resistance ( $\Omega$ max)	Self Resonant Frequency (MHz min)	Rated Current (mA)
		(nH)	Tolerance				
	LQP15MN3N4W02D	3.4	W: $\pm 0.05$ nH B: $\pm 0.1$ nH	13	0.5	6000	170
	LQP15MN3N5W02D	3.5					
	LQP15MN3N6W02D	3.6					
	LQP15MN3N6B02D						
	LQP15MN3N7W02D						
	LQP15MN3N8W02D	3.8					
	LQP15MN3N9W02D	3.9					
	LQP15MN3N9B02D						
	LQP15MN4N3B02D	4.3	B: $\pm 0.1$ nH		0.6		160
	LQP15MN4N7B02D	4.7					
	LQP15MN5N1B02D	5.1			0.7		140
	LQP15MN5N6B02D	5.6			0.9		130
	LQP15MN6N2B02D	6.2					
	LQP15MN6N8B02D	6.8					
	LQP15MN7N5B02D	7.5		G: $\pm 2\%$	1.1	110	
	LQP15MN8N2B02D	8.2	1.3		100		
	LQP15MN9N1B02D	9.1					
	LQP15MN10NG02D	10	1.3		100		
	LQP15MN12NG02D	12					
	LQP15MN15NG02D	15					
	LQP15MN18NG02D	18					
	LQP15MN22NG02D	22					
	LQP15MN27NG02D	27					
	LQP15MN33NG02D	33		3.8		60	

## 4. Testing Conditions

《Unless otherwise specified》

Temperature : Ordinary Temperature / 15°C to 35°C

Humidity : Ordinary Humidity / 25%(RH) to 85%(RH)

《In case of doubt》

Temperature : 20°C  $\pm$  2°C

Humidity : 60%(RH) to 70%(RH)

Atmospheric Pressure : 86kPa to 106 kPa

## 5. Appearance and Dimensions

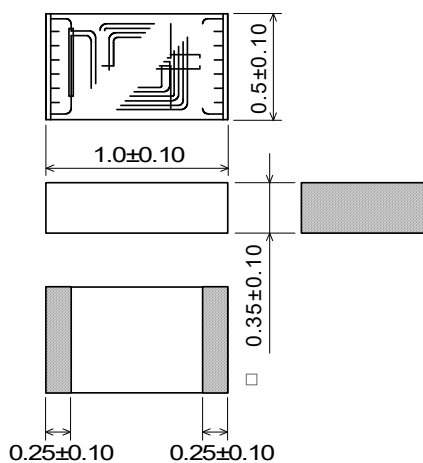

■ Unit Mass (Typical value)

0.0006g

\*The pattern of the coil differs in each inductance value.

(in mm)

# Reference Only

Spec No.JELF243C-0007Q-01

P.3/10

## 6.Electrical Performance

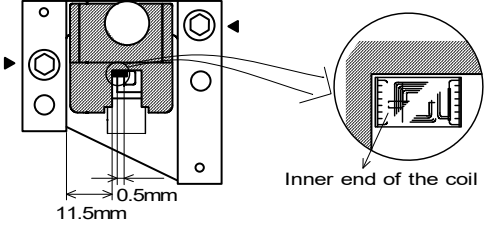
No.	Item	Specification	Test Method
6.1	Inductance	Inductance shall meet item 3.	Measuring Equipment: KEYSIGHT 4291A or equivalent Measuring Frequency:500MHz Measuring Condition: Test signal level / about 7dBm Electrical length / 0.94cm Weight / about 1N to 5N Measuring Fixture: KEYSIGHT 16193A Position coil under test as shown in below and contact coil with each terminal by adding weight. Coil pattern should be a topside, and inner end of the coil should be in the direction of the fixture for position of chip coil.
6.2	Q	Q shall meet item 3.	 Measuring Method:See the endnote. <Electrical Performance:Measuring Method of Inductance/Q>
6.3	DC Resistance	DC Resistance shall meet item 3.	Measuring Equipment:Digital multi meter
6.4	Self Resonant Frequency(S.R.F)	S.R.F shall meet item 3.	Measuring Equipment: KEYSIGHT 8753C or equivalent
6.5	Rated Current	Self temperature rise shall be limited to 25°C max.	The rated current is applied.

## 7.Mechanical Performance

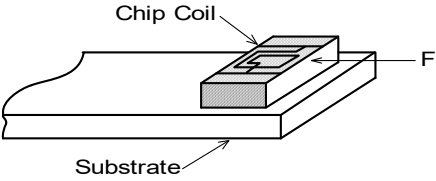
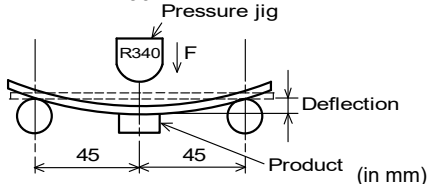
No.	Item	Specification	Test Method
7.1	Shear Test	Chip coil shall not be damaged after tested as test method.	Substrate:Glass-epoxy substrate Force:10N Hold Duration:5s±1s Applied Direction: Parallel to PCB. 
7.2	Bending Test	Chip coil shall not be damaged after tested as test method.	Substrate:Glass-epoxy substrate (100mm × 40mm × 1.6mm) Speed of Applying Force:1mm/s Deflection:2mm Hold Duration:30 s Pressure jig 

# Reference Only

Spec No.JELF243C-0007Q-01

P.4/10

No.	Item	Specification	Test Method
7.3	Vibration	Appearance:No damage Inductance Change: within $\pm 10\%$	Oscillation Frequency: 10Hz to 55Hz to 10Hz for 1 min Total Amplitude:1.5mm Testing Time: A period of 2 h in each of 3 mutually perpendicular directions.
7.4	Solderability	The electrode shall be at least 90% covered with new solder coating.	Flux: Ethanol solution of rosin 25(wt)% (Immersed for 5s to 10s) Solder:Sn-3.0Ag-0.5Cu Pre-Heating:150°C $\pm 10^\circ\text{C}$ / 60s to 90s Solder Temperature:240°C $\pm 5^\circ\text{C}$ Immersion Time:3s $\pm 1$ s
7.5	Resistance to Soldering Heat	Appearance:No damage Inductance Change: within $\pm 10\%$	Flux: Ethanol solution of rosin 25(wt)% (Immersed for 5s to 10s) Solder:Sn-3.0Ag-0.5Cu Pre-Heating:150°C $\pm 10^\circ\text{C}$ / 60s to 90s Solder Temperature:270°C $\pm 5^\circ\text{C}$ Immersion Time:10s $\pm 1$ s Then measured after exposure in the room condition for 24h $\pm 2$ h.

## 8.Environmental Performance

It shall be soldered on the substrate.

No.	Item	Specification	Test Method
8.1	Heat Resistance	Appearance:No damage Inductance Change: within $\pm 10\%$	Temperature:85°C $\pm 2^\circ\text{C}$ Time:1000h(+48h,-0h) Then measured after exposure in the room condition for 24h $\pm 2$ h.
8.2	Cold Resistance		Temperature:-40°C $\pm 2^\circ\text{C}$ Time:1000h(+48h,-0h) Then measured after exposure in the room condition for 24h $\pm 2$ h.
8.3	Humidity		Temperature:40°C $\pm 2^\circ\text{C}$ Humidity:90%(RH) to 95%(RH) Time:1000h(+48h,-0h) Then measured after exposure in the room condition for 24h $\pm 2$ h.
8.4	Temperature Cycle		1 cycle: 1 step:-40°C $\pm 2^\circ\text{C}$ / 30 min $\pm 3$ min 2 step:Ordinary temp. / 10 min to 15 min 3 step:+85°C $\pm 2^\circ\text{C}$ / 30 min $\pm 3$ min 4 step:Ordinary temp. / 10 min to 15 min Total of 10 cycles Then measured after exposure in the room condition for 24h $\pm 2$ h.

## 9.Specification of Packaging

### 9.1 Appearance and Dimensions of paper tape (8mm-wide)

Electrode which is connected to the inner end of the coil.

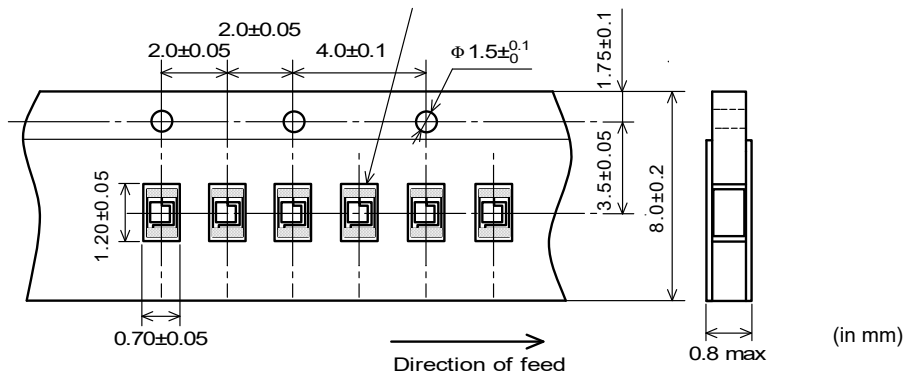

MURATA MFG.CO.,LTD

# Reference Only

Spec No. JELF243C-0007Q-01

P.5/10

### 9.2 Specification of Taping

- (1) Packing quantity (standard quantity)  
10,000 pcs / reel
- (2) Packing Method  
Products shall be packed in the cavity of the base tape and sealed by top tape and bottom tape.
- (3) Sprocket hole  
The sprocket holes are to the right as the tape is pulled toward the user.
- (4) Spliced point  
Base tape and Top tape has no spliced point.
- (5) Missing components number  
Missing components number within 0.1 % of the number per reel or 1 pc., whichever is greater, and are not continuous. The Specified quantity per reel is kept.

### 9.3 Pull Strength

Top tape	5N min.
Bottom tape	

### 9.4 Peeling off force of cover tape

Speed of Peeling off	300mm/min
Peeling off force	0.1N to 0.6N (minimum value is typical)

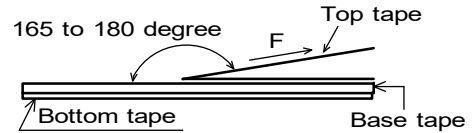

### 9.5 Dimensions of Leader-tape, Trailer and Reel

There shall be leader-tape ( top tape and empty tape) and trailer-tape (empty tape) as follows.

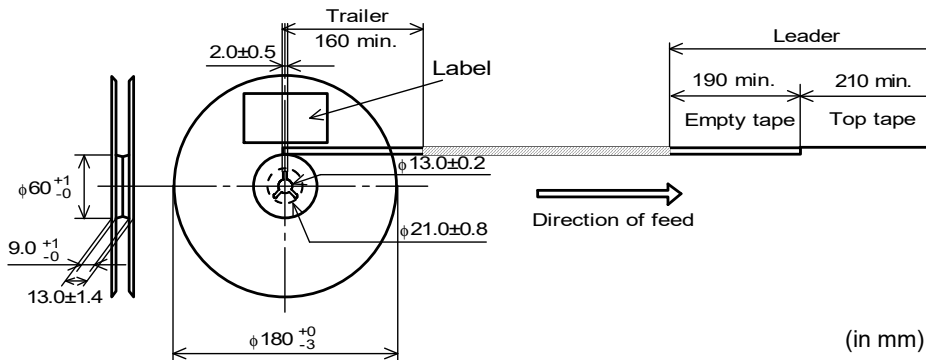

### 9.6 Marking for reel

Customer part number, MURATA part number, Inspection number(\*1) , RoHS Marking (\*2), Quantity etc ...

\*1) <Expression of Inspection No.>

□□ 0000 XXX  
(1) (2) (3)

(1) Factor

(2) Date

First digit : Year / Last digit of year

Second digit : Month / Jan. to Sep. → 1 to 9, Oct. to Dec. → O,N,D

Third, Fourth digit : Day

(3) Serial No.

\*2) <Expression of RoHS Marking>

ROHS - Y (Δ)  
(1) (2)

(1) RoHS regulation conformity parts.

(2) MURATA classification number

# Reference Only

Spec No.JELF243C-0007Q-01

P.6/10

## 9.7 Marking for Outside package (corrugated paper box)

Customer name, Purchasing order number, Customer part number, MURATA part number,  
RoHS Marking (\*2) ,Quantity, etc . . .

## 9.8. Specification of Outer Case

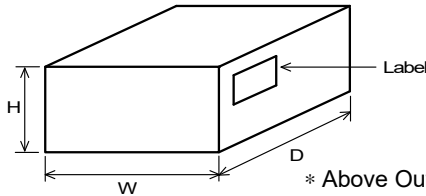

Outer Case Dimensions (mm)			Standard Reel Quantity in Outer Case (Reel)
W	D	H	
186	186	93	5

\* Above Outer Case size is typical. It depends on a quantity of an order.

## 10. Caution

### Limitation of Applications

Please contact us before using our products for the applications listed below which require especially high reliability for the prevention of defects which might directly cause damage to the third party's life, body or property.

- |                                   |  |
|-----------------------------------|--|
| (1) Aircraft equipment            | (6) Transportation equipment (vehicles, trains, ships, etc.)   |
| (2) Aerospace equipment           | (7) Traffic signal equipment   |
| (3) Undersea equipment            | (8) Disaster prevention / crime prevention equipment   |
| (4) Power plant control equipment | (9) Data-processing equipment  |
| (5) Medical equipment             | (10) Applications of similar complexity and /or reliability requirements to the applications listed in the above |

## 11. Notice

Products can only be soldered with reflow.

This product is designed for solder mounting.

Please consult us in advance for applying other mounting method such as conductive adhesive.

### 11.1 Land pattern designing

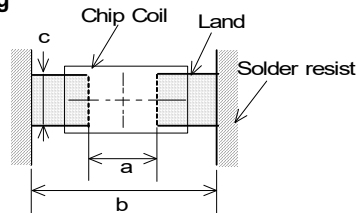

a	0.4
b	1.4~1.5
c	0.5~0.6

(in mm)

### 11.2 Flux, Solder

- Use rosin-based flux.  
Don't use highly acidic flux with halide content exceeding 0.2(wt)% (chlorine conversion value).  
Don't use water-soluble flux.
- Use Sn-3.0Ag-0.5Cu solder.
- Standard thickness of solder paste : 100  $\mu$ m~150  $\mu$ m.

### 11.3 Reflow soldering conditions

- Pre-heating should be in such a way that the temperature difference between solder and product surface is limited to 150°C max. Cooling into solvent after soldering also should be in such a way that the temperature difference is limited to 100°C max.  
Insufficient pre-heating may cause cracks on the product, resulting in the deterioration of products quality.
- Standard soldering profile and the limit soldering profile is as follows.  
The excessive limit soldering conditions may cause leaching of the electrode and / or resulting in the deterioration of product quality.



# Reference Only

Spec No.JELF243C-0007Q-01

P.7/10

## •Reflow soldering profile

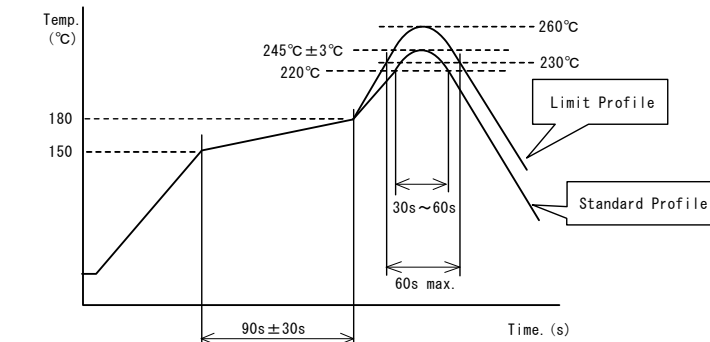

	Standard Profile	Limit Profile
Pre-heating	150°C ~ 180°C , 90s ± 30s	
Heating	above 220°C, 30s ~ 60s	above 230°C, 60s max.
Peak temperature	245°C ± 3°C	260°C, 10s
Cycle of reflow	2 times	2 times

### 11.4 Reworking with soldering iron

The following conditions must be strictly followed when using a soldering iron.

Pre-heating	150°C, 1 min
Tip temperature	350°C max.
Soldering iron output	80W max.
Tip diameter	φ 3mm max.
Soldering time	3(+1, -0)s
Time	2 times

Note : Do not directly touch the products with the tip of the soldering iron in order to prevent the crack on the products due to the thermal shock.

### 11.5 Solder Volume

•Solder shall be used not to be exceeded the upper limits as shown below.

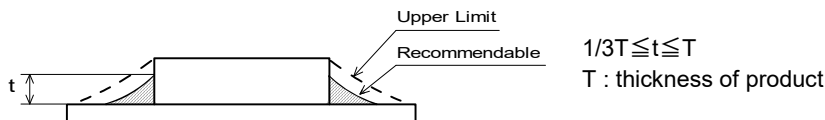

Accordingly increasing the solder volume, the mechanical stress to Chip is also increased. Exceeding solder volume may cause the failure of mechanical or electrical performance.

### 11.6 Attention regarding P.C.B. bending

The following shall be considered when designing and laying out P.C.B.'s.

- (1) P.C.B. shall be designed so that products are not subject to the mechanical stress due to warping the board.

[Products direction]

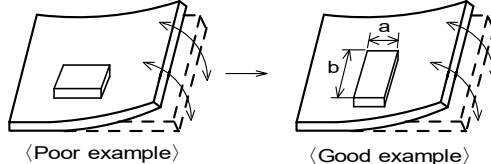

Products shall be located in the sideways direction (Length: a < b) to the mechanical stress.

- (2) Components location on P.C.B. separation.

It is effective to implement the following measures, to reduce stress in separating the board.

It is best to implement all of the following three measures; however, implement as many measures as possible to reduce stress.

# Reference Only

Spec No.JELF243C-0007Q-01

P.8/10

Contents of Measures	Stress Level
(1) Turn the mounting direction of the component parallel to the board separation surface.	$A > D^{*1}$
(2) Add slits in the board separation part.	$A > B$
(3) Keep the mounting position of the component away from the board separation surface.	$A > C$

\*1  $A > D$  is valid when stress is added vertically to the perforation as with Hand Separation.  
If a Cutting Disc is used, stress will be diagonal to the PCB, therefore  $A > D$  is invalid.

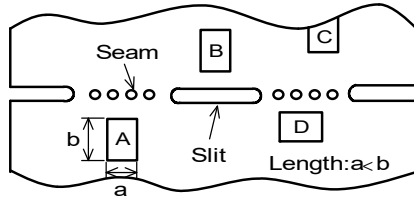

### (3) Mounting Components Near Screw Holes

When a component is mounted near a screw hole, it may be affected by the board deflection that occurs during the tightening of the screw. Mount the capacitor in a position as far away from the screw holes as possible.

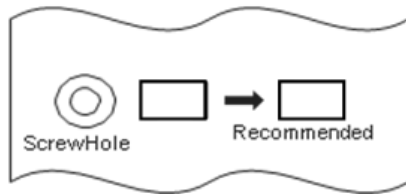

## 11.7 Cleaning Conditions

Products shall be cleaned on the following conditions.

- (1) Cleaning temperature shall be limited to 60°C max.(40°C max for IPA)
- (2) Ultrasonic cleaning shall comply with the following conditions with avoiding the resonance phenomenon at the mounted products and P.C.B.  
Power : 20 W / l max.    Frequency : 28kHz to 40kHz    Time : 5 min max.
- (3) Cleaner
  1. Alcohol type cleaner  
Isopropyl alcohol (IPA)
  2. Aqueous agent  
PINE ALPHA ST-100S
- (4) There shall be no residual flux and residual cleaner after cleaning.  
In the case of using aqueous agent, products shall be dried completely after rinse with de-ionized water in order to remove the cleaner.
- (5) Other cleaning    Please contact us.

## 11.8 Resin coating

Inductance value may be changed due to the large cure-stress of the resin when products are coated with resin. In this case, take care when you select resin to prevent the deterioration of the product quality.

## 11.9 Caution for use

The pattern of the chip coil is covered with the protection film. But the handling the chip coil shall be taken care so that the chip coil would not be damaged with the pick-up nozzle, the sharp substance and so on.

# Reference Only

Spec No.JELF243C-0007Q-01

P.9/10

## 11.10 Handling of a substrate

After mounting products on a substrate, do not apply any stress to the product caused by bending or twisting to the substrate when cropping the substrate, inserting and removing a connector from the substrate or tightening screw to the substrate.

Excessive mechanical stress may cause cracking in the product.

Bending

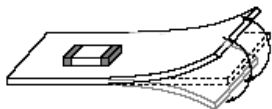

Twisting

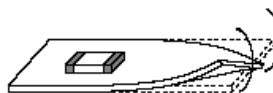

## 11.11 Storage and Handling Requirements

### (1) Storage period

Use the products within 12 months after delivered. Solderability should be checked if this period is exceeded.

### (2) Storage conditions

• Products should be stored in the warehouse on the following conditions.

Temperature : -10°C ~ 40°C

Humidity : 15% to 85% relative humidity No rapid change on temperature and humidity.

• Products should not be stored on bulk packaging condition to prevent the chipping of the core and the breaking of winding wire caused by the collision between the products.

• Products should be stored on the pallet for the prevention of the influence from humidity, dust and so on.

• Products should be stored in the warehouse without heat shock, vibration, direct sunlight and so on.

### (3) Handling Condition

Care should be taken when transporting or handling product to avoid excessive vibration or mechanical shock.

## 12. Structure, Construction material

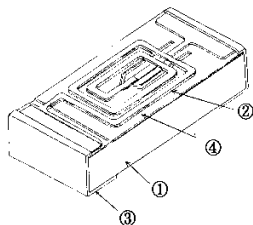

No.	Item	General Material Name
①	Substrate	Composition of Glass and Ceramic
②	Pattern of the Coil	Ni alloy + Ag plating
③	Electrode	Ni alloy + Ni plating + Sn plating
④	Coating	Polyimide

## 13. Notes

(1) Please make sure that your product has been evaluated in view of your specifications with our product being mounted to your product.

(2) You are requested not to use our product deviating from the reference specifications.

(3) The contents of this reference specification are subject to change without advance notice.

Please approve our product specifications or transact the approval sheet for product specifications before ordering.

# Reference Only

Spec No.JELF243C-0007Q-01

P.10/10

## <Electrical Performance:Measuring Method of Inductance/Q>

(1) Residual elements and stray elements of test fixture can be described by F-parameter shown in following.

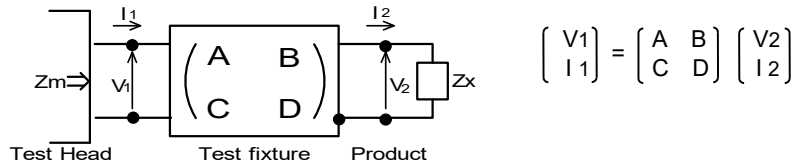

(2) The impedance of chip coil  $Z_x$  and measured value  $Z_m$  can be described by input/output current/voltage.

$$Z_m = \frac{V_1}{I_1}, \quad Z_x = \frac{V_2}{I_2}$$

(3) Thus, the relation between  $Z_x$  and  $Z_m$  is following;

$$Z_x = \alpha \frac{Z_m - \beta}{1 - Z_m \Gamma} \quad \text{where, } \alpha = D / A = 1$$

$$\beta = B / D = Z_{sm} - (1 - Y_{om} Z_{sm}) Z_{ss}$$

$$\Gamma = C / A = Y_{om}$$

$\left. \begin{array}{l} Z_{sm}: \text{measured impedance of short chip} \\ Z_{ss}: \text{residual impedance of short chip (0.556nH)} \\ Y_{om}: \text{measured admittance when opening the fixture} \end{array} \right\}$

(4)  $L_x$  and  $Q_x$  shall be calculated with the following equation.

$$L_x = \frac{\text{Im}(Z_x)}{2\pi f}, \quad Q_x = \frac{\text{Im}(Z_x)}{\text{Re}(Z_x)}$$

$L_x$  : Inductance of chip coil  
 $Q_x$  : Q of chip coil  
 $f$  : Measuring frequency

## OUR CERTIFICATE

DiGi provide top-quality products and perfect service for customer worldwide through standardization, technological innovation and continuous improvement. DiGi through third-party certification, we stricly control the quality of products and services. Welcome your RFQ to

Email: [Info@DiGi-Electronics.com](mailto:Info@DiGi-Electronics.com)



Tel: +00 852-30501935

RFQ Email: [Info@DiGi-Electronics.com](mailto:Info@DiGi-Electronics.com)

DiGi is a global authorized distributor of electronic components.