

LQW04AN9N2D00D Datasheet

www.digi-electronics.com

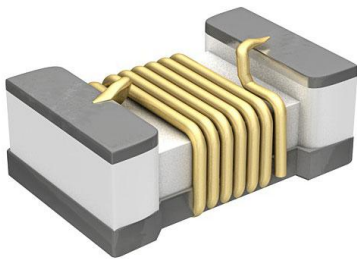

<https://www.DiGi-Electronics.com>

DiGi Electronics Part Number	LQW04AN9N2D00D-DG
Manufacturer	Murata Electronics
Manufacturer Product Number	LQW04AN9N2D00D
Description	FIXED IND
Detailed Description	Inductor



Tel: +00 852-30501935

RFQ Email: Info@DiGi-Electronics.com

DiGi is a global authorized distributor of electronic components.

Purchase and inquiry

Manufacturer Product Number:

LQW04AN9N2D00D

Series:

*

Base Product Number:

LQW04AN

Manufacturer:

Murata Electronics

Product Status:

Active

Environmental & Export classification

RoHS Status:

ROHS3 Compliant

REACH Status:

REACH Unaffected

HTSUS:

8504.50.8000

Moisture Sensitivity Level (MSL):

1 (Unlimited)

ECCN:

EAR99

Reference Only

Spec No.: JELF243A_0090M-01

P1/16

CHIP COIL (CHIP INDUCTOR) for Consumer equipment & Industrial equipment LQW04AN□□□□00 REFERENCE SPECIFICATION

1. Scope

This reference specification applies to chip coil (chip inductor) LQW04AN_00 series.

1.1 Specific applications:

- Power equipment: Products that can be used in power equipment such as renewable energy equipment, energy storage equipment and EV charging equipment and whose functions are not directly related to the protection of human life and property.
- Industrial equipment: Products that can be used in industrial equipment such as base stations, manufacturing equipment, industrial robotics equipment, and measurement equipment, and whose functions do not directly relate to the protection of human life and property.
- Medical equipment (GHTF Class C) *Except for implant/surgery/auto injector: Products that can be used for medical equipment of Class C of the international classification class GHTF and whose malfunction is considered to pose a relatively high risk to the human body.
- Medical equipment (GHTF Class A and B): Products that can be used for medical equipment regulated by Class A and Class B of the international classification class GHTF and whose functions do not directly relate to the protection of human life and property.
- Consumer equipment: Products that can be used in consumer equipment such as home appliances, audio/visual equipment, communication equipment, information equipment, office equipment, and household robotics, and whose functions are not directly related to the protection of human life and property.

1.2 Unsuitable application:

Applications listed in "Limitation of applications" in this reference specification.

2. Part Numbering

(Ex.)

LQ	W	04	A	N	0N8	C	0	0	D
Product ID	Structure	Dimension (L × W)	Application and characteristic	Category	Inductance	Tolerance	Performance	Electrode specification	Packaging D: taping *B: bulk

*B: Bulk packing is also available (taping condition: however, products without reels are put in plastic bags).

3. Part Number and Rating

Operating temperature range	-55°C to +125°C
Storage temperature range	-55°C to +125°C

Customer Part number	Murata Part number	Inductance		Q (Min.)	DC resistance (Ω max.)	Self-resonant frequency (GHz min.)	Rated current (mA)
		Nominal value (nH)	Tolerance				
	LQW04AN0N8C00D	0.8	C: ±0.2 nH	23	0.02	20.0	1800
	LQW04AN0N8D00D	0.8	D: ±0.5 nH	23	0.02	20.0	1800
	LQW04AN1N1C00D	1.1	C: ±0.2 nH	15	0.03	20.0	990
	LQW04AN1N1D00D	1.1	D: ±0.5 nH	15	0.03	20.0	990
	LQW04AN1N3C00D	1.3	C: ±0.2 nH	15	0.03	20.0	1500
	LQW04AN1N3D00D	1.3	D: ±0.5 nH	15	0.03	20.0	1500
	LQW04AN1N4C00D	1.4	C: ±0.2 nH	15	0.03	20.0	1200
	LQW04AN1N4D00D	1.4	D: ±0.5 nH	15	0.03	20.0	1200
	LQW04AN1N5C00D	1.5	C: ±0.2 nH	18	0.05	20.0	940
	LQW04AN1N5D00D	1.5	D: ±0.5 nH	18	0.05	20.0	940
	LQW04AN1N6C00D	1.6	C: ±0.2 nH	15	0.06	17.0	700
	LQW04AN1N6D00D	1.6	D: ±0.5 nH	15	0.06	17.0	700
	LQW04AN1N7C00D	1.7	C: ±0.2 nH	15	0.06	17.0	700
	LQW04AN1N7D00D	1.7	D: ±0.5 nH	15	0.06	17.0	700
	LQW04AN1N8C00D	1.8	C: ±0.2 nH	15	0.06	17.0	700
	LQW04AN1N8D00D	1.8	D: ±0.5 nH	15	0.06	17.0	700

Reference Only

Spec No.: JELF243A_0090M-01

P2/16

Customer Part number	Murata Part number	Inductance		Q (Min.)	DC resistance (Ω max.)	Self-resonant frequency (GHz min.)	Rated current (mA)
		Nominal value (nH)	Tolerance				
	LQW04AN2N0C00D	2.0	C: ± 0.2 nH	21	0.03	20.0	1100
	LQW04AN2N0D00D	2.0	D: ± 0.5 nH	21	0.03	20.0	1100
	LQW04AN2N1C00D	2.1	C: ± 0.2 nH	14	0.03	12.0	1100
	LQW04AN2N1D00D	2.1	D: ± 0.5 nH	14	0.03	12.0	1100
	LQW04AN2N2C00D	2.2	C: ± 0.2 nH	21	0.04	12.0	1100
	LQW04AN2N2D00D	2.2	D: ± 0.5 nH	21	0.04	12.0	1100
	LQW04AN2N3C00D	2.3	C: ± 0.2 nH	18	0.07	20.0	780
	LQW04AN2N3D00D	2.3	D: ± 0.5 nH	18	0.07	20.0	780
	LQW04AN2N4C00D	2.4	C: ± 0.2 nH	15	0.07	15.0	570
	LQW04AN2N4D00D	2.4	D: ± 0.5 nH	15	0.07	15.0	570
	LQW04AN2N5C00D	2.5	C: ± 0.2 nH	10	0.12	10.0	490
	LQW04AN2N5D00D	2.5	D: ± 0.5 nH	10	0.12	10.0	490
	LQW04AN2N6C00D	2.6	C: ± 0.2 nH	15	0.07	15.0	620
	LQW04AN2N6D00D	2.6	D: ± 0.5 nH	15	0.07	15.0	620
	LQW04AN2N7C00D	2.7	C: ± 0.2 nH	15	0.07	15.0	570
	LQW04AN2N7D00D	2.7	D: ± 0.5 nH	15	0.07	15.0	570
	LQW04AN2N8C00D	2.8	C: ± 0.2 nH	15	0.07	15.0	620
	LQW04AN2N8D00D	2.8	D: ± 0.5 nH	15	0.07	15.0	620
	LQW04AN2N9C00D	2.9	C: ± 0.2 nH	10	0.12	13.0	490
	LQW04AN2N9D00D	2.9	D: ± 0.5 nH	10	0.12	13.0	490
	LQW04AN3N0C00D	3.0	C: ± 0.2 nH	15	0.07	13.0	620
	LQW04AN3N0D00D	3.0	D: ± 0.5 nH	15	0.07	13.0	620
	LQW04AN3N1C00D	3.1	C: ± 0.2 nH	10	0.12	10.0	490
	LQW04AN3N1D00D	3.1	D: ± 0.5 nH	10	0.12	10.0	490
	LQW04AN3N2C00D	3.2	C: ± 0.2 nH	10	0.17	9.0	400
	LQW04AN3N2D00D	3.2	D: ± 0.5 nH	10	0.17	9.0	400
	LQW04AN3N3C00D	3.3	C: ± 0.2 nH	10	0.14	10.0	440
	LQW04AN3N3D00D	3.3	D: ± 0.5 nH	10	0.14	10.0	440
	LQW04AN3N6C00D	3.6	C: ± 0.2 nH	15	0.10	13.0	530
	LQW04AN3N6D00D	3.6	D: ± 0.5 nH	15	0.10	13.0	530
	LQW04AN3N7C00D	3.7	C: ± 0.2 nH	20	0.14	10.0	440
	LQW04AN3N7D00D	3.7	D: ± 0.5 nH	20	0.14	10.0	440
	LQW04AN3N8C00D	3.8	C: ± 0.2 nH	15	0.10	11.0	530
	LQW04AN3N8D00D	3.8	D: ± 0.5 nH	15	0.10	11.0	530
	LQW04AN3N9C00D	3.9	C: ± 0.2 nH	15	0.10	12.0	530
	LQW04AN3N9D00D	3.9	D: ± 0.5 nH	15	0.10	12.0	530
	LQW04AN4N0C00D	4.0	C: ± 0.2 nH	15	0.10	11.0	530
	LQW04AN4N0D00D	4.0	D: ± 0.5 nH	15	0.10	11.0	530
	LQW04AN4N1C00D	4.1	C: ± 0.2 nH	15	0.10	11.0	530
	LQW04AN4N1D00D	4.1	D: ± 0.5 nH	15	0.10	11.0	530
	LQW04AN4N2C00D	4.2	C: ± 0.2 nH	15	0.10	11.0	530
	LQW04AN4N2D00D	4.2	D: ± 0.5 nH	15	0.10	11.0	530
	LQW04AN4N3C00D	4.3	C: ± 0.2 nH	15	0.10	11.0	530
	LQW04AN4N3D00D	4.3	D: ± 0.5 nH	15	0.10	11.0	530
	LQW04AN4N4C00D	4.4	C: ± 0.2 nH	20	0.14	10.0	440
	LQW04AN4N4D00D	4.4	D: ± 0.5 nH	20	0.14	10.0	440

Reference Only

Spec No.: JELF243A_0090M-01

P3/16

Customer Part number	Murata Part number	Inductance		Q (Min.)	DC resistance (Ω max.)	Self-resonant frequency (GHz min.)	Rated current (mA)
		Nominal value (nH)	Tolerance				
	LQW04AN4N5C00D	4.5	C: ± 0.2 nH	20	0.14	10.0	440
	LQW04AN4N5D00D	4.5	D: ± 0.5 nH	20	0.14	10.0	440
	LQW04AN4N6C00D	4.6	C: ± 0.2 nH	20	0.14	10.0	440
	LQW04AN4N6D00D	4.6	D: ± 0.5 nH	20	0.14	10.0	440
	LQW04AN4N7C00D	4.7	C: ± 0.2 nH	20	0.14	10.0	440
	LQW04AN4N7D00D	4.7	D: ± 0.5 nH	20	0.14	10.0	440
	LQW04AN4N8C00D	4.8	C: ± 0.2 nH	15	0.23	9.0	350
	LQW04AN4N8D00D	4.8	D: ± 0.5 nH	15	0.23	9.0	350
	LQW04AN4N9C00D	4.9	C: ± 0.2 nH	15	0.23	9.0	350
	LQW04AN4N9D00D	4.9	D: ± 0.5 nH	15	0.23	9.0	350
	LQW04AN5N0C00D	5.0	C: ± 0.2 nH	15	0.23	9.0	350
	LQW04AN5N0D00D	5.0	D: ± 0.5 nH	15	0.23	9.0	350
	LQW04AN5N1C00D	5.1	C: ± 0.2 nH	20	0.12	10.0	470
	LQW04AN5N1D00D	5.1	D: ± 0.5 nH	20	0.12	10.0	470
	LQW04AN5N2C00D	5.2	C: ± 0.2 nH	20	0.19	9.0	390
	LQW04AN5N2D00D	5.2	D: ± 0.5 nH	20	0.19	9.0	390
	LQW04AN5N3C00D	5.3	C: ± 0.2 nH	20	0.19	9.0	390
	LQW04AN5N3D00D	5.3	D: ± 0.5 nH	20	0.19	9.0	390
	LQW04AN5N4C00D	5.4	C: ± 0.2 nH	20	0.19	9.0	390
	LQW04AN5N4D00D	5.4	D: ± 0.5 nH	20	0.19	9.0	390
	LQW04AN5N5C00D	5.5	C: ± 0.2 nH	20	0.12	9.0	470
	LQW04AN5N5D00D	5.5	D: ± 0.5 nH	20	0.12	9.0	470
	LQW04AN5N6C00D	5.6	C: ± 0.2 nH	20	0.12	9.0	470
	LQW04AN5N6D00D	5.6	D: ± 0.5 nH	20	0.12	9.0	470
	LQW04AN5N7C00D	5.7	C: ± 0.2 nH	20	0.19	9.0	390
	LQW04AN5N7D00D	5.7	D: ± 0.5 nH	20	0.19	9.0	390
	LQW04AN5N8C00D	5.8	C: ± 0.2 nH	20	0.19	9.0	390
	LQW04AN5N8D00D	5.8	D: ± 0.5 nH	20	0.19	9.0	390
	LQW04AN5N9C00D	5.9	C: ± 0.2 nH	20	0.19	9.0	390
	LQW04AN5N9D00D	5.9	D: ± 0.5 nH	20	0.19	9.0	390
	LQW04AN6N0C00D	6.0	C: ± 0.2 nH	20	0.19	9.0	390
	LQW04AN6N0D00D	6.0	D: ± 0.5 nH	20	0.19	9.0	390
	LQW04AN6N1C00D	6.1	C: ± 0.2 nH	20	0.19	9.0	390
	LQW04AN6N1D00D	6.1	D: ± 0.5 nH	20	0.19	9.0	390
	LQW04AN6N2C00D	6.2	C: ± 0.2 nH	20	0.19	9.0	390
	LQW04AN6N2D00D	6.2	D: ± 0.5 nH	20	0.19	9.0	390
	LQW04AN6N3C00D	6.3	C: ± 0.2 nH	20	0.19	9.0	390
	LQW04AN6N3D00D	6.3	D: ± 0.5 nH	20	0.19	9.0	390
	LQW04AN6N4C00D	6.4	C: ± 0.2 nH	20	0.19	9.0	390
	LQW04AN6N4D00D	6.4	D: ± 0.5 nH	20	0.19	9.0	390
	LQW04AN6N5C00D	6.5	C: ± 0.2 nH	20	0.19	9.0	390
	LQW04AN6N5D00D	6.5	D: ± 0.5 nH	20	0.19	9.0	390
	LQW04AN6N6C00D	6.6	C: ± 0.2 nH	20	0.19	9.0	390
	LQW04AN6N6D00D	6.6	D: ± 0.5 nH	20	0.19	9.0	390
	LQW04AN6N7C00D	6.7	C: ± 0.2 nH	20	0.19	9.0	390
	LQW04AN6N7D00D	6.7	D: ± 0.5 nH	20	0.19	9.0	390

Reference Only

Spec No.: JELF243A_0090M-01

P4/16

Customer Part number	Murata Part number	Inductance		Q (Min.)	DC resistance (Ω max.)	Self-resonant frequency (GHz min.)	Rated current (mA)
		Nominal value (nH)	Tolerance				
	LQW04AN6N8C00D	6.8	C: ± 0.2 nH	20	0.14	9.0	440
	LQW04AN6N8D00D	6.8	D: ± 0.5 nH	20	0.14	9.0	440
	LQW04AN6N9C00D	6.9	C: ± 0.2 nH	20	0.14	8.0	440
	LQW04AN6N9D00D	6.9	D: ± 0.5 nH	20	0.14	8.0	440
	LQW04AN7N0C00D	7.0	C: ± 0.2 nH	20	0.14	8.0	440
	LQW04AN7N0D00D	7.0	D: ± 0.5 nH	20	0.14	8.0	440
	LQW04AN7N1C00D	7.1	C: ± 0.2 nH	20	0.14	8.0	440
	LQW04AN7N1D00D	7.1	D: ± 0.5 nH	20	0.14	8.0	440
	LQW04AN7N2C00D	7.2	C: ± 0.2 nH	20	0.14	8.0	440
	LQW04AN7N2D00D	7.2	D: ± 0.5 nH	20	0.14	8.0	440
	LQW04AN7N3C00D	7.3	C: ± 0.2 nH	20	0.14	8.0	440
	LQW04AN7N3D00D	7.3	D: ± 0.5 nH	20	0.14	8.0	440
	LQW04AN7N4C00D	7.4	C: ± 0.2 nH	20	0.14	8.0	440
	LQW04AN7N4D00D	7.4	D: ± 0.5 nH	20	0.14	8.0	440
	LQW04AN7N5C00D	7.5	C: ± 0.2 nH	20	0.14	8.0	440
	LQW04AN7N5D00D	7.5	D: ± 0.5 nH	20	0.14	8.0	440
	LQW04AN7N6C00D	7.6	C: ± 0.2 nH	20	0.23	8.0	350
	LQW04AN7N6D00D	7.6	D: ± 0.5 nH	20	0.23	8.0	350
	LQW04AN7N7C00D	7.7	C: ± 0.2 nH	20	0.23	8.0	350
	LQW04AN7N7D00D	7.7	D: ± 0.5 nH	20	0.23	8.0	350
	LQW04AN7N8C00D	7.8	C: ± 0.2 nH	20	0.23	8.0	350
	LQW04AN7N8D00D	7.8	D: ± 0.5 nH	20	0.23	8.0	350
	LQW04AN7N9C00D	7.9	C: ± 0.2 nH	20	0.23	8.0	350
	LQW04AN7N9D00D	7.9	D: ± 0.5 nH	20	0.23	8.0	350
	LQW04AN8N0C00D	8.0	C: ± 0.2 nH	20	0.23	8.0	350
	LQW04AN8N0D00D	8.0	D: ± 0.5 nH	20	0.23	8.0	350
	LQW04AN8N1C00D	8.1	C: ± 0.2 nH	20	0.23	8.0	350
	LQW04AN8N1D00D	8.1	D: ± 0.5 nH	20	0.23	8.0	350
	LQW04AN8N2C00D	8.2	C: ± 0.2 nH	20	0.23	8.0	350
	LQW04AN8N2D00D	8.2	D: ± 0.5 nH	20	0.23	8.0	350
	LQW04AN8N3C00D	8.3	C: ± 0.2 nH	20	0.23	8.0	350
	LQW04AN8N3D00D	8.3	D: ± 0.5 nH	20	0.23	8.0	350
	LQW04AN8N4C00D	8.4	C: ± 0.2 nH	20	0.23	8.0	350
	LQW04AN8N4D00D	8.4	D: ± 0.5 nH	20	0.23	8.0	350
	LQW04AN8N5C00D	8.5	C: ± 0.2 nH	15	0.33	7.0	290
	LQW04AN8N5D00D	8.5	D: ± 0.5 nH	15	0.33	7.0	290
	LQW04AN8N6C00D	8.6	C: ± 0.2 nH	15	0.33	7.0	290
	LQW04AN8N6D00D	8.6	D: ± 0.5 nH	15	0.33	7.0	290
	LQW04AN8N7C00D	8.7	C: ± 0.2 nH	15	0.33	7.0	290
	LQW04AN8N7D00D	8.7	D: ± 0.5 nH	15	0.33	7.0	290
	LQW04AN8N8C00D	8.8	C: ± 0.2 nH	15	0.33	7.0	290
	LQW04AN8N8D00D	8.8	D: ± 0.5 nH	15	0.33	7.0	290
	LQW04AN8N9C00D	8.9	C: ± 0.2 nH	20	0.26	7.0	330
	LQW04AN8N9D00D	8.9	D: ± 0.5 nH	20	0.26	7.0	330
	LQW04AN9N0C00D	9.0	C: ± 0.2 nH	20	0.26	7.0	330
	LQW04AN9N0D00D	9.0	D: ± 0.5 nH	20	0.26	7.0	330

Reference Only

Spec No.: JELF243A_0090M-01

P5/16

Customer Part number	Murata Part number	Inductance		Q (Min.)	DC resistance (Ω max.)	Self-resonant frequency (GHz min.)	Rated current (mA)
		Nominal value (nH)	Tolerance				
	LQW04AN9N1C00D	9.1	C: ± 0.2 nH	20	0.16	7.0	400
	LQW04AN9N1D00D	9.1	D: ± 0.5 nH	20	0.16	7.0	400
	LQW04AN9N2C00D	9.2	C: ± 0.2 nH	20	0.16	7.0	400
	LQW04AN9N2D00D	9.2	D: ± 0.5 nH	20	0.16	7.0	400
	LQW04AN9N3C00D	9.3	C: ± 0.2 nH	20	0.26	7.0	330
	LQW04AN9N3D00D	9.3	D: ± 0.5 nH	20	0.26	7.0	330
	LQW04AN9N4C00D	9.4	C: ± 0.2 nH	20	0.26	7.0	330
	LQW04AN9N4D00D	9.4	D: ± 0.5 nH	20	0.26	7.0	330
	LQW04AN9N5C00D	9.5	C: ± 0.2 nH	20	0.26	7.0	330
	LQW04AN9N5D00D	9.5	D: ± 0.5 nH	20	0.26	7.0	330
	LQW04AN9N6C00D	9.6	C: ± 0.2 nH	20	0.26	7.0	330
	LQW04AN9N6D00D	9.6	D: ± 0.5 nH	20	0.26	7.0	330
	LQW04AN9N7C00D	9.7	C: ± 0.2 nH	20	0.26	7.0	330
	LQW04AN9N7D00D	9.7	D: ± 0.5 nH	20	0.26	7.0	330
	LQW04AN9N8C00D	9.8	C: ± 0.2 nH	20	0.26	7.0	330
	LQW04AN9N8D00D	9.8	D: ± 0.5 nH	20	0.26	7.0	330
	LQW04AN9N9C00D	9.9	C: ± 0.2 nH	20	0.26	7.0	330
	LQW04AN9N9D00D	9.9	D: ± 0.5 nH	20	0.26	7.0	330
	LQW04AN10NH00D	10	H: $\pm 3.0\%$	20	0.26	7.0	330
	LQW04AN10NJ00D	10	J: $\pm 5.0\%$	20	0.26	7.0	330
	LQW04AN11NH00D	11	H: $\pm 3.0\%$	15	0.28	7.0	310
	LQW04AN11NJ00D	11	J: $\pm 5.0\%$	15	0.28	7.0	310
	LQW04AN12NH00D	12	H: $\pm 3.0\%$	15	0.28	6.0	310
	LQW04AN12NJ00D	12	J: $\pm 5.0\%$	15	0.28	6.0	310
	LQW04AN13NH00D	13	H: $\pm 3.0\%$	15	0.34	6.0	280
	LQW04AN13NJ00D	13	J: $\pm 5.0\%$	15	0.34	6.0	280
	LQW04AN14NH00D	14	H: $\pm 3.0\%$	15	0.34	6.0	280
	LQW04AN14NJ00D	14	J: $\pm 5.0\%$	15	0.34	6.0	280
	LQW04AN15NH00D	15	H: $\pm 3.0\%$	15	0.48	5.5	240
	LQW04AN15NJ00D	15	J: $\pm 5.0\%$	15	0.48	5.5	240
	LQW04AN16NH00D	16	H: $\pm 3.0\%$	15	0.38	5.5	270
	LQW04AN16NJ00D	16	J: $\pm 5.0\%$	15	0.38	5.5	270
	LQW04AN18NH00D	18	H: $\pm 3.0\%$	15	0.54	5.0	220
	LQW04AN18NJ00D	18	J: $\pm 5.0\%$	15	0.54	5.0	220
	LQW04AN19NH00D	19	H: $\pm 3.0\%$	15	0.73	5.0	160
	LQW04AN19NJ00D	19	J: $\pm 5.0\%$	15	0.73	5.0	160
	LQW04AN20NH00D	20	H: $\pm 3.0\%$	15	0.56	5.0	210
	LQW04AN20NJ00D	20	J: $\pm 5.0\%$	15	0.56	5.0	210
	LQW04AN22NH00D	22	H: $\pm 3.0\%$	15	0.63	5.0	200
	LQW04AN22NJ00D	22	J: $\pm 5.0\%$	15	0.63	5.0	200
	LQW04AN23NH00D	23	H: $\pm 3.0\%$	15	0.95	4.0	160
	LQW04AN23NJ00D	23	J: $\pm 5.0\%$	15	0.95	4.0	160
	LQW04AN24NH00D	24	H: $\pm 3.0\%$	15	0.95	4.0	160
	LQW04AN24NJ00D	24	J: $\pm 5.0\%$	15	0.95	4.0	160
	LQW04AN25NH00D	25	H: $\pm 3.0\%$	15	0.95	4.0	160
	LQW04AN25NJ00D	25	J: $\pm 5.0\%$	15	0.95	4.0	160

Reference Only

Spec No.: JELF243A_0090M-01

P6/16

Customer Part number	Murata Part number	Inductance		Q (Min.)	DC resistance (Ω max.)	Self-resonant frequency (GHz min.)	Rated current (mA)
		Nominal value (nH)	Tolerance				
	LQW04AN27NH00D	27	H: $\pm 3.0\%$	15	0.95	4.0	160
	LQW04AN27NJ00D	27	J: $\pm 5.0\%$	15	0.95	4.0	160
	LQW04AN33NH00D	33	H: $\pm 3.0\%$	15	1.11	4.0	140
	LQW04AN33NJ00D	33	J: $\pm 5.0\%$	15	1.11	4.0	140

4. Testing Conditions

Unless otherwise specified	Temperature: ordinary temperature (15°C to 35°C) Humidity: ordinary humidity [25% to 85% (RH)]
In case of doubt	Temperature: 20°C \pm 2°C Humidity: 60% to 70% (RH) Atmospheric pressure: 86 kPa to 106 kPa

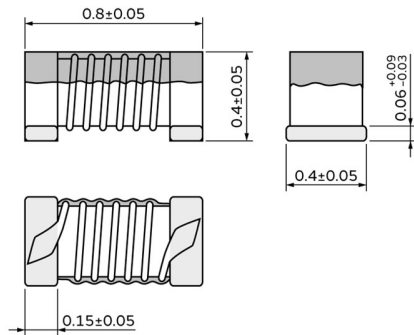
5. Appearance and Dimensions

(in mm)

Unit mass (typical value): 0.0003 g

6. Marking

No marking.

Reference Only

Spec No.: JELF243A_0090M-01

P7/16

7. Electrical Performance

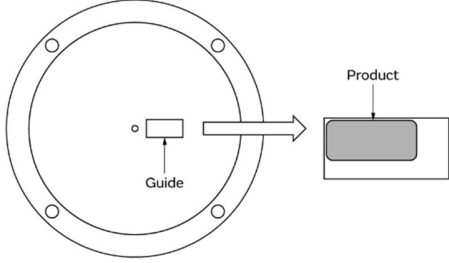
No.	Item	Specification	Test method
7.1	Inductance	Meet chapter 3 ratings.	Measuring equipment: Keysight E4991A or the equivalent Measuring frequency: Inductance: 100 MHz Q: 250 MHz Measuring conditions: Measurement signal level: Approx. 0 dBm Measurement terminal distance: 0.3 mm Electrical length: 10.0 mm Measuring fixture: Keysight 16197A Position the chip coil under test as shown in the measuring example below and connect it to the electrode by applying weight. Measurement example:
7.2	Q	Meet chapter 3 ratings.	 Measuring method: see "Electrical performance: Measuring method for inductance/Q" in the chapter "16. Appendix".
7.3	DC resistance	Meet chapter 3 ratings.	Measuring equipment: digital multimeter
7.4	Self-resonant frequency	Meet chapter 3 ratings.	Measuring equipment: Keysight N5230A or the equivalent
7.5	Rated current	Product temperature rise: 20°C max.	Apply the rated current specified in chapter 3.

8. Mechanical Performance

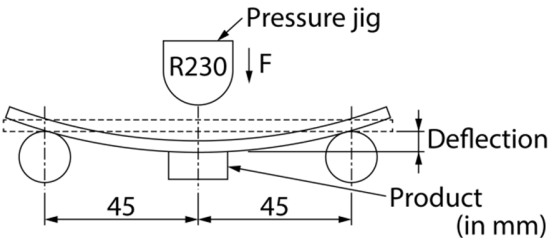
No.	Item	Specification	Test method
8.1	Bending test	No significant mechanical damage or no sign of electrode peeling off shall be observed.	Test substrate: glass-epoxy substrate (100 mm × 40 mm × 0.8 mm) Pressurizing speed: 1 mm/s Deflection: 2 mm Holding time: 5 s 
8.2	Vibration	Appearance shall have no significant mechanical damage.	Oscillation frequency: 10 Hz to 55 Hz to 10 Hz, for approx. 1 min Total amplitude: 1.5 mm Test time: 3 directions perpendicular to each other, 2 h for each direction (6 h in total)

Reference Only

Spec No.: JELF243A_0090M-01

P8/16

No.	Item	Specification	Test method
8.3	Solderability	90% or more of the outer electrode shall be covered with new solder seamlessly.	Flux: immersed in ethanol solution [including an activator with a chlorine conversion value of 0.06(wt)%] with a rosin content of 25(wt)% for 5 s to 10 s. Solder: Sn-3.0Ag-0.5Cu solder Pre-heating: 150°C±10°C/60 s to 90 s Solder temperature: 240°C±5°C Immersion time: 4 s±1 s
8.4	Resistance to soldering heat	Appearance: No significant mechanical damage shall be observed. Inductance change rate: within ±5%	Flux: immersed in ethanol solution [including an activator with a chlorine conversion value of 0.06(wt)%] with a rosin content of 25(wt)% for 5 s to 10 s. Solder: Sn-3.0Ag-0.5Cu solder Pre-heating: 150°C±10°C/60 s to 90 s Solder temperature: 270°C±5°C Immersion time: 5 s±1 s Post-treatment: left at a room condition for 24 h±2 h

9. Environmental Performance

The product is soldered on a substrate for test.

No.	Item	Specification	Test method
9.1	Heat resistance	Appearance: No significant mechanical damage shall be observed. Inductance change rate: within ±5% Q change rate: within ±20%	Temperature: 125°C±2°C Test time: 1000 h (+48 h, -0 h) Post-treatment: left at a room condition for 24 h±2 h
9.2	Cold resistance	Appearance: No significant mechanical damage shall be observed. Inductance change rate: within ±5% Q change rate: within ±20%	Temperature: -55°C±2°C Test time: 1000 h (+48 h, -0 h) Post-treatment: left at a room condition for 24 h±2 h
9.3	Humidity	Appearance: No significant mechanical damage shall be observed. Inductance change rate: within ±5% Q change rate: within ±20%	Temperature: 70°C±2°C Humidity: 90% (RH) to 95% (RH) Test time: 1000 h (+48 h, -0 h) Post-treatment: left at a room condition for 24 h±2 h
9.4	Temperature cycle	Appearance: No significant mechanical damage shall be observed. Inductance change rate: within ±5% Q change rate: within ±20%	Single cycle conditions: Step 1: -55°C±2°C/30 min±3 min Step 2: ordinary temperature/10 min to 15 min Step 3: +125°C±2°C/30 min±3 min Step 4: ordinary temperature/10 min to 15 min Number of testing: 10 cycles Post-treatment: left at a room condition for 24 h±2 h

10. Specification of Packaging

10.1 Appearance and dimensions of tape (8 mm width/paper tape)

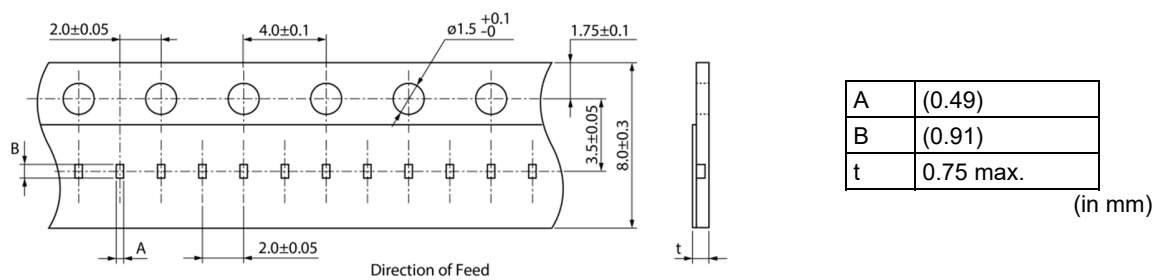

10.2 Taping specifications

Packing quantity (Standard quantity)	10000 pcs/reel
Packing method	The products are placed in embossed cavities of a base tape and sealed by a cover tape.
Feed hole position	The feed holes on the base tape are on the right side when the cover tape is pulled toward the user.
Joint	The base tape and the cover tape are seamless.
Number of missing products	Number of missing products within 0.025% of the number per reel or 1 pc., whichever is greater, and are not continuous. The specified quantity per reel is kept.

Reference Only

Spec No.: JELF243A_0090M-01

P9/16

10.3 Break down force of tape

Break down force of cover tape	5 N min.
--------------------------------	----------

10.4 Peeling off force of cover tape

Speed of peeling off	300 mm/min
Peeling off force	0.1 N to 0.6 N (The lower limit is for typical value.)

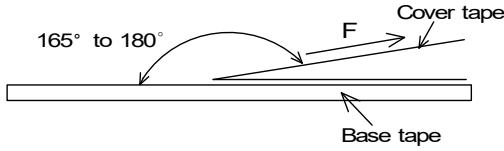

10.5 Dimensions of leader section, trailer section and reel

A vacant section is provided in the leader (start) section and trailer (end) section of the tape for the product. The leader section is further provided with an area consisting only of the cover tape (or top tape). (See the diagram below.)

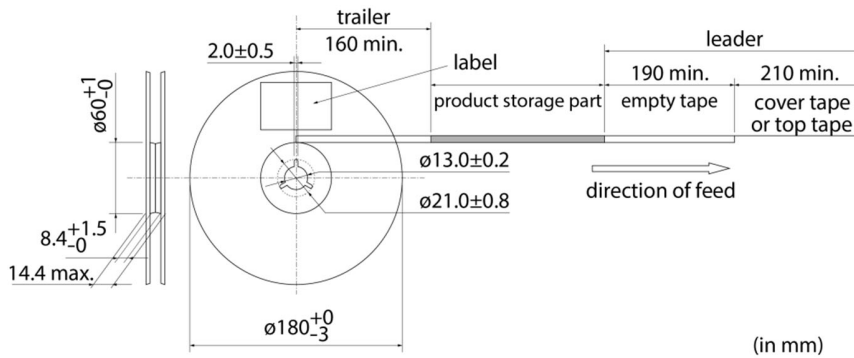

10.6 Marking for reel

Customer part number, Murata part number, inspection number (*1), RoHS marking (*2), quantity, etc.

<p>*1 Expression of inspection No.:</p> <table style="margin-left: 20px;"> <tr> <td style="border: 1px solid black; padding: 2px;">□□</td> <td style="border: 1px solid black; padding: 2px;">○○○○</td> <td style="border: 1px solid black; padding: 2px;">◇◇◇◇</td> </tr> <tr> <td style="text-align: center;">(1)</td> <td style="text-align: center;">(2)</td> <td style="text-align: center;">(3)</td> </tr> </table>	□□	○○○○	◇◇◇◇	(1)	(2)	(3)	<p>(1) Factory code (2) Date First digit: year/last digit of year Second digit: month/Jan. to Sep. → 1 to 9, Oct. to Dec. → O, N, D Third, Fourth digit: day (3) Serial No.</p>
□□	○○○○	◇◇◇◇					
(1)	(2)	(3)					
<p>*2 Expression of RoHS marking:</p> <table style="margin-left: 20px;"> <tr> <td style="border: 1px solid black; padding: 2px;">ROHS-</td> <td style="border: 1px solid black; padding: 2px;">Y</td> <td style="border: 1px solid black; padding: 2px;">(△)</td> </tr> <tr> <td></td> <td style="text-align: center;">(1)</td> <td style="text-align: center;">(2)</td> </tr> </table>	ROHS-	Y	(△)		(1)	(2)	<p>(1) RoHS regulation conformity (2) Murata classification number</p>
ROHS-	Y	(△)					
	(1)	(2)					

10.7 Marking on outer box (corrugated box)

Customer name, purchasing order number, customer part number, Murata part number, RoHS marking (*2), quantity, etc.

10.8 Specification of outer box

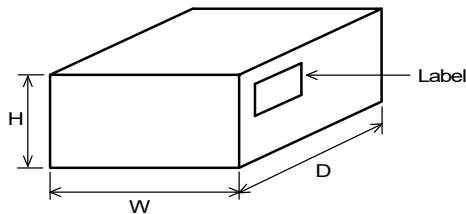

Dimensions of outer box (mm)			Standard reel quantity in outer box (reel)
W	D	H	
186	186	93	5
* Above outer box size is typical. It depends on a quantity of an order.			

11. ⚠Caution**11.1 Limitation of applications**

The products listed in the reference specification (hereinafter the product(s) is called as the "Product(s)") are designed and manufactured for applications specified in the reference specification (hereinafter called as the "Specific Application"). We shall not warrant anything in connection with the Products including fitness, performance, adequateness, safety, or quality, in the case of applications listed in from (1) to (11) written at the end of this precautions, which may generally require high performance, function, quality, management of production or safety. Therefore, the Product shall be applied in compliance with the specific application.

WE DISCLAIM ANY LOSS AND DAMAGES ARISING FROM OR IN CONNECTION WITH THE PRODUCTS INCLUDING BUT NOT LIMITED TO THE CASE SUCH LOSS AND DAMAGES CAUSED BY THE UNEXPECTED ACCIDENT, IN EVENT THAT (i) THE PRODUCT IS APPLIED FOR THE PURPOSE WHICH IS NOT SPECIFIED AS THE SPECIFIC APPLICATION FOR THE PRODUCT, AND/OR (ii) THE PRODUCT IS APPLIED FOR ANY FOLLOWING APPLICATION PURPOSES FROM (1) TO (11) (EXCEPT THAT SUCH APPLICATION PURPOSE IS UNAMBIGUOUSLY SPECIFIED AS SPECIFIC APPLICATION FOR THE PRODUCT IN OUR CATALOG SPECIFICATION FORMS, DATASHEETS, OR OTHER DOCUMENTS OFFICIALLY ISSUED BY US*).

- (1) Aircraft equipment
- (2) Aerospace equipment
- (3) Undersea equipment
- (4) Power plant control equipment
- (5) Medical equipment
- (6) Transportation equipment
- (7) Traffic control equipment
- (8) Disaster prevention/security equipment
- (9) Industrial data-processing equipment
- (10) Combustion/explosion control equipment
- (11) Equipment with complexity and/or required reliability equivalent to the applications listed in the above.

For exploring information of the Products which will be compatible with the particular purpose other than those specified in the reference specification, please contact our sales offices, distribution agents, or trading companies with which you make a deal, or via our web contact form.

Contact form: <https://www.murata.com/contactform>

* We may design and manufacture particular Products for applications listed in (1) to (11). Provided that, in such case we shall unambiguously specify such Specific Application in the reference specification without any exception. Therefore, any other documents and/or performances, whether exist or non-exist, shall not be deemed as the evidence to imply that we accept the applications listed in (1) to (11).

11.2 Precautions on rating

Avoid using in exceeded the rated temperature range, rated voltage, or rated current.

Usage when the ratings are exceeded could lead to wire breakage, burning, or other serious fault.

11.3 Inrush current

If an inrush current (or pulse current or rush current) that significantly exceeds the rated current is applied to the product, overheating could occur, resulting in wire breakage, burning, or other serious fault.

11.4 Corrosive gas

Please refrain from use since contact with environments with corrosive gases (sulfur gas [hydrogen sulfide, sulfur dioxide, etc.], chlorine, ammonia, etc.) or oils (cutting oil, silicone oil, etc.) that have come into contact with the previously stated corrosive gas environment will result in deterioration of product quality or an open from deterioration due to corrosion of product electrode, etc. We will not bear any responsibility for use under these environments.

12. Precautions for Use

This product is for use only with reflow soldering. It is designed to be mounted by soldering. If you want to use other mounting method, for example, using a conductive adhesive, please consult us beforehand.

Also, if repeatedly subjected to temperature cycles or other thermal stress, due to the difference in the coefficient of thermal expansion with the mounting substrate, the solder (solder fillet part) in the mounting part may crack.

The occurrence of cracks due to thermal stress is affected by the size of the land where mounted, the solder volume, and the heat dissipation of the mounting substrate. Carefully design it when a large change in ambient temperature is assumed.

12.1 Land dimensions

The following diagram shows the recommended land dimensions for reflow soldering.

The land dimensions are designed in consideration of electrical characteristics and mountability. Use of other land dimensions may preclude achievement of performance. In some cases, it may result in poor solderability, including positional shift. If you use other land pattern, consider it adequately.

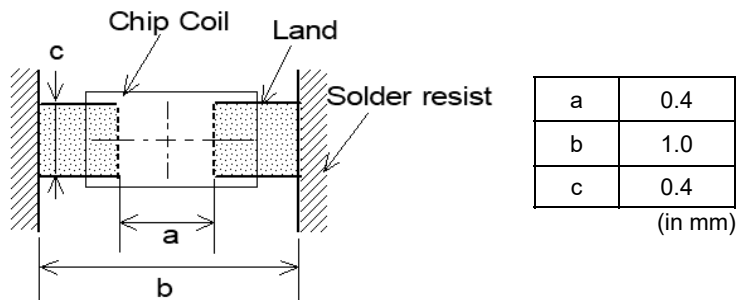

12.2 Flux and solder used

Flux	<ul style="list-style-type: none"> • Use a rosin-based flux that includes an activator with a chlorine conversion value of 0.06 mass% to 0.1 mass%. • Do not use a highly acidic flux with a halide content exceeding 0.2 mass% (chlorine conversion value). • Do not use a water-soluble flux.
Solder	<ul style="list-style-type: none"> • Use Sn-3.0Ag-0.5Cu solder. • Standard thickness of solder paste: 80 μm to 100 μm

If you want to use a flux other than the above, please consult our technical department.

Reference Only

Spec No.: JELF243A_0090M-01

P12/16

12.3 Soldering conditions (reflow)

- Pre-heating should be in such a way that the temperature difference between solder and product surface is limited to 150°C max.
Cooling into solvent after soldering also should be in such a way that the temperature difference is limited to 100°C max. Insufficient pre-heating may cause cracks on the product, resulting in the deterioration of product quality.
- Standard soldering profile and the limit soldering profile is as follows.
The excessive limit soldering conditions may cause leaching of the electrode and/or resulting in the deterioration of product quality.

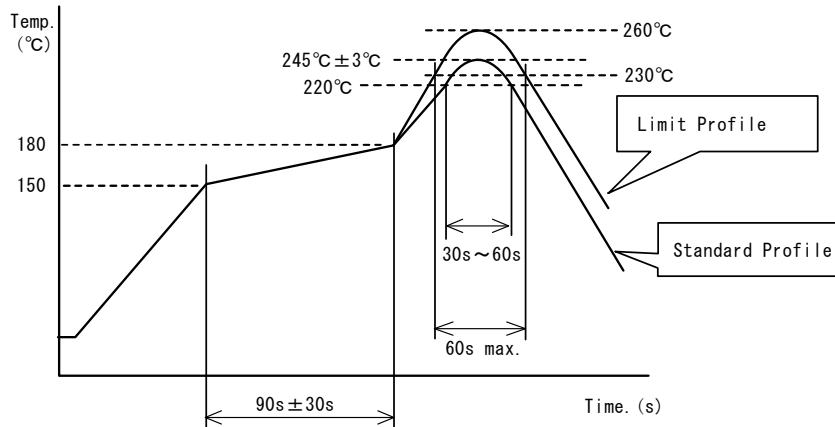

	Standard profile	Limit profile
Pre-heating	150°C to 180°C/90 s ± 30 s	150°C to 180°C/90 s ± 30 s
Heating	Above 220°C/30 s to 60 s	Above 230°C/60 s max.
Peak temperature	245°C ± 3°C	260°C/10 s
Number of reflow cycles	2 times	2 times

12.4 Reworking with soldering iron

Do not perform reworking with a soldering iron on this product.

12.5 Solder volume

Solder shall be used not to increase the volume too much.

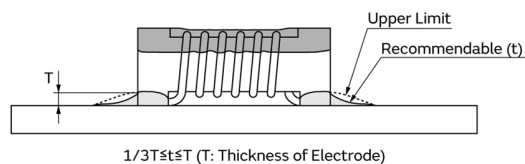

An increased solder volume increases mechanical stress on the product. Exceeding solder volume may cause the failure of mechanical or electrical performance.

12.6 Product's location

The following shall be considered when designing and laying out PCBs.

- PCB shall be designed so that products are not subject to mechanical stress due to warping the board.

[Products direction]

Products shall be located in the sideways direction (length: $a < b$) to the mechanical stress.

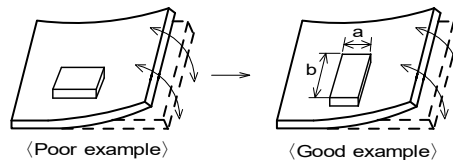

(2) Components location on PCB separation

It is effective to implement the following measures, to reduce stress in separating the board.

It is best to implement all of the following three measures; however, implement as many measures as possible to reduce stress.

Contents of measures	Stress level
(1) Turn the mounting direction of the component parallel to the board separation surface.	$A > D^{*1}$
(2) Add slits in the board separation part.	$A > B$
(3) Keep the mounting position of the component away from the board separation surface.	$A > C$
*1 $A > D$ is valid when stress is added vertically to the perforation as with hand separation. If a cutting disc is used, stress will be diagonal to the PCB, therefore $A > D$ is invalid.	

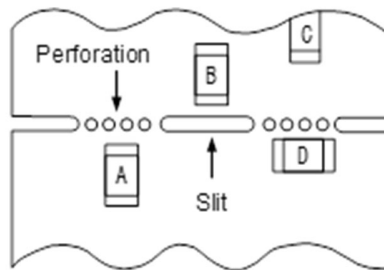

(3) Mounting components near screw holes

When a component is mounted near a screw hole, it may be affected by the board deflection that occurs during the tightening of the screw.

Mount the component in a position as far away from the screw holes as possible.

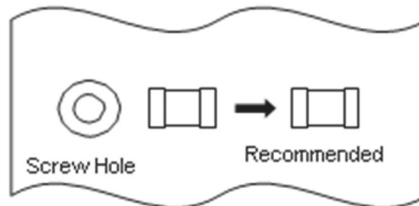
**12.7 Handling of substrate**

After mounting products on a substrate, do not apply any stress to the product caused by bending or twisting to the substrate when cropping the substrate, inserting and removing a connector from the substrate or tightening screw to the substrate. Excessive mechanical stress may cause cracking in the product.

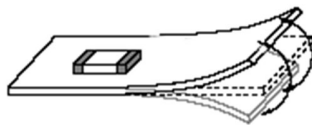

Bending

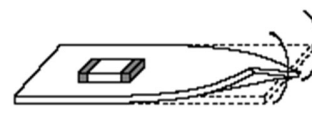

Twisting

12.8 Cleaning

The product shall be cleaned under the following conditions.

- (1) The cleaning temperature shall be 60°C max. If isopropyl alcohol (IPA) is used, the cleaning temperature shall be 40°C max.
- (2) Perform ultrasonic cleaning under the following conditions. Exercise caution to prevent resonance phenomenon in mounted products and the PCB.

Item	Requirement
Power	20 W/L max.
Time	5 min max.
Frequency	28 kHz to 40 kHz

- (3) Cleaner

Alcohol-based cleaner: IPA

Aqueous agent: PINE ALPHA ST-100S

- (4) There shall be no residual flux or residual cleaner. When using aqueous agent, rinse the product with deionized water adequately and completely dry it so that no cleaner is left.

* For other cleaning, consult our technical department.

12.9 Storage and transportation

Storage period	Use the product within 12 months after delivery. If you do not use the product for more than 12 months, check solderability before using it.
Storage conditions	<ul style="list-style-type: none"> • The products shall be stored in a room not subject to rapid changes in temperature and humidity. The recommended temperature range is -10°C to +40°C. The recommended relative humidity range is 15% to 85%. Keeping the product in corrosive gases, such as sulfur, chlorine gas or acid may cause the poor solderability. • Do not place the products directly on the floor; they should be placed on a palette so that they are not affected by humidity or dust. • Avoid keeping the products in a place exposed to direct sunlight, heat or vibration. • Do not keep products in bulk packaging. Bulk storage could result in collisions between the products or between the products and other parts, resulting in chipping or wire breakage. • Avoid storing the product by itself bare (i.e. exposed directly to air).
Transportation	Excessive vibration and impact reduces the reliability of the products. Exercise caution when handling the products.

12.10 Resin coating (including moisture-proof coating)

When the product is coated/molded with resin, its electrical characteristics may change.

A wire breakage issue may occur by mechanical stress caused by the resin, amount/cured shape of resin, or operating condition etc.

Some resins contain impurities or hydrolyzable chlorine, which could result in corrosion of the conducting materials, leading to wire breakage.

So, please pay your careful attention when you select resin in case of coating/molding the products with the resin.

Prior to use the coating resin, please make sure no reliability issue is observed by evaluating products mounted on your board.

12.11 Mounting conditions

Check the mounting condition before using.

Using mounting conditions (nozzles, equipment conditions, etc.) that are not suitable for products may lead to pick up errors, misalignment, or damage to the product.

With some types of mounting equipment, a support pin pushes up the product from the bottom of the base (paper) tape when the product is sucked with the pick-up nozzle. When using this type of equipment, detach the support pin to prevent the breaking of wire on the product.

In some cases, the laser recognition function of the mounting equipment may not recognize this product correctly.

Please contact us when using laser recognition. (There is no problem with the permeation and reflection type.)

12.12 Operating environment

Do not use this product under the following environmental conditions as it may cause deterioration of product quality.

- (1) In the corrodible atmosphere such as acidic gases, alkaline gases, chlorine, sulfur gases, organic gases and etc. (the sea breeze, Cl₂, H₂S, NH₃, SO₂, NO₂, etc)
- (2) In the atmosphere where liquid such as organic solvent, may splash on the products.
- (3) In the atmosphere where the temperature/humidity changes rapidly and it is easy to dew.

Reference Only

Spec No.: JELF243A_0090M-01

P15/16

12.13 Mounting density

If this product is placed near heat-generating products, be sure to implement sufficient heat-dissipating measures.

If this product is subjected to a significant amount of heat from other products, this could adversely affect product quality, resulting in a circuit malfunction or failure of the mounted section. Also, be sure that the product is used in a manner so that the heat that the product is subjected to from other products does not exceed the upper limit of the rated operating temperature for the product.

12.14 Handling of product

- To prevent wire breakage, sharp objects such as tweezers, bristles of cleaning brushes, and other objects must not contact the winding section or the electrode section.
- Mechanical shock should not be applied to the products mounted on the board to prevent the breaking of the core.

13.  Note

- (1) Please make sure that your product has been evaluated in view of your specifications with our product being mounted to your product.
- (2) You are requested not to use our product deviating from the reference specifications.
- (3) The contents of this reference specification are subject to change without advance notice. Please approve our product specifications or transact the approval sheet for product specifications before ordering.

14. Appendix

Electrical performance: Measuring method for inductance/Q (Q measurement is applicable only when the Q value is included in the rating table.)

Perform measurement using the method described below. (Perform correction for the error deriving from the measuring terminal.)

(1) Residual elements and stray elements of the measuring terminal can be expressed by the F parameter for the 2-pole terminal as shown in the figure below.

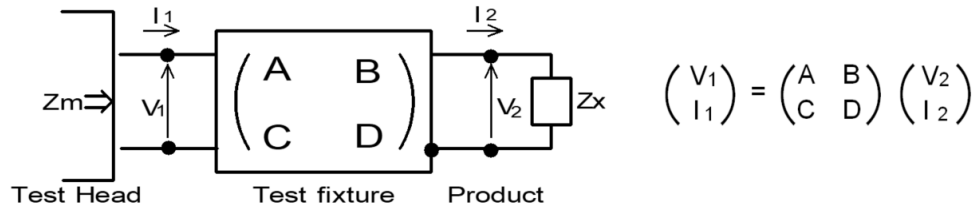

(2) The product's impedance value (Z_x) and measured impedance value (Z_m) can be expressed as shown below, by using the respective current and voltage for input/output.

$$Z_m = \frac{V_1}{I_1} \quad Z_x = \frac{V_2}{I_2}$$

(3) Thus, the relationship between the product's impedance value (Z_x) and measured impedance value (Z_m) is as follows.

$Z_x = \alpha \frac{Z_m - \beta}{1 - Z_m \Gamma}$	<p>Here,</p> <p>$\alpha = D/A = 1$</p> <p>$\beta = B/D = Z_{sm} - (1 - Y_{om} Z_{sm}) Z_{ss}$</p> <p>$\Gamma = C/A = Y_{om}$</p> <p>$Z_{sm}$: measured impedance of short chip</p> <p>Z_{ss}: residual impedance of short chip (0.464 nH)</p> <p>Y_{om}: measured admittance when measuring terminal is open</p>
---	--

(4) Calculate inductance L_x and Q_x using the equations shown below.

$L_x = \frac{\text{Im}(Z_x)}{2\pi f}$	<p>L_x: inductance of chip coil</p>
$Q_x = \frac{\text{Im}(Z_x)}{\text{Re}(Z_x)}$	<p>Q_x: Q of chip coil</p> <p>f: measuring frequency</p>

OUR CERTIFICATE

DiGi provide top-quality products and perfect service for customer worldwide through standardization, technological innovation and continuous improvement. DiGi through third-party certification, we stricly control the quality of products and services. Welcome your RFQ to

Email: Info@DiGi-Electronics.com



Tel: +00 852-30501935

RFQ Email: Info@DiGi-Electronics.com

DiGi is a global authorized distributor of electronic components.