

LQW18ANR20J80D Datasheet

www.digi-electronics.com



<https://www.DiGi-Electronics.com>

DiGi Electronics Part Number	LQW18ANR20J80D-DG
Manufacturer	Murata Electronics
Manufacturer Product Number	LQW18ANR20J80D
Description	FIXED IND 200NH 290MA 1.74OHM SM
Detailed Description	200 nH Unshielded Drum Core, Wirewound Inductor 290 mA 1.74Ohm Max 0603 (1608 Metric)



Tel: +00 852-30501935

RFQ Email: Info@DiGi-Electronics.com

DiGi is a global authorized distributor of electronic components.

Purchase and inquiry

Manufacturer Product Number:

LQW18ANR20J80D

Series:

LQW18

Type:

Drum Core, Wirewound

Inductance:

200 nH

Current Rating (Amps):

290 mA

Shielding:

Unshielded

Q @ Freq:

25 @ 100MHz

Ratings:

-

Inductance Frequency - Test:

100 MHz

Mounting Type:

Surface Mount

Supplier Device Package:

-

Height - Seated (Max):

0.039" (1.00mm)

Manufacturer:

Murata Electronics

Product Status:

Active

Material - Core:

Non-Magnetic

Tolerance:

±5%

Current - Saturation (Isat):

-

DC Resistance (DCR):

1.740hm Max

Frequency - Self Resonant:

1.35GHz

Operating Temperature:

-55°C ~ 125°C

Features:

-

Package / Case:

0603 (1608 Metric)

Size / Dimension:

0.065" L x 0.039" W (1.65mm x 0.99mm)

Base Product Number:

LQW18AN

Environmental & Export classification

RoHS Status:

ROHS3 Compliant

REACH Status:

REACH Unaffected

HTSUS:

8504.50.8000

Moisture Sensitivity Level (MSL):

1 (Unlimited)

ECCN:

EAR99

CHIP COIL (CHIP INDUCTOR) for Consumer equipment & Industrial equipment LQW18AN□□□□80□ REFERENCE SPECIFICATION

1. Scope

This reference specification applies to chip coil (chip inductor) LQW18AN_80 series.

1.1 Specific applications:

- Power equipment: Products that can be used in power equipment such as renewable energy equipment, energy storage equipment and EV charging equipment and whose functions are not directly related to the protection of human life and property.
- Industrial equipment: Products that can be used in industrial equipment such as base stations, manufacturing equipment, industrial robotics equipment, and measurement equipment, and whose functions do not directly relate to the protection of human life and property.
- Medical equipment (GHTF Class C) *Except for implant/surgery/auto injector: Products that can be used for medical equipment of Class C of the international classification class GHTF and whose malfunction is considered to pose a relatively high risk to the human body.
- Medical equipment (GHTF Class A and B): Products that can be used for medical equipment regulated by Class A and Class B of the international classification class GHTF and whose functions do not directly relate to the protection of human life and property.
- Consumer equipment: Products that can be used in consumer equipment such as home appliances, audio/visual equipment, communication equipment, information equipment, office equipment, and household robotics, and whose functions are not directly related to the protection of human life and property.

1.2 Unsuitable application:

Applications listed in "Limitation of applications" in this reference specification.

2. Part Numbering

(Ex.)

LQ	W	18	A	N	2N2	C	8	0	D
Product ID	Structure	Dimension (L × W)	Application and characteristic	Category	Inductance	Tolerance	Performance	Electrode specification	Packaging D: taping *B: bulk

*B: Bulk packing is also available (taping condition: however, products without reels are put in plastic bags).

3. Part Number and Rating

Operating temperature range	-55°C to +125°C
Storage temperature range	-55°C to +125°C

Customer Part number	Murata Part number	Inductance		Q (Min.)	DC resistance (Ω max.)	Self-resonant frequency (MHz min.)	Rated current (mA) ^{*1}
		Nominal value (nH)	Tolerance				
	LQW18AN2N2C80D	2.2	C: ±0.2 nH	24	0.018	15000	3200
	LQW18AN2N4C80D	2.4	C: ±0.2 nH	18	0.026	15000	2400
	LQW18AN3N0C80D	3.0	C: ±0.2 nH	13	0.17	15000	670
	LQW18AN3N9B80D	3.9	B: ±0.1 nH	30	0.028	10000	2200
	LQW18AN3N9C80D	3.9	C: ±0.2 nH	30	0.028	10000	2200
	LQW18AN3N9G80D	3.9	G: ±2%	30	0.028	10000	2200
	LQW18AN4N1B80D	4.1	B: ±0.1 nH	30	0.028	10000	2200
	LQW18AN4N1C80D	4.1	C: ±0.2 nH	30	0.028	10000	2200
	LQW18AN4N1G80D	4.1	G: ±2%	30	0.028	10000	2200
	LQW18AN4N2B80D	4.2	B: ±0.1 nH	30	0.028	10000	2200
	LQW18AN4N2C80D	4.2	C: ±0.2 nH	30	0.028	10000	2200
	LQW18AN4N2G80D	4.2	G: ±2%	30	0.028	10000	2200
	LQW18AN4N3B80D	4.3	B: ±0.1 nH	35	0.036	11600	2100
	LQW18AN4N3C80D	4.3	C: ±0.2 nH	35	0.036	11600	2100
	LQW18AN4N3G80D	4.3	G: ±2%	35	0.036	11600	2100

Customer Part number	Murata Part number	Inductance		Q (Min.)	DC resistance (Ω max.)	Self-resonant frequency (MHz min.)	Rated current (mA) ^{*1}
		Nominal value (nH)	Tolerance				
	LQW18AN4N7B80D	4.7	B: ± 0.1 nH	25	0.054	10400	1500
	LQW18AN4N7C80D	4.7	C: ± 0.2 nH	25	0.054	10400	1500
	LQW18AN4N7G80D	4.7	G: $\pm 2\%$	25	0.054	10400	1500
	LQW18AN4N9B80D	4.9	B: ± 0.1 nH	23	0.081	7300	1200
	LQW18AN4N9C80D	4.9	C: ± 0.2 nH	23	0.081	7300	1200
	LQW18AN4N9G80D	4.9	G: $\pm 2\%$	23	0.081	7300	1200
	LQW18AN5N6C80D	5.6	C: ± 0.2 nH	38	0.040	6650	1900
	LQW18AN5N6G80D	5.6	G: $\pm 2\%$	38	0.040	6650	1900
	LQW18AN6N0C80D	6	C: ± 0.2 nH	40	0.040	6650	1900
	LQW18AN6N0G80D	6	G: $\pm 2\%$	40	0.040	6650	1900
	LQW18AN6N5C80D	6.5	C: ± 0.2 nH	40	0.040	6650	1900
	LQW18AN6N5G80D	6.5	G: $\pm 2\%$	40	0.040	6650	1900
	LQW18AN6N8C80D	6.8	C: ± 0.2 nH	40	0.040	6650	1900
	LQW18AN6N8G80D	6.8	G: $\pm 2\%$	40	0.040	6650	1900
	LQW18AN7N2C80D	7.2	C: ± 0.2 nH	38	0.040	6650	1900
	LQW18AN7N2G80D	7.2	G: $\pm 2\%$	38	0.040	6650	1900
	LQW18AN7N5C80D	7.5	C: ± 0.2 nH	35	0.048	7000	1500
	LQW18AN7N5G80D	7.5	G: $\pm 2\%$	35	0.048	7000	1500
	LQW18AN8N2C80D	8.2	C: ± 0.2 nH	38	0.052	4750	1600
	LQW18AN8N2G80D	8.2	G: $\pm 2\%$	38	0.052	4750	1600
	LQW18AN8N4C80D	8.4	C: ± 0.2 nH	38	0.052	4750	1600
	LQW18AN8N4G80D	8.4	G: $\pm 2\%$	38	0.052	4750	1600
	LQW18AN8N7C80D	8.7	C: ± 0.2 nH	38	0.052	4750	1600
	LQW18AN8N7G80D	8.7	G: $\pm 2\%$	38	0.052	4750	1600
	LQW18AN9N1C80D	9.1	C: ± 0.2 nH	38	0.052	4750	1600
	LQW18AN9N1G80D	9.1	G: $\pm 2\%$	38	0.052	4750	1600
	LQW18AN9N5C80D	9.5	C: ± 0.2 nH	38	0.052	4750	1600
	LQW18AN9N5G80D	9.5	G: $\pm 2\%$	38	0.052	4750	1600
	LQW18AN9N9C80D	9.9	C: ± 0.2 nH	38	0.052	4750	1600
	LQW18AN9N9G80D	9.9	G: $\pm 2\%$	38	0.052	4750	1600
	LQW18AN10NG80D	10	G: $\pm 2\%$	38	0.052	4750	1600
	LQW18AN10NJ80D	10	J: $\pm 5\%$	38	0.052	4750	1600
	LQW18AN11NG80D	11	G: $\pm 2\%$	40	0.052	4750	1600
	LQW18AN11NJ80D	11	J: $\pm 5\%$	40	0.052	4750	1600
	LQW18AN12NG80D	12	G: $\pm 2\%$	37	0.064	5000	1500
	LQW18AN12NJ80D	12	J: $\pm 5\%$	37	0.064	5000	1500
	LQW18AN13NG80D	13	G: $\pm 2\%$	37	0.064	5000	1500
	LQW18AN13NJ80D	13	J: $\pm 5\%$	37	0.064	5000	1500
	LQW18AN15NG80D	15	G: $\pm 2\%$	38	0.075	4600	1400
	LQW18AN15NJ80D	15	J: $\pm 5\%$	38	0.075	4600	1400
	LQW18AN16NG80D	16	G: $\pm 2\%$	40	0.075	4600	1400
	LQW18AN16NJ80D	16	J: $\pm 5\%$	40	0.075	4600	1400
	LQW18AN17NG80D	17	G: $\pm 2\%$	40	0.075	4600	1400
	LQW18AN17NJ80D	17	J: $\pm 5\%$	40	0.075	4600	1400
	LQW18AN18NG80D	18	G: $\pm 2\%$	40	0.075	4600	1400
	LQW18AN18NJ80D	18	J: $\pm 5\%$	40	0.075	4600	1400

Customer Part number	Murata Part number	Inductance		Q (Min.)	DC resistance (Ω max.)	Self-resonant frequency (MHz min.)	Rated current (mA) ^{*1}
		Nominal value (nH)	Tolerance				
	LQW18AN19NG80D	19	G: $\pm 2\%$	40	0.075	4600	1400
	LQW18AN19NJ80D	19	J: $\pm 5\%$	40	0.075	4600	1400
	LQW18AN22NG80D	22	G: $\pm 2\%$	40	0.086	3450	1300
	LQW18AN22NJ80D	22	J: $\pm 5\%$	40	0.086	3450	1300
	LQW18AN23NG80D	23	G: $\pm 2\%$	40	0.086	3450	1300
	LQW18AN23NJ80D	23	J: $\pm 5\%$	40	0.086	3450	1300
	LQW18AN24NG80D	24	G: $\pm 2\%$	40	0.086	3450	1300
	LQW18AN24NJ80D	24	J: $\pm 5\%$	40	0.086	3450	1300
	LQW18AN25NG80D	25	G: $\pm 2\%$	40	0.098	3600	1200
	LQW18AN25NJ80D	25	J: $\pm 5\%$	40	0.098	3600	1200
	LQW18AN27NG80D	27	G: $\pm 2\%$	40	0.098	3600	1200
	LQW18AN27NJ80D	27	J: $\pm 5\%$	40	0.098	3600	1200
	LQW18AN28NG80D	28	G: $\pm 2\%$	40	0.098	3600	1200
	LQW18AN28NJ80D	28	J: $\pm 5\%$	40	0.098	3600	1200
	LQW18AN30NG80D	30	G: $\pm 2\%$	40	0.12	2880	1100
	LQW18AN30NJ80D	30	J: $\pm 5\%$	40	0.12	2880	1100
	LQW18AN31NG80D	31	G: $\pm 2\%$	40	0.11	3150	1100
	LQW18AN31NJ80D	31	J: $\pm 5\%$	40	0.11	3150	1100
	LQW18AN33NG80D	33	G: $\pm 2\%$	40	0.11	3150	1100
	LQW18AN33NJ80D	33	J: $\pm 5\%$	40	0.11	3150	1100
	LQW18AN34NG80D	34	G: $\pm 2\%$	40	0.15	3000	1050
	LQW18AN34NJ80D	34	J: $\pm 5\%$	40	0.15	3000	1050
	LQW18AN36NG80D	36	G: $\pm 2\%$	37	0.20	3000	910
	LQW18AN36NJ80D	36	J: $\pm 5\%$	37	0.20	3000	910
	LQW18AN37NG80D	37	G: $\pm 2\%$	37	0.20	3000	910
	LQW18AN37NJ80D	37	J: $\pm 5\%$	37	0.20	3000	910
	LQW18AN39NG80D	39	G: $\pm 2\%$	40	0.16	3280	1000
	LQW18AN39NJ80D	39	J: $\pm 5\%$	40	0.16	3280	1000
	LQW18AN41NG80D	41	G: $\pm 2\%$	40	0.16	3280	1000
	LQW18AN41NJ80D	41	J: $\pm 5\%$	40	0.16	3280	1000
	LQW18AN43NG80D	43	G: $\pm 2\%$	40	0.21	2780	840
	LQW18AN43NJ80D	43	J: $\pm 5\%$	40	0.21	2780	840
	LQW18AN44NG80D	44	G: $\pm 2\%$	40	0.21	2780	840
	LQW18AN44NJ80D	44	J: $\pm 5\%$	40	0.21	2780	840
	LQW18AN47NG80D	47	G: $\pm 2\%$	32	0.23	2700	830
	LQW18AN47NJ80D	47	J: $\pm 5\%$	32	0.23	2700	830
	LQW18AN48NG80D	48	G: $\pm 2\%$	32	0.23	2700	830
	LQW18AN48NJ80D	48	J: $\pm 5\%$	32	0.23	2700	830
	LQW18AN51NG80D	51	G: $\pm 2\%$	32	0.23	2700	830
	LQW18AN51NJ80D	51	J: $\pm 5\%$	32	0.23	2700	830
	LQW18AN52NG80D	52	G: $\pm 2\%$	35	0.27	2750	750
	LQW18AN52NJ80D	52	J: $\pm 5\%$	35	0.27	2750	750
	LQW18AN56NG80D	56	G: $\pm 2\%$	38	0.26	2600	770
	LQW18AN56NJ80D	56	J: $\pm 5\%$	38	0.26	2600	770
	LQW18AN58NG80D	58	G: $\pm 2\%$	35	0.30	2400	700
	LQW18AN58NJ80D	58	J: $\pm 5\%$	35	0.30	2400	700

Customer Part number	Murata Part number	Inductance		Q (Min.)	DC resistance (Ω max.)	Self-resonant frequency (MHz min.)	Rated current (mA) ^{*1}
		Nominal value (nH)	Tolerance				
	LQW18AN68NG80D	68	G: $\pm 2\%$	37	0.38	2380	630
	LQW18AN68NJ80D	68	J: $\pm 5\%$	37	0.38	2380	630
	LQW18AN69NG80D	69	G: $\pm 2\%$	37	0.38	2380	630
	LQW18AN69NJ80D	69	J: $\pm 5\%$	37	0.38	2380	630
	LQW18AN72NG80D	72	G: $\pm 2\%$	34	0.47	2330	560
	LQW18AN72NJ80D	72	J: $\pm 5\%$	34	0.47	2330	560
	LQW18AN73NG80D	73	G: $\pm 2\%$	28	0.41	2280	590
	LQW18AN73NJ80D	73	J: $\pm 5\%$	28	0.41	2280	590
	LQW18AN75NG80D	75	G: $\pm 2\%$	28	0.41	2280	590
	LQW18AN75NJ80D	75	J: $\pm 5\%$	28	0.41	2280	590
	LQW18AN78NG80D	78	G: $\pm 2\%$	28	0.41	2280	590
	LQW18AN78NJ80D	78	J: $\pm 5\%$	28	0.41	2280	590
	LQW18AN82NG80D	82	G: $\pm 2\%$	34	0.5	2230	550
	LQW18AN82NJ80D	82	J: $\pm 5\%$	34	0.5	2230	550
	LQW18AN83NG80D	83	G: $\pm 2\%$	34	0.5	2230	550
	LQW18AN83NJ80D	83	J: $\pm 5\%$	34	0.5	2230	550
	LQW18AN91NG80D	91	G: $\pm 2\%$	33	0.54	1900	520
	LQW18AN91NJ80D	91	J: $\pm 5\%$	33	0.54	1900	520
	LQW18AN94NG80D	94	G: $\pm 2\%$	34	0.63	1750	490
	LQW18AN94NJ80D	94	J: $\pm 5\%$	34	0.63	1750	490
	LQW18ANR10G80D	100	G: $\pm 2\%$	34	0.63	1750	490
	LQW18ANR10J80D	100	J: $\pm 5\%$	34	0.63	1750	490
	LQW18ANR11G80D	110	G: $\pm 2\%$	32	0.7	1730	450
	LQW18ANR11J80D	110	J: $\pm 5\%$	32	0.7	1730	450
	LQW18ANR12G80D	120	G: $\pm 2\%$	32	0.72	1650	450
	LQW18ANR12J80D	120	J: $\pm 5\%$	32	0.72	1650	450
	LQW18ANR15G80D	150	G: $\pm 2\%$	28	0.87	1580	420
	LQW18ANR15J80D	150	J: $\pm 5\%$	28	0.87	1580	420
	LQW18ANR18G80D	180	G: $\pm 2\%$	25	1.65	1380	310
	LQW18ANR18J80D	180	J: $\pm 5\%$	25	1.65	1380	310
	LQW18ANR20G80D	200	G: $\pm 2\%$	25	1.74	1350	290
	LQW18ANR20J80D	200	J: $\pm 5\%$	25	1.74	1350	290
	LQW18ANR21G80D	210	G: $\pm 2\%$	27	1.98	1330	280
	LQW18ANR21J80D	210	J: $\pm 5\%$	27	1.98	1330	280
	LQW18ANR22G80D	220	G: $\pm 2\%$	25	2.08	1330	280
	LQW18ANR22J80D	220	J: $\pm 5\%$	25	2.08	1330	280
	LQW18ANR25G80D	250	G: $\pm 2\%$	24	2.28	1330	250
	LQW18ANR25J80D	250	J: $\pm 5\%$	24	2.28	1330	250
	LQW18ANR27G80D	270	G: $\pm 2\%$	24	2.42	1250	260
	LQW18ANR27J80D	270	J: $\pm 5\%$	24	2.42	1250	260
	LQW18ANR30G80D	300	G: $\pm 2\%$	25	3.12	1200	220
	LQW18ANR30J80D	300	J: $\pm 5\%$	25	3.12	1200	220
	LQW18ANR33G80D	330	G: $\pm 2\%$	25	3.84	1100	190
	LQW18ANR33J80D	330	J: $\pm 5\%$	25	3.84	1100	190
	LQW18ANR36G80D	360	G: $\pm 2\%$	25	3.98	1050	190
	LQW18ANR36J80D	360	J: $\pm 5\%$	25	3.98	1050	190

Customer Part number	Murata Part number	Inductance		Q (Min.)	DC resistance (Ω max.)	Self-resonant frequency (MHz min.)	Rated current (mA) ^{*1}
		Nominal value (nH)	Tolerance				
	LQW18ANR39G80D	390	G: ±2%	25	4.23	1100	190
	LQW18ANR39J80D	390	J: ±5%	25	4.23	1100	190

*1 As shown in the diagram below, derating is applied to the rated current based on the operating temperature.

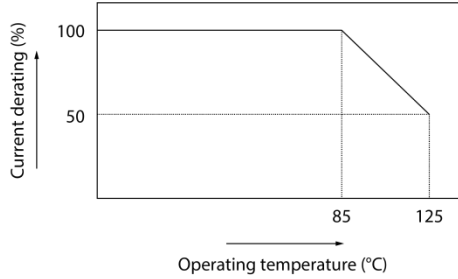

4. Testing Conditions

Unless otherwise specified	Temperature: ordinary temperature (15°C to 35°C) Humidity: ordinary humidity [25% to 85% (RH)]
In case of doubt	Temperature: 20°C±2°C Humidity: 60% to 70% (RH) Atmospheric pressure: 86 kPa to 106 kPa

5. Appearance and Dimensions

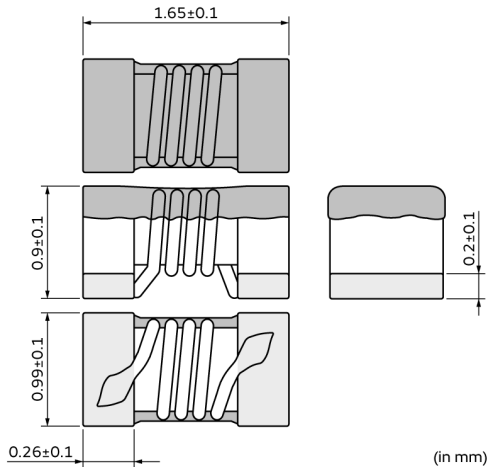

Unit mass (typical value): 0.0034 g

6. Marking

No marking.

7. Electrical Performance

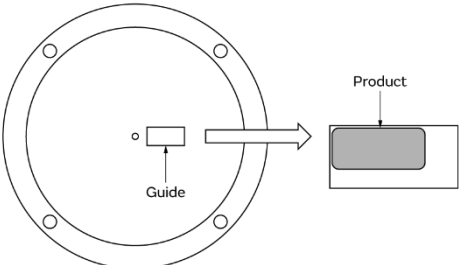
No.	Item	Specification	Test method												
7.1	Inductance	Meet chapter 3 ratings.	Measuring equipment: Keysight E4991A or the equivalent Measuring frequency: <table border="1" style="margin-left: 20px;"> <tr> <td>Inductance</td> <td colspan="2">100 MHz</td> </tr> <tr> <td rowspan="4">Q</td> <td>250 MHz</td> <td>2.2 nH to 44 nH</td> </tr> <tr> <td>200 MHz</td> <td>47 nH to 69 nH</td> </tr> <tr> <td>150 MHz</td> <td>72 nH to 150 nH</td> </tr> <tr> <td>100 MHz</td> <td>180 nH to 390 nH</td> </tr> </table> Measuring conditions: Measurement signal level: Approx. 0 dBm Measurement terminal distance: 1.0 mm Electrical length: 10.0 mm Measuring fixture: Keysight 16197A Position the chip coil under test as shown in the measuring example below and connect it to the electrode by applying weight.	Inductance	100 MHz		Q	250 MHz	2.2 nH to 44 nH	200 MHz	47 nH to 69 nH	150 MHz	72 nH to 150 nH	100 MHz	180 nH to 390 nH
Inductance	100 MHz														
Q	250 MHz	2.2 nH to 44 nH													
	200 MHz	47 nH to 69 nH													
	150 MHz	72 nH to 150 nH													
	100 MHz	180 nH to 390 nH													
7.2	Q	Meet chapter 3 ratings.	Measurement example: <div style="text-align: center; margin: 10px 0;">  <p>The diagram illustrates the measurement setup. On the left, a circular 'Guide' has four small circles representing contact points. An arrow points from the center of the guide to a rectangular 'Product' component on the right, which is shown sitting on a substrate.</p> </div> Measuring method: see "Electrical performance: Measuring method for inductance/Q" in the chapter "16. Appendix".												
7.3	DC resistance	Meet chapter 3 ratings.	Measuring equipment: digital multimeter												
7.4	Self-resonant frequency	Meet chapter 3 ratings.	Measuring equipment: Keysight N5230A or the equivalent												
7.5	Rated current	Product temperature rise: 40°C max.	Apply the rated current specified in chapter 3.												

8. Mechanical Performance

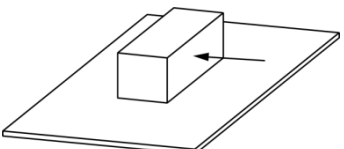
No.	Item	Specification	Test method
8.1	Shear test	No significant mechanical damage or no sign of electrode peeling off shall be observed.	Test substrate: glass-epoxy substrate Force application direction: <div style="text-align: center; margin: 10px 0;">  <p>The diagram shows a 3D perspective of a rectangular block resting on a flat rectangular substrate. An arrow points horizontally to the side of the block, indicating the direction of the shear force applied during the test.</p> </div> Applying force: 5 N Holding time: 5 s±1 s

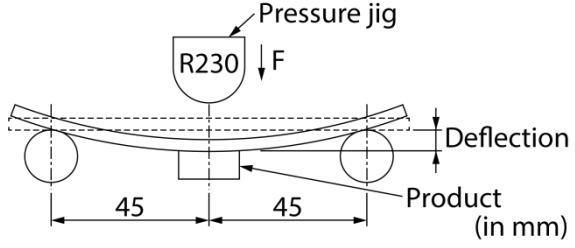
No.	Item	Specification	Test method
8.2	Bending test	No significant mechanical damage or no sign of electrode peeling off shall be observed.	<p>Test substrate: glass-epoxy substrate (100 mm × 40 mm × 1.6 mm) Pressurizing speed: 1 mm/s Deflection: 2 mm Holding time: 30 s</p> 
8.3	Vibration	Appearance shall have no significant mechanical damage.	<p>Oscillation frequency: 10 Hz to 55 Hz to 10 Hz, for approx. 1 min Total amplitude: 1.5 mm Test time: 3 directions perpendicular to each other, 2 h for each direction (6 h in total)</p>
8.4	Solderability	90% or more of the outer electrode shall be covered with new solder seamlessly.	<p>Flux: immersed in ethanol solution [including an activator with a chlorine conversion value of 0.06(wt)%] with a rosin content of 25(wt)% for 5 s to 10 s. Solder: Sn-3.0Ag-0.5Cu solder Pre-heating: 150°C±10°C/60 s to 90 s Solder temperature: 240°C±5°C Immersion time: 3 s±1 s</p>
8.5	Resistance to soldering heat	Appearance: No significant mechanical damage shall be observed. Inductance change rate: within ±5%	<p>Flux: immersed in ethanol solution [including an activator with a chlorine conversion value of 0.06(wt)%] with a rosin content of 25(wt)% for 5 s to 10 s. Solder: Sn-3.0Ag-0.5Cu solder Pre-heating: 150°C±10°C/60 s to 90 s Solder temperature: 270°C±5°C Immersion time: 10 s±1 s Post-treatment: left at a room condition for 24 h±2 h</p>

9. Environmental Performance

The product is soldered on a substrate for test.

No.	Item	Specification	Test method
9.1	Heat resistance	Appearance: No significant mechanical damage shall be observed. Inductance change rate: within ±5% Q change rate: within ±20%	<p>Temperature: 125°C±2°C Test time: 1000 h (+48 h, -0 h) Post-treatment: left at a room condition for 24 h±2 h</p>
9.2	Cold resistance	Appearance: No significant mechanical damage shall be observed. Inductance change rate: within ±5% Q change rate: within ±20%	<p>Temperature: -55°C±2°C Test time: 1000 h (+48 h, -0 h) Post-treatment: left at a room condition for 24 h±2 h</p>
9.3	Humidity	Appearance: No significant mechanical damage shall be observed. Inductance change rate: within ±5% Q change rate: within ±20%	<p>Temperature: 40°C±2°C Humidity: 90% (RH) to 95% (RH) Test time: 1000 h (+48 h, -0 h) Post-treatment: left at a room condition for 24 h±2 h</p>
9.4	Temperature cycle	Appearance: No significant mechanical damage shall be observed. Inductance change rate: within ±5% Q change rate: within ±20%	<p>Single cycle conditions: Step 1: -55°C±2°C/30 min±3 min Step 2: ordinary temperature/10 min to 15 min Step 3: +125°C±2°C/30 min±3 min Step 4: ordinary temperature/10 min to 15 min Number of testing: 10 cycles Post-treatment: left at a room condition for 24 h±2 h</p>

10. Specification of Packaging

10.1 Appearance and dimensions of tape (8 mm width/paper tape)

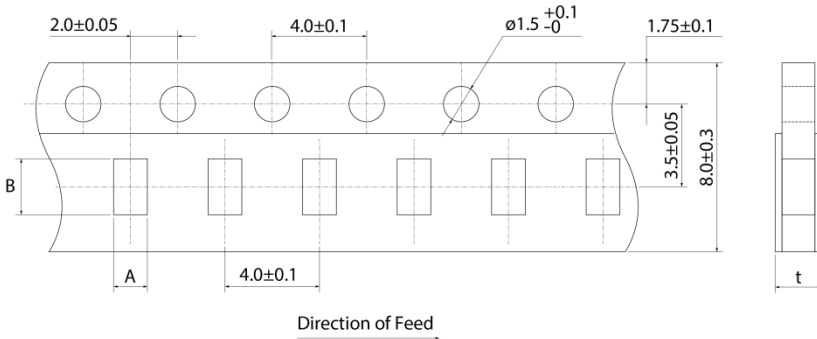

A	1.15±0.05
B	1.9±0.05
t	1.1 max.

(in mm)

10.2 Taping specifications

Packing quantity (Standard quantity)	4000 pcs/reel
Packing method	The products are placed in embossed cavities of a base tape and sealed by a top tape and a bottom tape.
Feed hole position	The feed holes on the base tape are on the right side when the top tape is pulled toward the user.
Joint	The base tape and the top tape are seamless.
Number of missing products	Number of missing products within 0.025% of the number per reel or 1 pc., whichever is greater, and are not continuous. The specified quantity per reel is kept.

10.3 Break down force of tape

Break down force of top tape	5 N min.
Break down force of bottom tape	5 N min.

10.4 Peeling off force of top tape

Speed of peeling off	300 mm/min
Peeling off force	0.1 N to 0.6 N (The lower limit is for typical value.)

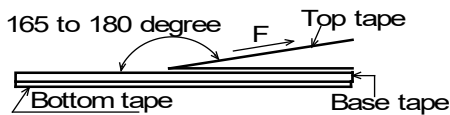

10.5 Dimensions of leader section, trailer section and reel

A vacant section is provided in the leader (start) section and trailer (end) section of the tape for the product. The leader section is further provided with an area consisting only of the cover tape (or top tape). (See the diagram below.)

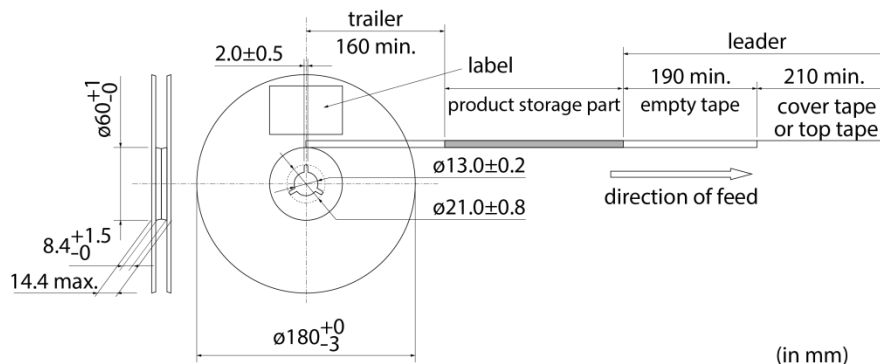

(in mm)

10.6 Marking for reel

Customer part number, Murata part number, inspection number (*1), RoHS marking (*2), quantity, etc.

*1 Expression of inspection No.: □□ ○○○○ ◇◇◇◇ — — — (1) (2) (3)	(1) Factory code (2) Date First digit: year/last digit of year Second digit: month/Jan. to Sep.→1 to 9, Oct. to Dec.→O, N, D Third, Fourth digit: day (3) Serial No.
*2 Expression of RoHS marking: ROHS- Y (△) — — — (1) (2)	(1) RoHS regulation conformity (2) Murata classification number

10.7 Marking on outer box (corrugated box)

Customer name, purchasing order number, customer part number, Murata part number, RoHS marking (*2), quantity, etc.

10.8 Specification of outer box

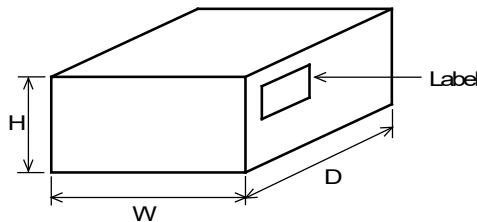

Dimensions of outer box (mm)			Standard reel quantity in outer box (reel)
W	D	H	
186	186	93	5
* Above outer box size is typical. It depends on a quantity of an order.			

11. ⚠ Caution

11.1 Limitation of applications

The products listed in the reference specification (hereinafter the product(s) is called as the "Product(s)") are designed and manufactured for applications specified in the reference specification (hereinafter called as the "Specific Application"). We shall not warrant anything in connection with the Products including fitness, performance, adequateness, safety, or quality, in the case of applications listed in from (1) to (11) written at the end of this precautions, which may generally require high performance, function, quality, management of production or safety. Therefore, the Product shall be applied in compliance with the specific application.

WE DISCLAIM ANY LOSS AND DAMAGES ARISING FROM OR IN CONNECTION WITH THE PRODUCTS INCLUDING BUT NOT LIMITED TO THE CASE SUCH LOSS AND DAMAGES CAUSED BY THE UNEXPECTED ACCIDENT, IN EVENT THAT (i) THE PRODUCT IS APPLIED FOR THE PURPOSE WHICH IS NOT SPECIFIED AS THE SPECIFIC APPLICATION FOR THE PRODUCT, AND/OR (ii) THE PRODUCT IS APPLIED FOR ANY FOLLOWING APPLICATION PURPOSES FROM (1) TO (11) (EXCEPT THAT SUCH APPLICATION PURPOSE IS UNAMBIGUOUSLY SPECIFIED AS SPECIFIC APPLICATION FOR THE PRODUCT IN OUR CATALOG SPECIFICATION FORMS, DATASHEETS, OR OTHER DOCUMENTS OFFICIALLY ISSUED BY US*).

- (1) Aircraft equipment
- (2) Aerospace equipment
- (3) Undersea equipment
- (4) Power plant control equipment
- (5) Medical equipment
- (6) Transportation equipment
- (7) Traffic control equipment
- (8) Disaster prevention/security equipment
- (9) Industrial data-processing equipment
- (10) Combustion/explosion control equipment
- (11) Equipment with complexity and/or required reliability equivalent to the applications listed in the above.

For exploring information of the Products which will be compatible with the particular purpose other than those specified in the reference specification, please contact our sales offices, distribution agents, or trading companies with which you make a deal, or via our web contact form.

Contact form: <https://www.murata.com/contactform>

* We may design and manufacture particular Products for applications listed in (1) to (11). Provided that, in such case we shall unambiguously specify such Specific Application in the reference specification without any exception. Therefore, any other documents and/or performances, whether exist or non-exist, shall not be deemed as the evidence to imply that we accept the applications listed in (1) to (11).

11.2 Precautions on rating

Avoid using in exceeded the rated temperature range, rated voltage, or rated current. Usage when the ratings are exceeded could lead to wire breakage, burning, or other serious fault.

11.3 Inrush current

If an inrush current (or pulse current or rush current) that significantly exceeds the rated current is applied to the product, overheating could occur, resulting in wire breakage, burning, or other serious fault.

11.4 Corrosive gas

Please refrain from use since contact with environments with corrosive gases (sulfur gas [hydrogen sulfide, sulfur dioxide, etc.], chlorine, ammonia, etc.) or oils (cutting oil, silicone oil, etc.) that have come into contact with the previously stated corrosive gas environment will result in deterioration of product quality or an open from deterioration due to corrosion of product electrode, etc. We will not bear any responsibility for use under these environments.

12. Precautions for Use

This product is for use only with reflow soldering. It is designed to be mounted by soldering. If you want to use other mounting method, for example, using a conductive adhesive, please consult us beforehand. Also, if repeatedly subjected to temperature cycles or other thermal stress, due to the difference in the coefficient of thermal expansion with the mounting substrate, the solder (solder fillet part) in the mounting part may crack. The occurrence of cracks due to thermal stress is affected by the size of the land where mounted, the solder volume, and the heat dissipation of the mounting substrate. Carefully design it when a large change in ambient temperature is assumed.

12.1 Land dimensions

The following diagram shows the recommended land dimensions for reflow soldering. The land dimensions are designed in consideration of electrical characteristics and mountability. Use of other land dimensions may preclude achievement of performance. In some cases, it may result in poor solderability, including positional shift. If you use other land pattern, consider it adequately.

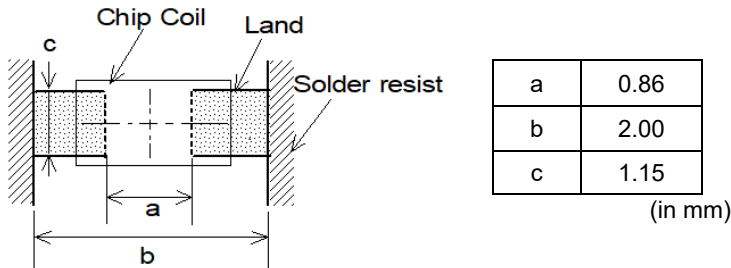

12.2 Flux and solder used

Flux	<ul style="list-style-type: none"> Use a rosin-based flux that includes an activator with a chlorine conversion value of 0.06 mass% to 0.1 mass%. Do not use a highly acidic flux with a halide content exceeding 0.2 mass% (chlorine conversion value). Do not use a water-soluble flux.
Solder	<ul style="list-style-type: none"> Use Sn-3.0Ag-0.5Cu solder. Standard thickness of solder paste: 100 μm to 150 μm

If you want to use a flux other than the above, please consult our technical department.

12.3 Soldering conditions (reflow)

- Pre-heating should be in such a way that the temperature difference between solder and product surface is limited to 150°C max.
Cooling into solvent after soldering also should be in such a way that the temperature difference is limited to 100°C max.
Insufficient pre-heating may cause cracks on the product, resulting in the deterioration of product quality.
- Standard soldering profile and the limit soldering profile is as follows.
The excessive limit soldering conditions may cause leaching of the electrode and/or resulting in the deterioration of product quality.

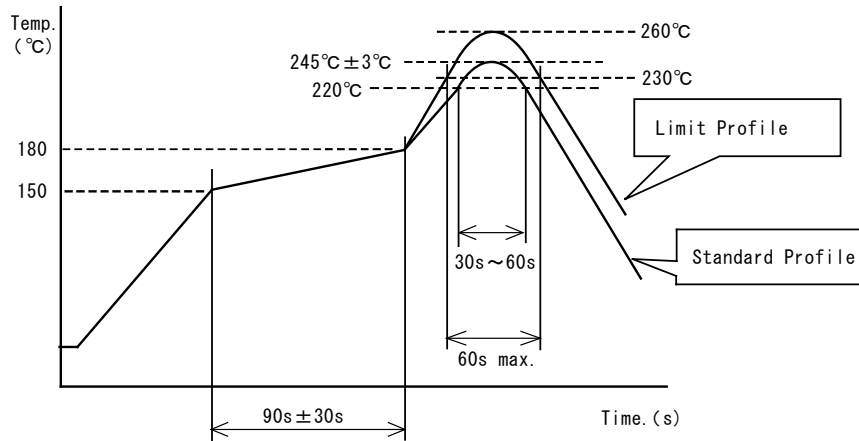

	Standard profile	Limit profile
Pre-heating	150°C to 180°C/90 s ± 30 s	150°C to 180°C/90 s ± 30 s
Heating	Above 220°C/30 s to 60 s	Above 230°C/60 s max.
Peak temperature	245°C ± 3°C	260°C/10 s
Number of reflow cycles	2 times	2 times

12.4 Reworking with soldering iron

The following requirements must be met to rework a soldered product using a soldering iron.

Item	Requirement
Pre-heating	150°C/approx. 1 min
Tip temperature of soldering iron	350°C max.
Power consumption of soldering iron	80 W max.
Tip diameter of soldering iron	ø3 mm max.
Soldering time	3 s (+1 s, -0 s)
Number of reworking operations	2 times max.
* Avoid a direct contact of the tip of the soldering iron with the product. Such a direction contact may cause cracks in the ceramic body due to thermal shock.	

12.5 Solder volume

Solder shall be used not to increase the volume too much.

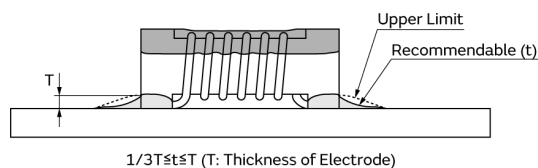

An increased solder volume increases mechanical stress on the product. Exceeding solder volume may cause the failure of mechanical or electrical performance.

12.6 Product's location

The following shall be considered when designing and laying out PCBs.

- (1) PCB shall be designed so that products are not subject to mechanical stress due to warping the board.
[Products direction]

Products shall be located in the sideways direction (length: $a < b$) to the mechanical stress.

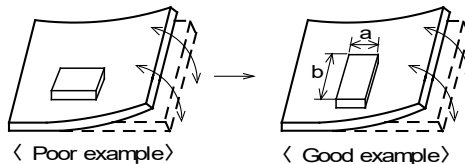

- (2) Components location on PCB separation

It is effective to implement the following measures, to reduce stress in separating the board.

It is best to implement all of the following three measures; however, implement as many measures as possible to reduce stress.

Contents of measures	Stress level
(1) Turn the mounting direction of the component parallel to the board separation surface.	$A > D^{*1}$
(2) Add slits in the board separation part.	$A > B$
(3) Keep the mounting position of the component away from the board separation surface.	$A > C$
*1 $A > D$ is valid when stress is added vertically to the perforation as with hand separation. If a cutting disc is used, stress will be diagonal to the PCB, therefore $A > D$ is invalid.	

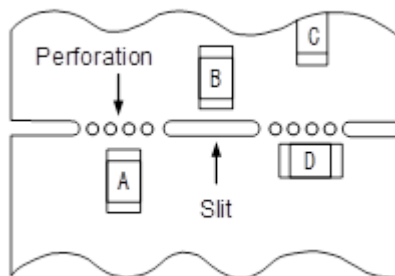

- (3) Mounting components near screw holes

When a component is mounted near a screw hole, it may be affected by the board deflection that occurs during the tightening of the screw.

Mount the component in a position as far away from the screw holes as possible.

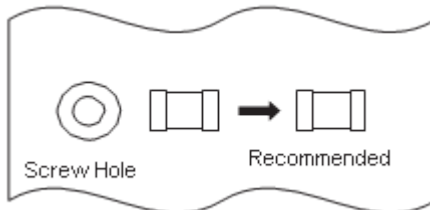

12.7 Handling of substrate

After mounting products on a substrate, do not apply any stress to the product caused by bending or twisting to the substrate when cropping the substrate, inserting and removing a connector from the substrate or tightening screw to the substrate. Excessive mechanical stress may cause cracking in the product.

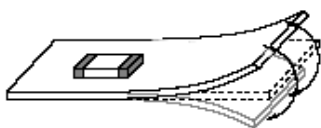

Bending

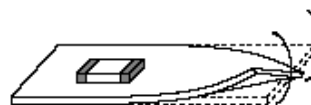

Twisting

12.8 Cleaning

The product shall be cleaned under the following conditions.

- (1) The cleaning temperature shall be 60°C max. If isopropyl alcohol (IPA) is used, the cleaning temperature shall be 40°C max.
- (2) Perform ultrasonic cleaning under the following conditions. Exercise caution to prevent resonance phenomenon in mounted products and the PCB.

Item	Requirement
Power	20 W/L max.
Time	5 min max.
Frequency	28 kHz to 40 kHz

- (3) Cleaner

Alcohol-based cleaner: IPA

Aqueous agent: PINE ALPHA ST-100S

- (4) There shall be no residual flux or residual cleaner. When using aqueous agent, rinse the product with deionized water adequately and completely dry it so that no cleaner is left.

* For other cleaning, consult our technical department.

12.9 Storage and transportation

Storage period	Use the product within 12 months after delivery. If you do not use the product for more than 12 months, check solderability before using it.
Storage conditions	<ul style="list-style-type: none"> • The products shall be stored in a room not subject to rapid changes in temperature and humidity. The recommended temperature range is -10°C to +40°C. The recommended relative humidity range is 15% to 85%. Keeping the product in corrosive gases, such as sulfur, chlorine gas or acid may cause the poor solderability. • Do not place the products directly on the floor; they should be placed on a palette so that they are not affected by humidity or dust. • Avoid keeping the products in a place exposed to direct sunlight, heat or vibration. • Do not keep products in bulk packaging. Bulk storage could result in collisions between the products or between the products and other parts, resulting in chipping or wire breakage. • Avoid storing the product by itself bare (i.e. exposed directly to air).
Transportation	Excessive vibration and impact reduces the reliability of the products. Exercise caution when handling the products.

12.10 Resin coating (including moisture-proof coating)

When the product is coated/molded with resin, its electrical characteristics may change.

A wire breakage issue may occur by mechanical stress caused by the resin, amount/cured shape of resin, or operating condition etc.

Some resins contain impurities or hydrolyzable chlorine, which could result in corrosion of the conducting materials, leading to wire breakage.

So, please pay your careful attention when you select resin in case of coating/molding the products with the resin.

Prior to use the coating resin, please make sure no reliability issue is observed by evaluating products mounted on your board.

12.11 Mounting conditions

Check the mounting condition before using.

Using mounting conditions (nozzles, equipment conditions, etc.) that are not suitable for products may lead to pick up errors, misalignment, or damage to the product.

With some types of mounting equipment, a support pin pushes up the product from the bottom of the base (paper) tape when the product is sucked with the pick-up nozzle. When using this type of equipment, detach the support pin to prevent the breaking of wire on the product.

In some cases, the laser recognition function of the mounting equipment may not recognize this product correctly.

Please contact us when using laser recognition. (There is no problem with the permeation and reflection type.)

12.12 Operating environment

Do not use this product under the following environmental conditions as it may cause deterioration of product quality.

- (1) In the corrodible atmosphere such as acidic gases, alkaline gases, chlorine, sulfur gases, organic gases and etc.
(the sea breeze, Cl₂, H₂S, NH₃, SO₂, NO₂, etc)
- (2) In the atmosphere where liquid such as organic solvent, may splash on the products.
- (3) In the atmosphere where the temperature/humidity changes rapidly and it is easy to dew.

12.13 Mounting density

If this product is placed near heat-generating products, be sure to implement sufficient heat-dissipating measures. If this product is subjected to a significant amount of heat from other products, this could adversely affect product quality, resulting in a circuit malfunction or failure of the mounted section. Also, be sure that the product is used in a manner so that the heat that the product is subjected to from other products does not exceed the upper limit of the rated operating temperature for the product.

12.14 Handling of product

- To prevent wire breakage, sharp objects such as tweezers, bristles of cleaning brushes, and other objects must not contact the winding section or the electrode section.
- Mechanical shock should not be applied to the products mounted on the board to prevent the breaking of the core.

13.  Note

- (1) Please make sure that your product has been evaluated in view of your specifications with our product being mounted to your product.
- (2) You are requested not to use our product deviating from the reference specifications.
- (3) The contents of this reference specification are subject to change without advance notice. Please approve our product specifications or transact the approval sheet for product specifications before ordering.

14. Appendix

Electrical performance: Measuring method for inductance/Q (Q measurement is applicable only when the Q value is included in the rating table.)

Perform measurement using the method described below. (Perform correction for the error deriving from the measuring terminal.)

(1) Residual elements and stray elements of the measuring terminal can be expressed by the F parameter for the 2-pole terminal as shown in the figure below.

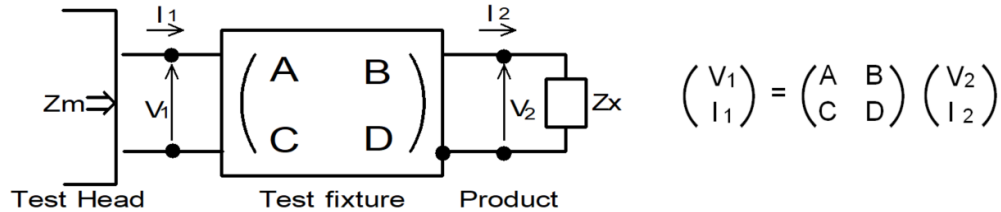

(2) The product's impedance value (Z_x) and measured impedance value (Z_m) can be expressed as shown below, by using the respective current and voltage for input/output.

$$Z_m = \frac{V_1}{I_1} \quad Z_x = \frac{V_2}{I_2}$$

(3) Thus, the relationship between the product's impedance value (Z_x) and measured impedance value (Z_m) is as follows.

$Z_x = \alpha \frac{Z_m - \beta}{1 - Z_m \Gamma}$	<p>Here,</p> <p>$\alpha = D/A = 1$</p> <p>$\beta = B/D = Z_{sm} - (1 - Y_{om} Z_{sm}) Z_{ss}$</p> <p>$\Gamma = C/A = Y_{om}$</p> <p>$Z_{sm}$: measured impedance of short chip</p> <p>Z_{ss}: residual impedance of short chip (0.771 nH)</p> <p>Y_{om}: measured admittance when measuring terminal is open</p>
---	--

(4) Calculate inductance L_x and Q_x using the equations shown below.

$L_x = \frac{\text{Im}(Z_x)}{2\pi f}$	<p>L_x: inductance of chip coil</p> <p>Q_x: Q of chip coil</p> <p>f: measuring frequency</p>
$Q_x = \frac{\text{Im}(Z_x)}{\text{Re}(Z_x)}$	

OUR CERTIFICATE

DiGi provide top-quality products and perfect service for customer worldwide through standardization, technological innovation and continuous improvement. DiGi through third-party certification, we stricly control the quality of products and services. Welcome your RFQ to

Email: Info@DiGi-Electronics.com



Tel: +00 852-30501935

RFQ Email: Info@DiGi-Electronics.com

DiGi is a global authorized distributor of electronic components.