

OVM4RTXV Datasheet



DiGi Electronics Part Number	OVM4RTXV-DG
Manufacturer	TT Electronics/Optek Technology
Manufacturer Product Number	OVM4RTXV
Description	LED RED CLEAR TO46 T/H
Detailed Description	Red 624nm LED Indication - Discrete 1.8V TO-46-2 Lens Top Metal Can

<https://www.DiGi-Electronics.com>

This model OVM4RTXV is available at DiGi Electronics.

DiGi Electronics offers a global database of semiconductor and electronic component datasheets.

We welcome your inquiries regarding pricing, lead time, or other product-related questions.

 [Request a Quote](#)

 [Datasheet Search](#)



Tel: +00 852-30501935

RFQ Email: Info@DiGi-Electronics.com

DiGi is a global authorized distributor of electronic components.

Purchase and inquiry

Manufacturer Product Number:

OVM4RTXV

Series:

-

Color:

Red

Lens Color:

Colorless

Millicandela Rating:

3300mcd

Lens Size:

4.63mm Dia

Current - Test:

20mA

Mounting Type:

Through Hole

Wavelength - Peak:

630nm

Package / Case:

TO-46-2 Lens Top Metal Can

Size / Dimension:

-

Manufacturer:

TT Electronics/Optek Technology

Product Status:

Obsolete

Configuration:

Standard

Lens Transparency:

Clear

Lens Style:

Round with Domed Top

Voltage - Forward (Vf) (Typ):

1.8V

Viewing Angle:

18°

Wavelength - Dominant:

624nm

Features:

-

Supplier Device Package:

TO-46

Height (Max):

4.79mm

Environmental & Export classification

RoHS Status:

ROHS3 Compliant

REACH Status:

REACH Unaffected

HTSUS:

8541.41.0000

Moisture Sensitivity Level (MSL):

1 (Unlimited)

ECCN:

EAR99

Hi-Reliability Visible LED Lamp (TO46)



OVM4x, OVM4xTX, OVM4xTXV

- Hermetically sealed TO-46 package
- Choice of blue, green, red or yellow
- High-brightness with well-defined spatial radiation patterns
- ESD protection built in

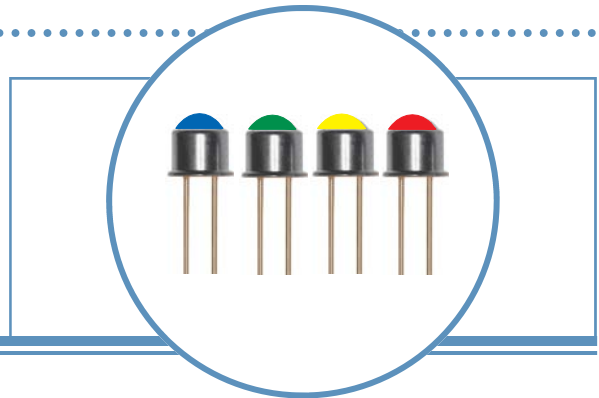

Each **OVM4x**, **OVM4xTX** and **OVM4xTXV** device is a high-reliability, high-sensitivity visible LED that is mounted in a hermetically sealed TO-46 package.

“Hi-Reliability” Visible LEDs function in the abnormally severe levels of mechanical, environmental and electrical stress that are typical of military and harsh industrial applications.

OVM4xTX and **OVM4xTXV** devices are processed to OPTEK’s 100% screening and QCI program-patterned after MIL-PRF-19500. Group A and B are performed on every lot. Group C is performed every six months.

Applications

- Automotive exterior and interior lighting
- Architectural lighting
- Electronic signs and signals

Part Number	Part Number	Material	Emitted Color	Intensity Typ. (mcd)	Lens Color
OVM4BTX	OVM4BTXV	InGaN	Blue	2260	Clear Glass
OVM4GTX	OVM4GTXV	InGaN	Green	6520	Clear Glass
OVM4RTX	OVM4RTXV	AllnGaP	Red	3300	Clear Glass
OVM4YTX	OVM4YTXV	AllnGaP	Yellow	2010	Clear Glass

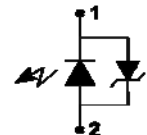
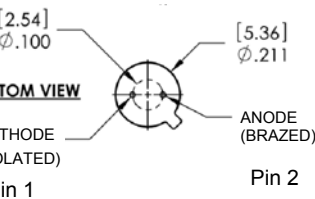
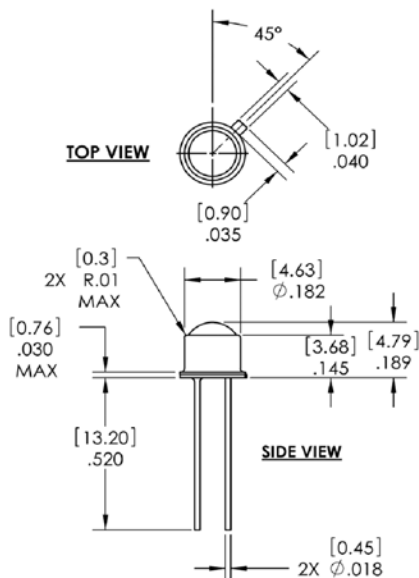

DO NOT LOOK DIRECTLY AT LED WITH UNSHIELDED EYES OR DAMAGE TO RETINA MAY OCCUR.

Dimensions are in inches [mm]



OPTEK reserves the right to make changes at any time in order to improve design and to supply the best product possible.

Hi-Reliability Visible LED Lamp

OVM4x, OVM4xTX, OVM4xTXV



Absolute Maximum Ratings

$T_A = 25^\circ\text{C}$ unless otherwise noted

Storage Temperature Range	-65° C to +150° C
Operating Temperature Range	-55° C to +100° C
Reverse Voltage	5 V
Continuous Forward Current ²	100 mA
Peak Forward Current (10% Duty Cycle, 1 KHz)	1.6 A
Power Dissipation	370 mW
Lead Soldering Temperature (3mm from the case) ¹	260° C
Current Linearity vs. Ambient Temperature	-0.2 mA/° C
LED Junction Temperature	115° C

Notes:

- Solder time less than 5 seconds at temperature extreme.
- Design of heat dissipation should be considered.

Electrical Characteristics

$T_A = 25^\circ\text{C}$ unless otherwise noted

SYMBOL	PARAMETER		MIN	TYP	MAX	UNITS	CONDITIONS
I_v	Luminous Intensity	Blue	----	2260	----	mcd	$I_F = 20\text{ mA}$
		Green	----	6520	----		
		Red	----	3300	----		
		Yellow	----	2010	----		
V_F	Forward Voltage	Blue	----	2.60	2.95	V	$I_F = 20\text{ mA}$
		Green	----	2.60	2.95		
		Red	----	1.80	2.15		
		Yellow	----	1.80	2.15		
λ_P	Peak Wavelength	Blue	----	463	----	nm	$I_F = 20\text{ mA}$
		Green	----	530	----		
		Red	----	630	----		
		Yellow	----	591	----		
λ_D	Dominant Wavelength	Blue	460	465	470	nm	$I_F = 20\text{ mA}$
		Green	520	530	540		
		Red	619	624	629		
		Yellow	584	589	594		
$\Delta\lambda$	Spectral Half Width	Blue	----	22	----	nm	$I_F = 20\text{ mA}$
		Green	----	35	----		
		Red	----	15	----		
		Yellow	----	18	----		
$2\theta_{1/2}$	50% Power Angle		----	18	----	deg	$I_F = 20\text{ mA}$

Notes:

- All ranks will be included per delivery, rank ratio will be based on the chip distribution.
- To designate luminous intensity ranks, please contact OPTEK.
- Pb content <1000 PPM.

OPTEK reserves the right to make changes at any time in order to improve design and to supply the best product possible.

Hi-Reliability Visible LED Lamp

OVM4x, OVM4xTX, OVM4xTXV



Typical Electro-Optical Characteristics Curves

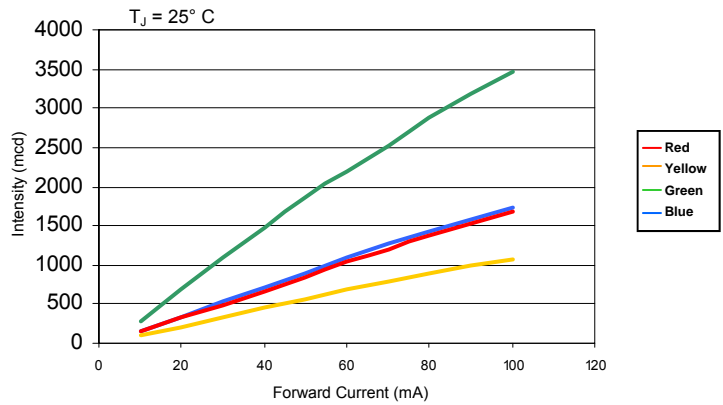
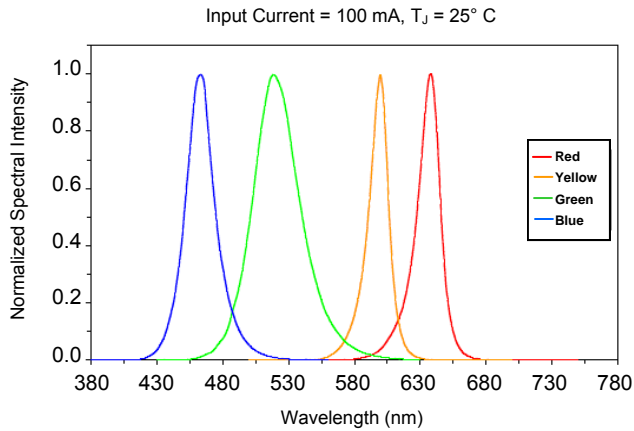

Intensity vs Forward Current

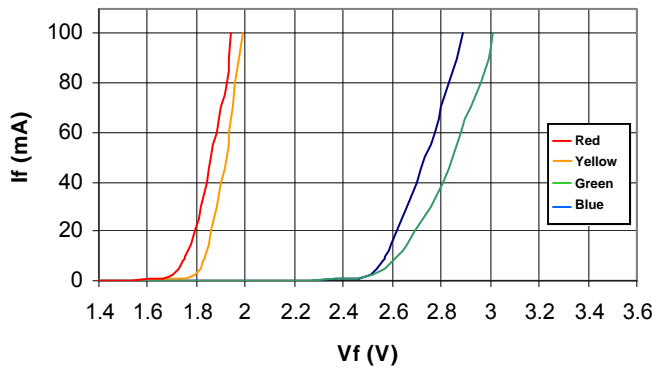

Forward Voltage vs Forward Current

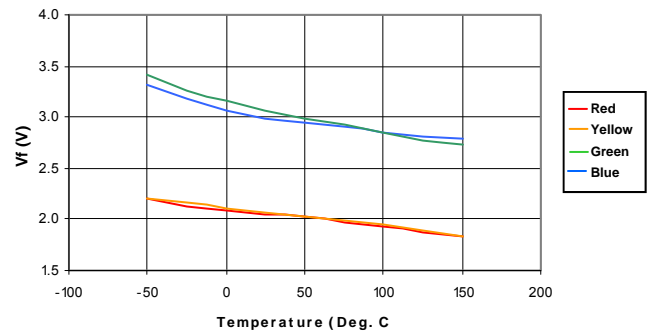

Forward Voltage vs Temperature

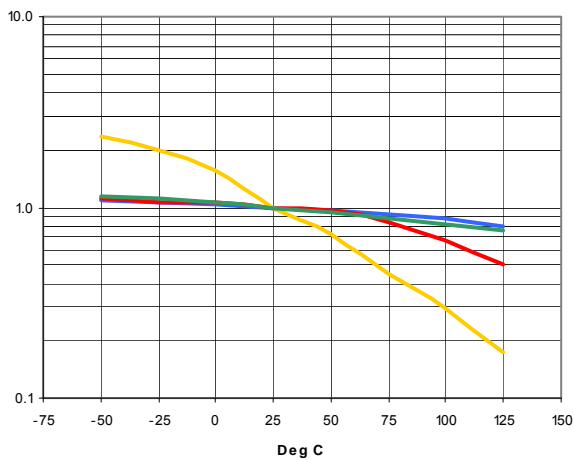

Relative Intensity vs Temperature

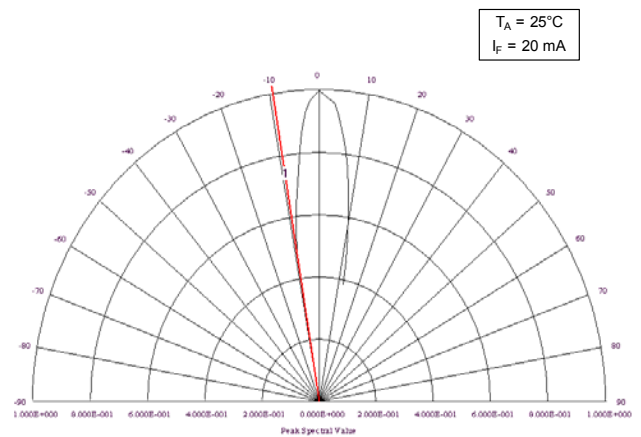

Spatial Intensity Distribution

OPTEK reserves the right to make changes at any time in order to improve design and to supply the best product possible.

Hi-Reliability Visible LED Lamp

OVM4x, OVM4xTX, OVM4xTXV



Shipping Information:

Optek UV LEDs are shipped in either of the below noted conductive trays made for ESD sensitive devices. Each tray contains up to 100 pieces and is then sealed in a plastic ESD bag. Tray dimensions are in inches (mm).

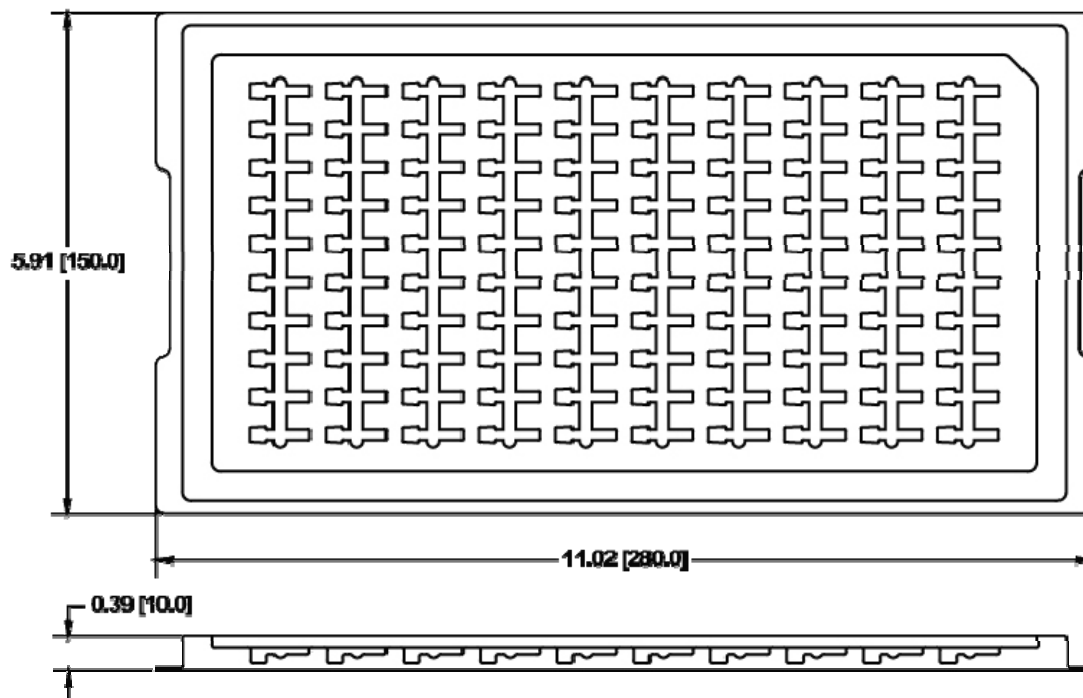
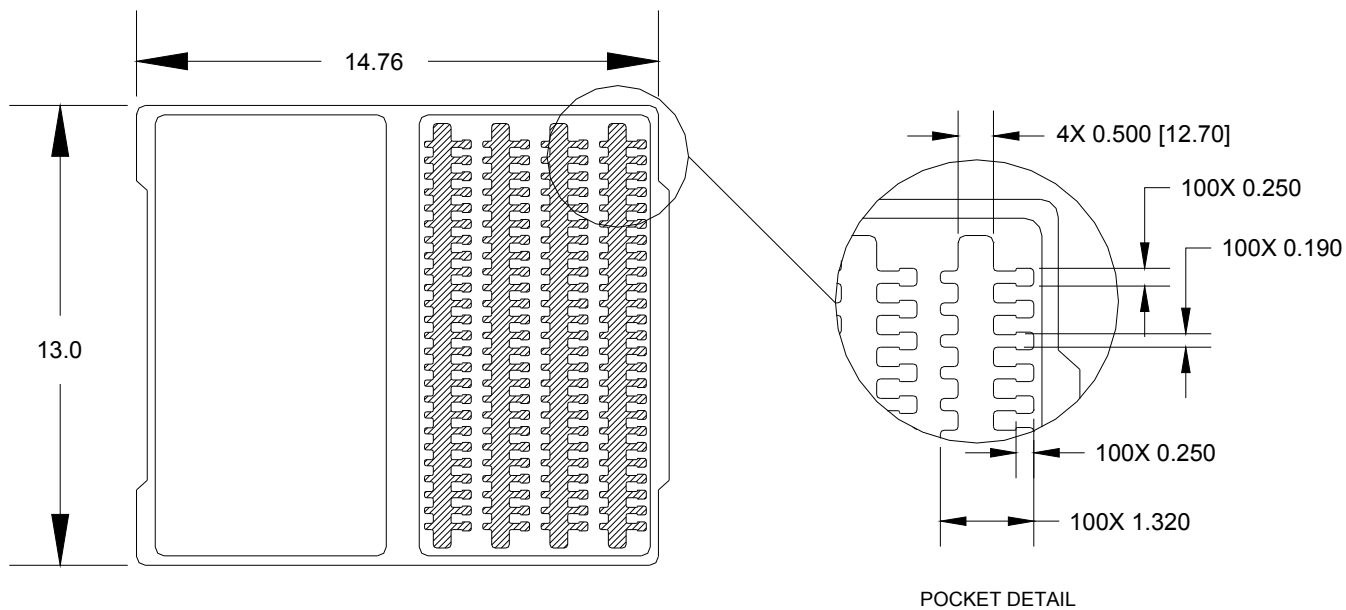

OPTEK reserves the right to make changes at any time in order to improve design and to supply the best product possible.

OUR CERTIFICATE

DiGi provide top-quality products and perfect service for customer worldwide through standardization, technological innovation and continuous improvement. DiGi through third-party certification, we stricly control the quality of products and services. Welcome your RFQ to

Email: Info@DiGi-Electronics.com



Tel: +00 852-30501935

RFQ Email: Info@DiGi-Electronics.com

DiGi is a global authorized distributor of electronic components.