

# UM3491EESE Datasheet

[www.digi-electronics.com](http://www.digi-electronics.com)

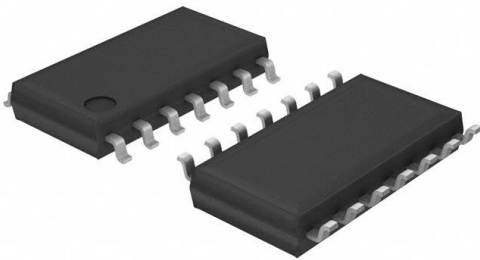

<https://www.DiGi-Electronics.com>

DiGi Electronics Part Number	UM3491EESE-DG
Manufacturer	<a href="#">Union Semiconductor International Limited</a>
Manufacturer Product Number	UM3491EESE
Description	IC TRANSCEIVER FULL 1/1 14SOP
Detailed Description	1/1 Transceiver Full RS422 14-SOP



Tel: +00 852-30501935

RFQ Email: [Info@DiGi-Electronics.com](mailto:Info@DiGi-Electronics.com)

DiGi is a global authorized distributor of electronic components.



## Purchase and inquiry

Manufacturer Product Number:

UM3491EESE

Series:

-

Type:

Transceiver

Number of Drivers/Receivers:

1/1

Receiver Hysteresis:

100 mV

Voltage - Supply:

3.135V ~ 3.465V

Mounting Type:

Surface Mount

Supplier Device Package:

14-SOP

Manufacturer:

Union Semiconductor International Limited

Product Status:

Active

Protocol:

RS422

Duplex:

Full

Data Rate:

10Mbps

Operating Temperature:

-40°C ~ 85°C (TA)

Package / Case:

14-SOIC (0.154", 3.90mm Width)

## Environmental & Export classification

RoHS Status:

ROHS3 Compliant

REACH Status:

REACH Unaffected

HTSUS:

8542.39.0001

Moisture Sensitivity Level (MSL):

3 (168 Hours)

ECCN:

EAR99

**+3.3V Low Power, ±15kV ESD-Protected, Fail-Safe,  
RS-422 Transceivers**

**UM3488EESA SOP8**  
**UM3488EEPA DIP8**  
**UM3491EESE SOP14**  
**UM3491EEPE DIP14**

**General Description**

The UM3488/UM3491 is ±15kV electrostatic discharge (ESD)-protected, high-speed transceivers for RS-422 communication that contain one driver and one receiver. The UM3491 contains an additional receiver and driver enable control. The device features fail-safe circuitry, which guarantees a logic-high receiver output when the receiver inputs are open or shorted. This means that the receiver output will be a logic high if all transmitters on a terminated bus are disabled (high impedance). The UM3488/UM3491 allows transmit speeds up to 10Mbps. The device features enhanced ESD protection. All transmitter outputs and receiver inputs are protected to ±15kV using the Human Body Model.

These transceivers typically draw 180µA of supply current when unloaded, or when fully loaded with the drivers disabled.

The device has a 1/8-unit-load receiver input impedance that allows up to 256 transceivers on the bus. The UM3488/UM3491 is intended for full-duplex communications.

**Applications**

- RS-422 Communications
- Level Translators
- Transceivers for EMI-Sensitive Applications
- Industrial-Control Local Area Networks

**Features**

- ESD Protection for RS-422 I/O Pins ±15kV, Human Body Model
- True Fail-Safe Receiver while Maintaining EIA/TIA-422 Compatibility
- Maximum Data Rate up to 10Mbps
- Error-Free Data Transmission
- 1nA Low-Current Shutdown Mode (UM3491)
- Allow up to 256 Transceivers on the Bus

**Selector Guide**

Part Number	Half/Full Duplex	Data Rate (Mbps)	Slew-Rate Limited	Low-Power Shutdown	Receiver/Driver Enable	Quiescent Current (µA)	Transceivers On Bus	Pin Count
UM3488	full	10	Yes	No	No	180	256	8
UM3491	full	10	Yes	Yes	Yes	180	256	14

**Ordering Information**

Part Number	Temperature Range	Packaging Type	Shipping Qty
UM3488EESA	-40°C to +85°C	SOP8	3000pcs/13 Inch Tape & Reel
UM3488EEPA	-40°C to +85°C	DIP8	50pcs/Tube
UM3491EESE	-40°C to +85°C	SOP14	2500pcs/13 Inch Tape & Reel
UM3491EEPE	-40°C to +85°C	DIP14	25pcs/Tube

## Pin Configurations

## Top View

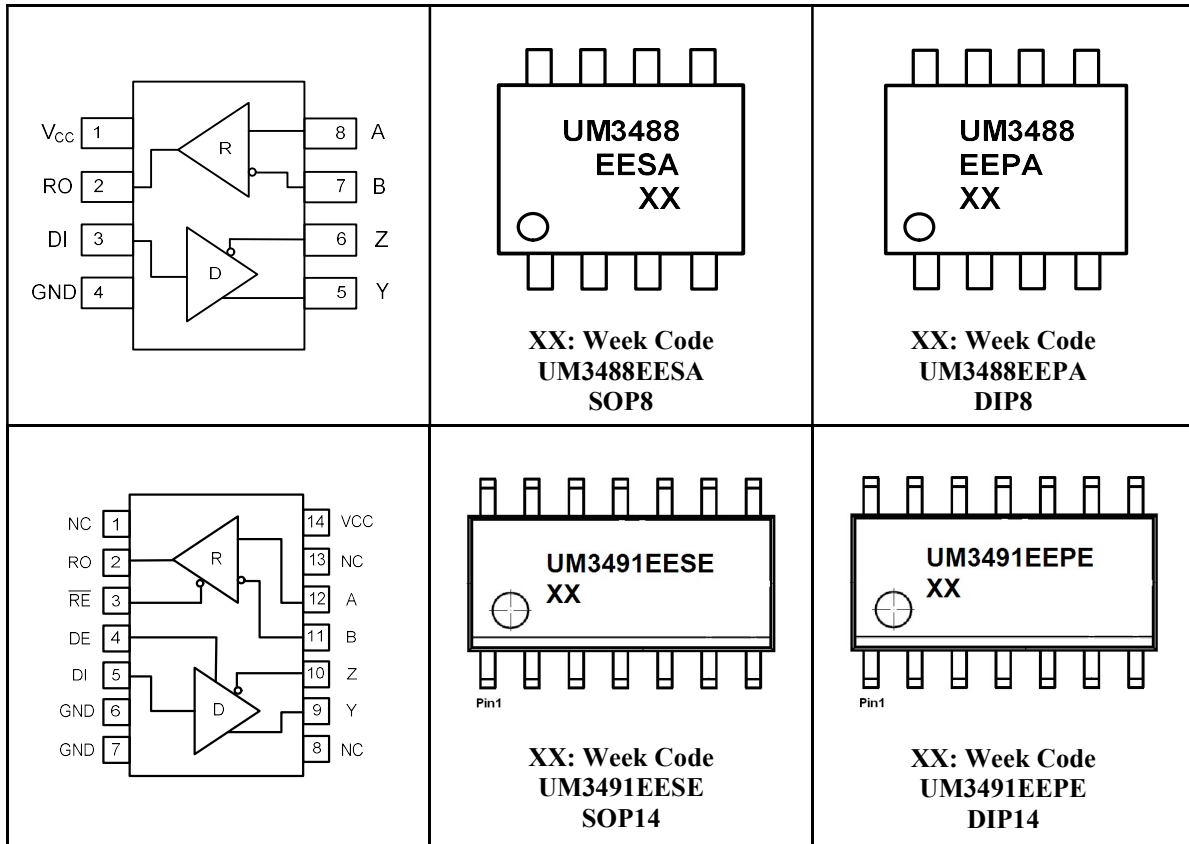

## Absolute Maximum Ratings

Symbol	Parameter	Value	Unit
V <sub>CC</sub>	Supply Voltage	+7	V
	Control Input Voltage (RE, DE)	-0.3V to (V <sub>CC</sub> + 0.3V)	V
	Driver Input Voltage (DI)	-0.3V to (V <sub>CC</sub> + 0.3V)	V
	Driver Output Voltage (Y, Z)	-7.5 to +12.5	V
	Receiver Input Voltage (A, B)	-7.5 to +12.5	V
	Receiver Output Voltage (RO)	-0.3V to (V <sub>CC</sub> + 0.3V)	V
P <sub>D</sub>	8-Pin SO (derate 9.09mW/°C above +70°C)	520	mW
	8-Pin Plastic DIP (derate 9.09mW/°C above +70°C)	727	
	14-Pin Plastic DIP (derate 10.0mW/°C above +70°C)	800	
	14-Pin SO (derate 8.33mW/°C above +70°C)	667	
T <sub>A</sub>	Ambient Temperature	-40 to +85	°C
T <sub>J</sub>	Junction Temperature	-40 to +150	°C
T <sub>STG</sub>	Storage Temperature Range	-65 to +150	°C
T <sub>L</sub>	Lead Temperature for Soldering 10 seconds	+300	°C

**Thermal Information**

Symbol	Thermal Metric	Value	UNIT
R <sub>θJA</sub>	Junction to Ambient Thermal Resistance	SOP8	110
		SOP14	85
		DIP8	87
		DIP14	63
R <sub>θJC</sub>	Junction to Case Thermal Resistance	SOP8	54
		SOP14	42
		DIP8	43
		DIP14	37

**DC Electrical Characteristics**

(V<sub>CC</sub> = +3.3V ± 5%, T<sub>A</sub> = T<sub>MIN</sub> to T<sub>MAX</sub>, unless otherwise noted. Typical values are at V<sub>CC</sub> = +3.3V and T<sub>A</sub> = +25°C.) (Note 1)

Parameter	Symbol	Test Conditions	Min	Typ	Max	Unit
<b>DRIVER</b>						
Differential Driver Output (No Load)	V <sub>OD1</sub>	Figure 3			V <sub>CC</sub>	V
Differential Driver Output	V <sub>OD2</sub>	Figure 3, R = 50Ω	1.8		V <sub>CC</sub>	V
Differential Driver Output	V <sub>OD3</sub>	Figure 3, R = 27Ω	1.3		V <sub>CC</sub>	V
Change-in-Magnitude of Differential Output Voltage (Note 2)	ΔV <sub>OD</sub>	Figure 3, R = 50Ω			0.2	V
Driver Common-Mode Output Voltage	V <sub>OC</sub>	Figure 3, R = 50Ω			3.0	V
Input High Voltage	V <sub>IH</sub>	DE, DI, $\overline{RE}$	2.0			V
Input Low Voltage	V <sub>IL</sub>	DE, DI, $\overline{RE}$			0.8	V
DI Input Hysteresis	V <sub>HYS</sub>			100		mV
Driver Short-Circuit Output Current (Note 3)	V <sub>OD1</sub>	-7V ≤ V <sub>OUT</sub> ≤ V <sub>CC</sub>	-250			mA
		0V ≤ V <sub>OUT</sub> ≤ 12V			250	
<b>RECEIVER</b>						
Input Current (A and B)	I <sub>IN</sub>	DE = GND, V <sub>CC</sub> = GND or 3.465V	V <sub>IN</sub> = 12V		125	μA
			V <sub>IN</sub> = -7V		-75	
Receiver Differential Threshold Voltage	V <sub>TH</sub>	-7V ≤ V <sub>CM</sub> ≤ 12V	-200	-125	-50	mV

Receiver Input Hysteresis	$\Delta V_{TH}$			25		mV	
Receiver Output High Voltage	$V_{OH}$	$I_O = -4mA, V_{ID} = -50mV$	$V_{CC} - 0.4$			V	
Receiver Output Low Voltage	$V_{OL}$	$I_O = 4mA, V_{ID} = -200mV$			0.4	V	
Three-State Output Current at Receiver	$I_{OZR}$	$0.4V \leq V_O \leq 2.4V$			$\pm 1$	$\mu A$	
Receiver Input Resistance	$R_{IN}$	$-7V \leq V_{CM} \leq 12V$	96			k $\Omega$	
Receiver Output Short Circuit Current	$I_{OSR}$	$0V \leq V_{RO} \leq V_{CC}$	$\pm 7$		$\pm 95$	mA	
<b>SUPPLY CURRENT</b>							
Supply Current	$I_{CC}$	No load, DE =DI=GND or $V_{CC}$	$\overline{RE} = V_{CC}$		20	60	$\mu A$
			$\overline{RE} = GND$		180	300	
Supply Current in Shutdown Mode	$I_{SHDN}$	DE = GND, $\overline{V_{RE}} = V_{CC}$			0.001	10	$\mu A$
ESD Protection for Y, Z, A, B		Human Body Model			$\pm 15$		kV

**Note 1:** All currents into the device are positive; all currents out of the device are negative. All voltages are referred to device ground unless otherwise noted.

**Note 2:**  $\Delta V_{OD}$  and  $\Delta V_{OC}$  are the changes in  $V_{OD}$  and  $V_{OC}$ , respectively, when the DI input changes state.

**Note 3:** Maximum current level applies to peak current just prior to foldback-current limiting; minimum current level applies during current limiting.

UM3488/UM3491 2019年12月10日 10:00:00 内部文件 仅供内部使用 未经许可 不得外传

**Switching Characteristics**

( $V_{CC} = +3.3V \pm 5\%$ ,  $T_A = T_{MIN}$  to  $T_{MAX}$ , unless otherwise noted. Typical values are at  $V_{CC} = +3.3V$  and  $T_A = +25^\circ C$ .)

Parameter	Symbol	Test Conditions	Min	Typ	Max	Unit
Driver Input-to-Output	$t_{DPLH}$	Figures 5 and 7, $R_{DIFF} = 54\Omega$ , $C_{L1} = C_{L2} = 100pF$	10	30	60	ns
	$t_{DPHL}$		10	30	60	
Driver Output Skew $ t_{DPLH} - t_{DPHL} $	$t_{DSKEW}$	Figures 5 and 7, $R_{DIFF} = 54\Omega$ , $C_{L1} = C_{L2} = 100pF$		10	25	ns
Driver Rise or Fall Time	$t_{DR}, t_{DF}$	Figures 5 and 7, $R_{DIFF} = 54\Omega$ , $C_{L1} = C_{L2} = 100pF$	5	15	30	ns
Maximum Data Rate	$f_{MAX}$				10	Mbps
Driver Enable to Output High	$t_{DZH}$	Figures 6 and 8, $C_L = 100pF$ , S2 closed		40	70	ns
Driver Enable to Output Low	$t_{DZL}$	Figures 6 and 8, $C_L = 100pF$ , S1 closed		40	70	ns
Driver Disable Time from Low	$t_{DLZ}$	Figures 6 and 8, $C_L = 15pF$ , S1 closed		40	70	ns
Driver Disable Time from High	$t_{DHZ}$	Figures 6 and 8, $C_L = 15pF$ , S2 closed		40	70	ns
Receiver Input to Output	$t_{RPLH}, t_{RPHL}$	Figures 9 and 11; $ V_{ID}  \geq 2.0V$ ; rise and fall time of $V_{ID} \leq 15ns$	20	100	180	ns
$ t_{RPLH} - t_{RPHL} $ Differential Receiver Skew	$t_{RSKD}$	Figures 9 and 11; $ V_{ID}  \geq 2.0V$ ; rise and fall time of $V_{ID} \leq 15ns$		13		ns
Receiver Enable to Output Low	$t_{RZL}$	Figures 4 and 10, $C_L = 100pF$ , S1 closed		40	100	ns
Receiver Enable to Output High	$t_{RZH}$	Figures 4 and 10, $C_L = 100pF$ , S2 closed		40	100	ns
Receiver Disable Time from Low	$t_{RLZ}$	Figures 4 and 10, $C_L = 100pF$ , S1 closed		40	100	ns
Receiver Disable Time from High	$t_{RHZ}$	Figures 4 and 10, $C_L = 100pF$ , S2 closed		40	100	ns
Time to Shutdown	$t_{SHDN}$	(Note 4)	50	200	600	ns
Driver Enable from Shutdown to Output High	$t_{DZH(SHDN)}$	Figures 6 and 8, $C_L = 15pF$ , S2 closed		40	200	ns
Driver Enable from Shutdown to Output Low	$t_{DZL(SHDN)}$	Figures 6 and 8, $C_L = 15pF$ , S1 closed		40	200	ns
Receiver Enable from Shutdown- to-Output High	$t_{RZH(SHDN)}$	Figures 4 and 10, $C_L = 100pF$ , S2 closed		150	500	ns
Receiver Enable from Shutdown- to-Output Low	$t_{RZL(SHDN)}$	Figures 4 and 10, $C_L = 100pF$ , S1 closed		150	500	ns

**Note 4:** The device is put into shutdown by bringing  $\overline{RE}$  high and DE low. If the enable inputs are in this state for less than 50ns, the device is guaranteed not to enter shutdown. If the enable inputs are in this state for at least 600ns, the device is guaranteed to have entered shutdown.



## Typical Operating Characteristics

( $V_{CC} = +3.3V$ ,  $T_A = +25^\circ C$ , unless otherwise noted.)

**No Load Supply Current vs. Temperature**

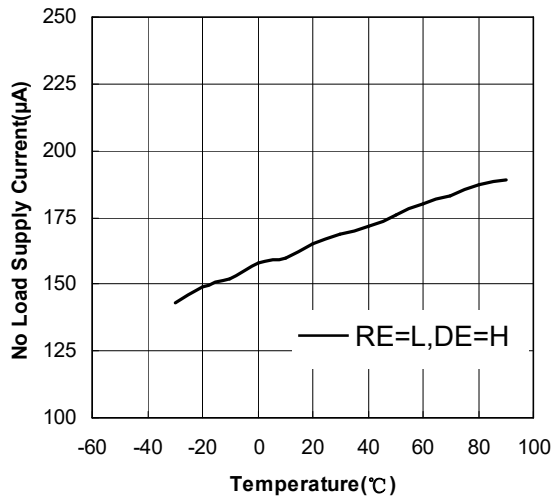

**Output Current vs. Receiver Output High Voltage**

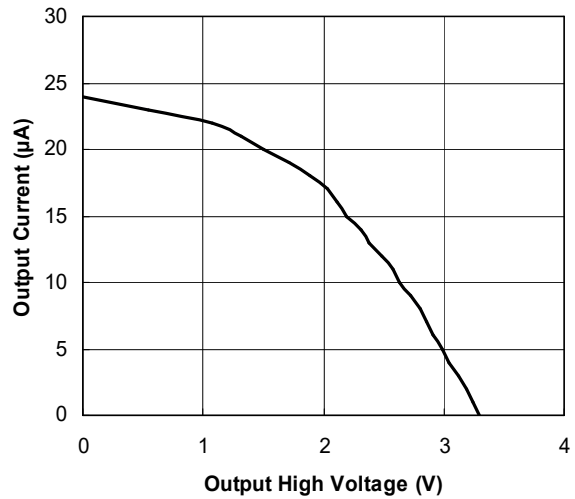

**Output Current vs. Receiver Output Low Voltage**

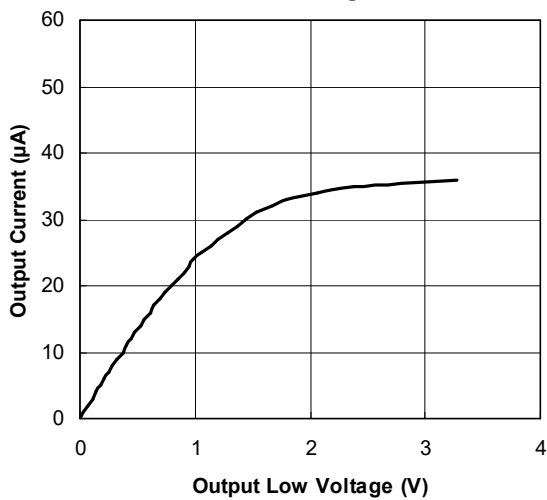

**Receiver Output High Voltage vs. Temperature**

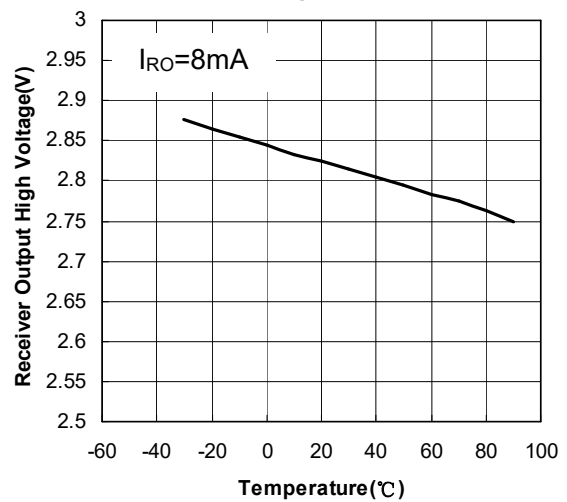

UM3491E2E2E UNION SEMICONDUCTOR International Limited IC TRANSCIEVER FULL T V 1 1 2019



**Typical Operating Characteristics (Continued)**  
 ( $V_{CC} = +3.3V$ ,  $T_A = +25^\circ C$ , unless otherwise noted.)

**Receiver Output Low Voltage vs. Temperature**

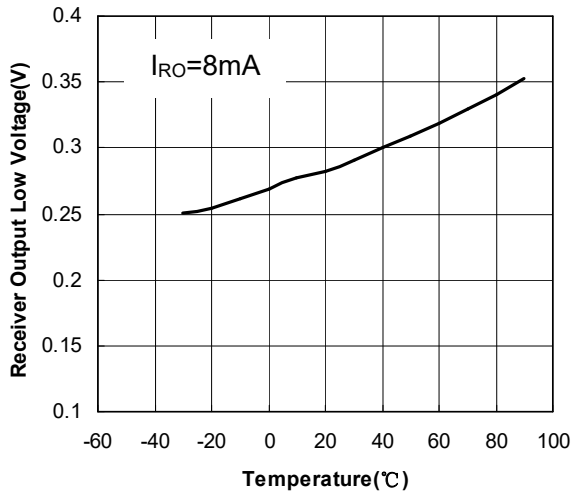

**Driver Differential Output Voltage vs. Temperature**

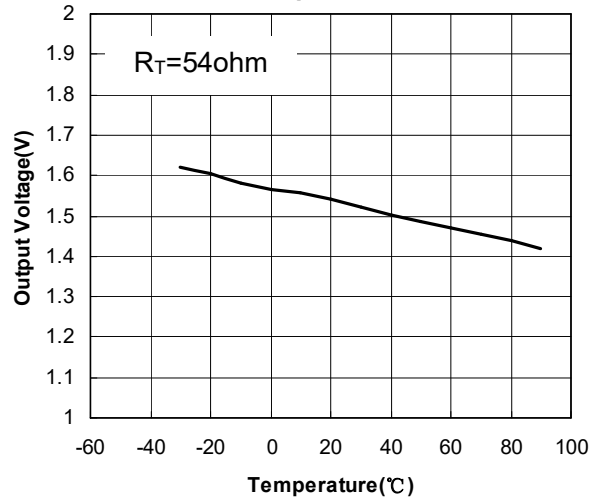

**Driver Output Current vs. Differential Output Voltage**

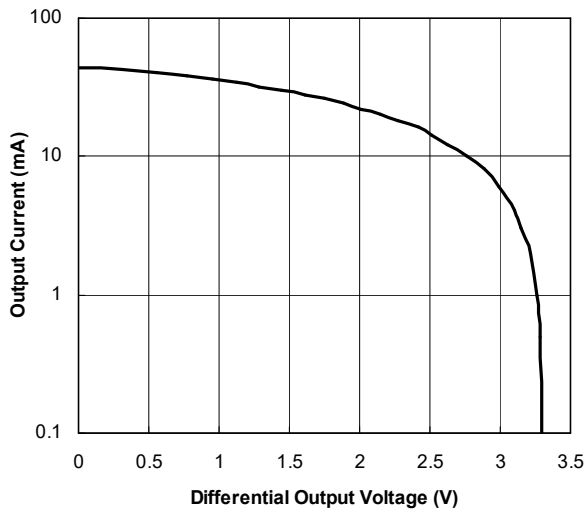

UM3488/UM3491 Union Semiconductor International Limited IC TRANSMITTERS AND RECEIVERS

**Pin Description**

Pin Number		Symbol	Function
UM3488	UM3491		
-	1	NC	Not Connected
2	2	RO	Receiver Output. When $\overline{RE}$ is low and if $A - B \geq -50\text{mV}$ , RO will be high; if $A - B \leq -200\text{mV}$ , RO will be low.
-	3	$\overline{RE}$	Receiver Output Enable. Drive $\overline{RE}$ low to enable RO; RO is high impedance when $\overline{RE}$ is high. Drive $\overline{RE}$ high and DE low to enter low-power shutdown mode.
-	4	DE	Driver Output Enable. Drive DE high to enable driver outputs. These outputs are high impedance when DE is low. Drive $\overline{RE}$ high and DE low to enter low-power shutdown mode.
3	5	DI	Driver Input. With DE high, a low on DI forces non-inverting output low and inverting output high. Similarly, a high on DI forces non-inverting output high and inverting output low.
4	6	GND	Ground
4	7	GND	Ground
-	8	NC	Not Connected
5	9	Y	Non-inverting Driver Output
6	10	Z	Inverting Driver Output
7	11	B	Inverting Receiver Input
8	12	A	Non-inverting Receiver Input
-	13	NC	Not Connected
1	14	VCC	Positive Supply $3.135\text{V} \leq VCC \leq 3.465\text{V}$

**Functions Tables**

TRANSMITTING				
INPUTS			OUTPUTS	
$\overline{RE}$	DE	DI	Z	Y
X	1	1	0	1
X	1	0	1	0
0	0	X	High-Z	High-Z
1	0	X	Shutdown	

RECEIVING			
INPUTS			OUTPUT
$\overline{RE}$	DE	A-B	RO
0	X	$\geq -0.05\text{V}$	1
0	X	$\leq -0.2\text{V}$	0
0	X	Open/Short	1
1	1	X	High-Z
1	0	X	Shutdown

Typical Operating Circuit

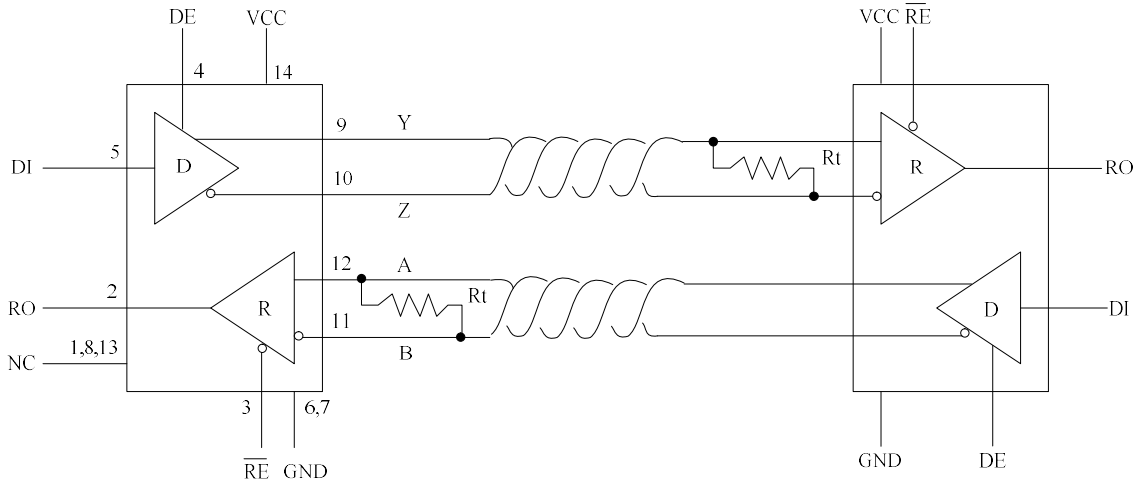

Figure 1: UM3491 pin configuration and typical full-duplex operating circuit

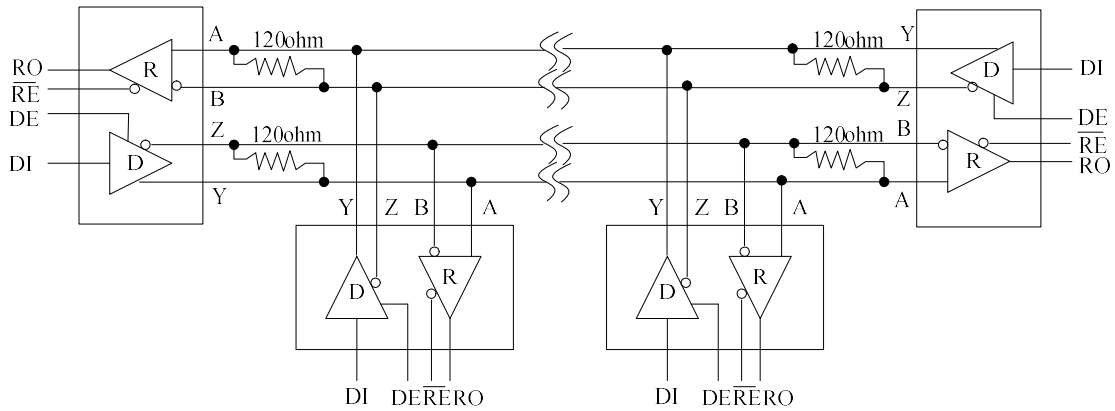

Figure 2: Typical Full-Duplex RS-422 Network

UM3491E2E2E UNION SEMICONDUCTOR LIMITED LIABILITY COMPANY

## Detailed Description

The UM3488/UM3491 high-speed transceivers for RS-422 communication contain one driver and one receiver. The device features fail-safe circuitry, which guarantees a logic-high receiver output when the receiver inputs are open or shorted, or when they are connected to a terminated transmission line with all drivers disabled.

The UM3488/UM3491 offer higher driver output slew-rate limits, allowing transmit speeds up to 10Mbps.

The UM3488/UM3491 is full-duplex transceiver. It operates from a single +3.3V supply. Drivers are output short-circuit current limited. Thermal shutdown circuitry protects drivers against excessive power dissipation. When activated, the thermal shutdown circuitry places the driver outputs into a high-impedance state.

## Receiver Input Filtering

The receivers of the UM3488/UM3491 incorporate input filtering in addition to input hysteresis. This filtering enhances noise immunity with differential signals that have very slow rise and fall times. Receiver propagation delay increases by 20% due to this filtering.

## Fail-Safe

The UM3488/UM3491 guarantees a logic-high receiver output when the receiver inputs are shorted or open, or when they are connected to a terminated transmission line with all drivers disabled. This is done by setting the receiver threshold between -50mV and -200mV. If the differential receiver input voltage (A-B) is greater than or equal to -50mV, RO is logic high. If A-B is less than or equal to -200mV, RO is logic low. In the case of a terminated bus with all transmitters disabled, the receiver's differential input voltage is pulled to 0V by the termination. With the receiver thresholds of the UM3488/UM3491, this results in a logic high with a 50mV minimum noise margin. Unlike previous fail-safe devices, the -50mV to -200mV threshold complies with the  $\pm 200\text{mV}$  EIA/TIA-422 standard.

## $\pm 15\text{kV}$ ESD Protection

As with all Union devices, ESD-protection structures are incorporated on all pins to protect against electrostatic discharges encountered during handling and assembly. The driver outputs and receiver inputs of the UM3488/UM3491 have extra protection against static electricity. Union's engineers have developed state-of-the-art structures to protect these pins against ESD of  $\pm 15\text{kV}$  without damage.

The ESD-protected pins are tested with reference to the ground pin in a powered-down condition. They are tested to  $\pm 15\text{kV}$  using the Human Body Model.

UM3488/UM3491 UNION SEMICONDUCTOR INFORMATION LITERATURE IC TRANSCEIVERS EN11 1 1 2017



**Test Circuit**

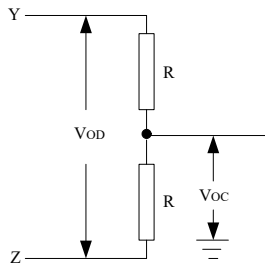

Figure 3. Driver DC Test Load

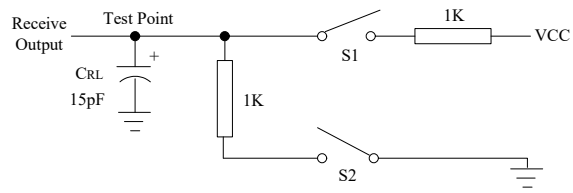

Figure 4. Receiver Enable/Disable Timing Test Load

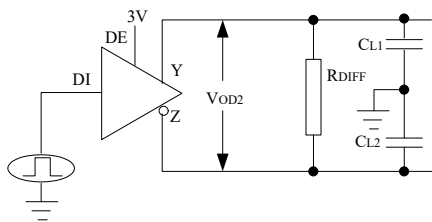

Figure 5. Driver Timing Test Circuit

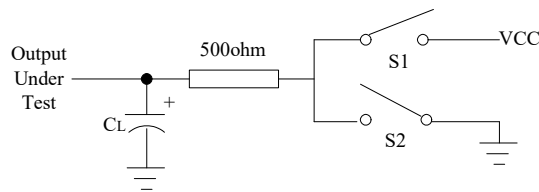

Figure 6. Driver Enable and Disable Timing Test Load

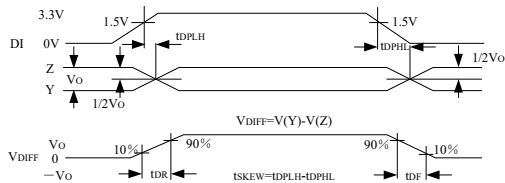

Figure 7. Driver Propagation Delays

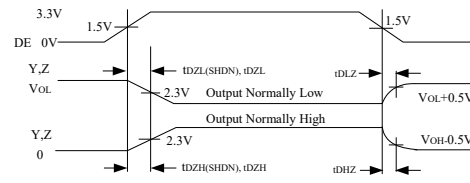

Figure 8. Driver Enable and Disable Times

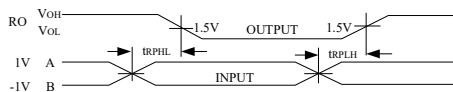

Figure 9. Receiver Propagation Delays

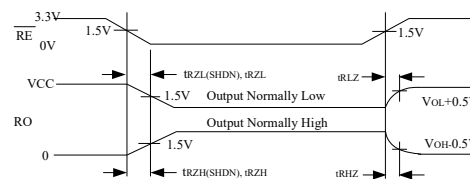

Figure 10. Receiver Enable and Disable Times

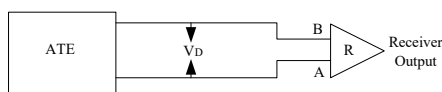

Figure 11. Receiver Propagation Delay Test Circuit

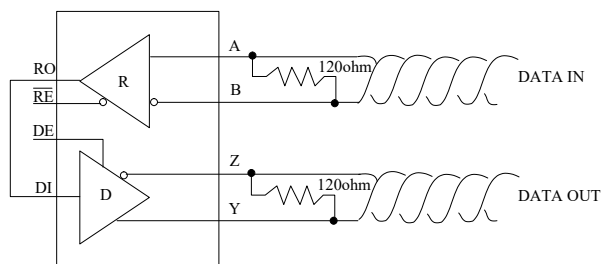

Figure 12: Line Repeater

## Applications Information

### 256 Transceivers on the Bus

The standard RS-422 receiver input impedance is 12k $\Omega$  (one-unit load), and the standard driver can drive up to 32 unit loads. The UM3491 has a 1/8-unit-load receiver input impedance (96k $\Omega$ ), allowing up to 256 transceivers to be connected in parallel on one communication line. Any combination of these devices and/or other RS-422 transceivers with a total of 32 unit loads or less can be connected to the line.

### Reduced EMI and Reflections

The UM3488/UM3491 is slew-rate limited, minimizing EMI and reducing reflections caused by improperly terminated cables. Its high-frequency harmonic components are much lower in amplitude, and the potential for EMI is significantly reduced.

In general, a transmitter's rise time relates directly to the length of an unterminated stub, which can be driven with only minor waveform reflections. The following equation expresses this relationship conservatively:

$$\text{Length} = t_{\text{RISE}} / (10 \times 1.5\text{ns/ft})$$

where  $t_{\text{RISE}}$  is the transmitter's rise time.

### Low-Power Shutdown Mode (UM3491)

Low-power shutdown mode is initiated by bringing both  $\overline{\text{RE}}$  high and DE low. In shutdown, the devices typically draw only 1nA of supply current.  $\overline{\text{RE}}$  and DE may be driven simultaneously; the parts are guaranteed not to enter shutdown if  $\overline{\text{RE}}$  is high and DE is low for less than 50ns. If the inputs are in this state for at least 600ns, the parts are guaranteed to enter shutdown.

Enable times  $t_{\text{ZH}}$  and  $t_{\text{ZL}}$  in the Switching Characteristics tables assume the part was not in a low-power shutdown state. Enable times  $t_{\text{ZH(SHDN)}}$  and  $t_{\text{ZL(SHDN)}}$  assume the parts were shut down. It takes drivers and receivers longer to become enabled from low-power shutdown mode ( $t_{\text{ZH(SHDN)}}$ ,  $t_{\text{ZL(SHDN)}}$ ) than from driver/receiver-disable mode ( $t_{\text{ZH}}$ ,  $t_{\text{ZL}}$ ).

### Driver Output Protection

Two mechanisms prevent excessive output current and power dissipation caused by faults or by bus contention. The first, a foldback current limit on the output stage, provides immediate protection against short circuits over the whole common-mode voltage range. The second, a thermal shutdown circuit, forces the driver outputs into a high-impedance state if the die temperature becomes excessive.

### Line Length vs. Data Rate

The RS-422 standard covers line lengths up to 4000 feet. For line lengths greater than 4000 feet, use the repeater application shown in Figure 12.

UM3488/UM3491 256 RS-422 Transceivers with 1/8-Unit Load

**Package Information**

**UM3488EESA SOP8**

**Outline Drawing**

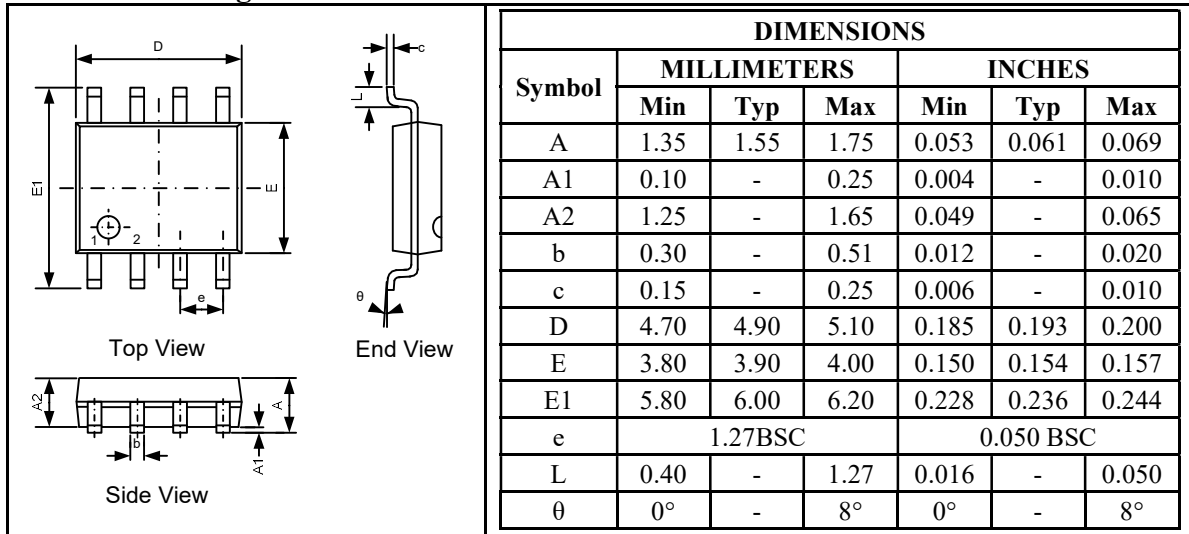

**Land Pattern**

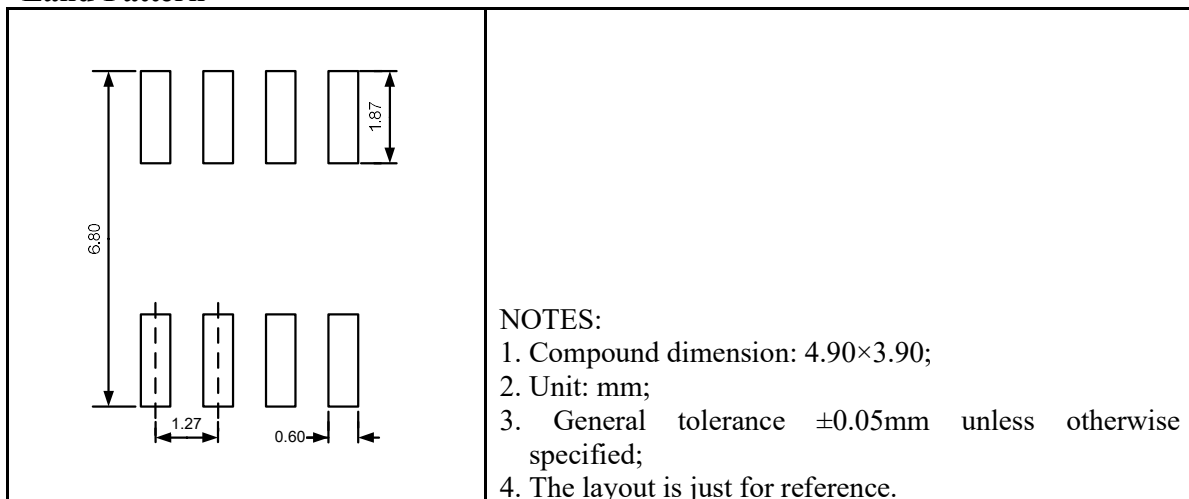

**Tape and Reel Orientation**

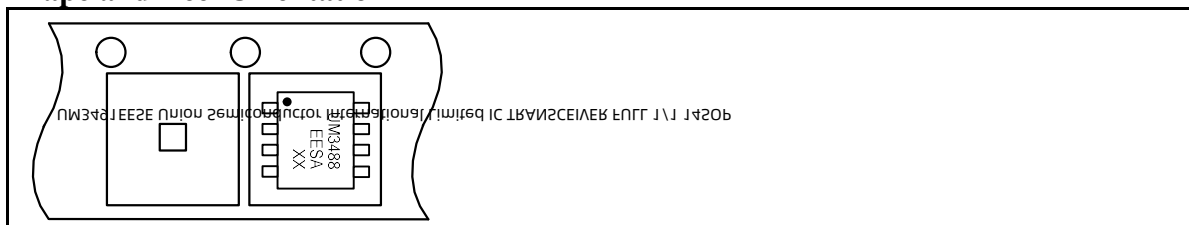

UM3488EPA DIP8

Outline Drawing

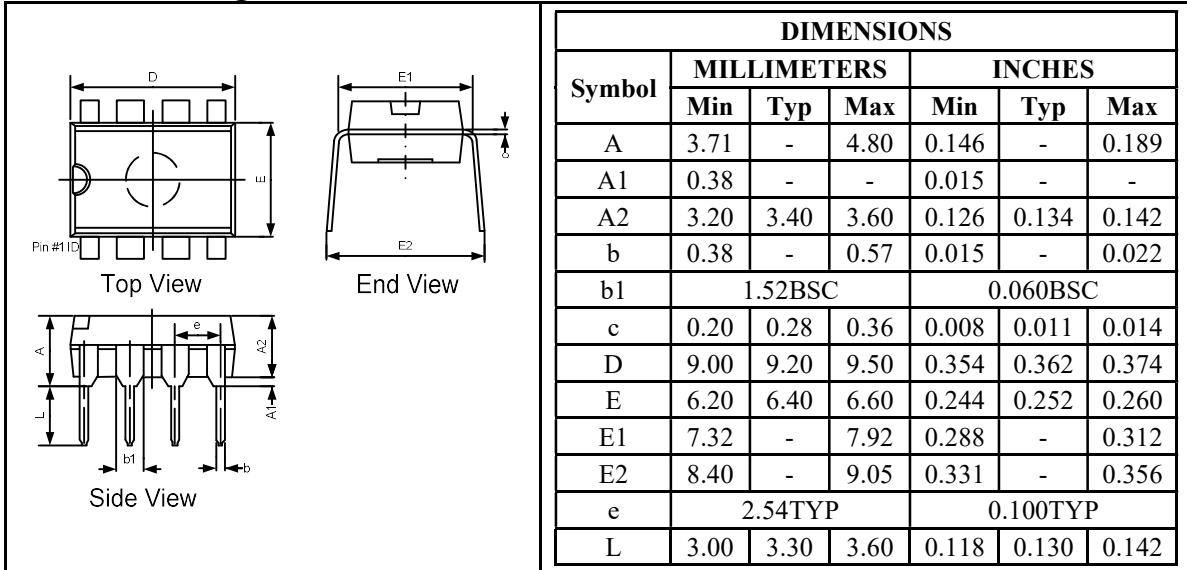

UM3491EE2E Union Semiconductor International Limited IC TRANSCEIVER FULL 1V 1420P



UM3491EESOP14

Outline Drawing

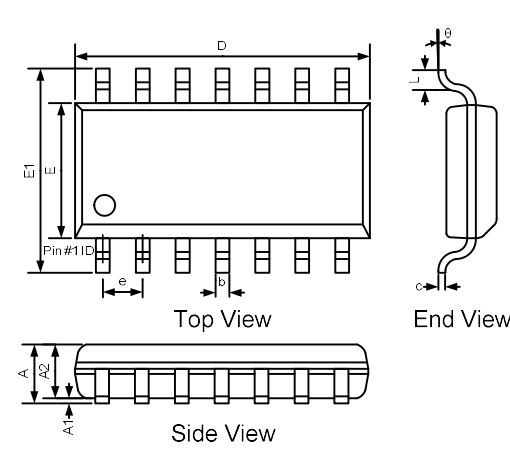

DIMENSIONS						
Symbol	MILLIMETERS			INCHES		
	Min	Typ	Max	Min	Typ	Max
A	1.35	1.60	1.75	0.053	0.063	0.069
A1	0.10	0.15	0.25	0.004	0.006	0.010
A2	1.25	1.45	1.65	0.049	0.057	0.065
b	0.36	-	0.49	0.014	-	0.019
c	0.17	-	0.25	0.007	-	0.010
D	8.53	8.63	8.73	0.336	0.340	0.344
E	3.80	3.90	4.00	0.150	0.154	0.157
E1	5.80	6.00	6.20	0.228	0.236	0.244
e	1.27BSC			0.050BSC		
L	0.45	0.60	0.80	0.018	0.024	0.031
θ	0°	-	8°	0°	-	8°

Land Pattern

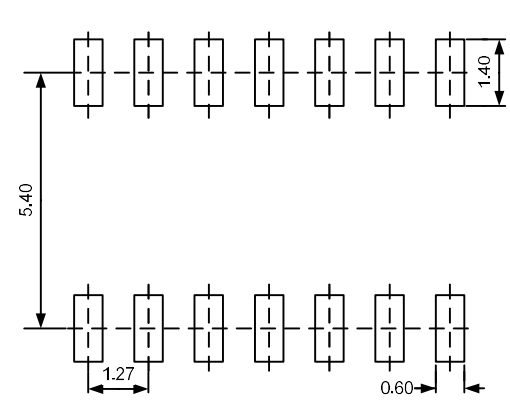

NOTES:

1. Compound dimension: 8.63×3.90 ;
2. Unit: mm;
3. General tolerance ±0.05mm unless otherwise specified;
4. The layout is just for reference.

Tape and Reel Orientation

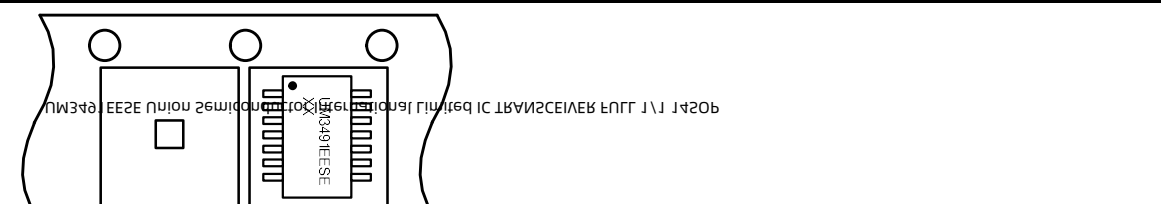

UM3491EEPE DIP14

Outline Drawing

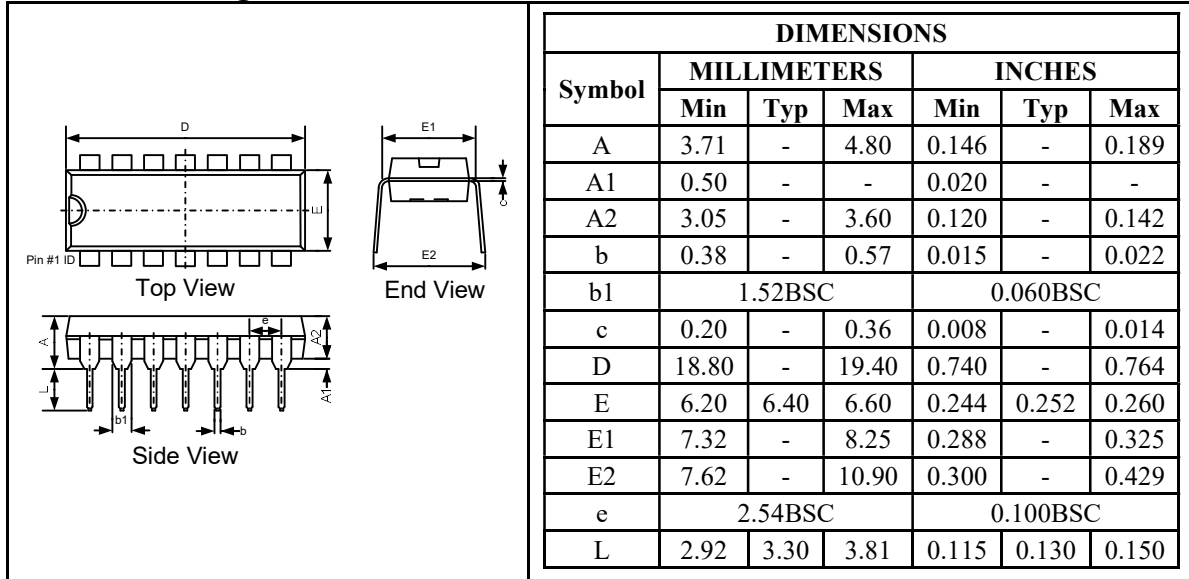

UM3491EEPE Union Semiconductor International Limited IC TRANSCEIVER FULL 1 V 1 420P

---

## GREEN COMPLIANCE

Union Semiconductor is committed to environmental excellence in all aspects of its operations including meeting or exceeding regulatory requirements with respect to the use of hazardous substances. Numerous successful programs have been implemented to reduce the use of hazardous substances and/or emissions.

All Union components are compliant with the RoHS directive, which helps to support customers in their compliance with environmental directives. For more green compliance information, please visit:

[http://www.union-ic.com/index.aspx?cat\\_code=RoHSDeclaration](http://www.union-ic.com/index.aspx?cat_code=RoHSDeclaration)

## IMPORTANT NOTICE

The information in this document has been carefully reviewed and is believed to be accurate. Nonetheless, this document is subject to change without notice. Union assumes no responsibility for any inaccuracies that may be contained in this document, and makes no commitment to update or to keep current the contained information, or to notify a person or organization of any update. Union reserves the right to make changes, at any time, in order to improve reliability, function or design and to attempt to supply the best product possible.

Union Semiconductor International Limited 2021年2月8日



Union Semiconductor, Inc

Add: Unit 606, No.570 Shengxia Road, Shanghai 201210

Tel: 021-51093966

Fax: 021-51026018

Website: [www.union-ic.com](http://www.union-ic.com)



## OUR CERTIFICATE

DiGi provide top-quality products and perfect service for customer worldwide through standardization, technological innovation and continuous improvement. DiGi through third-party certification, we stricly control the quality of products and services. Welcome your RFQ to

Email: [Info@DiGi-Electronics.com](mailto:Info@DiGi-Electronics.com)



Tel: +00 852-30501935

RFQ Email: [Info@DiGi-Electronics.com](mailto:Info@DiGi-Electronics.com)

DiGi is a global authorized distributor of electronic components.