

M6060P-E3/45 Datasheet

www.digi-electronics.com

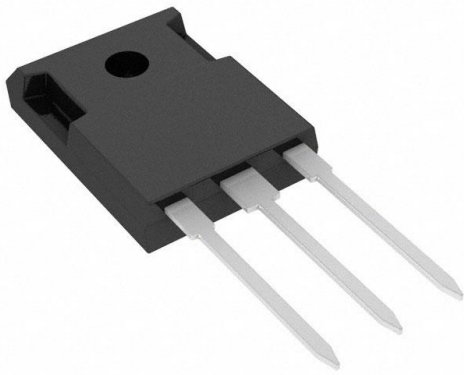

<https://www.DiGi-Electronics.com>

DiGi Electronics Part Number	M6060P-E3/45-DG
Manufacturer	Vishay General Semiconductor - Diodes Division
Manufacturer Product Number	M6060P-E3/45
Description	DIODE ARR SCHOTT 60V 30A TO247AD
Detailed Description	Diode Array 1 Pair Common Cathode 60 V 30A Through Hole TO-3P-3, SC-65-3

This model M6060P-E3/45 is available at DiGi Electronics.

DiGi Electronics offers a global database of semiconductor and electronic component datasheets.

We welcome your inquiries regarding pricing, lead time, or other product-related questions.

 [Request a Quote](#)

 [Datasheet Search](#)



Tel: +00 852-30501935

RFQ Email: Info@DiGi-Electronics.com

DiGi is a global authorized distributor of electronic components.

Purchase and inquiry

Manufacturer Product Number:

M6060P-E3/45

Series:

-

Diode Configuration:

1 Pair Common Cathode

Voltage - DC Reverse (Vr) (Max):

60 V

Voltage - Forward (Vf) (Max) @ If:

640 mV @ 30 A

Current - Reverse Leakage @ Vr:

600 μ A @ 60 V

Mounting Type:

Through Hole

Supplier Device Package:

TO-247AD (TO-3P)

Manufacturer:

Vishay General Semiconductor - Diodes Division

Product Status:

Active

Technology:

Schottky

Current - Average Rectified (Io) (per Diode):

30A

Speed:

Fast Recovery \leq 500ns, > 200mA (Io)

Operating Temperature - Junction:

-65°C ~ 150°C

Package / Case:

TO-3P-3, SC-65-3

Base Product Number:

M6060

Environmental & Export classification

RoHS Status:

ROHS3 Compliant

REACH Status:

REACH Unaffected

HTSUS:

8541.10.0080

Moisture Sensitivity Level (MSL):

1 (Unlimited)

ECCN:

EAR99

www.vishay.com
M6035P, M6045P, M6060P

Vishay General Semiconductor

Dual Common Cathode Schottky Rectifier

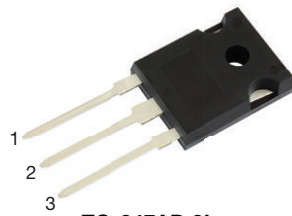
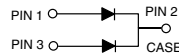
TO-247AD 3L

RoHS
 COMPLIANT
 HALOGEN
FREE

FEATURES

- Power pack
- Guardring for overvoltage protection
- Low power losses, high efficiency
- Low forward voltage drop
- High forward surge capability
- High frequency operation
- Solder dip 275 °C max.10 s, per JESD 22-B106
- Material categorization: for definitions of compliance please see www.vishay.com/doc?99912

TYPICAL APPLICATIONS

For use in low voltage, high frequency rectifier of switching mode power supplies, freewheeling diodes, DC/DC converters, or polarity protection application.

MECHANICAL DATA

Case: TO-247AD 3L

Molding compound meets UL 94 V-0 flammability rating Base P/N-M3 - RoHS-compliant, halogen-free, commercial grade

Terminals: matte tin plated leads, solderable per J-STD-002 and JESD 22-B102

M3 suffix meets JESD 201 class 1A whisker test

Polarity: as marked

Mounting Torque: 10 in-lbs maximum

PRIMARY CHARACTERISTICS	
$I_{F(AV)}$	2 x 30 A
V_{RRM}	35 V, 45 V, 60 V
I_{FSM}	350 A
V_F at $I_F = 30$ A	0.50 V, 0.56 V
T_J max.	150 °C
Package	TO-247AD 3L
Circuit configurations	Common cathode

MAXIMUM RATINGS ($T_A = 25$ °C unless otherwise noted)					
PARAMETER	SYMBOL	M6035P	M6045P	M6060P	UNIT
Maximum repetitive peak reverse voltage	V_{RRM}	35	45	60	V
Maximum average forward rectified current at (fig.1)	$I_{F(AV)}$	total device		60	A
		per diode		30	
Peak forward surge current 8.3 ms single half sine-wave superimposed on rated load per diode	I_{FSM}	350		A	
Peak repetitive reverse current at $t_p = 2$ μ s, 1 kHz per diode	I_{RRM}	2.0		A	
Voltage rate of change (rated V_R)	dV/dt	10 000		V/ μ s	
Operating junction and storage temperature range	T_J, T_{STG}	-65 to +150		°C	

www.vishay.com

M6035P, M6045P, M6060P

Vishay General Semiconductor

ELECTRICAL CHARACTERISTICS ($T_A = 25\text{ }^\circ\text{C}$ unless otherwise noted)									
PARAMETER	SYMBOL	TEST CONDITIONS		M6035P	M6045P	M6060P		UNIT	
				TYP.	MAX.	TYP.	MAX.		
Instantaneous forward voltage per diode	$V_F^{(1)}$	$I_F = 10\text{ A}$	$T_J = 25\text{ }^\circ\text{C}$	0.42	-	0.43	-	V	
				$I_F = 20\text{ A}$	0.49	-	0.52		-
				$I_F = 30\text{ A}$	0.54	0.60	0.59		0.64
		$I_F = 10\text{ A}$	$T_J = 125\text{ }^\circ\text{C}$	0.31	-	0.33	-		
				$I_F = 20\text{ A}$	0.42	-	0.47		-
				$I_F = 30\text{ A}$	0.50	0.55	0.56		0.60
Reverse current per diode	$I_R^{(2)}$	V_R	$T_J = 25\text{ }^\circ\text{C}$	135	600	240	600	μA	
			$T_J = 125\text{ }^\circ\text{C}$	110	160	140	160	mA	
Typical junction capacitance	C_J	4.0 V, 1 MHz		1150	-	1090	-	pF	

Notes

 (1) Pulse test: 300 μs pulse width, 1 % duty cycle

 (2) Pulse test: Pulse width $\leq 40\text{ ms}$

THERMAL CHARACTERISTICS ($T_A = 25\text{ }^\circ\text{C}$ unless otherwise noted)					
PARAMETER	SYMBOL	M6035P	M6045P	M6060P	UNIT
Typical thermal resistance per diode	$R_{\theta JC}$	2.0			$^\circ\text{C/W}$

ORDERING INFORMATION (Example)				
PREFERRED P/N	UNIT WEIGHT (g)	PREFERRED PACKAGE CODE	BASE QUANTITY	DELIVERY MODE
M6045P-M3/P	5.83	P	25/tube	Tube
M6060P-M3/P	5.83	P	25/tube	Tube



M6035P, M6045P, M6060P

Vishay General Semiconductor

RATINGS AND CHARACTERISTICS CURVES ($T_A = 25\text{ }^\circ\text{C}$ unless otherwise noted)

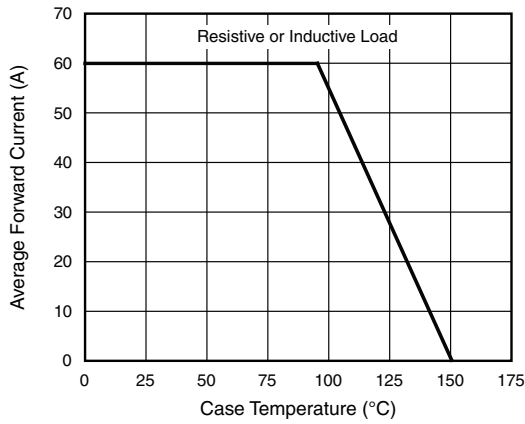

Fig. 1 - Forward Current Derating Curve

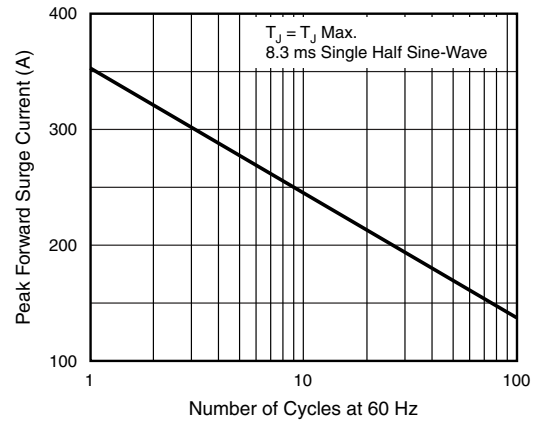

Fig. 4 - Maximum Non-Repetitive Peak Forward Surge Current Per Diode

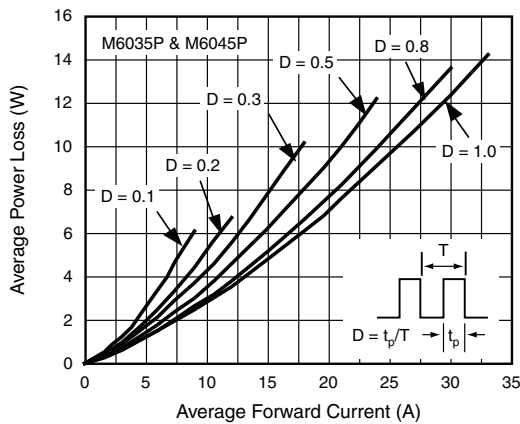

Fig. 2 - Forward Power Loss Characteristics Per Diode

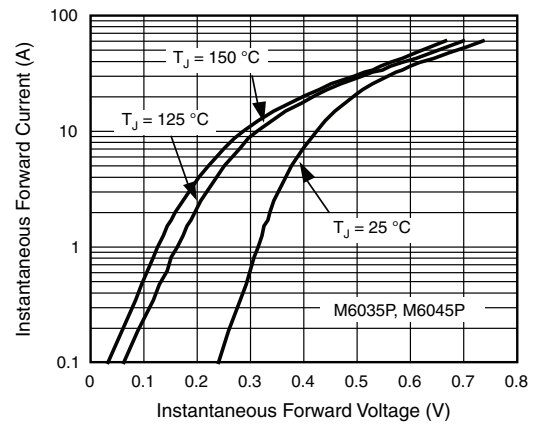

Fig. 5 - Typical Instantaneous Forward Characteristics Per Diode

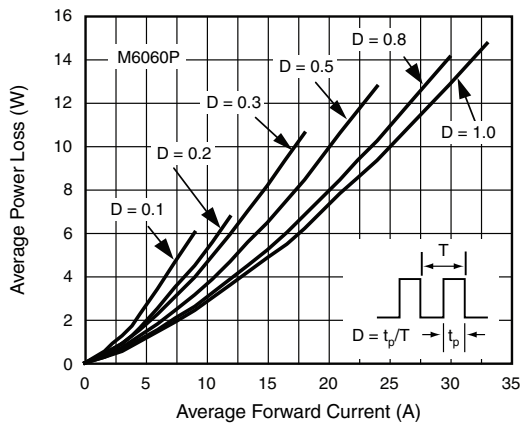

Fig. 3 - Forward Power Loss Characteristics Per Diode

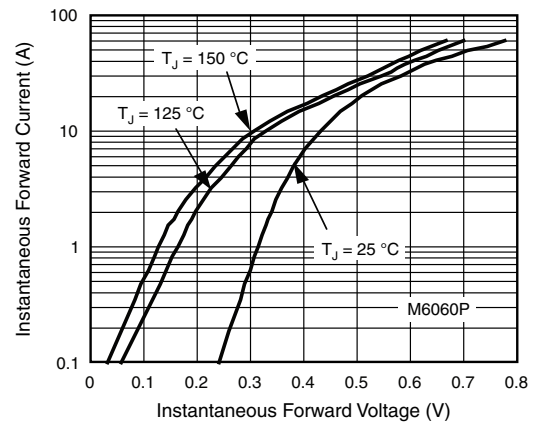

Fig. 6 - Typical Instantaneous Forward Characteristics Per Diode



M6035P, M6045P, M6060P

Vishay General Semiconductor

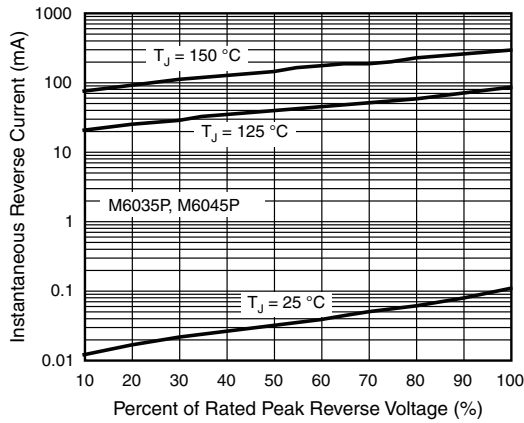

Fig. 7 - Typical Reverse Characteristics Per Diode

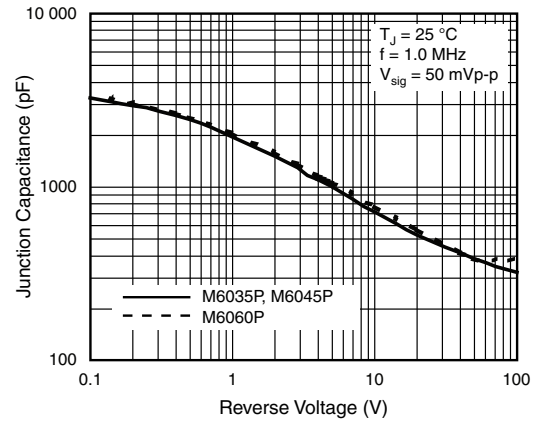

Fig. 9 - Typical Junction Capacitance Per Diode

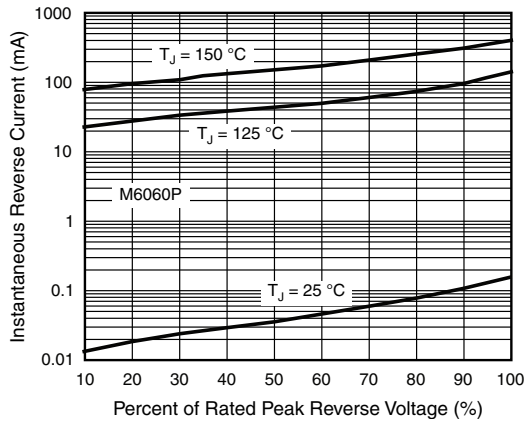

Fig. 8 - Typical Reverse Characteristics Per Diode

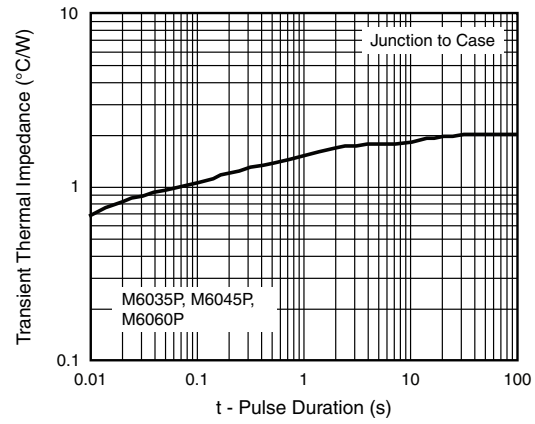

Fig. 10 - Typical Transient Thermal Impedance Per Diode



www.vishay.com

M6035P, M6045P, M6060P

Vishay General Semiconductor

PACKAGE OUTLINE DIMENSIONS in millimeters (inches) TO-247AD 3L

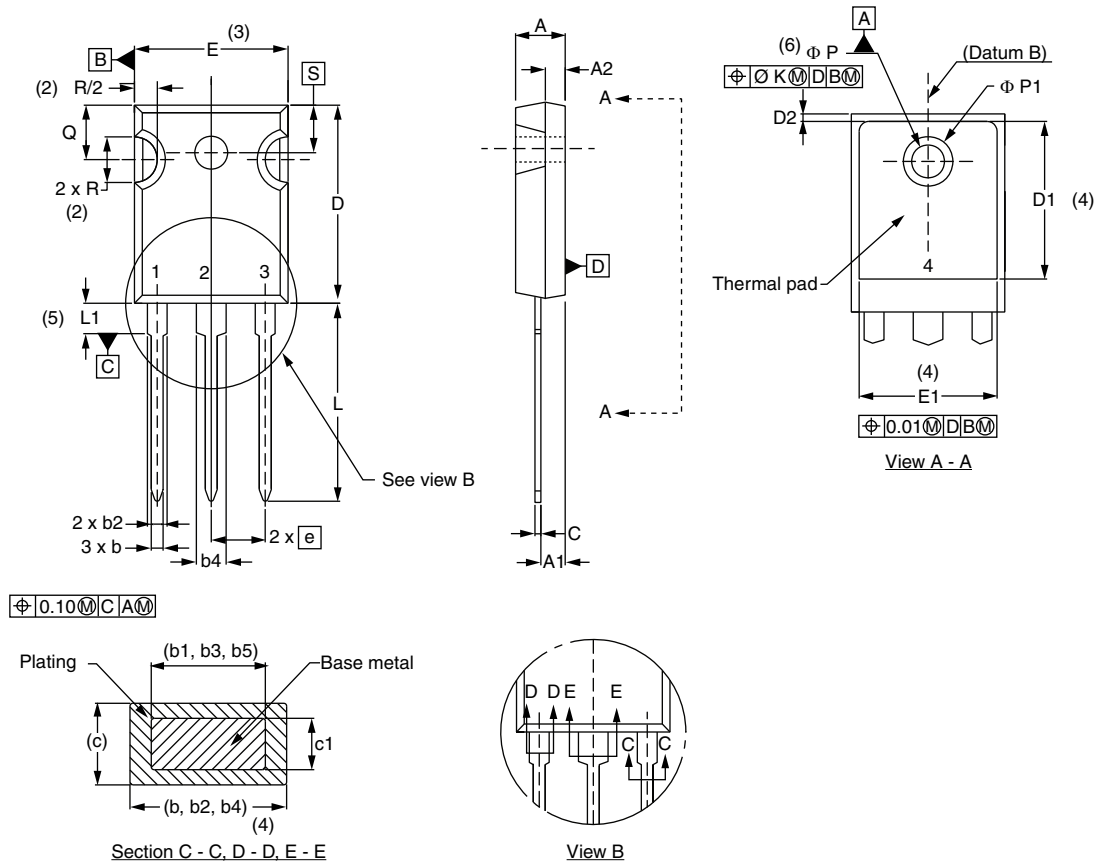

SYMBOL	MILLIMETERS		INCHES		NOTES	SYMBOL	MILLIMETERS		INCHES		NOTES
	MIN.	MAX.	MIN.	MAX.			MIN.	MAX.	MIN.	MAX.	
A	4.65	5.31	0.183	0.209		D2	0.51	1.30	0.020	0.051	
A1	2.21	2.59	0.087	0.102		E	15.29	15.87	0.602	0.625	3
A2	1.50	2.49	0.059	0.098		E1	13.46	-	0.53	-	
b	0.99	1.40	0.039	0.055		e	5.46 BSC		0.215 BSC		
b1	0.99	1.35	0.039	0.053		ϕK	0.254		0.010		
b2	1.65	2.39	0.065	0.094		L	19.81	20.32	0.780	0.800	
b3	1.65	2.34	0.065	0.092		L1	3.71	4.29	0.146	0.169	
b4	2.59	3.43	0.102	0.135		ϕP	3.56	3.66	0.14	0.144	
b5	2.59	3.38	0.102	0.133		$\phi P1$	-	6.98	-	0.275	
c	0.38	0.89	0.015	0.035		Q	5.31	5.69	0.209	0.224	
c1	0.38	0.84	0.015	0.033		R	4.52	5.49	0.178	0.216	
D	19.71	20.70	0.776	0.815	3	S	5.51 BSC		0.217 BSC		
D1	13.08	-	0.515	-	4						

Notes

- (1) Dimensioning and tolerancing per ASME Y14.5M-1994
- (2) Contour of slot optional
- (3) Dimension D and E do not include mold flash. These dimensions are measured at the outermost extremes of the plastic body
- (4) Thermal pad contour optional with dimensions D1 and E1
- (5) Lead finish uncontrolled in L1
- (6) ϕP to have a maximum draft angle of 1.5 to the top of the part with a maximum hole diameter of 3.91 mm (0.154")
- (7) Outline conforms to JEDEC® outline TO-247 with exception of dimension A min., D, E min., Q min., S, and note 4



Disclaimer

ALL PRODUCT, PRODUCT SPECIFICATIONS AND DATA ARE SUBJECT TO CHANGE WITHOUT NOTICE TO IMPROVE RELIABILITY, FUNCTION OR DESIGN OR OTHERWISE.

Vishay Intertechnology, Inc., its affiliates, agents, and employees, and all persons acting on its or their behalf (collectively, "Vishay"), disclaim any and all liability for any errors, inaccuracies or incompleteness contained in any datasheet or in any other disclosure relating to any product.

Vishay makes no warranty, representation or guarantee regarding the suitability of the products for any particular purpose or the continuing production of any product. To the maximum extent permitted by applicable law, Vishay disclaims (i) any and all liability arising out of the application or use of any product, (ii) any and all liability, including without limitation special, consequential or incidental damages, and (iii) any and all implied warranties, including warranties of fitness for particular purpose, non-infringement and merchantability.

Statements regarding the suitability of products for certain types of applications are based on Vishay's knowledge of typical requirements that are often placed on Vishay products in generic applications. Such statements are not binding statements about the suitability of products for a particular application. It is the customer's responsibility to validate that a particular product with the properties described in the product specification is suitable for use in a particular application. Parameters provided in datasheets and / or specifications may vary in different applications and performance may vary over time. All operating parameters, including typical parameters, must be validated for each customer application by the customer's technical experts. Product specifications do not expand or otherwise modify Vishay's terms and conditions of purchase, including but not limited to the warranty expressed therein.

Hyperlinks included in this datasheet may direct users to third-party websites. These links are provided as a convenience and for informational purposes only. Inclusion of these hyperlinks does not constitute an endorsement or an approval by Vishay of any of the products, services or opinions of the corporation, organization or individual associated with the third-party website. Vishay disclaims any and all liability and bears no responsibility for the accuracy, legality or content of the third-party website or for that of subsequent links.

Vishay products are not designed for use in life-saving or life-sustaining applications or any application in which the failure of the Vishay product could result in personal injury or death unless specifically qualified in writing by Vishay. Customers using or selling Vishay products not expressly indicated for use in such applications do so at their own risk. Please contact authorized Vishay personnel to obtain written terms and conditions regarding products designed for such applications.

No license, express or implied, by estoppel or otherwise, to any intellectual property rights is granted by this document or by any conduct of Vishay. Product names and markings noted herein may be trademarks of their respective owners.

OUR CERTIFICATE

DiGi provide top-quality products and perfect service for customer worldwide through standardization, technological innovation and continuous improvement. DiGi through third-party certification, we stricly control the quality of products and services. Welcome your RFQ to

Email: Info@DiGi-Electronics.com



Tel: +00 852-30501935

RFQ Email: Info@DiGi-Electronics.com

DiGi is a global authorized distributor of electronic components.