

S5BHE3/9AT Datasheet

www.digi-electronics.com



<https://www.DiGi-Electronics.com>

DiGi Electronics Part Number	S5BHE3/9AT-DG
Manufacturer	Vishay General Semiconductor - Diodes Division
Manufacturer Product Number	S5BHE3/9AT
Description	DIODE GEN PURP 100V 5A DO214AB
Detailed Description	Diode 100 V 5A Surface Mount DO-214AB (SMC)

This model S5BHE3/9AT is available at DiGi Electronics.

DiGi Electronics offers a global database of semiconductor and electronic component datasheets.

We welcome your inquiries regarding pricing, lead time, or other product-related questions.

 [Request a Quote](#)

 [Datasheet Search](#)



Tel: +00 852-30501935

RFQ Email: Info@DiGi-Electronics.com

DiGi is a global authorized distributor of electronic components.

Purchase and inquiry

Manufacturer Product Number:

S5BHE3/9AT

Series:

-

Technology:

Standard

Current - Average Rectified (Io):

5A

Speed:

Standard Recovery >500ns, > 200mA (Io)

Current - Reverse Leakage @ Vr:

10 μ A @ 100 V

Grade:

Automotive

Mounting Type:

Surface Mount

Supplier Device Package:

DO-214AB (SMC)

Base Product Number:

S5B

Manufacturer:

Vishay General Semiconductor - Diodes Division

Product Status:

Obsolete

Voltage - DC Reverse (Vr) (Max):

100 V

Voltage - Forward (Vf) (Max) @ If:

1.15 V @ 5 A

Reverse Recovery Time (trr):

2.5 μ s

Capacitance @ Vr, F:

40pF @ 4V, 1MHz

Qualification:

AEC-Q101

Package / Case:

DO-214AB, SMC

Operating Temperature - Junction:

-55°C ~ 150°C

Environmental & Export classification

RoHS Status:

ROHS3 Compliant

REACH Status:

REACH Unaffected

HTSUS:

8541.10.0080

Moisture Sensitivity Level (MSL):

1 (Unlimited)

ECCN:

EAR99

www.vishay.com

S5A, S5B, S5D, S5G, S5J, S5K, S5M

Vishay General Semiconductor

Surface-Mount Glass Passivated Rectifier



SMC (DO-214AB)

Cathode  Anode

LINKS TO ADDITIONAL RESOURCES



3D Models

PRIMARY CHARACTERISTICS	
$I_{F(AV)}$	5.0 A
V_{RRM}	50 V, 100 V, 200 V, 400 V, 600 V, 800 V, 1000 V
I_{FSM}	100 A
I_R	10 μ A
V_F	1.15 V
T_J max.	175 °C
Package	SMC (DO-214AB)
Circuit configuration	Single

FEATURES

- Low profile package
- Ideal for automated placement
- Glass passivated pellet chip junction
- Low forward voltage drop
- Low leakage current
- High forward surge capability
- Meets MSL level 1, per J-STD-020, LF maximum peak of 260 °C
- AEC-Q101 qualified available
 - Automotive ordering code: base P/NHE3 or P/NHM3
- Material categorization: for definitions of compliance please see www.vishay.com/doc?99912

 AUTOMOTIVE
GRADE
Available

 RoHS
COMPLIANT
HALOGEN
FREE

TYPICAL APPLICATIONS

For use in general purpose rectification of power supplies, inverters, converters and freewheeling diodes for consumer, automotive and telecommunication.

MECHANICAL DATA

Case: SMC (DO-214AB)

Molding compound meets UL 94 V-0 flammability rating

Base P/N-E3 - RoHS-compliant, commercial grade

Base P/N-M3 - halogen-free, RoHS-compliant, commercial grade

Base P/NHE3_X - RoHS-compliant and AEC-Q101 qualified ("_X" denotes revision code e.g. A, B,....)

Terminals: matte tin plated leads, solderable per J-STD-002 and JESD 22-B102

E3, M3, and HE3 suffix meets JESD 201 class 2 whisker test

Polarity: color band denotes cathode end

MAXIMUM RATINGS ($T_A = 25$ °C unless otherwise noted)									
PARAMETER	SYMBOL	S5A	S5B	S5D	S5G	S5J	S5K	S5M	UNIT
Device marking code		5A	5B	5D	5G	5J	5K	5M	
Maximum repetitive peak reverse voltage	V_{RRM}	50	100	200	400	600	800	1000	V
Maximum RMS voltage	V_{RMS}	35	70	140	280	420	560	700	V
Maximum DC blocking voltage	V_{DC}	50	100	200	400	600	800	1000	V
Maximum average forward rectified current at $T_L = 100$ °C	$I_{F(AV)}$	5.0							A
Peak forward surge current 8.3 ms single half sine-wave superimposed on rated load	I_{FSM}	100							A
Operating junction and storage temperature range	T_J, T_{STG}	-55 to +175							°C

www.vishay.com

S5A, S5B, S5D, S5G, S5J, S5K, S5M

Vishay General Semiconductor

ELECTRICAL CHARACTERISTICS ($T_A = 25\text{ }^\circ\text{C}$ unless otherwise noted)											
PARAMETER	TEST CONDITIONS	SYMBOL	S5A	S5B	S5D	S5G	S5J	S5K	S5M	UNIT	
Maximum instantaneous forward voltage	5.0 A	V_F	1.15								V
Maximum DC reverse current at rated DC blocking voltage	$T_J = 25\text{ }^\circ\text{C}$	I_R	10								μA
	$T_J = 125\text{ }^\circ\text{C}$		250								
Typical reverse recovery time	$I_F = 0.5\text{ A}$, $I_R = 1.0\text{ A}$, $I_{rr} = 0.25\text{ A}$	t_{rr}	2.5								μs
Typical junction capacitance	4.0 V, 1 MHz	C_J	40								pF

THERMAL CHARACTERISTICS ($T_A = 25\text{ }^\circ\text{C}$ unless otherwise noted)										
PARAMETER	SYMBOL	S5A	S5B	S5D	S5G	S5J	S5K	S5M	UNIT	
Typical thermal resistance ⁽¹⁾	$R_{\theta JL}$	10								$^\circ\text{C/W}$

Note

(1) Thermal resistance from junction to lead mounted on PCB with 0.3" x 0.3" (8.0 mm x 8.0 mm) copper pad area

ORDERING INFORMATION (Example)				
PREFERRED P/N	UNIT WEIGHT (g)	PREFERRED PACKAGE CODE	BASE QUANTITY	DELIVERY MODE
S5J-E3/57T	0.211	57T	850	7" diameter plastic tape and reel
S5J-E3/9AT	0.211	9AT	3500	13" diameter plastic tape and reel
S5J-M3/57T	0.211	57T	850	7" diameter plastic tape and reel
S5J-M3/9AT	0.211	9AT	3500	13" diameter plastic tape and reel
S5JHE3_A/H ⁽¹⁾	0.211	H	850	7" diameter plastic tape and reel
S5JHE3_A/I ⁽¹⁾	0.211	I	3500	13" diameter plastic tape and reel

Note

(1) AEC-Q101 qualified

RATINGS AND CHARACTERISTICS CURVES ($T_A = 25\text{ }^\circ\text{C}$ unless otherwise noted)

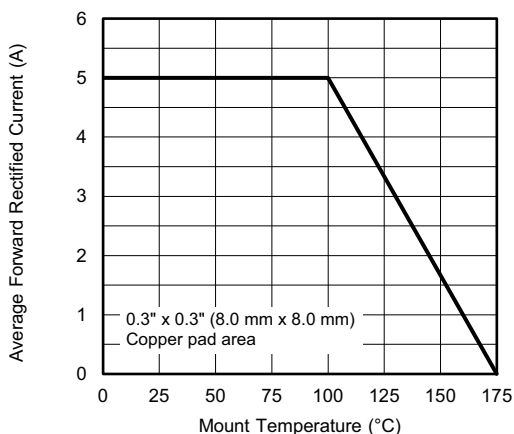

Fig. 1 - Forward Current Derating Curve

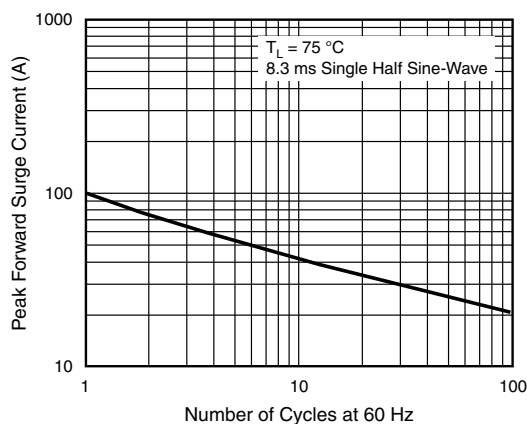

Fig. 2 - Maximum Non-Repetitive Peak Forward Surge Current



S5A, S5B, S5D, S5G, S5J, S5K, S5M

Vishay General Semiconductor

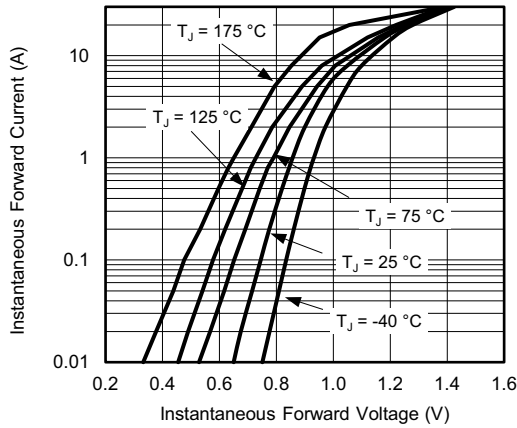

Fig. 3 - Typical Instantaneous Forward Characteristics

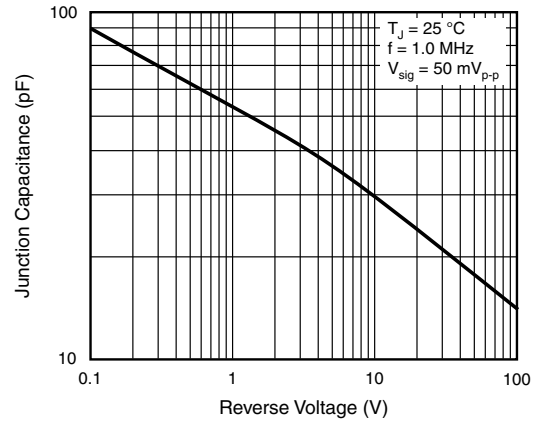

Fig. 5 - Typical Junction Capacitance

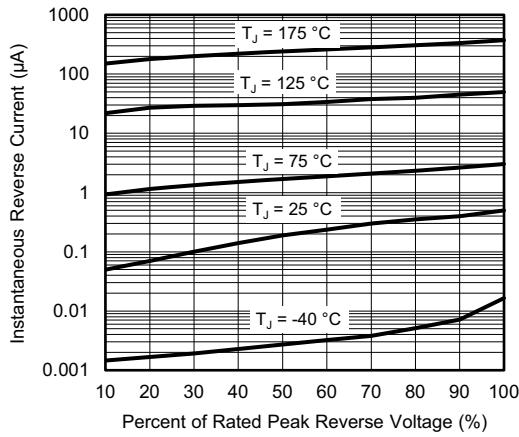
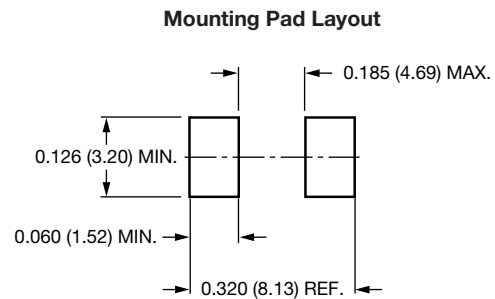
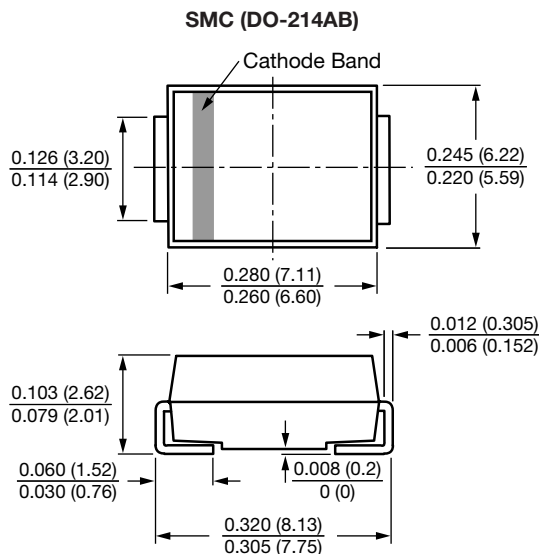

Fig. 4 - Typical Reverse Characteristics

PACKAGE OUTLINE DIMENSIONS in inches (millimeters)





Disclaimer

ALL PRODUCT, PRODUCT SPECIFICATIONS AND DATA ARE SUBJECT TO CHANGE WITHOUT NOTICE TO IMPROVE RELIABILITY, FUNCTION OR DESIGN OR OTHERWISE.

Vishay Intertechnology, Inc., its affiliates, agents, and employees, and all persons acting on its or their behalf (collectively, "Vishay"), disclaim any and all liability for any errors, inaccuracies or incompleteness contained in any datasheet or in any other disclosure relating to any product.

Vishay makes no warranty, representation or guarantee regarding the suitability of the products for any particular purpose or the continuing production of any product. To the maximum extent permitted by applicable law, Vishay disclaims (i) any and all liability arising out of the application or use of any product, (ii) any and all liability, including without limitation special, consequential or incidental damages, and (iii) any and all implied warranties, including warranties of fitness for particular purpose, non-infringement and merchantability.

Statements regarding the suitability of products for certain types of applications are based on Vishay's knowledge of typical requirements that are often placed on Vishay products in generic applications. Such statements are not binding statements about the suitability of products for a particular application. It is the customer's responsibility to validate that a particular product with the properties described in the product specification is suitable for use in a particular application. Parameters provided in datasheets and / or specifications may vary in different applications and performance may vary over time. All operating parameters, including typical parameters, must be validated for each customer application by the customer's technical experts. Product specifications do not expand or otherwise modify Vishay's terms and conditions of purchase, including but not limited to the warranty expressed therein.

Hyperlinks included in this datasheet may direct users to third-party websites. These links are provided as a convenience and for informational purposes only. Inclusion of these hyperlinks does not constitute an endorsement or an approval by Vishay of any of the products, services or opinions of the corporation, organization or individual associated with the third-party website. Vishay disclaims any and all liability and bears no responsibility for the accuracy, legality or content of the third-party website or for that of subsequent links.

Vishay products are not designed for use in life-saving or life-sustaining applications or any application in which the failure of the Vishay product could result in personal injury or death unless specifically qualified in writing by Vishay. Customers using or selling Vishay products not expressly indicated for use in such applications do so at their own risk. Please contact authorized Vishay personnel to obtain written terms and conditions regarding products designed for such applications.

No license, express or implied, by estoppel or otherwise, to any intellectual property rights is granted by this document or by any conduct of Vishay. Product names and markings noted herein may be trademarks of their respective owners.

OUR CERTIFICATE

DiGi provide top-quality products and perfect service for customer worldwide through standardization, technological innovation and continuous improvement. DiGi through third-party certification, we stricly control the quality of products and services. Welcome your RFQ to

Email: Info@DiGi-Electronics.com



Tel: +00 852-30501935

RFQ Email: Info@DiGi-Electronics.com

DiGi is a global authorized distributor of electronic components.