

TLZ6V2B-GS08 Datasheet

www.digi-electronics.com



<https://www.DiGi-Electronics.com>

DiGi Electronics Part Number	TLZ6V2B-GS08-DG
Manufacturer	Vishay General Semiconductor - Diodes Division
Manufacturer Product Number	TLZ6V2B-GS08
Description	DIODE ZENER 6.2V 500MW SOD80
Detailed Description	Zener Diode 6.2 V 500 mW Surface Mount SOD-80 M iniMELF

This model TLZ6V2B-GS08 is available at DiGi Electronics.

DiGi Electronics offers a global database of semiconductor and electronic component datasheets.

We welcome your inquiries regarding pricing, lead time, or other product-related questions.

 [Request a Quote](#)

 [Datasheet Search](#)



Tel: +00 852-30501935

RFQ Email: Info@DiGi-Electronics.com

DiGi is a global authorized distributor of electronic components.

Purchase and inquiry

Manufacturer Product Number:

TLZ6V2B-GS08

Series:

TLZ

Voltage - Zener (Nom) (Vz):

6.2 V

Power - Max:

500 mW

Current - Reverse Leakage @ Vr:

3 μ A @ 4 V

Operating Temperature:

-65°C ~ 175°C

Package / Case:

DO-213AC, MINI-MELF, SOD-80

Base Product Number:

TLZ6V2

Manufacturer:

Vishay General Semiconductor - Diodes Division

Product Status:

Active

Tolerance:

-

Impedance (Max) (Zzt):

10 Ohms

Voltage - Forward (Vf) (Max) @ If:

1.5 V @ 200 mA

Mounting Type:

Surface Mount

Supplier Device Package:

SOD-80 MiniMELF

Environmental & Export classification

RoHS Status:

ROHS3 Compliant

REACH Status:

REACH Unaffected

HTSUS:

8541.10.0050

Moisture Sensitivity Level (MSL):

1 (Unlimited)

ECCN:

EAR99



Small Signal Zener Diodes



FEATURES

- Very sharp reverse characteristic
- Low reverse current level
- Very high stability
- Low noise
- High reliability
- Material categorization:
for definitions of compliance please see
www.vishay.com/doc?99912



RoHS
COMPLIANT
HALOGEN
FREE

LINKS TO ADDITIONAL RESOURCES



APPLICATIONS

- Voltage stabilization

PRIMARY CHARACTERISTICS

PARAMETER	VALUE	UNIT
V _Z range nom.	2.4 to 56	V
Test current I _{ZT}	5 to 20	mA
V _Z specification	Pulse current	
Circuit configuration	Single	

ORDERING INFORMATION

DEVICE NAME	ORDERING CODE	TAPED UNITS PER REEL	MINIMUM ORDER QUANTITY
TLZ-series	TLZ-series-GS18	10 000 (8 mm tape on 13" reel)	10 000/box
TLZ-series	TLZ-series-GS08	2500 (8 mm tape on 7" reel)	12 500/box

PACKAGE

PACKAGE NAME	WEIGHT	MOLDING COMPOUND FLAMMABILITY RATING	MOISTURE SENSITIVITY LEVEL	SOLDERING CONDITIONS
MiniMELF (SOD-80)	approx. 31 mg	UL 94 V-0	MSL level 1 (according J-STD-020)	Peak temperature max. 260 °C

ABSOLUTE MAXIMUM RATINGS (T_{amb} = 25 °C, unless otherwise specified)

PARAMETER	TEST CONDITION	SYMBOL	VALUE	UNIT
Power dissipation	R _{thJA} ≤ 300 K/W	P _{tot}	500	mW
Zener current		I _Z	P _{tot} /V _Z	mA
Junction to ambient air	On PC board 50 mm x 50 mm x 1.6 mm	R _{thJA}	500	K/W
Junction temperature		T _J	175	°C
Storage temperature range		T _{stg}	-65 to +175	°C
Forward voltage (max.)	I _F = 200 mA	V _F	1.5	V



ELECTRICAL CHARACTERISTICS ($T_{amb} = 25\text{ }^{\circ}\text{C}$, unless otherwise specified)									
PART NUMBER	MARKING CODE	ZENER VOLTAGE RANGE		TEST CURRENT		REVERSE LEAKAGE CURRENT		DYNAMIC RESISTANCE	
		V_Z at I_{ZT1}		I_{ZT1}	I_{ZT2}	I_R at V_R		Z_Z at I_{ZT1}	Z_{ZK} at I_{ZT2}
		V		mA		μA	V	Ω	
		MIN.	MAX.			MAX.		MAX.	MAX.
TLZ2V4A	2A4	2.33	2.52	20	1	70	1	100	2000
TLZ2V4B	2B4	2.43	2.63	20	1	70	1	100	2000
TLZ2V7A	2A7	2.54	2.75	20	1	50	1	100	1000
TLZ2V7B	2B7	2.69	2.91	20	1	50	1	100	1000
TLZ3V0A	3A0	2.85	3.07	20	1	50	1	80	1000
TLZ3V0B	3B0	3.01	3.22	20	1	10	1	80	1000
TLZ3V3A	3A3	3.16	3.38	20	1	10	1	70	1000
TLZ3V3B	3B3	3.32	3.53	20	1	10	1	70	1000
TLZ3V6A	3A6	3.455	3.695	20	1	5	1	60	1000
TLZ3V6B	3B6	3.6	3.845	20	1	5	1	60	1000
TLZ3V9A	3A9	3.74	4.01	20	1	3	1	50	1000
TLZ3V9B	3B9	3.89	4.16	20	1	3	1	50	1000
TLZ4V3A	4A3	4.04	4.29	20	1	3	1	40	1000
TLZ4V3B	4B3	4.17	4.43	20	1	3	1	40	1000
TLZ4V3C	4C3	4.3	4.57	20	1	3	1	40	1000
TLZ4V7A	4A7	4.44	4.68	20	1	5	1	25	900
TLZ4V7B	4B7	4.55	4.8	20	1	5	1	25	900
TLZ4V7C	4C7	4.68	4.93	20	1	5	1	25	900
TLZ5V1A	5A1	4.81	5.07	20	1	2	2	20	800
TLZ5V1B	5B1	4.94	5.2	20	1	2	2	20	800
TLZ5V1C	5C1	5.09	5.37	20	1	2	2	20	800
TLZ5V6A	5A6	5.28	5.55	20	1	1	2	13	500
TLZ5V6B	5B6	5.45	5.73	20	1	1	2	13	500
TLZ5V6C	5C6	5.61	5.91	20	1	1	2	13	500
TLZ6V2A	6A2	5.78	6.09	20	1	3	4	10	300
TLZ6V2B	6B2	5.96	6.27	20	1	3	4	10	300
TLZ6V2C	6C2	6.12	6.44	20	1	3	4	10	300
TLZ6V8A	6A8	6.29	6.63	20	0.5	2	4	8	150
TLZ6V8B	6B8	6.49	6.83	20	0.5	2	4	8	150
TLZ6V8C	6C8	6.66	7.01	20	0.5	2	4	8	150
TLZ7V5A	7A5	6.85	7.22	20	0.5	3	6.5	8	120
TLZ7V5B	7B5	7.07	7.45	20	0.5	3	6.73	8	120
TLZ7V5C	7C5	7.29	7.67	20	0.5	3	6.93	8	120
TLZ8V2A	8A2	7.53	7.92	20	0.5	7.5	7.15	8	120
TLZ8V2B	8B2	7.78	8.19	20	0.5	7.5	7.39	8	120
TLZ8V2C	8C2	8.03	8.45	20	0.5	7.5	7.63	8	120
TLZ9V1A	9A1	8.29	8.73	20	0.5	0.04	7.88	8	120
TLZ9V1B	9B1	8.57	9.01	20	0.5	0.04	8.14	8	120
TLZ9V1C	9C1	8.83	9.3	20	0.5	0.04	8.39	8	120
TLZ10A	10A	9.12	9.59	20	0.5	0.04	8.66	8	120
TLZ10B	10B	9.41	9.9	20	0.5	0.04	8.94	8	120
TLZ10C	10C	9.7	10.2	20	0.5	0.04	9.22	8	120
TLZ10D	10D	9.94	10.44	20	0.5	0.04	9.44	8	120



ELECTRICAL CHARACTERISTICS ($T_{amb} = 25\text{ }^{\circ}\text{C}$, unless otherwise specified)									
PART NUMBER	MARKING CODE	ZENER VOLTAGE RANGE		TEST CURRENT		REVERSE LEAKAGE CURRENT		DYNAMIC RESISTANCE	
		V_Z at I_{ZT1}		I_{ZT1}	I_{ZT2}	I_R at V_R		Z_Z at I_{ZT1}	Z_{ZK} at I_{ZT2}
		V		mA		μA	V	Ω	
		MIN.	MAX.			MAX.		MAX.	MAX.
TLZ11A	11A	10.18	10.71	10	0.5	0.04	9.67	10	120
TLZ11B	11B	10.5	11.05	10	0.5	0.04	9.98	10	120
TLZ11C	11C	10.82	11.38	10	0.5	0.04	10.28	10	120
TLZ12A	12A	11.13	11.71	10	0.5	0.04	10.6	12	110
TLZ12B	12B	11.44	12.03	10	0.5	0.04	10.9	12	110
TLZ12C	12C	11.74	12.35	10	0.5	0.04	11.2	12	110
TLZ13A	13A	12.11	12.75	10	0.5	0.04	11.5	14	110
TLZ13B	13B	12.55	13.21	10	0.5	0.04	11.9	14	110
TLZ13C	13C	12.99	13.66	10	0.5	0.04	12.3	14	110
TLZ15A	15A	13.44	14.13	10	0.5	0.04	12.8	16	110
TLZ15B	15B	13.89	14.62	10	0.5	0.04	13.2	16	110
TLZ15C	15C	14.35	15.09	10	0.5	0.04	13.6	16	110
TLZ16A	16A	14.8	15.57	10	0.5	0.04	14.1	18	150
TLZ16B	16B	15.25	16.04	10	0.5	0.04	14.5	18	150
TLZ16C	16C	15.69	16.51	10	0.5	0.04	14.9	18	150
TLZ18A	18A	16.22	17.06	10	0.5	0.04	15.4	23	150
TLZ18B	18B	16.82	17.7	10	0.5	0.04	16	23	150
TLZ18C	18C	17.42	18.33	10	0.5	0.04	16.5	23	150
TLZ20A	20A	18.02	18.96	10	0.5	0.04	17.1	28	200
TLZ20B	20B	18.63	19.59	10	0.5	0.04	17.7	28	200
TLZ20C	20C	19.23	20.22	10	0.5	0.04	18.3	28	200
TLZ20D	20D	19.72	20.72	10	0.5	0.04	18.7	28	200
TLZ22A	22A	20.15	21.2	5	0.5	0.04	19.1	30	200
TLZ22B	22B	20.64	21.71	5	0.5	0.04	19.6	30	200
TLZ22C	22C	21.08	22.17	5	0.5	0.04	20	30	200
TLZ22D	22D	21.52	22.63	5	0.5	0.04	20.4	30	200
TLZ24A	24A	22.05	23.18	5	0.5	0.04	20.9	35	200
TLZ24B	24B	22.61	23.77	5	0.5	0.04	21.5	35	200
TLZ24C	24C	23.12	24.31	5	0.5	0.04	22	35	200
TLZ24D	24D	23.63	24.85	5	0.5	0.04	22.4	35	200
TLZ27A	27A	24.26	25.52	5	0.5	0.04	23	45	250
TLZ27B	27B	24.97	26.26	5	0.5	0.04	23.7	45	250
TLZ27C	27C	25.63	26.95	5	0.5	0.04	24.3	45	250
TLZ27D	27D	26.29	27.64	5	0.5	0.04	25	45	250
TLZ30A	30A	26.99	28.39	5	0.5	0.04	25.6	55	250
TLZ30B	30B	27.7	29.13	5	0.5	0.04	26.3	55	250
TLZ30C	30C	28.36	29.82	5	0.5	0.04	26.9	55	250
TLZ30D	30D	29.02	30.51	5	0.5	0.04	27.6	55	250
TLZ33A	33A	29.68	31.22	5	0.5	0.04	28.2	65	250
TLZ33B	33B	30.32	31.88	5	0.5	0.04	28.8	65	250
TLZ33C	33C	30.9	32.5	5	0.5	0.04	29.4	65	250
TLZ33D	33D	31.49	33.11	5	0.5	0.04	29.9	65	250
TLZ36A	36A	32.14	33.79	5	0.5	0.04	30.5	75	250
TLZ36B	36B	32.79	34.49	5	0.5	0.04	31.2	75	250
TLZ36C	36C	33.4	35.13	5	0.5	0.04	31.7	75	250
TLZ36D	36D	34.01	35.77	5	0.5	0.04	32.3	75	250



ELECTRICAL CHARACTERISTICS (T _{amb} = 25 °C, unless otherwise specified)									
PART NUMBER	MARKING CODE	ZENER VOLTAGE RANGE		TEST CURRENT		REVERSE LEAKAGE CURRENT		DYNAMIC RESISTANCE	
		V _Z at I _{ZT1}		I _{ZT1}	I _{ZT2}	I _R at V _R		Z _Z at I _{ZT1}	Z _{ZK} at I _{ZT2}
		V		mA		μA	V	Ω	
		MIN.	MAX.			MAX.		MAX.	MAX.
TLZ39A	39A	34.68	36.47	5	0.5	0.04	32.9	85	250
TLZ39B	39B	35.36	37.19	5	0.5	0.04	33.6	85	250
TLZ39C	39C	36	37.85	5	0.5	0.04	34.2	85	250
TLZ39D	39D	36.63	38.52	5	0.5	0.04	34.8	85	250
TLZ39E	39E	37.36	39.29	5	0.5	0.04	35.5	85	250
TLZ39F	39F	38.14	40.11	5	0.5	0.04	36.2	85	250
TLZ39G	39G	38.94	40.8	5	0.5	0.04	37	85	250
TLZ43	43	40	45	5	-	0.04	38	90	-
TLZ47	47	44	49	5	-	0.04	41.8	90	-
TLZ51	51	48	54	5	-	0.04	45.6	100	-
TLZ56	56	53	60	5	-	0.04	50.4	100	-

BASIC CHARACTERISTICS (T_{amb} = 25 °C, unless otherwise specified)

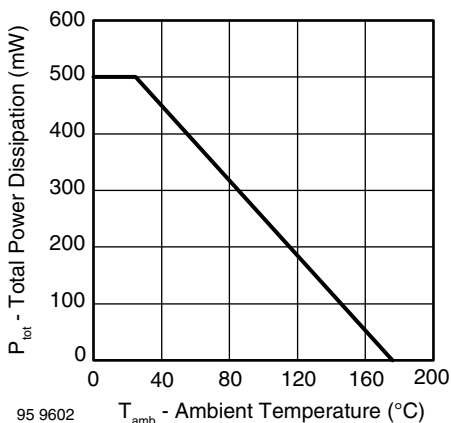

Fig. 1 - Total Power Dissipation vs. Ambient Temperature

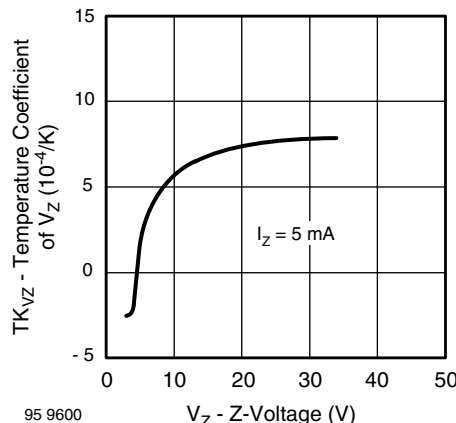

Fig. 3 - Typical Temperature Coefficient of V_Z vs. Z-Voltage

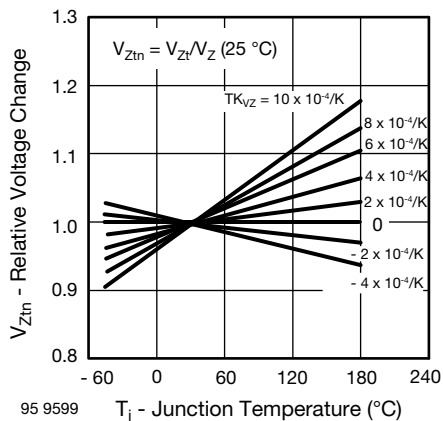

Fig. 2 - Typical Change of Working Voltage vs. Junction Temperature

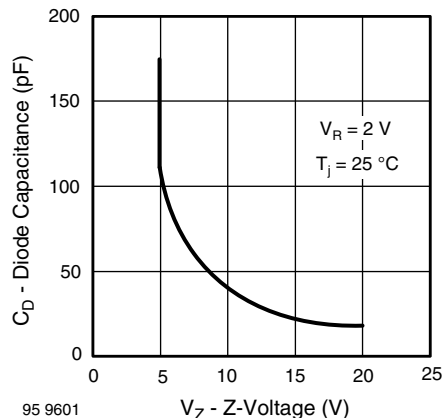

Fig. 4 - Diode Capacitance vs. Z-Voltage

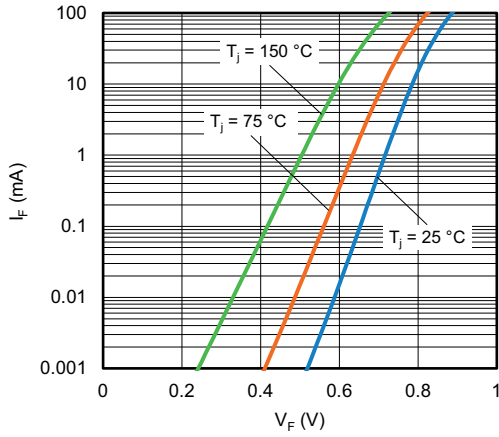

Fig. 5 - Typical Forward Current I_F vs. Forward Voltage V_F

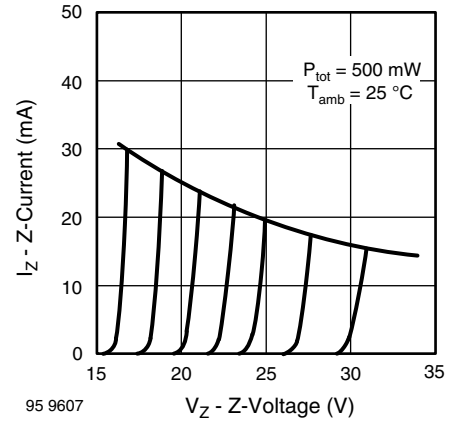

Fig. 7 - Typical Z-Current vs. Z-Voltage

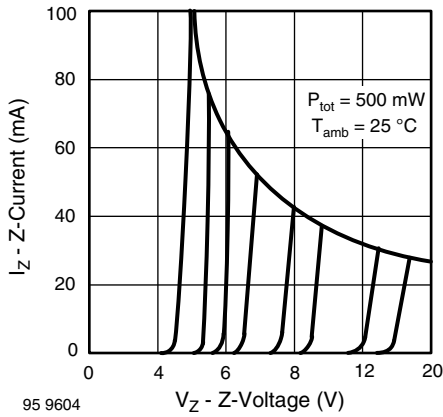

Fig. 6 - Typical Z-Current vs. Z-Voltage

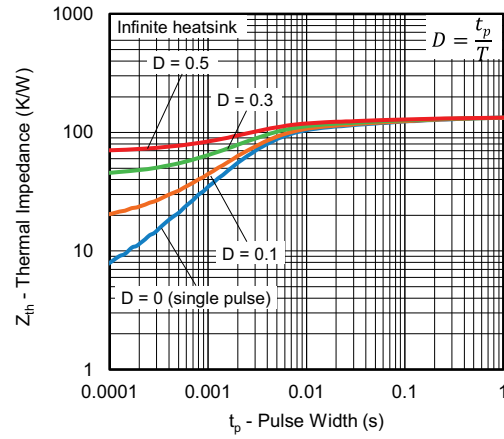

Fig. 8 - Typical Thermal Response



MARKING VOLTAGE GROUP

TLZ MARKING OPTION 1:

MiniMelf (SOD-80)

Marking: type and cathode

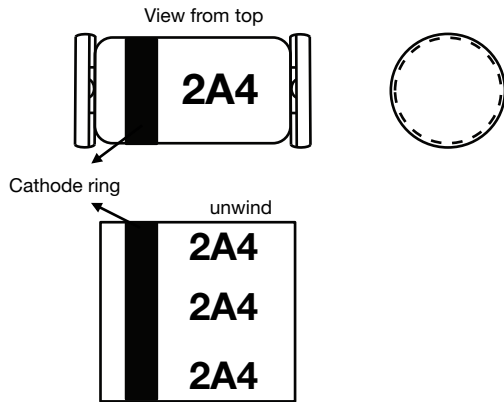

TLZ MARKING OPTION 2:

MiniMelf (SOD-80)

Marking: type and cathode

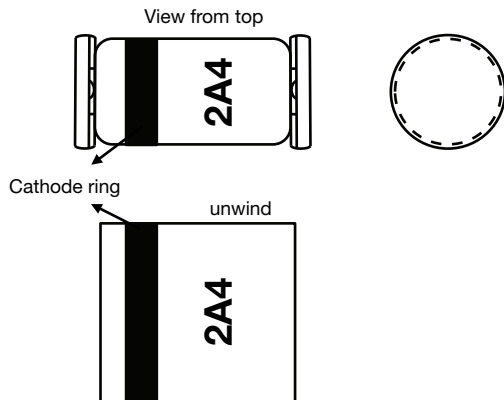



PACKAGE DIMENSIONS in millimeters (inches): **MiniMELF (SOD-80)**

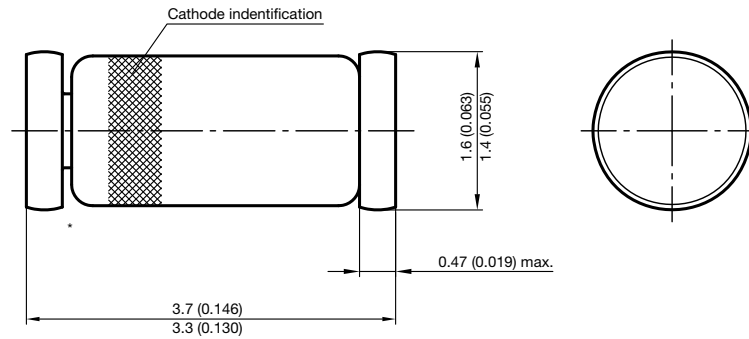

* The gap between plug and glass can be either on cathode or anode side

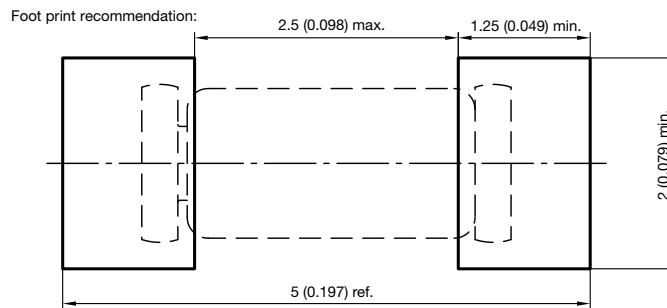

Document no.:6.560-5005.01-4
 Rev. 8 - Date: 07.June.2006
 96 12070



Disclaimer

ALL PRODUCT, PRODUCT SPECIFICATIONS AND DATA ARE SUBJECT TO CHANGE WITHOUT NOTICE TO IMPROVE RELIABILITY, FUNCTION OR DESIGN OR OTHERWISE.

Vishay Intertechnology, Inc., its affiliates, agents, and employees, and all persons acting on its or their behalf (collectively, "Vishay"), disclaim any and all liability for any errors, inaccuracies or incompleteness contained in any datasheet or in any other disclosure relating to any product.

Vishay makes no warranty, representation or guarantee regarding the suitability of the products for any particular purpose or the continuing production of any product. To the maximum extent permitted by applicable law, Vishay disclaims (i) any and all liability arising out of the application or use of any product, (ii) any and all liability, including without limitation special, consequential or incidental damages, and (iii) any and all implied warranties, including warranties of fitness for particular purpose, non-infringement and merchantability.

Statements regarding the suitability of products for certain types of applications are based on Vishay's knowledge of typical requirements that are often placed on Vishay products in generic applications. Such statements are not binding statements about the suitability of products for a particular application. It is the customer's responsibility to validate that a particular product with the properties described in the product specification is suitable for use in a particular application. Parameters provided in datasheets and / or specifications may vary in different applications and performance may vary over time. All operating parameters, including typical parameters, must be validated for each customer application by the customer's technical experts. Product specifications do not expand or otherwise modify Vishay's terms and conditions of purchase, including but not limited to the warranty expressed therein.

Hyperlinks included in this datasheet may direct users to third-party websites. These links are provided as a convenience and for informational purposes only. Inclusion of these hyperlinks does not constitute an endorsement or an approval by Vishay of any of the products, services or opinions of the corporation, organization or individual associated with the third-party website. Vishay disclaims any and all liability and bears no responsibility for the accuracy, legality or content of the third-party website or for that of subsequent links.

Vishay products are not designed for use in life-saving or life-sustaining applications or any application in which the failure of the Vishay product could result in personal injury or death unless specifically qualified in writing by Vishay. Customers using or selling Vishay products not expressly indicated for use in such applications do so at their own risk. Please contact authorized Vishay personnel to obtain written terms and conditions regarding products designed for such applications.

No license, express or implied, by estoppel or otherwise, to any intellectual property rights is granted by this document or by any conduct of Vishay. Product names and markings noted herein may be trademarks of their respective owners.

OUR CERTIFICATE

DiGi provide top-quality products and perfect service for customer worldwide through standardization, technological innovation and continuous improvement. DiGi through third-party certification, we stricly control the quality of products and services. Welcome your RFQ to

Email: Info@DiGi-Electronics.com



Tel: +00 852-30501935

RFQ Email: Info@DiGi-Electronics.com

DiGi is a global authorized distributor of electronic components.