

# VS-VSKH230-08PBF Datasheet

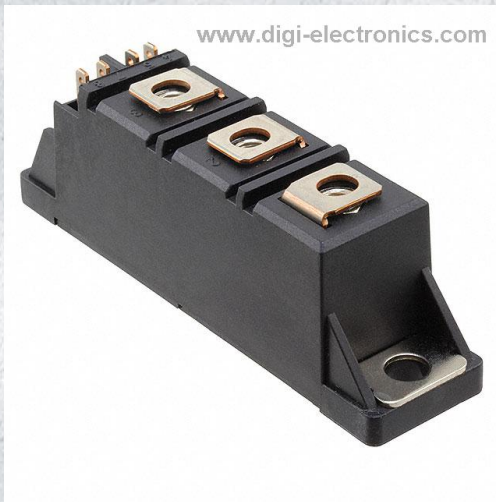

<https://www.DiGi-Electronics.com>

|                              |   |
|------------------------------|---|
| DiGi Electronics Part Number | VS-VSKH230-08PBF-DG   |
| Manufacturer                 | <a href="#">Vishay General Semiconductor - Diodes Division</a>                    |
| Manufacturer Product Number  | VS-VSKH230-08PBF  |
| Description                  | MODULE DIODE 230A MAGN-A-PAK  |
| Detailed Description         | SCR Module 800 V 510 A Series Connection - SCR/Diode Chassis Mount MAGN-A-PAK (3) |

This model VS-VSKH230-08PBF is available at DiGi Electronics.

DiGi Electronics offers a global database of semiconductor and electronic component datasheets.

We welcome your inquiries regarding pricing, lead time, or other product-related questions.

 [Request a Quote](#)

 [Datasheet Search](#)



Tel: +00 852-30501935

RFQ Email: [Info@DiGi-Electronics.com](mailto:Info@DiGi-Electronics.com)

DiGi is a global authorized distributor of electronic components.

## Purchase and inquiry

Manufacturer Product Number:

VS-VSKH230-08PBF

Series:

-

Structure:

Series Connection - SCR/Diode

Voltage - Off State:

800 V

Current - On State (It (RMS)) (Max):

510 A

Current - Gate Trigger (Igt) (Max):

200 mA

Current - Hold (Ih) (Max):

500 mA

Mounting Type:

Chassis Mount

Base Product Number:

VSKH230

Manufacturer:

Vishay General Semiconductor - Diodes Division

Product Status:

Active

Number of SCRs, Diodes:

1 SCR, 1 Diode

Current - On State (It (AV)) (Max):

230 A

Voltage - Gate Trigger (Vgt) (Max):

3 V

Current - Non Rep. Surge 50, 60Hz (I<sub>tsm</sub>):

7500A, 7850A

Operating Temperature:

-40°C ~ 130°C (Tj)

Package / Case:

MAGN-A-PAK (3)

## Environmental & Export classification

RoHS Status:

ROHS3 Compliant

REACH Status:

REACH Unaffected

HTSUS:

8541.30.0080

Moisture Sensitivity Level (MSL):

1 (Unlimited)

ECCN:

EAR99

[www.vishay.com](http://www.vishay.com)

## VS-VSK.230..PbF Series

Vishay Semiconductors

### SCR/SCR and SCR/Diode (MAGN-A-PAK Power Modules), 230 A



MAGN-A-PAK

#### FEATURES

- High voltage
- Electrically isolated base plate
- 3500 V<sub>RMS</sub> isolating voltage
- Industrial standard package
- Simplified mechanical designs, rapid assembly
- High surge capability
- Large creepage distances
- UL approved file E78996 
- Designed and qualified for industrial level
- Material categorization: for definitions of compliance please see [www.vishay.com/doc?99912](http://www.vishay.com/doc?99912)

**RoHS**  
COMPLIANT

#### PRIMARY CHARACTERISTICS

|             |                               |
|-------------|-------------------------------|
| $I_{T(AV)}$ | 230 A                         |
| Type        | Modules - thyristor, standard |
| Package     | MAGN-A-PAK                    |

#### DESCRIPTION

This VSK series of MAGN-A-PAK modules uses high voltage power thyristor/thyristor and thyristor/diode in seven basic configurations. The semiconductors are electrically isolated from the metal base, allowing common heatsinks and compact assemblies to be built. They can be interconnected to form single phase or three phase bridges or as AC-switches when modules are connected in anti-parallel mode. These modules are intended for general purpose applications such as battery chargers, welders, motor drives, UPS, etc.

#### MAJOR RATINGS AND CHARACTERISTICS

| SYMBOL            | CHARACTERISTICS | VALUES      | UNITS              |
|-------------------|-----------------|-------------|--------------------|
| $I_{T(AV)}$       | 85 °C           | 230         | A                  |
| $I_{T(RMS)}$      |                 | 510         |                    |
| $I_{TSM}$         | 50 Hz           | 7500        |                    |
|                   | 60 Hz           | 7850        |                    |
| $I^2t$            | 50 Hz           | 280         | kA <sup>2</sup> s  |
|                   | 60 Hz           | 260         |                    |
| $I^2\sqrt{t}$     |                 | 280         | kA <sup>2</sup> √s |
| $V_{DRM}/V_{RRM}$ |                 | 800 to 2000 | V                  |
| $T_J$             | Range           | -40 to +130 | °C                 |

#### ELECTRICAL SPECIFICATIONS

##### VOLTAGE RATINGS

| TYPE NUMBER | VOLTAGE CODE | $V_{RRM}/V_{DRM}$ , MAXIMUM REPETITIVE PEAK REVERSE AND OFF-STATE BLOCKING VOLTAGE<br>V | $V_{RSM}$ , MAXIMUM NON-REPETITIVE PEAK REVERSE VOLTAGE<br>V | $I_{RRM}/I_{DRM}$ AT 130 °C<br>MAXIMUM<br>mA |
|-------------|--------------|---|--|--|
| VS-VSK.230- | 08           | 800   | 900  | 50   |
|             | 12           | 1200  | 1300   |  |
|             | 16           | 1600  | 1700   |  |
|             | 18           | 1800  | 1900   |  |
|             | 20           | 2000  | 2100   |  |



| ON-STATE CONDUCTION  |               |  |                           |        |                    |
|--|---------------|--|---------------------------|--------|--------------------|
| PARAMETER  | SYMBOL        | TEST CONDITIONS  |                           | VALUES | UNITS              |
| Maximum average on-state current at case temperature           | $I_{T(AV)}$   | 180° conduction, half sine wave  |                           | 230    | A                  |
|  |               |  |                           | 85     | °C                 |
| Maximum RMS on-state current                                   | $I_{T(RMS)}$  | As AC switch   |                           | 510    |                    |
| Maximum peak, one-cycle on-state non-repetitive, surge current | $I_{TSM}$     | t = 10 ms  | No voltage reapplied      | 7500   | A                  |
|  |               | t = 8.3 ms   |                           | 7850   |                    |
|  |               | t = 10 ms  | 100 % $V_{RRM}$ reapplied | 6300   |                    |
|  |               | t = 8.3 ms   |                           | 6600   |                    |
| Maximum $I^2t$ for fusing                                      | $I^2t$        | t = 10 ms  | No voltage reapplied      | 280    | kA <sup>2</sup> s  |
|  |               | t = 8.3 ms   |                           | 256    |                    |
|  |               | t = 10 ms  | 100 % $V_{RRM}$ reapplied | 198    |                    |
|  |               | t = 8.3 ms   |                           | 181    |                    |
| Maximum $I^2\sqrt{t}$ for fusing                               | $I^2\sqrt{t}$ | t = 0.1 ms to 10 ms, no voltage reapplied  |                           | 2800   | kA <sup>2</sup> /s |
| Low level value or threshold voltage                           | $V_{T(TO)1}$  | $(16.7 \% \times \pi \times I_{T(AV)} < I < \pi \times I_{T(AV)})$ , $T_J = T_J$ maximum   |                           | 1.03   | V                  |
| High level value of threshold voltage                          | $V_{T(TO)2}$  | $(I > \pi \times I_{T(AV)})$ , $T_J = T_J$ maximum   |                           | 1.07   |                    |
| Low level value on-state slope resistance                      | $r_{t1}$      | $(16.7 \% \times \pi \times I_{T(AV)} < I < \pi \times I_{T(AV)})$ , $T_J = T_J$ maximum   |                           | 0.77   | mΩ                 |
| High level value on-state slope resistance                     | $r_{t2}$      | $(I > \pi \times I_{T(AV)})$ , $T_J = T_J$ maximum   |                           | 0.73   |                    |
| Maximum on-state voltage drop                                  | $V_{TM}$      | $I_{TM} = \pi \times I_{T(AV)}$ , $T_J = T_J$ maximum, 180° conduction, average power = $V_{T(TO)} \times I_{T(AV)} + r_f \times (I_{T(RMS)})^2$ |                           | 1.59   | V                  |
| Maximum holding current  | $I_H$         | Anode supply = 12 V, initial $I_T = 30$ A, $T_J = 25$ °C   |                           | 500    |                    |
| Maximum latching current                                       | $I_L$         | Anode supply = 12 V, resistive load = 1 Ω, gate pulse: 10 V, 100 μs, $T_J = 25$ °C   |                           | 1000   | mA                 |

| SWITCHING             |        |  |  |           |       |
|-----------------------|--------|--|--|-----------|-------|
| PARAMETER             | SYMBOL | TEST CONDITIONS  |  | VALUES    | UNITS |
| Typical delay time    | $t_d$  | $T_J = 25$ °C, gate current = 1 A $dI_g/dt = 1$ A/μs, $V_d = 0.67 \% V_{DRM}$                              |  | 1.0       | μs    |
| Typical rise time     | $t_r$  |  |  | 2.0       |       |
| Typical turn-off time | $t_q$  | $I_{TM} = 300$ A; $dI/dt = 15$ A/μs; $T_J = T_J$ maximum; $V_R = 50$ V; $dV/dt = 20$ V/μs; gate 0 V, 100 Ω |  | 50 to 150 |       |

| BLOCKING   |                       |   |  |        |       |
|--|-----------------------|---|--|--------|-------|
| PARAMETER  | SYMBOL                | TEST CONDITIONS   |  | VALUES | UNITS |
| Maximum peak reverse and off-state leakage current | $I_{RRM}$ , $I_{DRM}$ | $T_J = T_J$ maximum                                       |  | 50     | mA    |
| RMS insulation voltage                             | $V_{INS}$             | 50 Hz, circuit to base, all terminals shorted, 25 °C, 1 s |  | 3000   | V     |
| Critical rate of rise of off-state voltage         | $dV/dt$               | $T_J = T_J$ maximum, exponential to 67 % rated $V_{DRM}$  |  | 1000   | V/μs  |

| TRIGGERING                                  |             |  |  |        |       |
|---|-------------|--|--|--------|-------|
| PARAMETER                                   | SYMBOL      | TEST CONDITIONS  |  | VALUES | UNITS |
| Maximum peak gate power                     | $P_{GM}$    | $t_p \leq 5$ ms, $T_J = T_J$ maximum                           |  | 10.0   | W     |
| Maximum average gate power                  | $P_{G(AV)}$ | f = 50 Hz, $T_J = T_J$ maximum                                 |  | 2.0    |       |
| Maximum peak gate current                   | + $I_{GM}$  | $t_p \leq 5$ ms, $T_J = T_J$ maximum                           |  | 3.0    | A     |
| Maximum peak negative gate voltage          | - $V_{GT}$  | $t_p \leq 5$ ms, $T_J = T_J$ maximum                           |  | 5.0    |       |
| Maximum required DC gate voltage to trigger | $V_{GT}$    | $T_J = -40$ °C   | Anode supply = 12 V, resistive load; $R_a = 1$ Ω | 4.0    | V     |
|   |             | $T_J = 25$ °C  |  | 3.0    |       |
|   |             | $T_J = T_J$ maximum  |  | 2.0    |       |
| Maximum required DC gate current to trigger | $I_{GT}$    | $T_J = -40$ °C   | Anode supply = 12 V, resistive load; $R_a = 1$ Ω | 350    | mA    |
|   |             | $T_J = 25$ °C  |  | 200    |       |
|   |             | $T_J = T_J$ maximum  |  | 100    |       |
| Maximum gate voltage that will not trigger  | $V_{GD}$    | $T_J = T_J$ maximum, rated $V_{DRM}$ applied                   |  | 0.25   | V     |
| Maximum gate current that will not trigger  | $I_{GD}$    | $T_J = T_J$ maximum, rated $V_{DRM}$ applied                   |  | 10.0   | mA    |
| Maximum rate of rise of turned-on current   | $dI/dt$     | $T_J = T_J$ maximum, $I_{TM} = 400$ A, rated $V_{DRM}$ applied |  | 500    | A/μs  |



| THERMAL AND MECHANICAL SPECIFICATIONS                     |  |  |             |       |
|---|--|--|-------------|-------|
| PARAMETER   | SYMBOL   | TEST CONDITIONS  | VALUES      | UNITS |
| Junction operating temperature range                      | $T_J$  |  | -40 to +130 | °C    |
| Storage temperature range                                 | $T_{Stg}$                                      |  | -40 to +150 |       |
| Maximum thermal resistance, junction to case per junction | $R_{thJC}$                                     | DC operation   | 0.125       | K/W   |
| Typical thermal resistance, case to heatsink per module   | $R_{thCS}$                                     | Mounting surface flat, smooth, and greased   | 0.02        |       |
| Mounting torque $\pm 10\%$                                | MAGN-A-PAK to heatsink<br>busbar to MAGN-A-PAK | A mounting compound is recommended and the torque should be rechecked after a period of about 3 h to allow for the spread of the compound. | 4 to 6      | Nm    |
| Approximate weight  |  |  | 500         | g     |
|   |  |  | 17.8        | oz.   |
| Case style  |  |  | MAGN-A-PAK  |       |

| $\Delta R$ CONDUCTION PER JUNCTION |  |       |       |       |       |   |       |       |       |       |       |
|------------------------------------|--|-------|-------|-------|-------|---|-------|-------|-------|-------|-------|
| DEVICES                            | SINUSOIDAL CONDUCTION AT $T_J$ MAXIMUM |       |       |       |       | RECTANGULAR CONDUCTION AT $T_J$ MAXIMUM |       |       |       |       | UNITS |
|                                    | 180°                                   | 120°  | 90°   | 60°   | 30°   | 180°                                    | 120°  | 90°   | 60°   | 30°   |       |
| VSK.230-                           | 0.009                                  | 0.010 | 0.010 | 0.020 | 0.032 | 0.007                                   | 0.011 | 0.015 | 0.020 | 0.033 | K/W   |

**Note**

- Table shows the increment of thermal resistance  $R_{thJC}$  when devices operate at different conduction angles than DC

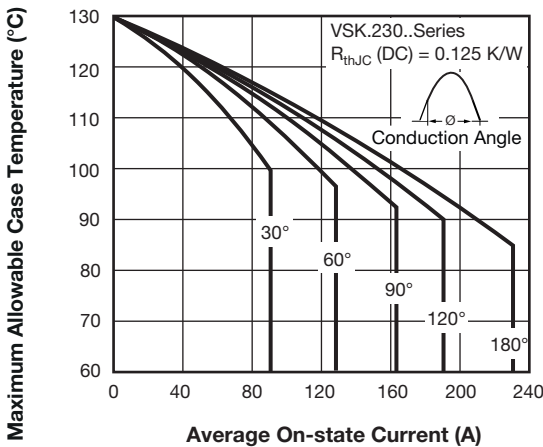

Fig. 1 - Current Ratings Characteristics

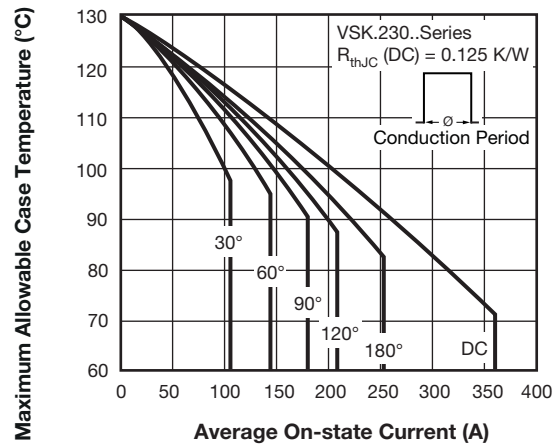

Fig. 2 - Current Ratings Characteristics



# VS-VSK.230..PbF Series

Vishay Semiconductors

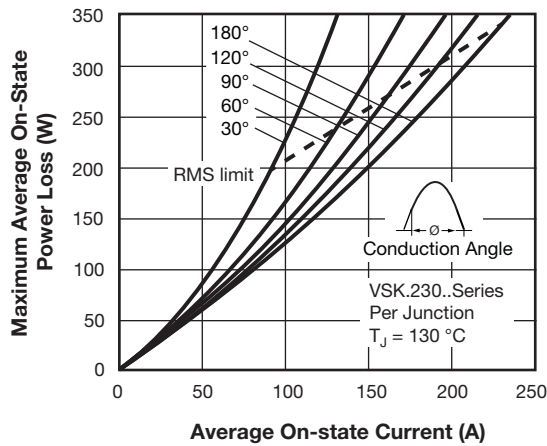

Fig. 3 - On-State Power Loss Characteristics

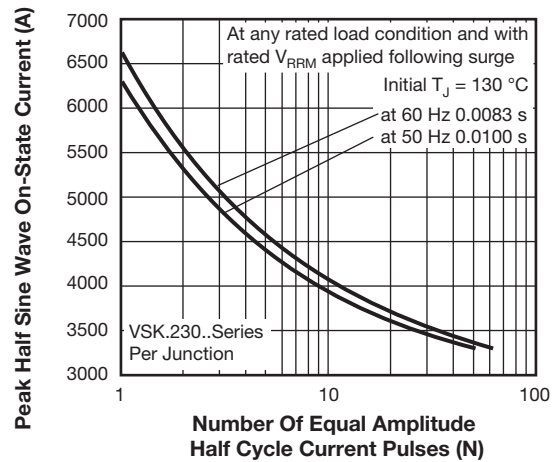

Fig. 5 - Maximum Non-Repetitive Surge Current

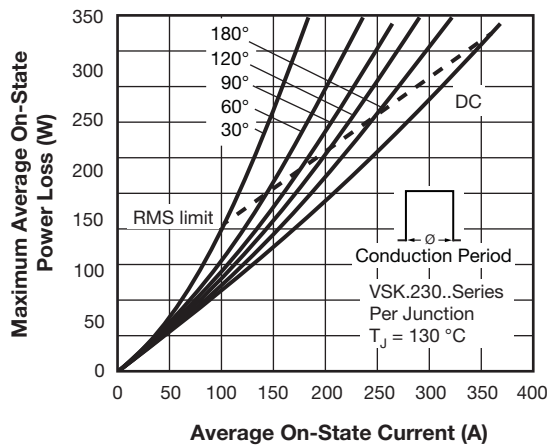

Fig. 4 - On-State Power Loss Characteristics

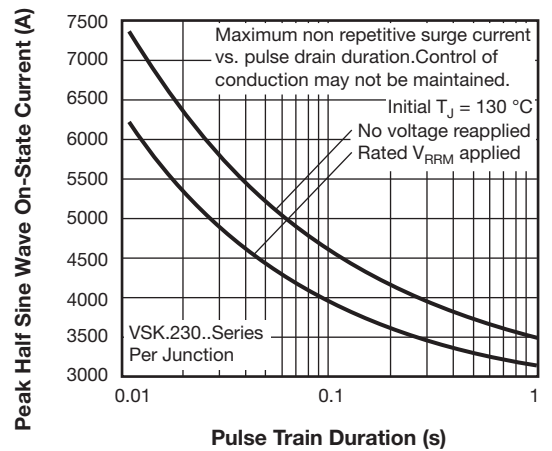

Fig. 6 - Maximum Non-Repetitive Surge Current

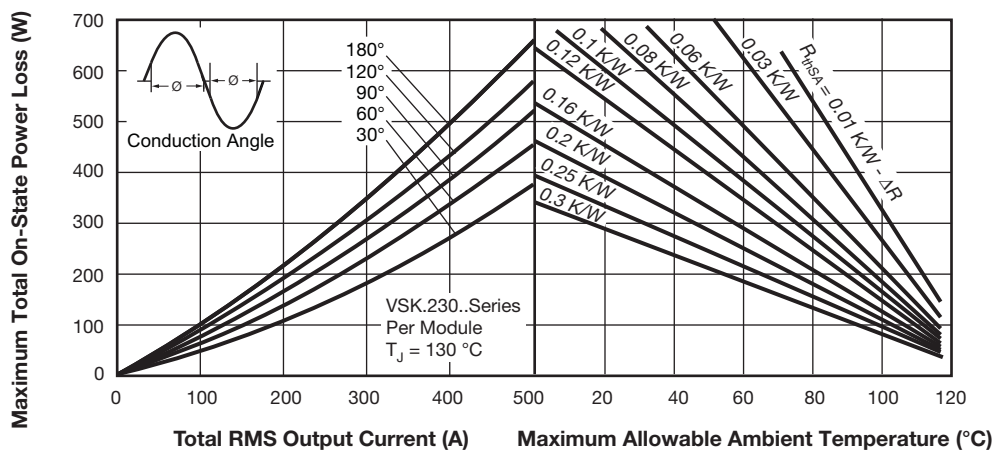

Fig. 7 - On-State Power Loss Characteristics

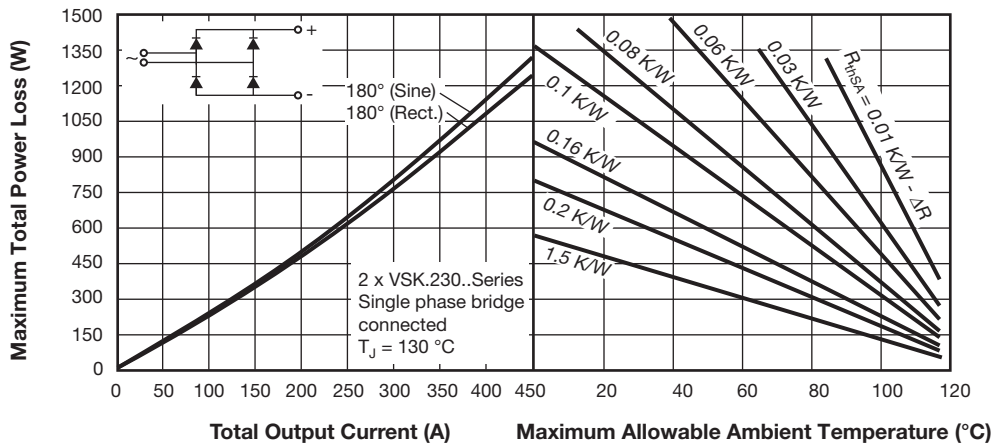

Fig. 8 - On-State Power Loss Characteristics

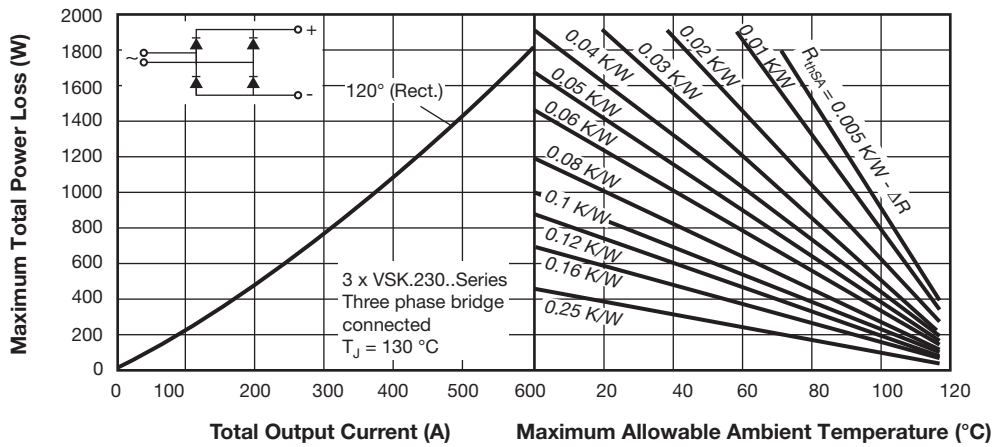

Fig. 9 - On-State Power Loss Characteristics

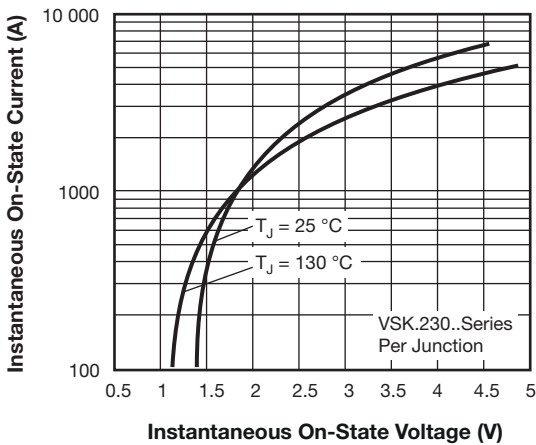

Fig. 10 - On-State Voltage Drop Characteristics

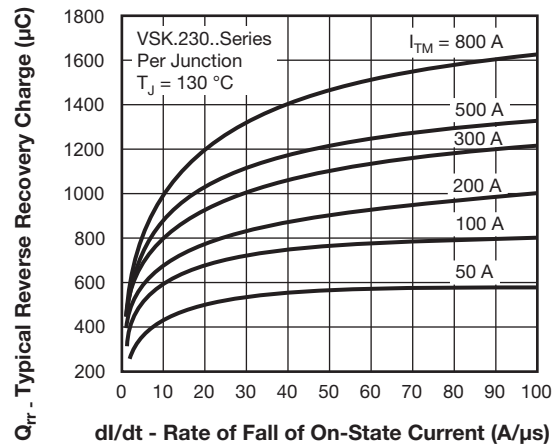

Fig. 11 - Reverse Recovery Charge Characteristics

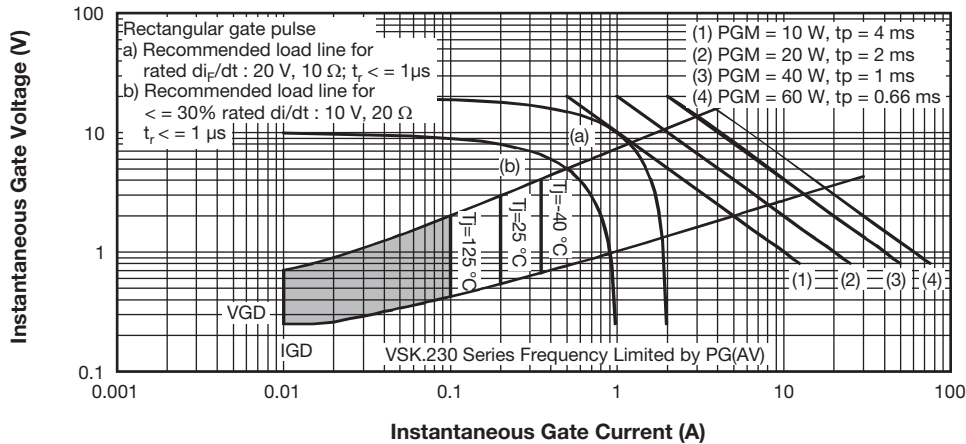

Fig. 12 - Gate Characteristics

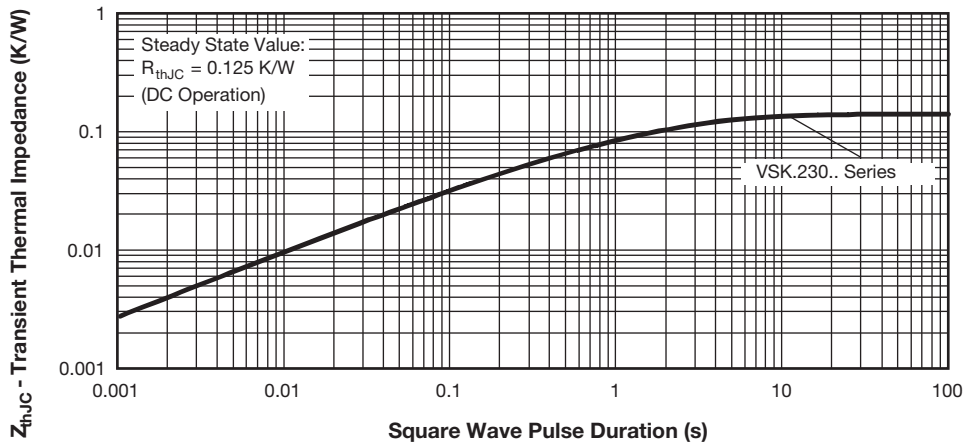

Fig. 13 - Thermal Impedance  $Z_{thJC}$  Characteristics

**ORDERING INFORMATION TABLE**

|             |              |           |            |          |           |            |
|-------------|--------------|-----------|------------|----------|-----------|------------|
| Device code | <b>VS-VS</b> | <b>KT</b> | <b>230</b> | <b>-</b> | <b>20</b> | <b>PbF</b> |
|             | ①            | ②         | ③          |          | ④         | ⑤          |

- 1** - Vishay Semiconductors product
- 2** - Circuit configuration (see dimensions - link at the end of datasheet)
- 3** - Current rating
- 4** - Voltage code x 100 =  $V_{RRM}$  (see Voltage Ratings table)
- 5** - • None = standard production  
• PbF = lead (Pb)-free

**Note**

- To order the optional hardware go to [www.vishay.com/doc?95172](http://www.vishay.com/doc?95172)



www.vishay.com

# VS-VSK.230..PbF Series

Vishay Semiconductors

| CIRCUIT CONFIGURATION                       |                            |   |
|---|----------------------------|---|
| CIRCUIT DESCRIPTION                         | CIRCUIT CONFIGURATION CODE | CIRCUIT DRAWING   |
| Two SCRs doubler circuit                    | KT                         | <p>VSKT...</p> <p>Available 800 V: contact factory for different requirements</p> |
| SCR/diode doubler circuit, positive control | KH                         | <p>VSKH...</p> <p>Available 800 V: contact factory for different requirements</p> |
| SCR/diode doubler circuit, negative control | KL                         | <p>VSKL...</p> <p>Available 800 V: contact factory for different requirements</p> |
| Two SCRs common cathodes                    | KK                         | <p>VSKK...</p> <p>Available 800 V: contact factory for different requirements</p> |

| LINKS TO RELATED DOCUMENTS |  |
|----------------------------|--|
| Dimensions                 | <a href="http://www.vishay.com/doc?95086">www.vishay.com/doc?95086</a> |



# Outline Dimensions

Vishay Semiconductors

## MAGN-A-PAK

**DIMENSIONS** in millimeters (inches)

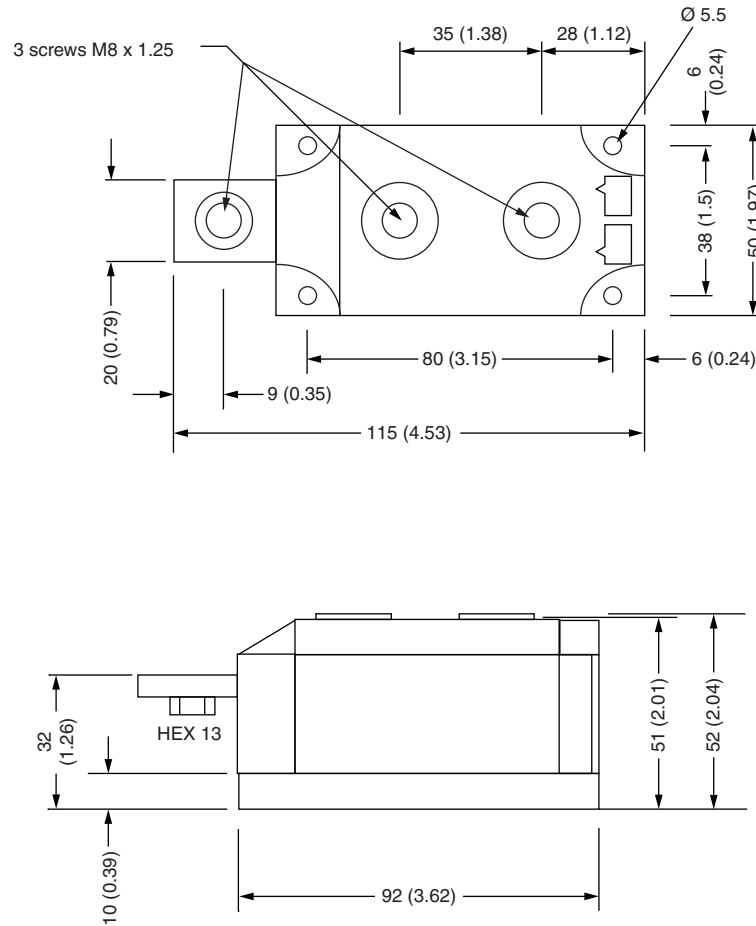

### Notes

- Dimensions are nominal
- Full engineering drawings are available on request
- UL identification number for gate and cathode wire: UL 1385
- UL identification number for package: UL 94 V-0



## Disclaimer

ALL PRODUCT, PRODUCT SPECIFICATIONS AND DATA ARE SUBJECT TO CHANGE WITHOUT NOTICE TO IMPROVE RELIABILITY, FUNCTION OR DESIGN OR OTHERWISE.

Vishay Intertechnology, Inc., its affiliates, agents, and employees, and all persons acting on its or their behalf (collectively, "Vishay"), disclaim any and all liability for any errors, inaccuracies or incompleteness contained in any datasheet or in any other disclosure relating to any product.

Vishay makes no warranty, representation or guarantee regarding the suitability of the products for any particular purpose or the continuing production of any product. To the maximum extent permitted by applicable law, Vishay disclaims (i) any and all liability arising out of the application or use of any product, (ii) any and all liability, including without limitation special, consequential or incidental damages, and (iii) any and all implied warranties, including warranties of fitness for particular purpose, non-infringement and merchantability.

Statements regarding the suitability of products for certain types of applications are based on Vishay's knowledge of typical requirements that are often placed on Vishay products in generic applications. Such statements are not binding statements about the suitability of products for a particular application. It is the customer's responsibility to validate that a particular product with the properties described in the product specification is suitable for use in a particular application. Parameters provided in datasheets and / or specifications may vary in different applications and performance may vary over time. All operating parameters, including typical parameters, must be validated for each customer application by the customer's technical experts. Product specifications do not expand or otherwise modify Vishay's terms and conditions of purchase, including but not limited to the warranty expressed therein.

Hyperlinks included in this datasheet may direct users to third-party websites. These links are provided as a convenience and for informational purposes only. Inclusion of these hyperlinks does not constitute an endorsement or an approval by Vishay of any of the products, services or opinions of the corporation, organization or individual associated with the third-party website. Vishay disclaims any and all liability and bears no responsibility for the accuracy, legality or content of the third-party website or for that of subsequent links.

Vishay products are not designed for use in life-saving or life-sustaining applications or any application in which the failure of the Vishay product could result in personal injury or death unless specifically qualified in writing by Vishay. Customers using or selling Vishay products not expressly indicated for use in such applications do so at their own risk. Please contact authorized Vishay personnel to obtain written terms and conditions regarding products designed for such applications.

No license, express or implied, by estoppel or otherwise, to any intellectual property rights is granted by this document or by any conduct of Vishay. Product names and markings noted herein may be trademarks of their respective owners.

## OUR CERTIFICATE

DiGi provide top-quality products and perfect service for customer worldwide through standardization, technological innovation and continuous improvement. DiGi through third-party certification, we stricly control the quality of products and services. Welcome your RFQ to

Email: [Info@DiGi-Electronics.com](mailto:Info@DiGi-Electronics.com)



Tel: +00 852-30501935

RFQ Email: [Info@DiGi-Electronics.com](mailto:Info@DiGi-Electronics.com)

DiGi is a global authorized distributor of electronic components.