

VS-VSKL250-16PBF Datasheet

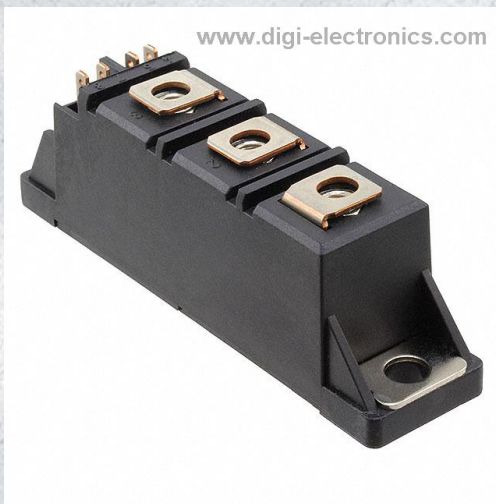

<https://www.DiGi-Electronics.com>

DiGi Electronics Part Number	VS-VSKL250-16PBF-DG
Manufacturer	Vishay General Semiconductor - Diodes Division
Manufacturer Product Number	VS-VSKL250-16PBF
Description	MODULE DIODE 250A MAGN-A-PAK
Detailed Description	SCR Module 400 V 555 A Series Connection - SCR/Diode Chassis Mount MAGN-A-PAK

This model VS-VSKL250-16PBF is available at DiGi Electronics.

DiGi Electronics offers a global database of semiconductor and electronic component datasheets.

We welcome your inquiries regarding pricing, lead time, or other product-related questions.

 [Request a Quote](#)

 [Datasheet Search](#)



Tel: +00 852-30501935

RFQ Email: Info@DiGi-Electronics.com

DiGi is a global authorized distributor of electronic components.

Purchase and inquiry

Manufacturer Product Number:

VS-VSKL250-16PBF

Series:

-

Structure:

Series Connection - SCR/Diode

Voltage - Off State:

400 V

Current - On State (It (RMS)) (Max):

555 A

Current - Gate Trigger (Igt) (Max):

200 mA

Current - Hold (Ih) (Max):

500 mA

Mounting Type:

Chassis Mount

Base Product Number:

VSKL250

Manufacturer:

Vishay General Semiconductor - Diodes Division

Product Status:

Active

Number of SCRs, Diodes:

1 SCR, 1 Diode

Current - On State (It (AV)) (Max):

250 A

Voltage - Gate Trigger (Vgt) (Max):

3 V

Current - Non Rep. Surge 50, 60Hz (I_{tsm}):

8500A, 8900A

Operating Temperature:

-40°C ~ 130°C (Tj)

Package / Case:

MAGN-A-PAK

Environmental & Export classification

RoHS Status:

ROHS3 Compliant

REACH Status:

REACH Unaffected

HTSUS:

8541.30.0080

Moisture Sensitivity Level (MSL):

1 (Unlimited)

ECCN:

EAR99



www.vishay.com

VS-VSK.170PbF, VS-VSK.250PbF

Vishay Semiconductors

SCR/SCR and SCR/Diode (MAGN-A-PAK Power Modules), 170 A, 250 A



MAGN-A-PAK

FEATURES

- High voltage
- Electrically isolated base plate
- 3500 V_{RMS} isolating voltage
- Industrial standard package
- Simplified mechanical designs, rapid assembly
- High surge capability
- Large creepage distances
- UL approved file E78996 
- Designed and qualified for industrial level
- Material categorization: for definitions of compliance please see www.vishay.com/doc?99912



RoHS
 COMPLIANT

PRIMARY CHARACTERISTICS	
I _{T(AV)}	170 A, 250 A
Type	Modules - thyristor, standard
Package	MAGN-A-PAK

DESCRIPTION

This VSK series of MAGN-A-PAK modules uses high voltage power thyristor/thyristor and thyristor/diode in seven basic configurations. The semiconductors are electrically isolated from the metal base, allowing common heatsinks and compact assemblies to be built. They can be interconnected to form single phase or three phase bridges or as AC-switches when modules are connected in anti-parallel mode. These modules are intended for general purpose applications such as battery chargers, welders, motor drives, UPS, etc.

MAJOR RATINGS AND CHARACTERISTICS				
SYMBOL	CHARACTERISTICS	VSK.170..	VSK.250..	UNITS
I _{T(AV)}	85 °C	170	250	A
I _{T(RMS)}		377	555	
I _{TSM}	50 Hz	5100	8500	
	60 Hz	5350	8900	
I ² t	50 Hz	131	361	kA ² s
	60 Hz	119	330	
I ² √t		1310	3610	kA ² √s
V _{DRM} /V _{RRM}		400 to 1600	400 to 2000	V
T _J	Range	-40 to +130		°C



www.vishay.com

VS-VSK.170PbF, VS-VSK.250PbF

Vishay Semiconductors

ELECTRICAL SPECIFICATIONS

VOLTAGE RATINGS				
TYPE NUMBER	VOLTAGE CODE	V_{RRM}/V_{DRM} , MAXIMUM REPETITIVE PEAK REVERSE AND OFF-STATE BLOCKING VOLTAGE V	V_{RSM} , MAXIMUM NON-REPETITIVE PEAK REVERSE VOLTAGE V	I_{RRM}/I_{DRM} AT 130 °C MAXIMUM mA
VS-VSK.170-	04	400	500	50
	08	800	900	
	10	1000	1100	
	12	1200	1300	
	14	1400	1500	
	16	1600	1700	
VS-VSK.250-	04	400	500	50
	08	800	900	
	10	1000	1100	
	12	1200	1300	
	14	1400	1500	
	16	1600	1700	
	18	1800	1900	60
	20	2000	2100	

ON-STATE CONDUCTION							
PARAMETER	SYMBOL	TEST CONDITIONS		VSK.170	VSK.250	UNITS	
Maximum average on-state current at case temperature	$I_{T(AV)}$	180° conduction, half sine wave		170	250	A	
				85	85	°C	
Maximum RMS on-state current	$I_{T(RMS)}$	As AC switch		377	555	A	
Maximum peak, one-cycle on-state non-repetitive, surge current	I_{TSM}	t = 10 ms	No voltage reapplied	Sinusoidal half wave, initial $T_J = T_J$ maximum	5100		8500
		t = 8.3 ms			5350		8900
		t = 10 ms	100 % V_{RRM} reapplied		4300		7150
		t = 8.3 ms			4500	7500	
Maximum I^2t for fusing	I^2t	t = 10 ms	No voltage reapplied		131	361	
		t = 8.3 ms			119	330	
		t = 10 ms	100 % V_{RRM} reapplied		92.5	255	
		t = 8.3 ms			84.4	233	
Maximum $I^2\sqrt{t}$ for fusing	$I^2\sqrt{t}$	t = 0.1 ms to 10 ms, no voltage reapplied		1310	3610	$kA^2\sqrt{s}$	
Low level value or threshold voltage	$V_{T(TO)1}$	(16.7 % $\times \pi \times I_{T(AV)} < I < \pi \times I_{T(AV)}$, $T_J = T_J$ maximum)		0.89	0.97	V	
High level value of threshold voltage	$V_{T(TO)2}$	(I > $\pi \times I_{T(AV)}$, $T_J = T_J$ maximum)		1.12	1.00		
Low level value on-state slope resistance	r_{t1}	(16.7 % $\times \pi \times I_{T(AV)} < I < \pi \times I_{T(AV)}$, $T_J = T_J$ maximum)		1.34	0.60	mΩ	
High level value on-state slope resistance	r_{t2}	(I > $\pi \times I_{T(AV)}$, $T_J = T_J$ maximum)		0.96	0.57		
Maximum on-state voltage drop	V_{TM}	$I_{TM} = \pi \times I_{T(AV)}$, $T_J = T_J$ maximum, 180° conduction, average power = $V_{T(TO)} \times I_{T(AV)} + r_f \times (I_{T(RMS)})^2$		1.60	1.44	V	
Maximum holding current	I_H	Anode supply = 12 V, initial $I_T = 30$ A, $T_J = 25$ °C		500	500	mA	
Maximum latching current	I_L	Anode supply = 12 V, resistive load = 1 Ω, gate pulse: 10 V, 100 μs, $T_J = 25$ °C		1000	1000		



www.vishay.com

VS-VSK.170PbF, VS-VSK.250PbF

Vishay Semiconductors

SWITCHING					
PARAMETER	SYMBOL	TEST CONDITIONS	VSK.170	VSK.250	UNITS
Typical delay time	t_d	$T_J = 25\text{ }^\circ\text{C}$, gate current = 1 A $dI_g/dt = 1\text{ A}/\mu\text{s}$ $V_d = 0.67\% V_{DRM}$	1.0		μs
Typical rise time	t_r		2.0		
Typical turn-off time	t_q	$I_{TM} = 300\text{ A}$; $dI/dt = 15\text{ A}/\mu\text{s}$; $T_J = T_J$ maximum; $V_R = 50\text{ V}$; $dV/dt = 20\text{ V}/\mu\text{s}$; gate 0 V, 100 Ω	50 to 150		

BLOCKING					
PARAMETER	SYMBOL	TEST CONDITIONS	VSK.170	VSK.250	UNITS
Maximum peak reverse and off-state leakage current	I_{RRM} , I_{DRM}	$T_J = T_J$ maximum	50	60	mA
RMS insulation voltage	V_{INS}	50 Hz, circuit to base, all terminals shorted, 25 $^\circ\text{C}$, 1 s	3000		V
Critical rate of rise of off-state voltage	dV/dt	$T_J = T_J$ maximum, exponential to 67 % rated V_{DRM}	1000		V/ μs

TRIGGERING					
PARAMETER	SYMBOL	TEST CONDITIONS	VSK.170	VSK.250	UNITS
Maximum peak gate power	P_{GM}	$t_p \leq 5\text{ ms}$, $T_J = T_J$ maximum	10.0		W
Maximum average gate power	$P_{G(AV)}$	$f = 50\text{ Hz}$, $T_J = T_J$ maximum	2.0		
Maximum peak gate current	+ I_{GM}	$t_p \leq 5\text{ ms}$, $T_J = T_J$ maximum	3.0		A
Maximum peak negative gate voltage	- V_{GT}	$t_p \leq 5\text{ ms}$, $T_J = T_J$ maximum	5.0		V
Maximum required DC gate voltage to trigger	V_{GT}	$T_J = -40\text{ }^\circ\text{C}$	4.0		
		$T_J = 25\text{ }^\circ\text{C}$	3.0		
		$T_J = T_J$ maximum	2.0		
Maximum required DC gate current to trigger	I_{GT}	$T_J = -40\text{ }^\circ\text{C}$	350		
		$T_J = 25\text{ }^\circ\text{C}$	200		
		$T_J = T_J$ maximum	100		
Maximum gate voltage that will not trigger	V_{GD}	$T_J = T_J$ maximum, rated V_{DRM} applied	0.25		V
Maximum gate current that will not trigger	I_{GD}	$T_J = T_J$ maximum, rated V_{DRM} applied	10.0		mA
Maximum rate of rise of turned-on current	dI/dt	$T_J = T_J$ maximum, $I_{TM} = 400\text{ A}$, rated V_{DRM} applied	500		A/ μs

THERMAL AND MECHANICAL SPECIFICATIONS					
PARAMETER	SYMBOL	TEST CONDITIONS	VSK.170	VSK.250	UNITS
Junction operating and storage temperature range	T_J , T_{Stg}		-40 to +130		$^\circ\text{C}$
Maximum thermal resistance, junction to case per junction	R_{thJC}	DC operation	0.17	0.125	K/W
Typical thermal resistance, case to heatsink per module	R_{thCS}	Mounting surface flat, smooth and greased	0.02	0.02	
Mounting torque $\pm 10\%$	MAGN-A-PAK to heatsink busbar to MAGN-A-PAK	A mounting compound is recommended and the torque should be rechecked after a period of about 3 hours to allow for the spread of the compound.	4 to 6		Nm
Approximate weight			500	g	
Case style			17.8		oz.
			MAGN-A-PAK		



www.vishay.com

VS-VSK.170PbF, VS-VSK.250PbF

Vishay Semiconductors

ΔR CONDUCTION PER JUNCTION											
DEVICES	SINUSOIDAL CONDUCTION AT T _J MAXIMUM					RECTANGULAR CONDUCTION AT T _J MAXIMUM					UNITS
	180°	120°	90°	60°	30°	180°	120°	90°	60°	30°	
VSK.170-	0.009	0.010	0.010	0.020	0.032	0.007	0.011	0.015	0.020	0.033	K/W
VSK.250-	0.009	0.010	0.014	0.020	0.032	0.007	0.011	0.015	0.020	0.033	

Note

- Table shows the increment of thermal resistance R_{thJC} when devices operate at different conduction angles than DC

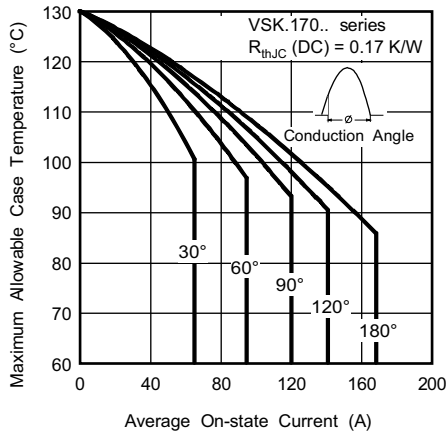

Fig. 1 - Current Ratings Characteristics

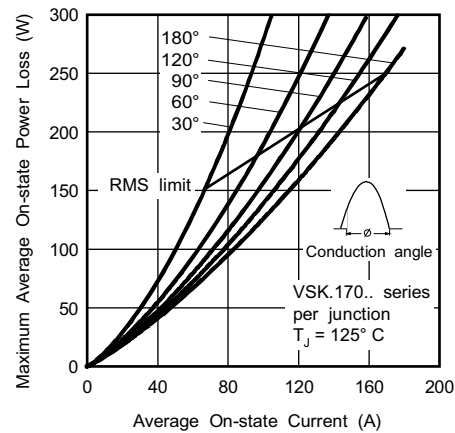

Fig. 3 - On-State Power Loss Characteristics

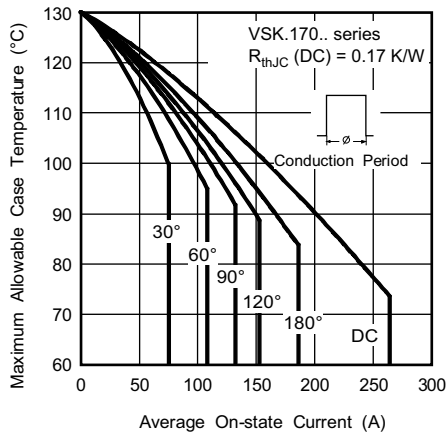

Fig. 2 - Current Ratings Characteristics

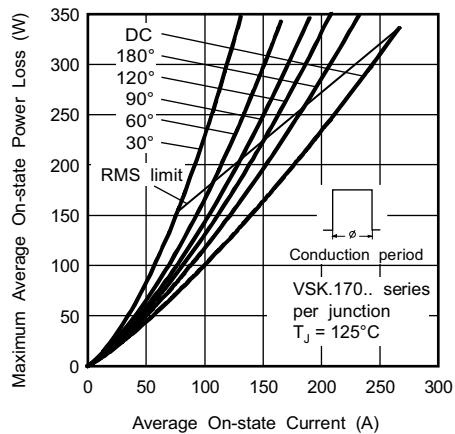

Fig. 4 - On-State Power Loss Characteristics



www.vishay.com

VS-VSK.170PbF, VS-VSK.250PbF

Vishay Semiconductors

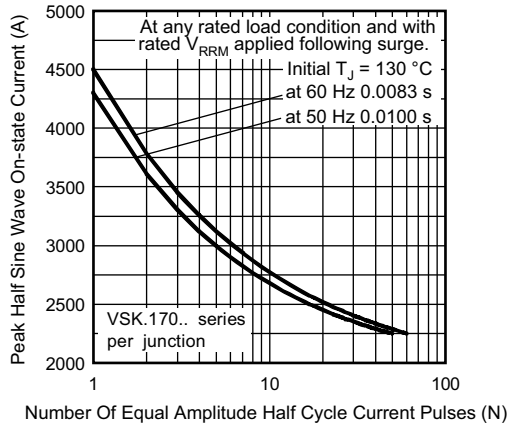

Fig. 5 - Maximum Non-Repetitive Surge Current

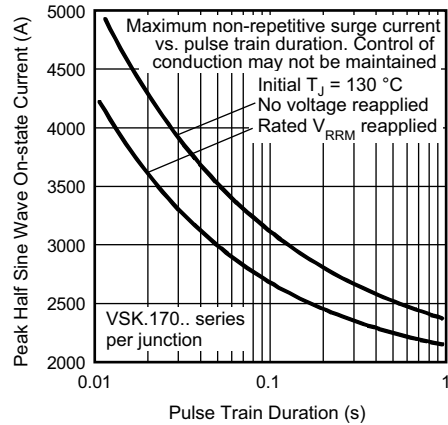

Fig. 6 - Maximum Non-Repetitive Surge Current

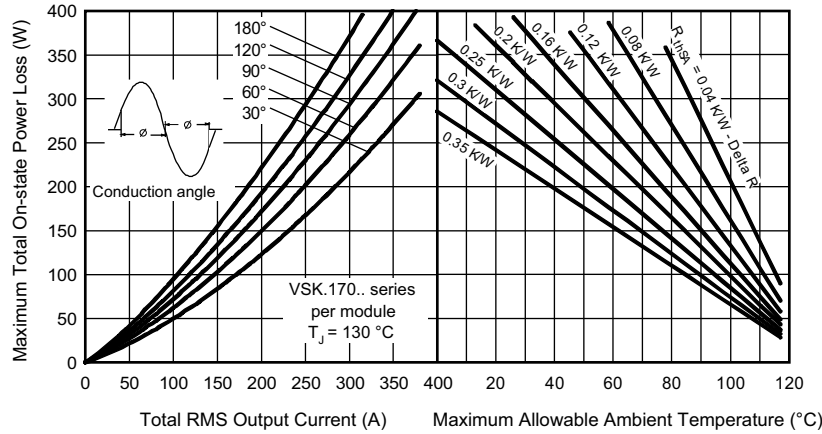

Fig. 7 - On-State Power Loss Characteristics

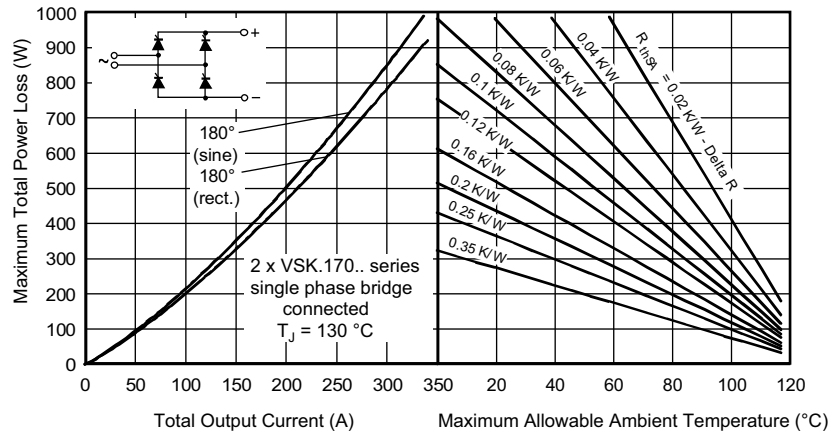

Fig. 8 - On-State Power Loss Characteristics



www.vishay.com

VS-VSK.170PbF, VS-VSK.250PbF

Vishay Semiconductors

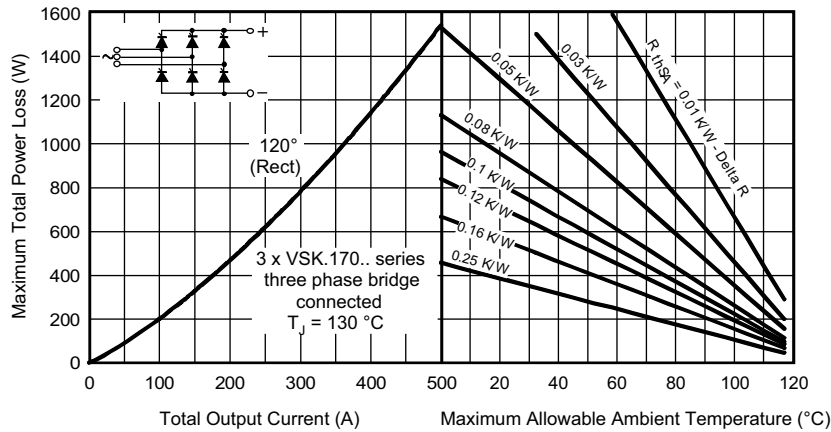

Fig. 9 - On-State Power Loss Characteristics

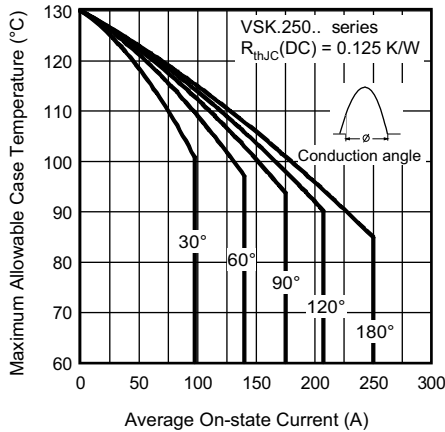

Fig. 10 - Current Ratings Characteristics

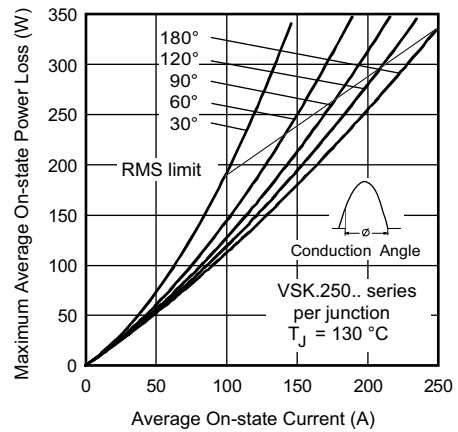

Fig. 12 - On-State Power Loss Characteristics

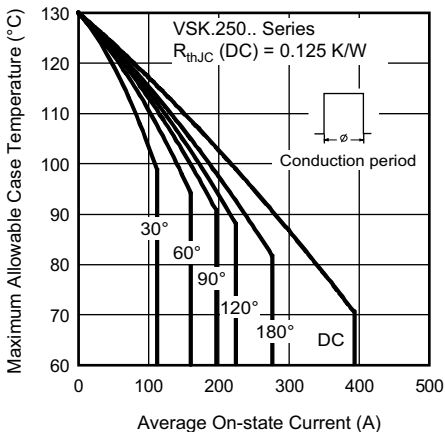

Fig. 11 - Current Ratings Characteristics

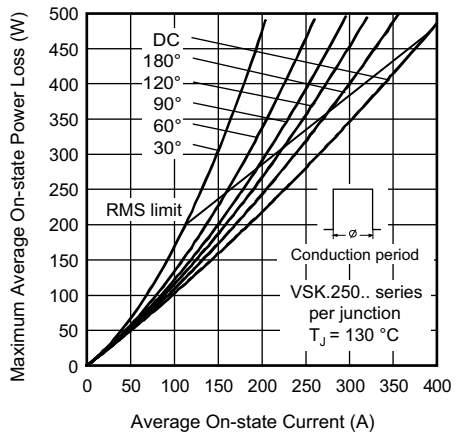

Fig. 13 - On-State Power Loss Characteristics



www.vishay.com

VS-VSK.170PbF, VS-VSK.250PbF

Vishay Semiconductors

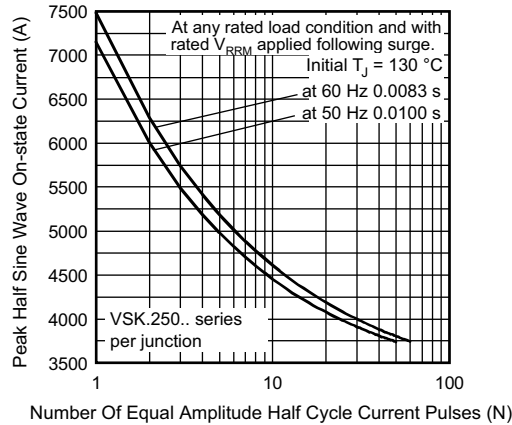

Fig. 14 - Maximum Non-Repetitive Surge Current

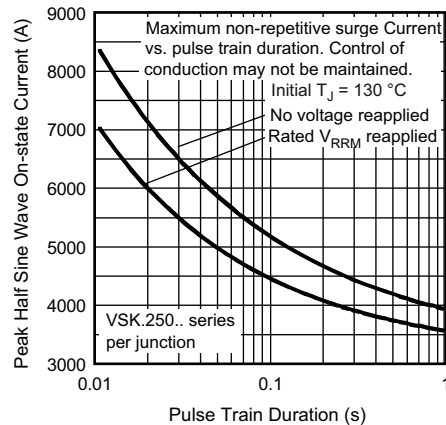

Fig. 15 - Maximum Non-Repetitive Surge Current

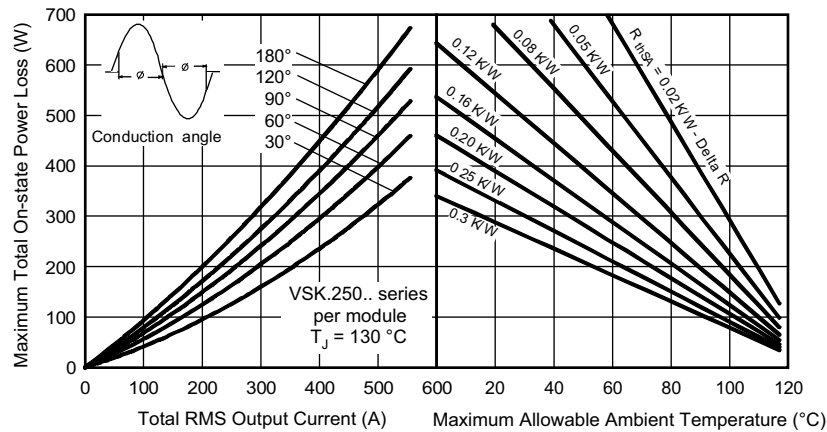

Fig. 16 - On-State Power Loss Characteristics

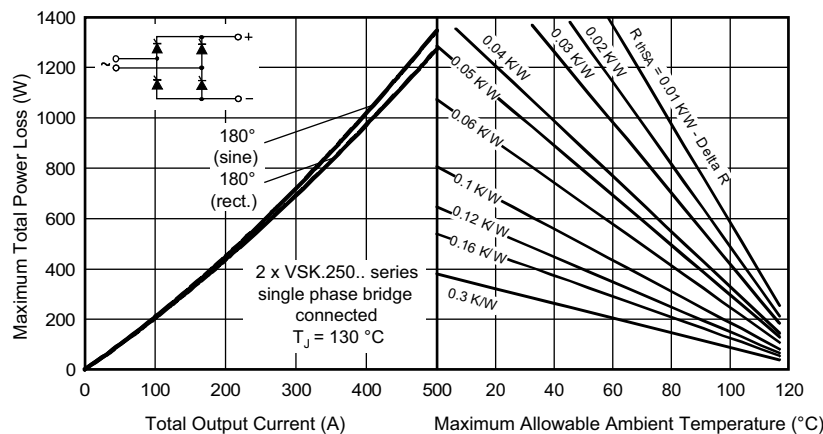

Fig. 17 - On-State Power Loss Characteristics



www.vishay.com

VS-VSK.170PbF, VS-VSK.250PbF

Vishay Semiconductors

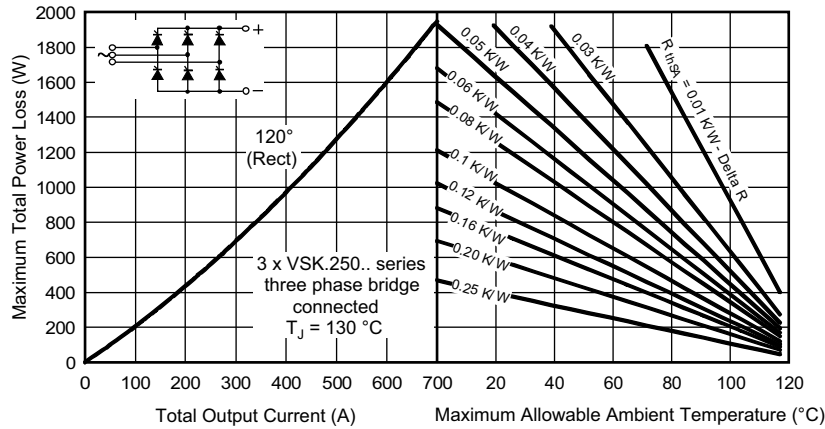

Fig. 18 - On-State Power Loss Characteristics

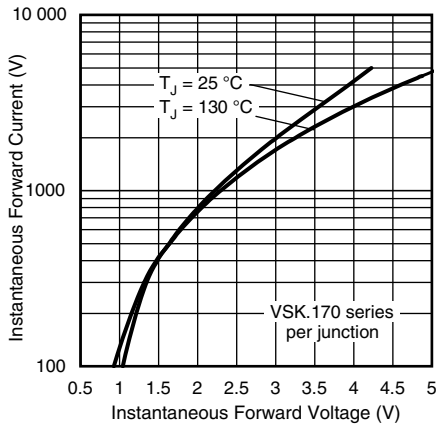

Fig. 19 - On-State Voltage Drop Characteristics

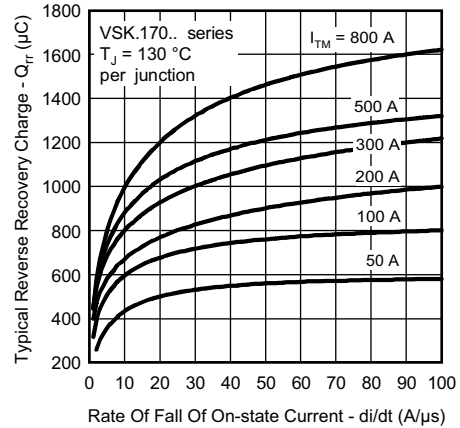

Fig. 21 - Reverse Recovery Charge Characteristics

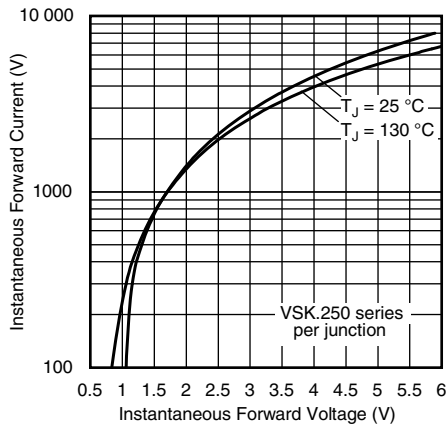

Fig. 20 - On-State Voltage Drop Characteristics

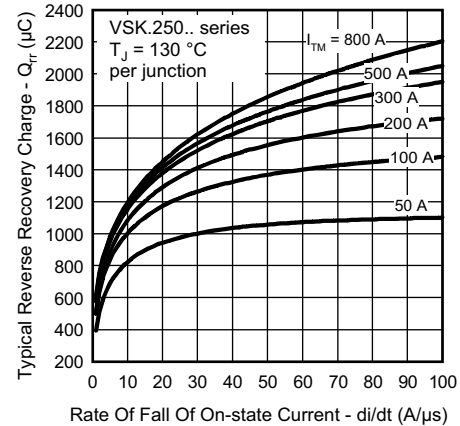

Fig. 22 - Reverse Recovery Charge Characteristics

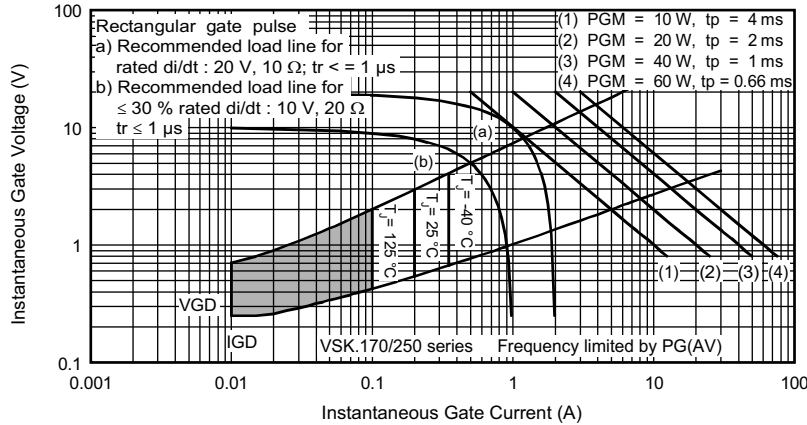

Fig. 23 - Gate Characteristics

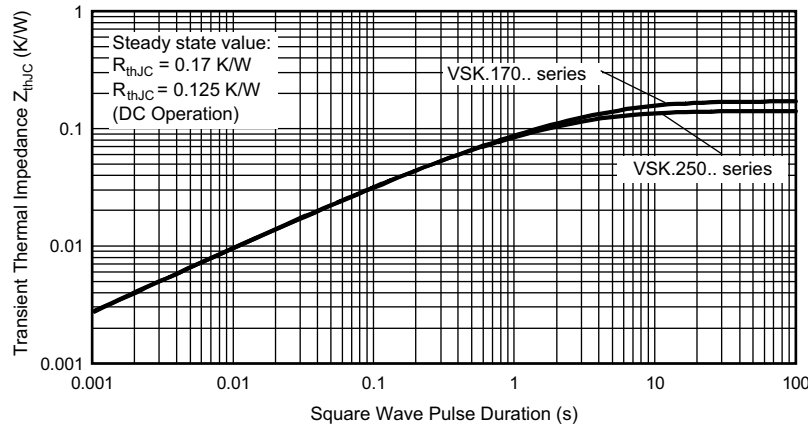

Fig. 24 - Thermal Impedance Z_{thJC} Characteristics

ORDERING INFORMATION TABLE

Device code	VS-VS	KT	250	-	20	PbF
	①	②	③	④	⑤	

- 1** - Vishay Semiconductors product
- 2** - Circuit configuration (see dimensions - link at the end of datasheet)
- 3** - Current rating
- 4** - Voltage code x 100 = V_{RRM} (see Voltage Ratings table)
- 5** -
 - None = standard production
 - PbF = lead (Pb)-free

Note

- To order the optional hardware go to www.vishay.com/doc?95172



www.vishay.com

VS-VSK.170PbF, VS-VSK.250PbF

Vishay Semiconductors

CIRCUIT CONFIGURATION		
CIRCUIT DESCRIPTION	CIRCUIT CONFIGURATION CODE	CIRCUIT DRAWING
Two SCRs doubler circuit	KT	<p>Available up to 2000 V, contact factory for different requirement</p>
SCR/diode doubler circuit, positive control	KH	<p>Available up to 2000 V, contact factory for different requirement</p>
SCR/diode doubler circuit, negative control	KL	<p>Available up to 2000 V, contact factory for different requirement</p>
Two SCRs common cathodes	KU	<p>Available up to 1200 V, contact factory for different requirement</p>

LINKS TO RELATED DOCUMENTS	
Dimensions	www.vishay.com/doc?95086



Outline Dimensions

Vishay Semiconductors

MAGN-A-PAK

DIMENSIONS in millimeters (inches)

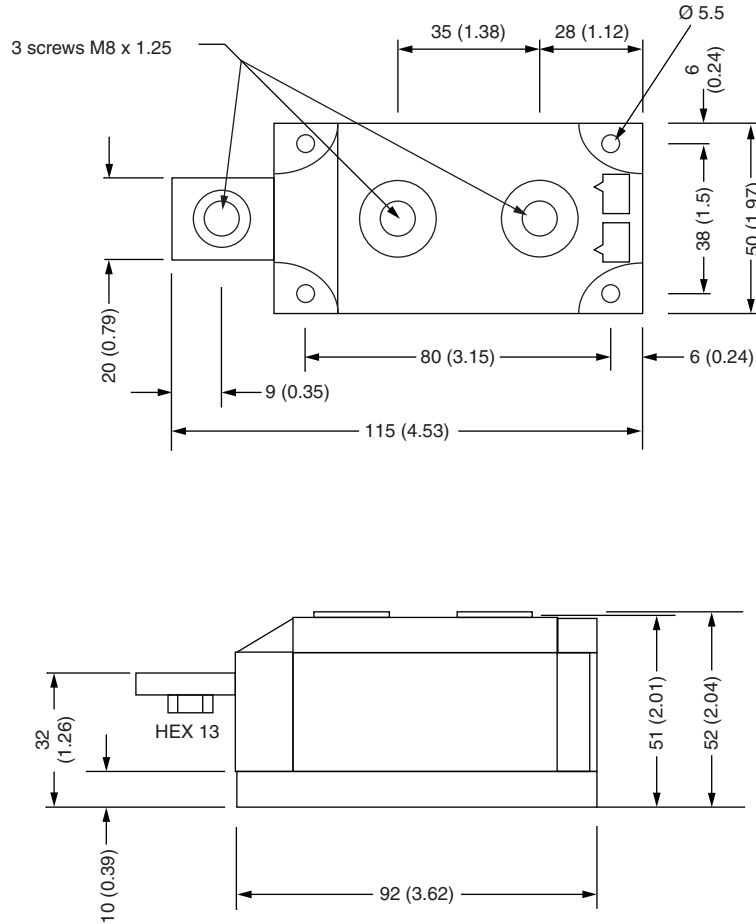

Notes

- Dimensions are nominal
- Full engineering drawings are available on request
- UL identification number for gate and cathode wire: UL 1385
- UL identification number for package: UL 94 V-0



Disclaimer

ALL PRODUCT, PRODUCT SPECIFICATIONS AND DATA ARE SUBJECT TO CHANGE WITHOUT NOTICE TO IMPROVE RELIABILITY, FUNCTION OR DESIGN OR OTHERWISE.

Vishay Intertechnology, Inc., its affiliates, agents, and employees, and all persons acting on its or their behalf (collectively, "Vishay"), disclaim any and all liability for any errors, inaccuracies or incompleteness contained in any datasheet or in any other disclosure relating to any product.

Vishay makes no warranty, representation or guarantee regarding the suitability of the products for any particular purpose or the continuing production of any product. To the maximum extent permitted by applicable law, Vishay disclaims (i) any and all liability arising out of the application or use of any product, (ii) any and all liability, including without limitation special, consequential or incidental damages, and (iii) any and all implied warranties, including warranties of fitness for particular purpose, non-infringement and merchantability.

Statements regarding the suitability of products for certain types of applications are based on Vishay's knowledge of typical requirements that are often placed on Vishay products in generic applications. Such statements are not binding statements about the suitability of products for a particular application. It is the customer's responsibility to validate that a particular product with the properties described in the product specification is suitable for use in a particular application. Parameters provided in datasheets and / or specifications may vary in different applications and performance may vary over time. All operating parameters, including typical parameters, must be validated for each customer application by the customer's technical experts. Product specifications do not expand or otherwise modify Vishay's terms and conditions of purchase, including but not limited to the warranty expressed therein.

Hyperlinks included in this datasheet may direct users to third-party websites. These links are provided as a convenience and for informational purposes only. Inclusion of these hyperlinks does not constitute an endorsement or an approval by Vishay of any of the products, services or opinions of the corporation, organization or individual associated with the third-party website. Vishay disclaims any and all liability and bears no responsibility for the accuracy, legality or content of the third-party website or for that of subsequent links.

Vishay products are not designed for use in life-saving or life-sustaining applications or any application in which the failure of the Vishay product could result in personal injury or death unless specifically qualified in writing by Vishay. Customers using or selling Vishay products not expressly indicated for use in such applications do so at their own risk. Please contact authorized Vishay personnel to obtain written terms and conditions regarding products designed for such applications.

No license, express or implied, by estoppel or otherwise, to any intellectual property rights is granted by this document or by any conduct of Vishay. Product names and markings noted herein may be trademarks of their respective owners.

OUR CERTIFICATE

DiGi provide top-quality products and perfect service for customer worldwide through standardization, technological innovation and continuous improvement. DiGi through third-party certification, we stricly control the quality of products and services. Welcome your RFQ to

Email: Info@DiGi-Electronics.com



Tel: +00 852-30501935

RFQ Email: Info@DiGi-Electronics.com

DiGi is a global authorized distributor of electronic components.