

# VS-VSKT142/08PBF Datasheet

[www.digi-electronics.com](http://www.digi-electronics.com)



<https://www.DiGi-Electronics.com>

DiGi Electronics Part Number	VS-VSKT142/08PBF-DG
Manufacturer	<a href="#">Vishay General Semiconductor - Diodes Division</a>
Manufacturer Product Number	VS-VSKT142/08PBF
Description	MODULE THYRISTOR 145A INT-A-PAK
Detailed Description	SCR Module 800 V 310 A Series Connection - All SCR s Chassis Mount INT-A-Pak

This model VS-VSKT142/08PBF is available at DiGi Electronics.

DiGi Electronics offers a global database of semiconductor and electronic component datasheets.

We welcome your inquiries regarding pricing, lead time, or other product-related questions.

 [Request a Quote](#)

 [Datasheet Search](#)



Tel: +00 852-30501935

RFQ Email: [Info@DiGi-Electronics.com](mailto:Info@DiGi-Electronics.com)

DiGi is a global authorized distributor of electronic components.

## Purchase and inquiry

Manufacturer Product Number:

VS-VSKT142/08PBF

Series:

-

Structure:

Series Connection - All SCRs

Voltage - Off State:

800 V

Current - On State (It (RMS)) (Max):

310 A

Current - Gate Trigger (Igt) (Max):

150 mA

Current - Hold (Ih) (Max):

200 mA

Mounting Type:

Chassis Mount

Base Product Number:

VSKT142

Manufacturer:

Vishay General Semiconductor - Diodes Division

Product Status:

Active

Number of SCRs, Diodes:

2 SCRs

Current - On State (It (AV)) (Max):

140 A

Voltage - Gate Trigger (Vgt) (Max):

2.5 V

Current - Non Rep. Surge 50, 60Hz (I<sub>tsm</sub>):

4500A, 4712A

Operating Temperature:

-40°C ~ 125°C (Tj)

Package / Case:

INT-A-Pak

## Environmental & Export classification

RoHS Status:

ROHS3 Compliant

REACH Status:

REACH Unaffected

HTSUS:

8541.30.0080

Moisture Sensitivity Level (MSL):

1 (Unlimited)

ECCN:

EAR99



# VS-VSK.136..PbF, VS-VSK.142..PbF, VS-VSK.162..PbF Series

[www.vishay.com](http://www.vishay.com)

Vishay Semiconductors

## Thyristor/Diode and Thyristor/Thyristor, 135 A to 160 A (INT-A-PAK Power Modules)



INT-A-PAK

PRIMARY CHARACTERISTICS	
$I_{T(AV)}$	135 A to 160 A
Type	Modules - thyristor, standard
Package	INT-A-PAK

### FEATURES

- High voltage
- Electrically isolated by DBC ceramic ( $Al_2O_3$ )
- 3500  $V_{RMS}$  isolating voltage
- Industrial standard package
- High surge capability
- Glass passivated chips
- Modules uses high voltage power thyristor/diodes in three basic configurations
- Simple mounting
- UL approved file E78996 
- Designed and qualified for multiple level
- Material categorization: for definitions of compliance please see [www.vishay.com/doc?99912](http://www.vishay.com/doc?99912)



RoHS  
COMPLIANT

### APPLICATIONS

- DC motor control and drives
- Battery charges
- Welders
- Power converters
- Lighting control
- Heat and temperature control

MAJOR RATINGS AND CHARACTERISTICS					
SYMBOL	CHARACTERISTICS	VSK.136..	VSK.142..	VSK.162..	UNITS
$I_{T(AV)}$	85 °C	135	140	160	A
$I_{T(RMS)}$		300	310	355	A
$I_{TSM}$	50 Hz	3200	4500	4870	
	60 Hz	3360	4712	5100	
$I^2t$	50 Hz	51.5	102	119	kA <sup>2</sup> s
	60 Hz	47	92.5	108	
$I^2\sqrt{t}$		515.5	1013	1190	kA <sup>2</sup> √s
$V_{RRM}$	Range	400 to 1600	400 to 1600	400 to 1600	V
$T_J$	Range	-40 to +125			°C

### ELECTRICAL SPECIFICATIONS

VOLTAGE RATINGS				
TYPE NUMBER	VOLTAGE CODE	$V_{RRM}/V_{DRM}$ , MAXIMUM REPETITIVE PEAK REVERSE VOLTAGE V	$V_{RSM}/V_{DSM}$ , MAXIMUM NON-REPETITIVE PEAK REVERSE VOLTAGE V	$I_{RRM}/I_{DRM}$ AT 125 °C mA
VS-VSK.136 VS-VSK.142 VS-VSK.162	04	400	500	50
	08	800	900	
	12	1200	1300	
	14	1400	1500	
	16	1600	1700	

**VS-VSK.136..PbF, VS-VSK.142..PbF, VS-VSK.162..PbF Series**
[www.vishay.com](http://www.vishay.com)

Vishay Semiconductors

ON-STATE CONDUCTION							
PARAMETER	SYMBOL	TEST CONDITIONS		VSK.136	VSK.142	VSK.162	UNITS
Maximum average on-state current at case temperature	$I_{T(AV)}$	180° conduction, half sine wave		135	140	160	A
				85	85	85	°C
Maximum RMS on-state current	$I_{T(RMS)}$	As AC switch		300	310	355	A
Maximum peak, one-cycle on-state, non-repetitive surge current	$I_{TSM}$	t = 10 ms	No voltage reappplied	3200	4500	4870	
		t = 8.3 ms	No voltage reappplied	3360	4712	5100	
		t = 10 ms	100 % $V_{RRM}$ reappplied	2700	3785	4100	
		t = 8.3 ms	100 % $V_{RRM}$ reappplied	2800	3963	4300	
Maximum $I^2t$ for fusing	$I^2t$	t = 10 ms	No voltage reappplied	51.5	102	119	kA <sup>2</sup> s
		t = 8.3 ms	No voltage reappplied	47	92.5	108	
		t = 10 ms	100 % $V_{RRM}$ reappplied	36.5	71.6	84	
		t = 8.3 ms	100 % $V_{RRM}$ reappplied	33.3	65.4	76.7	
Maximum $I^2\sqrt{t}$ for fusing	$I^2\sqrt{t}$	t = 0.1 ms to 10 ms, no voltage reappplied		515.5	1013	1190	kA <sup>2</sup> √s
Low level value of threshold voltage	$V_{T(TO)1}$	(16.7 % $\times \pi \times I_{T(AV)} < I < \pi \times I_{T(AV)}$ ), $T_J$ maximum		0.86	0.83	0.8	V
High level value of threshold voltage	$V_{T(TO)2}$	(I > $\pi \times I_{T(AV)}$ ), $T_J$ maximum		1.05	1	0.98	
Low level value on-state slope resistance	$r_{t1}$	(16.7 % $\times \pi \times I_{T(AV)} < I < \pi \times I_{T(AV)}$ ), $T_J$ maximum		2.02	1.78	1.67	mΩ
High level value on-state slope resistance	$r_{t2}$	(I > $\pi \times I_{T(AV)}$ ), $T_J$ maximum		1.65	1.43	1.38	
Maximum on-state voltage drop	$V_{TM}$	$I_{TM} = \pi \times I_{T(AV)}$ , $T_J = 25^\circ\text{C}$ , 180° conduction		1.57	1.55	1.54	V
Maximum forward voltage drop	$V_{FM}$	$I_{TM} = \pi \times I_{T(AV)}$ , $T_J = 25^\circ\text{C}$ , 180° conduction		1.57	1.55	1.54	V
Maximum holding current	$I_H$	Anode supply = 6 V initial $I_T = 30$ A, $T_J = 25^\circ\text{C}$		200			mA
Maximum latching current	$I_L$	Anode supply = 6 V resistive load = 1 Ω Gate pulse: 10 V, 100 μs, $T_J = 25^\circ\text{C}$		400			

SWITCHING					
PARAMETER	SYMBOL	TEST CONDITIONS		VALUES	UNITS
Typical delay time	$t_{gd}$	$T_J = 25^\circ\text{C}$	Gate current = 1 A, $di_g/dt = 1$ A/μs $V_d = 0.67\%$ $V_{DRM}$	1	μs
Typical rise time	$t_{gr}$			2	
Typical turn-off time	$t_q$	$I_{TM} = 300$ A, $-di/dt = 15$ A/μs; $T_J = T_J$ maximum $V_R = 50$ V; $dV/dt = 20$ V/μs; gate 0 V, 100 Ω		50 to 200	

BLOCKING					
PARAMETER	SYMBOL	TEST CONDITIONS		VALUES	UNITS
Maximum peak reverse and off-state leakage current	$I_{RRM}$ , $I_{DRM}$	$T_J = 125^\circ\text{C}$		50	mA
RMS insulation voltage	$V_{INS}$	50 Hz, circuit to base, all terminals shorted, t = 1 s		3500	V
Critical rate of rise of off-state voltage	$dV/dt$	$T_J = T_J$ maximum, exponential to 67 % rated $V_{DRM}$		1000	V/μs

**VS-VSK.136..PbF, VS-VSK.142..PbF, VS-VSK.162..PbF Series**
[www.vishay.com](http://www.vishay.com)

Vishay Semiconductors

TRIGGERING					
PARAMETER	SYMBOL	TEST CONDITIONS		VALUES	UNITS
Maximum peak gate power	$P_{GM}$	$t_p \leq 5$ ms, $T_J = T_J$ maximum		12	W
Maximum average gate power	$P_{G(AV)}$	$f = 50$ Hz, $T_J = T_J$ maximum		3	
Maximum peak gate current	$I_{GM}$	$t_p \leq 5$ ms, $T_J = T_J$ maximum		3	A
Maximum peak negative gate voltage	$-V_{GT}$			10	V
Maximum required DC gate voltage to trigger	$V_{GT}$	$T_J = -40$ °C	Anode supply = 6 V, resistive load; $R_a = 1$ $\Omega$	4	
		$T_J = 25$ °C		2.5	
		$T_J = T_J$ maximum		1.7	
Maximum required DC gate current to trigger	$I_{GT}$	$T_J = -40$ °C		270	mA
		$T_J = 25$ °C		150	
		$T_J = T_J$ maximum		80	
Maximum gate voltage that will not trigger	$V_{GD}$	$T_J = T_J$ maximum, rated $V_{DRM}$ applied		0.3	V
Maximum gate current that will not trigger	$I_{GD}$			10	mA
Maximum rate of rise of turned-on current	$di/dt$	$T_J = T_J$ maximum, $I_{TM} = 400$ A rated $V_{DRM}$ applied		300	A/ $\mu$ s

THERMAL AND MECHANICAL SPECIFICATIONS						
PARAMETER	SYMBOL	TEST CONDITIONS	VSK.136	VSK.142	VSK.162	UNITS
Maximum junction operating temperature range	$T_J$		-40 to +125			°C
Maximum storage temperature range	$T_{Stg}$		-40 to +150			
Maximum thermal resistance, junction to case per junction	$R_{thJC}$	DC operation	0.18	0.18	0.16	K/W
Maximum thermal resistance, case to heatsink per module	$R_{thCS}$	Mounting surface, smooth, flat and greased	0.05			
Mounting torque $\pm 10$ %	IAP to heatsink busbar to IAP	A mounting compound is recommended and the torque should be rechecked after a period of 3 hours to allow for the spread of the compound. Lubricated threads.	4 to 6			Nm
Approximate weight			200			g
Case style			7.1			oz.
			INT-A-PAK			

$\Delta R$ CONDUCTION PER JUNCTION											
DEVICES	SINUSOIDAL CONDUCTION AT $T_J$ MAXIMUM					RECTANGULAR CONDUCTION AT $T_J$ MAXIMUM					UNITS
	180°	120°	90°	60°	30°	180°	120°	90°	60°	30°	
VSK.136	0.007	0.01	0.013	0.0155	0.017	0.009	0.012	0.014	0.015	0.017	K/W
VSK.142	0.0019	0.0019	0.0020	0.0020	0.0021	0.0018	0.0022	0.0023	0.0023	0.0020	
VSK.162	0.0030	0.0031	0.0032	0.0033	0.0034	0.0029	0.0036	0.0039	0.0041	0.0040	

**Note**

- Table shows the increment of thermal resistance  $R_{thJC}$  when devices operate at different conduction angles than DC



# VS-VSK.136..PbF, VS-VSK.142..PbF, VS-VSK.162..PbF Series

[www.vishay.com](http://www.vishay.com)

Vishay Semiconductors

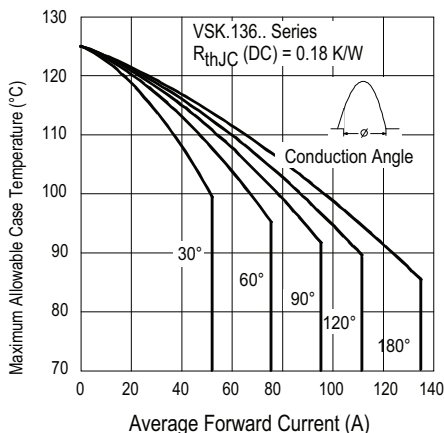

Fig. 1 - Current Ratings Characteristics

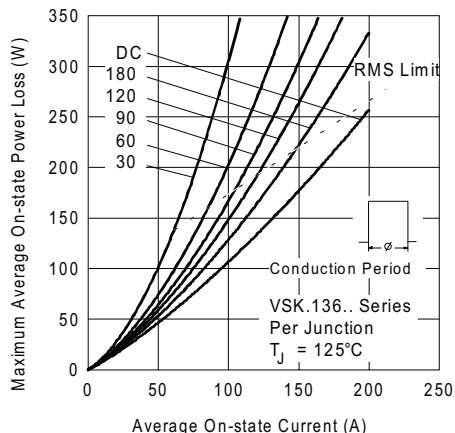

Fig. 4 - On-State Power Loss Characteristics

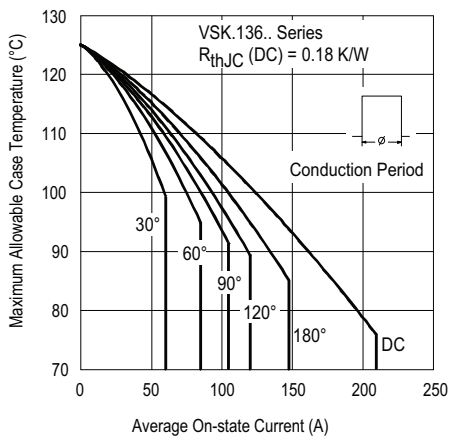

Fig. 2 - Current Ratings Characteristics

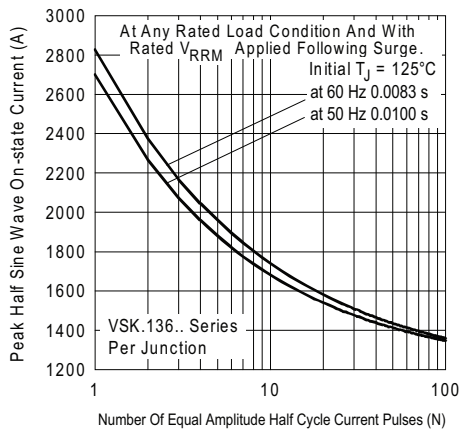

Fig. 5 - Maximum Non-Repetitive Surge Current

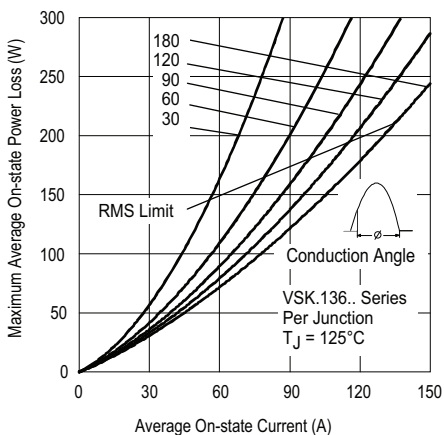

Fig. 3 - On-State Power Loss Characteristics

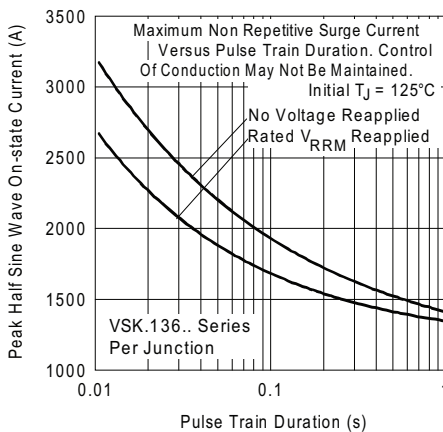

Fig. 6 - Maximum Non-Repetitive Surge Current



# VS-VSK.136..PbF, VS-VSK.142..PbF, VS-VSK.162..PbF Series

[www.vishay.com](http://www.vishay.com)

Vishay Semiconductors

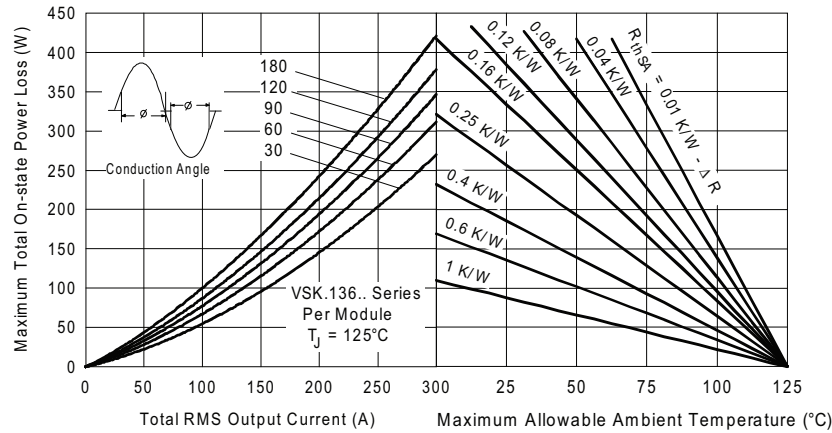

Fig. 7 - On-State Power Loss Characteristics

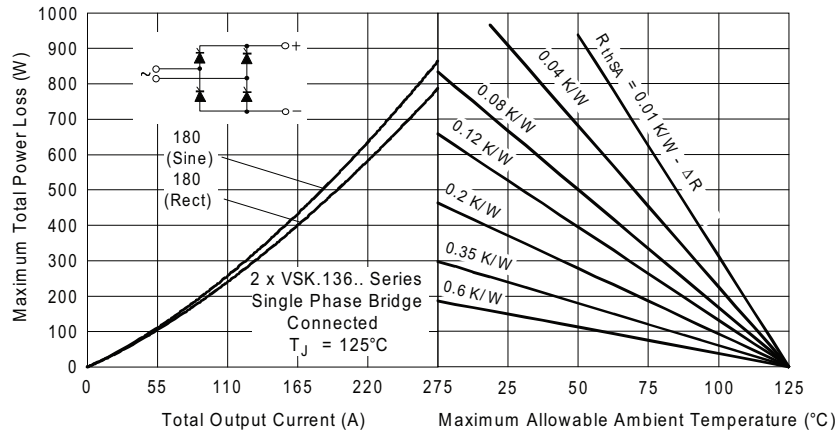

Fig. 8 - On-State Power Loss Characteristics

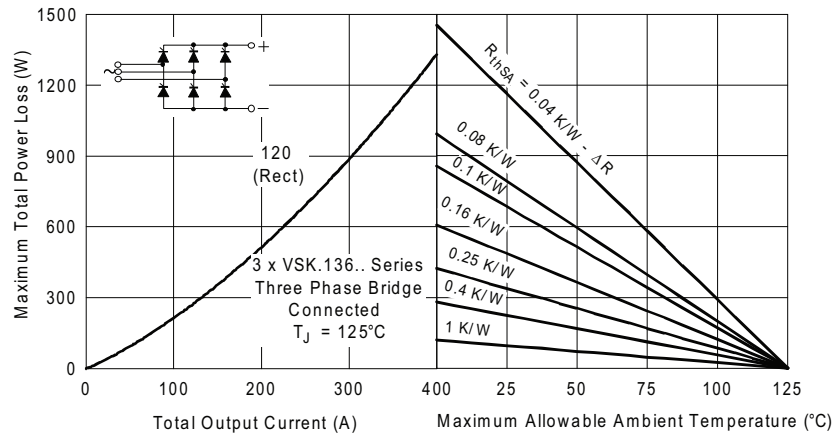

Fig. 9 - On-State Power Loss Characteristics



# VS-VSK.136..PbF, VS-VSK.142..PbF, VS-VSK.162..PbF Series

[www.vishay.com](http://www.vishay.com)

Vishay Semiconductors

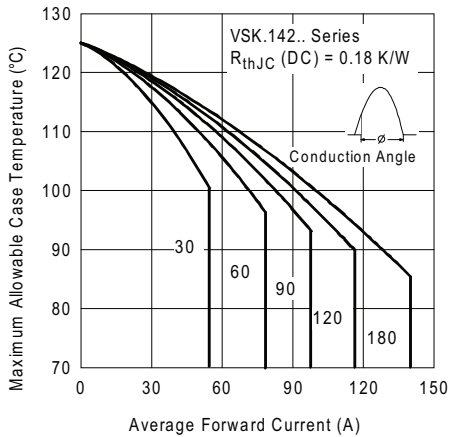

Fig. 10 - Current Ratings Characteristics

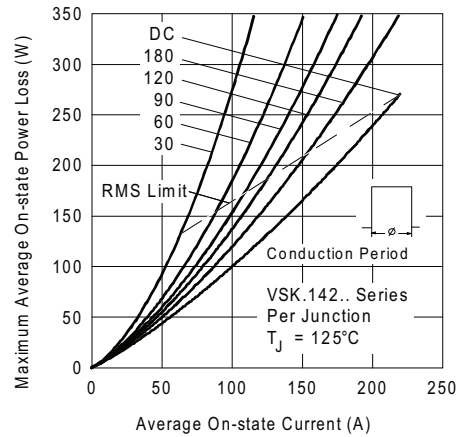

Fig. 13 - On-State Power Loss Characteristics

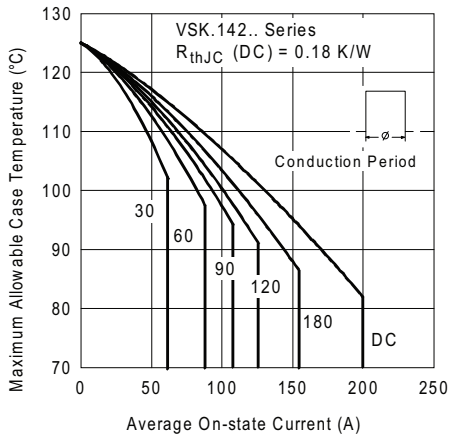

Fig. 11 - Current Ratings Characteristics

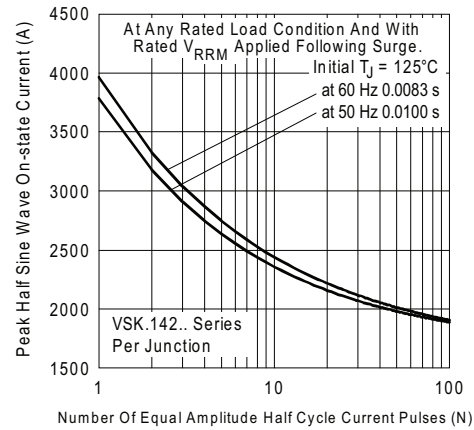

Fig. 14 - Maximum Non-Repetitive Surge Current

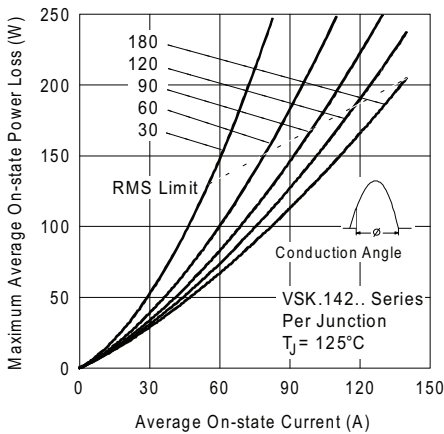

Fig. 12 - On-State Power Loss Characteristics

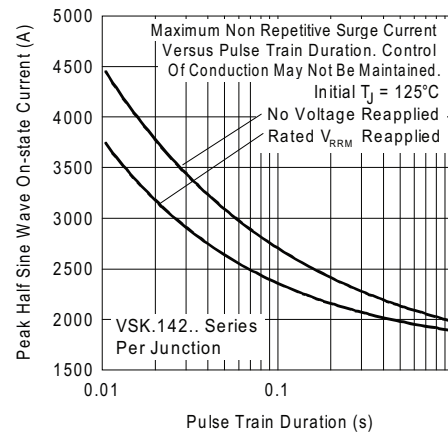

Fig. 15 - Maximum Non-Repetitive Surge Current



# VS-VSK.136..PbF, VS-VSK.142..PbF, VS-VSK.162..PbF Series

[www.vishay.com](http://www.vishay.com)

Vishay Semiconductors

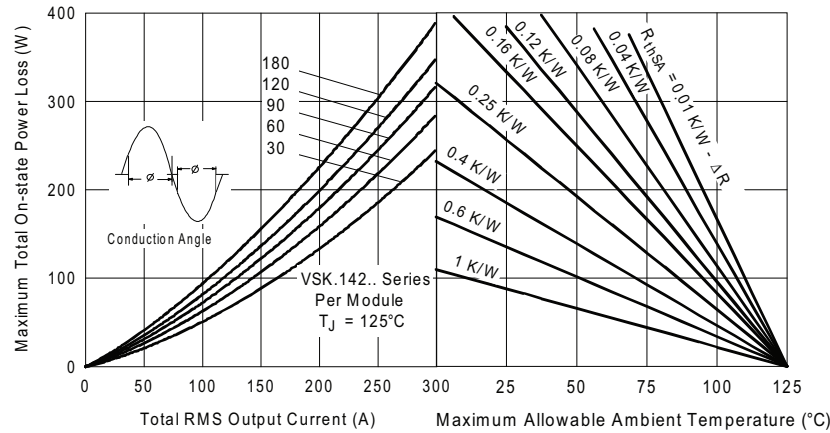

Fig. 16 - On-State Power Loss Characteristics

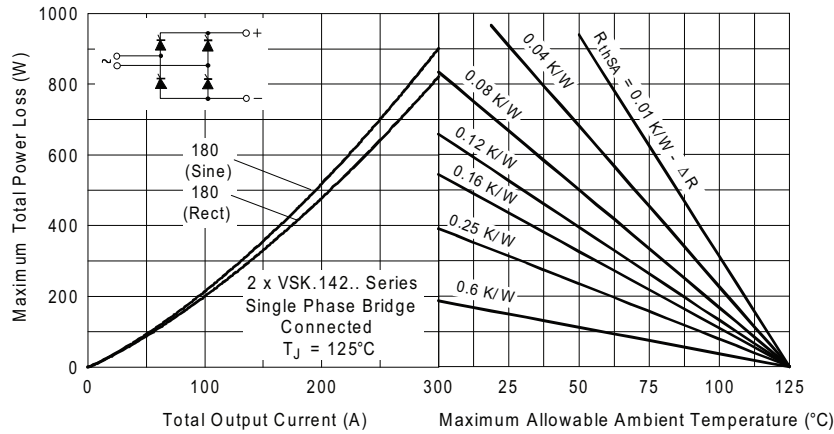

Fig. 17 - On-State Power Loss Characteristics

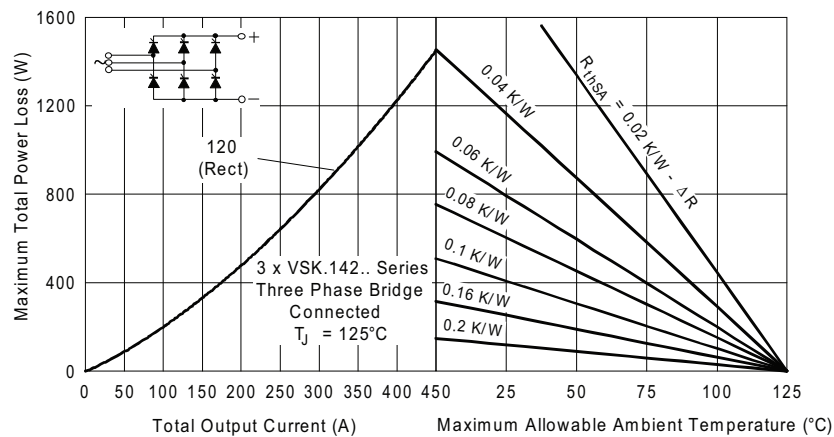

Fig. 18 - On-State Power Loss Characteristics



# VS-VSK.136..PbF, VS-VSK.142..PbF, VS-VSK.162..PbF Series

[www.vishay.com](http://www.vishay.com)

Vishay Semiconductors

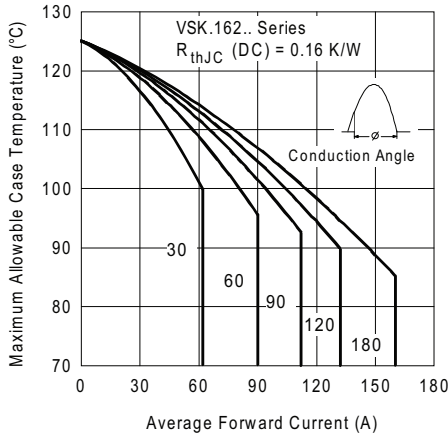

Fig. 19 - Current Ratings Characteristics

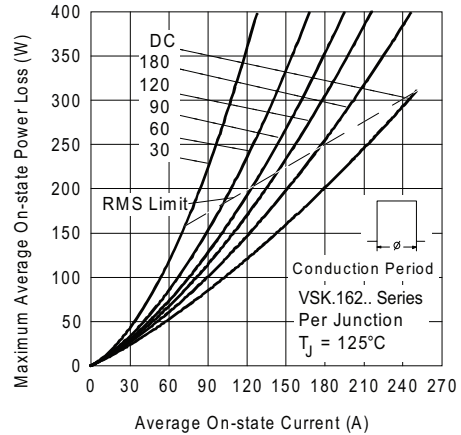

Fig. 22 - On-State Power Loss Characteristics

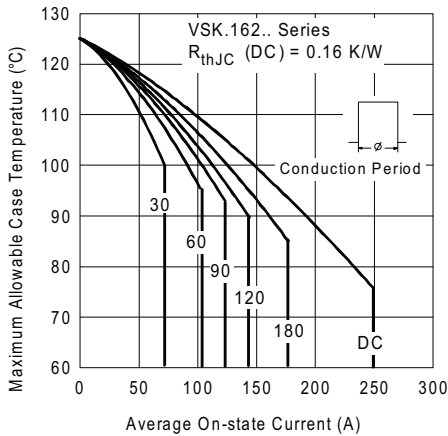

Fig. 20 - Current Ratings Characteristics

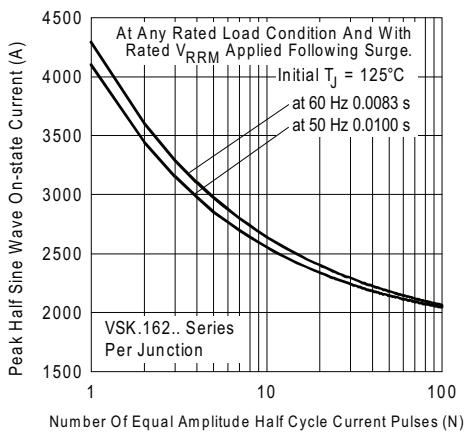

Fig. 23 - Maximum Non-Repetitive Surge Current

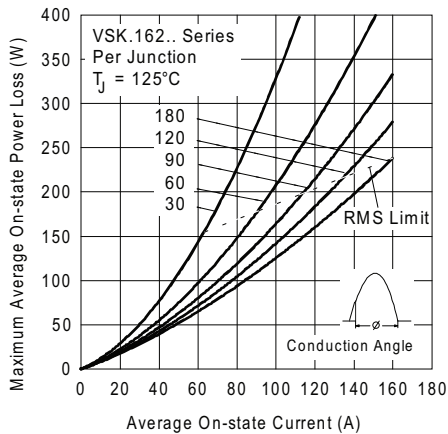

Fig. 21 - On-State Power Loss Characteristics

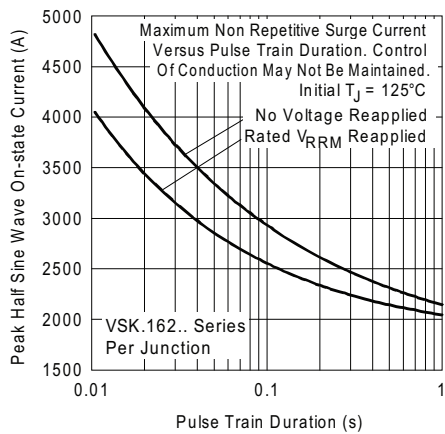

Fig. 24 - Maximum Non-Repetitive Surge Current



# VS-VSK.136..PbF, VS-VSK.142..PbF, VS-VSK.162..PbF Series

[www.vishay.com](http://www.vishay.com)

Vishay Semiconductors

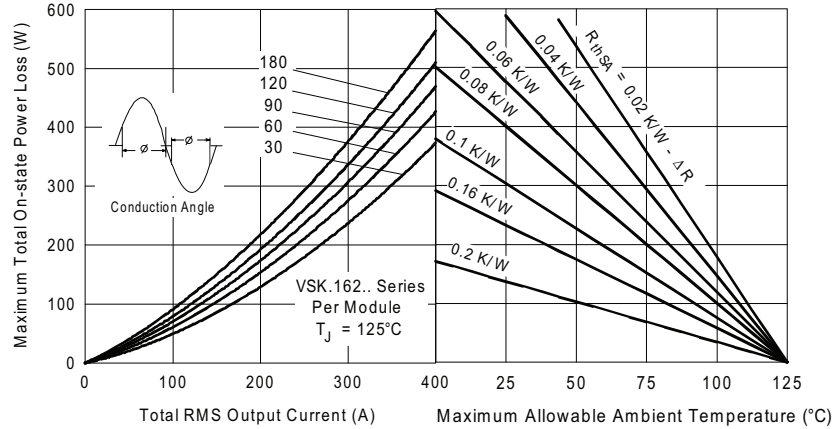

Fig. 25 - On-State Power Loss Characteristics

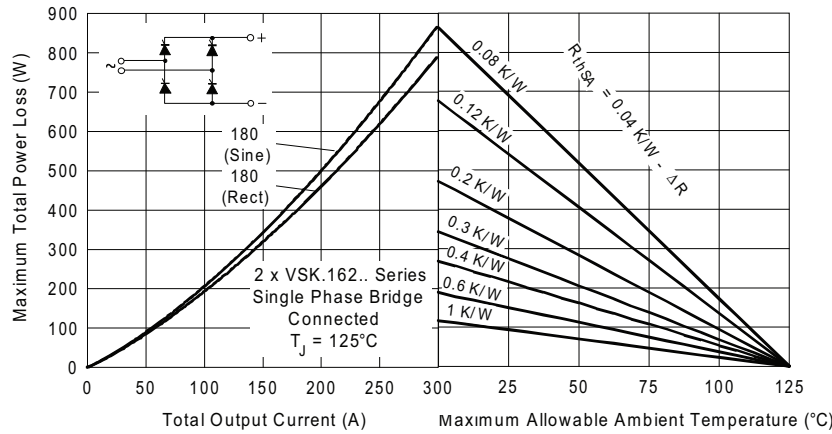

Fig. 26 - On-State Power Loss Characteristics

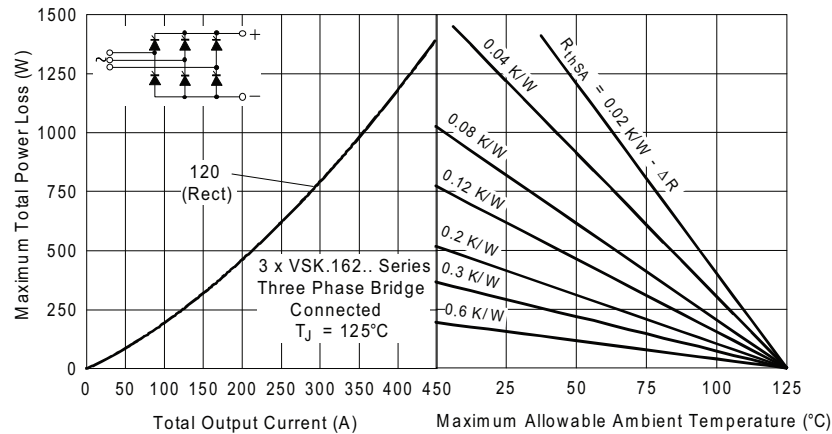

Fig. 27 - On-State Power Loss Characteristics



# VS-VSK.136..PbF, VS-VSK.142..PbF, VS-VSK.162..PbF Series

[www.vishay.com](http://www.vishay.com)

Vishay Semiconductors

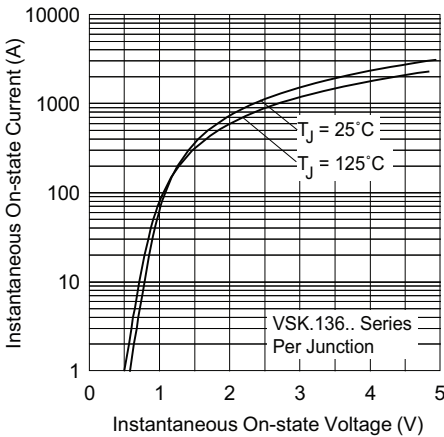

Fig. 28 - On-State Voltage Drop Characteristics

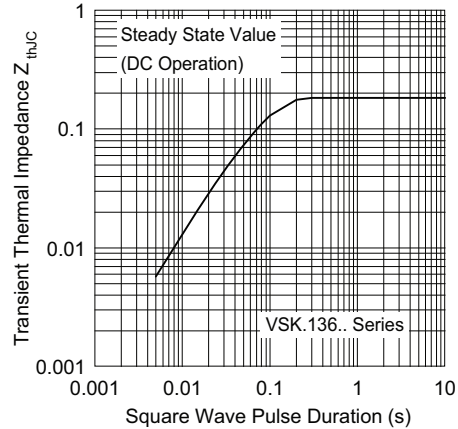

Fig. 31 - Thermal Impedance  $Z_{thJC}$  Characteristics

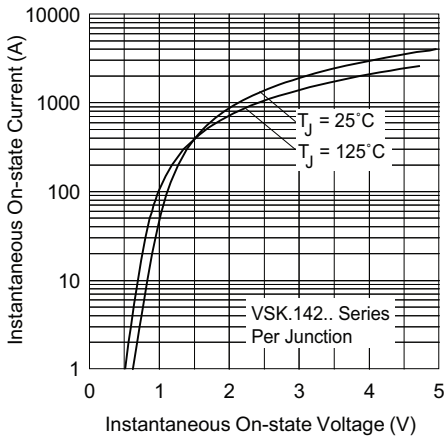

Fig. 29 - On-State Voltage Drop Characteristics

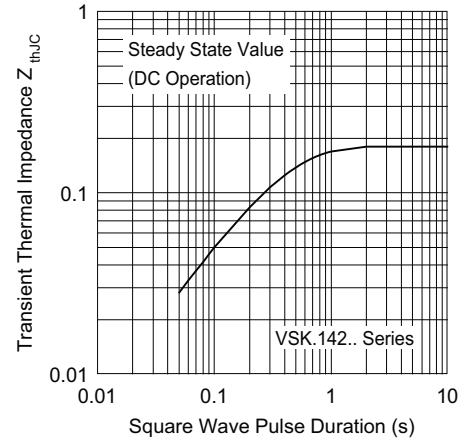

Fig. 32 - Thermal Impedance  $Z_{thJC}$  Characteristics

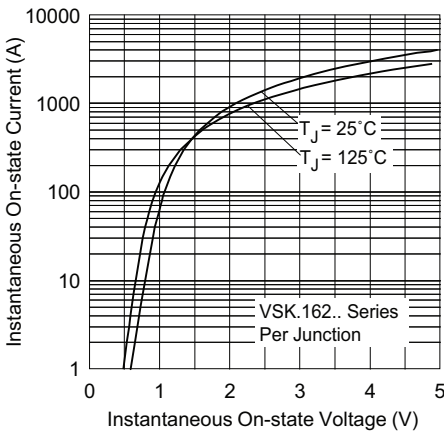

Fig. 30 - On-State Voltage Drop Characteristics

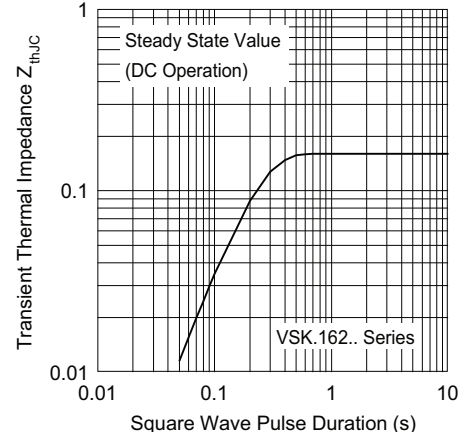

Fig. 33 - Thermal Impedance  $Z_{thJC}$  Characteristics



# VS-VSK.136..PbF, VS-VSK.142..PbF, VS-VSK.162..PbF Series

[www.vishay.com](http://www.vishay.com)

Vishay Semiconductors

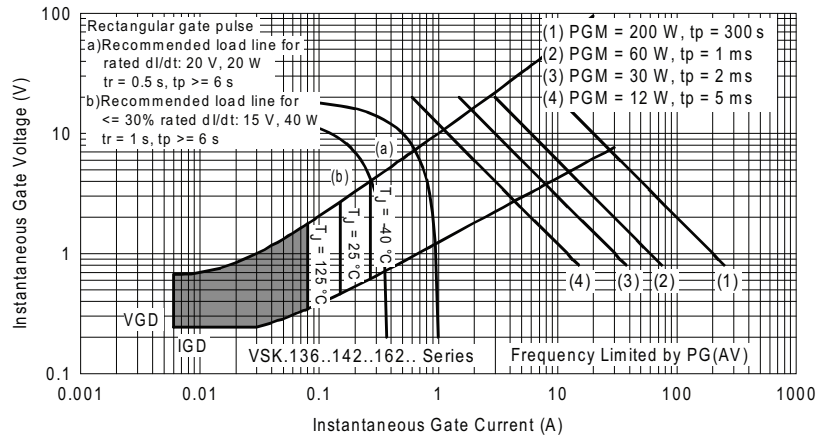

Fig. 34 - Gate Characteristics

## ORDERING INFORMATION TABLE

Device code	VS-VS	KT	162	16	PbF
	①	②	③	④	⑤
	1	2	3	4	5
	1	-	-	-	-
	2	-	-	-	-
	3	-	-	-	-
	4	-	-	-	-
	5	-	-	-	-

1 - Vishay Semiconductors product  
 2 - Circuit configuration  
 3 - Current rating:  $I_{T(AV)}$   
 4 - Voltage code x 100 =  $V_{RRM}$   
 5 - PbF = Lead (Pb)-free

### Note

- To order the optional hardware go to [www.vishay.com/doc?95172](http://www.vishay.com/doc?95172)



**VS-VSK.136..PbF, VS-VSK.142..PbF, VS-VSK.162..PbF Series**

[www.vishay.com](http://www.vishay.com)

Vishay Semiconductors

CIRCUIT CONFIGURATION		
CIRCUIT DESCRIPTION	CIRCUIT CONFIGURATION CODE	CIRCUIT DRAWING
Two SCRs doubler circuit	T	
SCR/diode doubler circuit, positive control	H	
SCR/diode doubler circuit, negative control	L	

LINKS TO RELATED DOCUMENTS	
Dimensions	<a href="http://www.vishay.com/doc?95067">www.vishay.com/doc?95067</a>



# Outline Dimensions

Vishay Semiconductors

## INT-A-PAK IGBT/Thyristor

**DIMENSIONS** in millimeters (inches)

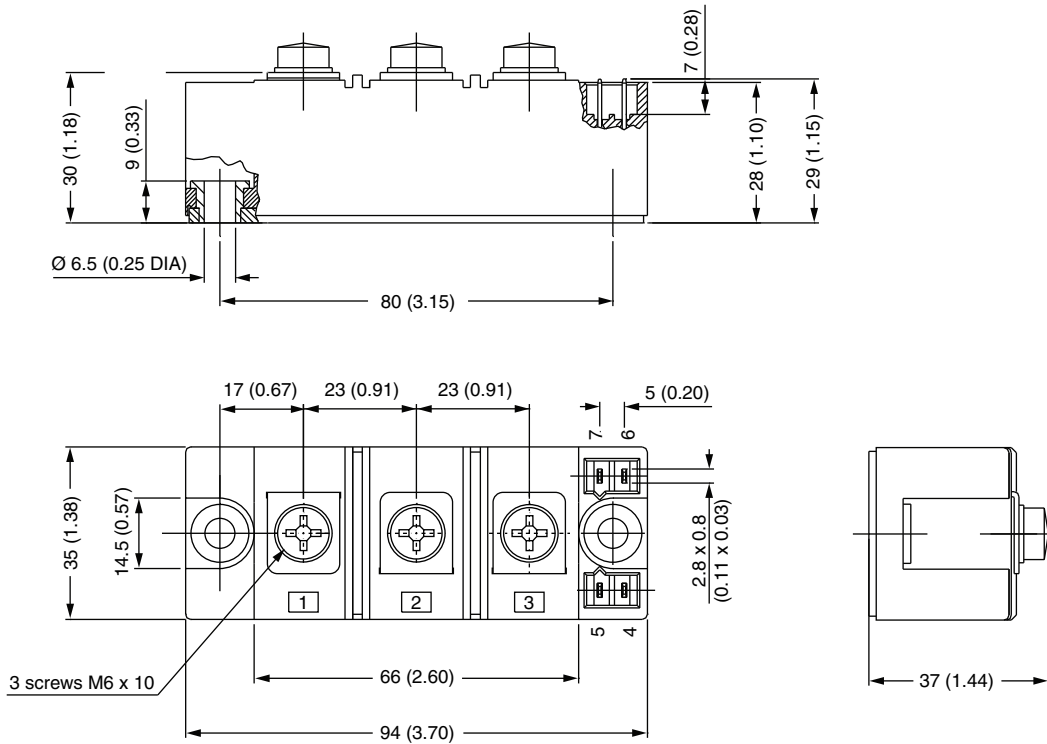



## Disclaimer

ALL PRODUCT, PRODUCT SPECIFICATIONS AND DATA ARE SUBJECT TO CHANGE WITHOUT NOTICE TO IMPROVE RELIABILITY, FUNCTION OR DESIGN OR OTHERWISE.

Vishay Intertechnology, Inc., its affiliates, agents, and employees, and all persons acting on its or their behalf (collectively, "Vishay"), disclaim any and all liability for any errors, inaccuracies or incompleteness contained in any datasheet or in any other disclosure relating to any product.

Vishay makes no warranty, representation or guarantee regarding the suitability of the products for any particular purpose or the continuing production of any product. To the maximum extent permitted by applicable law, Vishay disclaims (i) any and all liability arising out of the application or use of any product, (ii) any and all liability, including without limitation special, consequential or incidental damages, and (iii) any and all implied warranties, including warranties of fitness for particular purpose, non-infringement and merchantability.

Statements regarding the suitability of products for certain types of applications are based on Vishay's knowledge of typical requirements that are often placed on Vishay products in generic applications. Such statements are not binding statements about the suitability of products for a particular application. It is the customer's responsibility to validate that a particular product with the properties described in the product specification is suitable for use in a particular application. Parameters provided in datasheets and / or specifications may vary in different applications and performance may vary over time. All operating parameters, including typical parameters, must be validated for each customer application by the customer's technical experts. Product specifications do not expand or otherwise modify Vishay's terms and conditions of purchase, including but not limited to the warranty expressed therein.

Hyperlinks included in this datasheet may direct users to third-party websites. These links are provided as a convenience and for informational purposes only. Inclusion of these hyperlinks does not constitute an endorsement or an approval by Vishay of any of the products, services or opinions of the corporation, organization or individual associated with the third-party website. Vishay disclaims any and all liability and bears no responsibility for the accuracy, legality or content of the third-party website or for that of subsequent links.

Vishay products are not designed for use in life-saving or life-sustaining applications or any application in which the failure of the Vishay product could result in personal injury or death unless specifically qualified in writing by Vishay. Customers using or selling Vishay products not expressly indicated for use in such applications do so at their own risk. Please contact authorized Vishay personnel to obtain written terms and conditions regarding products designed for such applications.

No license, express or implied, by estoppel or otherwise, to any intellectual property rights is granted by this document or by any conduct of Vishay. Product names and markings noted herein may be trademarks of their respective owners.

## OUR CERTIFICATE

DiGi provide top-quality products and perfect service for customer worldwide through standardization, technological innovation and continuous improvement. DiGi through third-party certification, we stricly control the quality of products and services. Welcome your RFQ to

Email: [Info@DiGi-Electronics.com](mailto:Info@DiGi-Electronics.com)



Tel: +00 852-30501935

RFQ Email: [Info@DiGi-Electronics.com](mailto:Info@DiGi-Electronics.com)

DiGi is a global authorized distributor of electronic components.