

IL4216-X001 Datasheet

www.digi-electronics.com

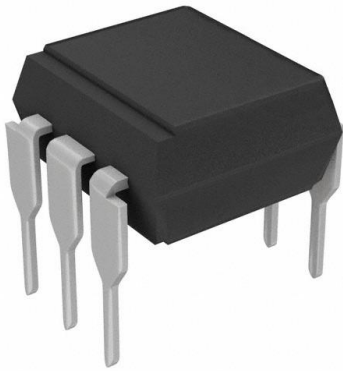

<https://www.DiGi-Electronics.com>

DiGi Electronics Part Number	IL4216-X001-DG
Manufacturer	Vishay Semiconductor Opto Division
Manufacturer Product Number	IL4216-X001
Description	OPTOISOLATOR 5.3KV TRIAC 6DIP
Detailed Description	Optoisolator Triac Output 5300Vrms 1 Channel 6-DIP

This model IL4216-X001 is available at DiGi Electronics.

DiGi Electronics offers a global database of semiconductor and electronic component datasheets.

We welcome your inquiries regarding pricing, lead time, or other product-related questions.

 [Request a Quote](#)

 [Datasheet Search](#)



Tel: +00 852-30501935

RFQ Email: Info@DiGi-Electronics.com

DiGi is a global authorized distributor of electronic components.

Purchase and inquiry

Manufacturer Product Number:

IL4216-X001

Series:

-

Output Type:

Triac

Number of Channels:

1

Voltage - Off State:

600 V

Current - LED Trigger (I_{ft}) (Max):

700µA (Typ)

Current - Hold (I_h):

200µA

Voltage - Forward (V_f) (Typ):

1.3V

Operating Temperature:

-55°C ~ 100°C

Package / Case:

6-DIP (0.300", 7.62mm)

Approval Agency:

BSI, CSA, cUR, FIMKO, UR, VDE

Manufacturer:

Vishay Semiconductor Opto Division

Product Status:

Active

Zero Crossing Circuit:

No

Voltage - Isolation:

5300Vrms

Static dV/dt (Min):

10kV/µs

Current - On State (I_t (RMS)) (Max):

300 mA

Turn On Time:

-

Current - DC Forward (I_f) (Max):

60 mA

Mounting Type:

Through Hole

Supplier Device Package:

6-DIP

Base Product Number:

IL4216

Environmental & Export classification

RoHS Status:

ROHS3 Compliant

ECCN:

EAR99

Moisture Sensitivity Level (MSL):

1 (Unlimited)

HTSUS:

8541.49.8000

www.vishay.com

IL4216, IL4217, IL4218

Vishay Semiconductors

ABSOLUTE MAXIMUM RATINGS ($T_{amb} = 25\text{ }^{\circ}\text{C}$, unless otherwise specified)					
PARAMETER	TEST CONDITION	PART	SYMBOL	VALUE	UNIT
INPUT					
Reverse voltage			V_R	6	V
Forward current			I_F	60	mA
Surge current			I_{FSM}	2.5	A
Power dissipation			P_{diss}	100	mW
Derate linearly from 25 °C				1.33	mW/°C
Thermal resistance			R_{th}	750	°C/W
OUTPUT					
Peak off-state voltage		IL4216	V_{DRM}	600	V
		IL4217	V_{DRM}	700	V
		IL4218	V_{DRM}	800	V
RMS on-state current			I_{DRM}	300	mA
Single cycle surge			I_{TSM}	3	A
Power dissipation			P_{diss}	300	mW
Derate linearly from 25 °C				6.6	mW/°C
Thermal resistance			R_{th}	150	°C/W
COUPLER					
Storage temperature			T_{stg}	-55 to +150	°C
Ambient temperature			T_{amb}	-55 to +100	°C
Lead soldering temperature ⁽¹⁾	5 s		T_{slid}	260	°C

Notes

- Stresses in excess of the absolute maximum ratings can cause permanent damage to the device. Functional operation of the device is not implied at these or any other conditions in excess of those given in the operational sections of this document. Exposure to absolute maximum ratings for extended periods of the time can adversely affect reliability

⁽¹⁾ Refer to reflow profile for soldering conditions for surface mounted devices (SMD). Refer to wave profile for soldering conditions for through hole devices (DIP)

ELECTRICAL CHARACTERISTICS ($T_{amb} = 25\text{ }^{\circ}\text{C}$, unless otherwise specified)							
PARAMETER	TEST CONDITION	PART	SYMBOL	MIN.	TYP.	MAX.	UNIT
INPUT							
Forward voltage	$I_F = 20\text{ mA}$		V_F	-	1.3	1.5	V
Breakdown voltage	$I_R = 10\text{ }\mu\text{A}$		V_{BR}	6	30	-	V
Reverse current	$V_R = 6\text{ V}$		I_R	-	0.1	10	μA
Input capacitance	$V_F = 0\text{ V}$, $f = 1\text{ MHz}$		C_{IN}	-	40	-	pF
Thermal resistance, junction to lead			R_{thjl}	-	750	-	°C/W
OUTPUT							
Repetitive peak off-state voltage	$I_{DRM} = 100\text{ }\mu\text{A}$	IL4216	V_{DRM}	600	650	-	V
		IL4217	V_{DRM}	700	750	-	V
		IL4218	V_{DRM}	800	850	-	V
Off-state voltage	$I_{D(RMS)} = 70\text{ }\mu\text{A}$	IL4216	$V_{D(RMS)}$	424	460	-	V
		IL4217	$V_{D(RMS)}$	484	536	-	V
		IL4218	$V_{D(RMS)}$	565	613	-	V
Off-state current	$V_D = 600\text{ V}$, $T_{amb} = 100\text{ }^{\circ}\text{C}$		$I_{D(RMS)}$	-	10	100	μA
Reverse current	$V_R = 600\text{ V}$, $T_{amb} = 25\text{ }^{\circ}\text{C}$		I_{RMS}	-	10	100	μA
On-state voltage	$I_T = 300\text{ mA}$		V_{TM}	-	1.7	3	V
On-state current	$PF = 1$, $V_{T(RMS)} = 1.7\text{ V}$		I_{TM}	-	-	300	mA
Surge (non-repetitive, on-state current)	$f = 50\text{ Hz}$		I_{TSM}	-	-	3	A
Holding current	$V_T = 3\text{ V}$		I_H	-	65	200	μA
Latching current	$V_T = 2.2\text{ V}$		I_L	-	-	500	μA
LED trigger current	$V_{AK} = 5\text{ V}$		I_{FT}	-	0.7	-	mA



ELECTRICAL CHARACTERISTICS ($T_{amb} = 25\text{ }^{\circ}\text{C}$, unless otherwise specified)							
PARAMETER	TEST CONDITION	PART	SYMBOL	MIN.	TYP.	MAX.	UNIT
OUTPUT							
Critical rate of rise of off-state voltage	$V_D = 0.67 V_{DRM}, T_{amb} = 25\text{ }^{\circ}\text{C}$		dV/dt_{cr}	10 000	-	-	V/ μs
	$V_D = 0.67 V_{DRM}, T_{amb} = 80\text{ }^{\circ}\text{C}$		dV/dt_{cr}	5000	-	-	V/ μs
Critical rate of rise of voltage at current commutation	$V_D = 230 V_{RMS}, I_D = 300 \text{ mA}_{RMS}, T_J = 25\text{ }^{\circ}\text{C}$		dV/dt_{crq}	-	8	-	V/ μs
	$V_D = 230 V_{RMS}, I_D = 300 \text{ mA}_{RMS}, T_J = 85\text{ }^{\circ}\text{C}$		dV/dt_{crq}	-	7	-	V/ μs
Critical rate of rise of on-state current commutation	$V_D = 230 V_{RMS}, I_D = 300 \text{ mA}_{RMS}, T_J = 25\text{ }^{\circ}\text{C}$		dI/dt_{crq}	-	12	-	A/ms
Thermal resistance, junction to lead			R_{thjl}	-	150	-	$^{\circ}\text{C}/\text{W}$
COUPLER							
Capacitance (input to output)	$f = 1 \text{ MHz}, V_{IO} = 0 \text{ V}$		C_{IO}	-	0.8	-	pF
Critical rate of rise of coupled input to output voltage	$I_T = 0, V_{RM} = V_{DM} = 300 V_{AC}$		$dV_{(IO)}/dt$	5000	1	-	mA

Note

- Minimum and maximum values are testing requirements. Typical values are characteristics of the device and are the result of engineering evaluation. Typical values are for information only and are not part of the testing requirements

POWER FACTOR CONSIDERATIONS

A snubber is not needed to eliminate false operation of the TRIAC driver because of the IL4216, IL4217, IL4218 high static and commutating dV/dt with loads between 1 and 0.8 power factors. When inductive loads with power factors less than 0.8 are being driven, include a RC snubber or a single capacitor directly across the device to damp the peak commutating dV/dt spike. Normally a commutating dV/dt causes a turning-off device to stay on due to the stored energy remaining in the turning-off device.

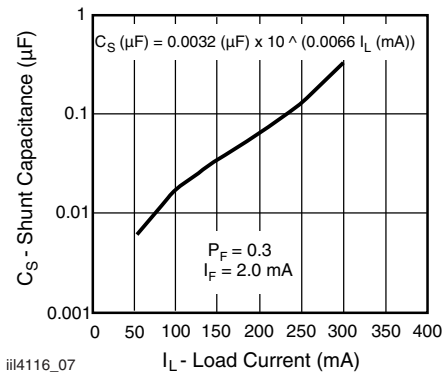

Fig. 1 - Shunt Capacitance vs. Load Current vs. Power Factor

SAFETY AND INSULATION RATINGS				
PARAMETER	TEST CONDITION	SYMBOL	VALUE	UNIT
Climatic classification	According to IEC 68 part 1		55 / 100 / 21	
Comparative tracking index		CTI	175	
Maximum rated withstanding isolation voltage	$t = 1 \text{ min}$	V_{ISO}	4420	V_{RMS}
Maximum transient isolation voltage		V_{IOTM}	8000	V_{peak}
Maximum repetitive peak isolation voltage		V_{IORM}	890	V_{peak}
Isolation resistance	$V_{IO} = 500 \text{ V}, T_{amb} = 25\text{ }^{\circ}\text{C}$	R_{IO}	$\geq 10^{12}$	Ω
	$V_{IO} = 500 \text{ V}, T_{amb} = 100\text{ }^{\circ}\text{C}$	R_{IO}	$\geq 10^{11}$	Ω
Output safety power		P_{SO}	500	mW
Input safety current		I_{SI}	250	mA
Safety temperature		T_S	175	$^{\circ}\text{C}$
Creepage distance	DIP-6; SMD-6, option 7; SMD-6, option 9		≥ 7	mm
	DIP-6, 400 mil, option 6		≥ 8	mm
Clearance distance	DIP-6; SMD-6, option 7; SMD-6, option 9		≥ 7	mm
	DIP-6, 400 mil, option 6		≥ 8	mm
Insulation thickness		DTI	≥ 0.4	mm

Note

- As per IEC 60747-5-5, § 7.4.3.8.2, this optocoupler is suitable for “safe electrical insulation” only within the safety ratings. Compliance with the safety ratings shall be ensured by means of protective circuits



TYPICAL CHARACTERISTICS ($T_{amb} = 25\text{ }^{\circ}\text{C}$, unless otherwise specified)

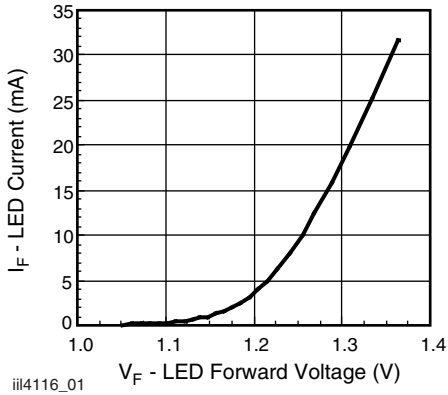

Fig. 2 - LED Forward Current vs. Forward Voltage

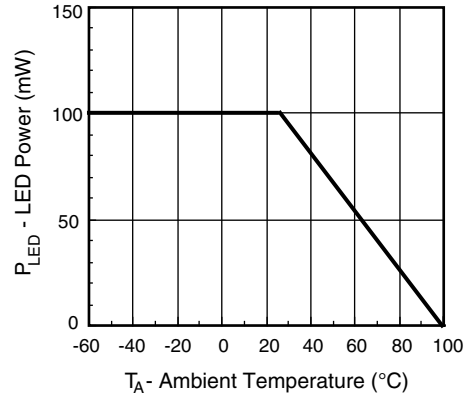

Fig. 5 - Maximum LED Power Dissipation

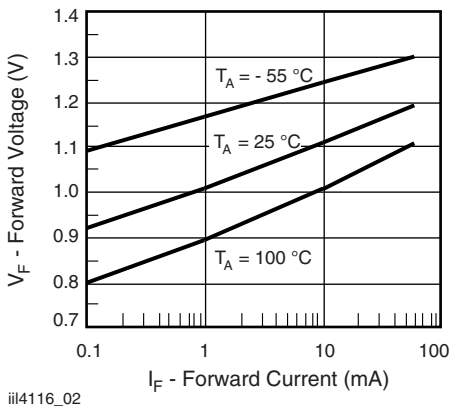

Fig. 3 - Forward Voltage vs. Forward Current

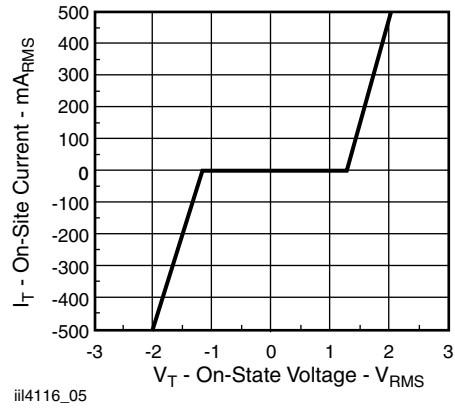

Fig. 6 - On-State Terminal Voltage vs. Terminal Current

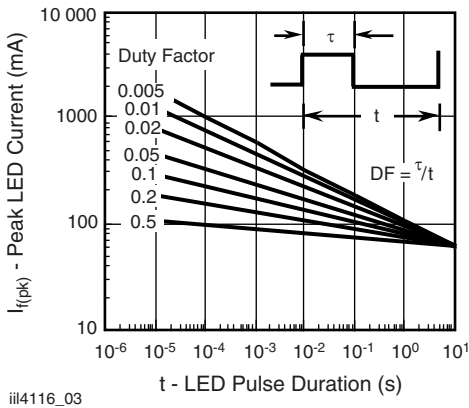

Fig. 4 - Peak LED Current vs. Duty Factor, τ

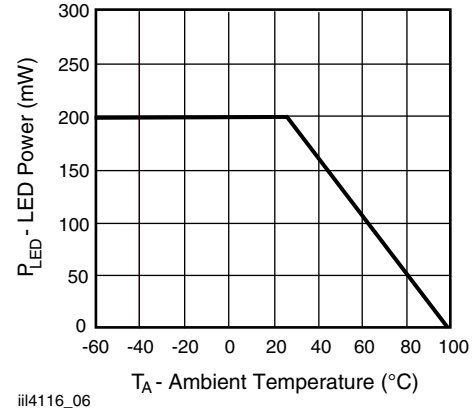
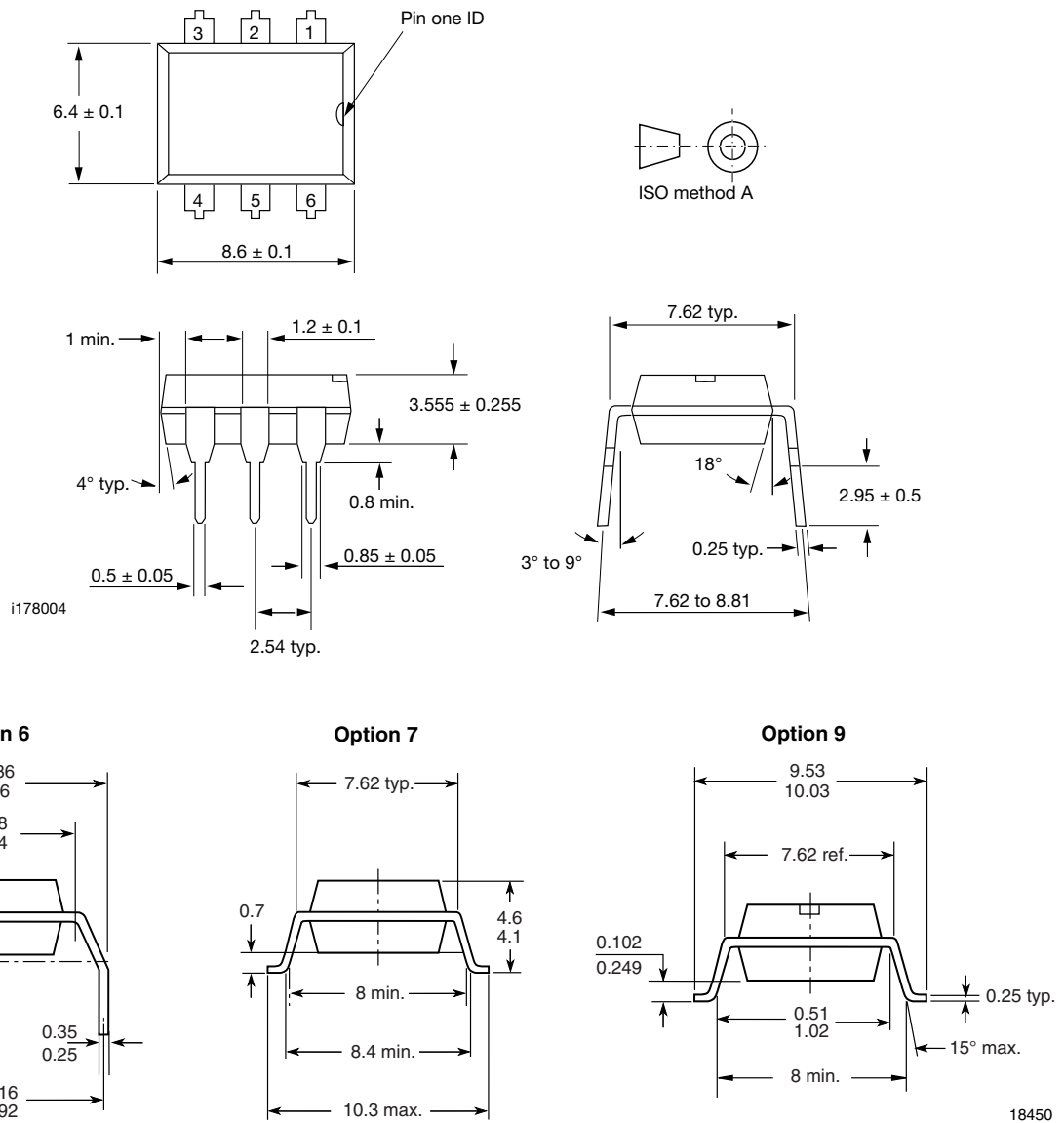

Fig. 7 - Maximum Output Power Dissipation



PACKAGE DIMENSIONS in millimeters



PACKAGE MARKING (example)

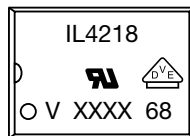

Fig. 8 - Example of IL4218-X017T

Notes

- XXXX = LMC (lot marking code)
- VDE logo is only marked on option 1 parts
- Tape and reel suffix (T) is not part of the package marking



SOLDER PROFILES

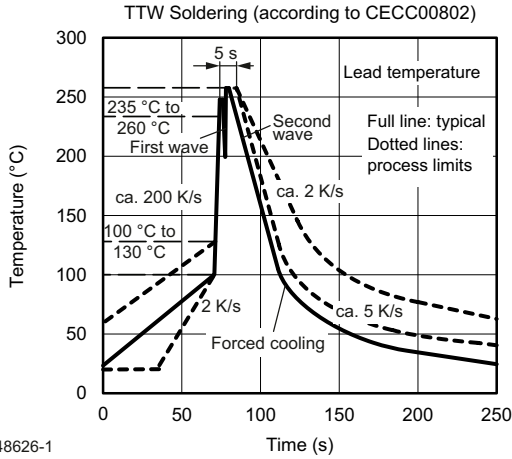

948626-1

Fig. 9 - Wave Soldering Double Wave Profile According to J-STD-020 for DIP Devices

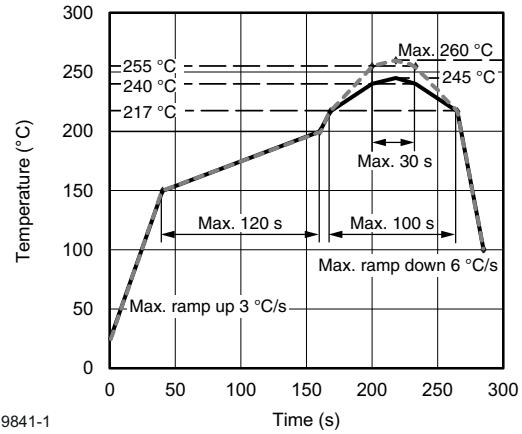

19841-1

Fig. 10 - Lead (Pb)-free Reflow Solder Profile According to J-STD-020 for SMD Devices

HANDLING AND STORAGE CONDITIONS

ESD level: HBM class 2

Floor life: unlimited

Conditions: $T_{amb} < 30\text{ }^{\circ}\text{C}$, RH < 85 %

Moisture sensitivity level 1, according to J-STD-020



Disclaimer

ALL PRODUCT, PRODUCT SPECIFICATIONS AND DATA ARE SUBJECT TO CHANGE WITHOUT NOTICE TO IMPROVE RELIABILITY, FUNCTION OR DESIGN OR OTHERWISE.

Vishay Intertechnology, Inc., its affiliates, agents, and employees, and all persons acting on its or their behalf (collectively, "Vishay"), disclaim any and all liability for any errors, inaccuracies or incompleteness contained in any datasheet or in any other disclosure relating to any product.

Vishay makes no warranty, representation or guarantee regarding the suitability of the products for any particular purpose or the continuing production of any product. To the maximum extent permitted by applicable law, Vishay disclaims (i) any and all liability arising out of the application or use of any product, (ii) any and all liability, including without limitation special, consequential or incidental damages, and (iii) any and all implied warranties, including warranties of fitness for particular purpose, non-infringement and merchantability.

Statements regarding the suitability of products for certain types of applications are based on Vishay's knowledge of typical requirements that are often placed on Vishay products in generic applications. Such statements are not binding statements about the suitability of products for a particular application. It is the customer's responsibility to validate that a particular product with the properties described in the product specification is suitable for use in a particular application. Parameters provided in datasheets and / or specifications may vary in different applications and performance may vary over time. All operating parameters, including typical parameters, must be validated for each customer application by the customer's technical experts. Product specifications do not expand or otherwise modify Vishay's terms and conditions of purchase, including but not limited to the warranty expressed therein.

Hyperlinks included in this datasheet may direct users to third-party websites. These links are provided as a convenience and for informational purposes only. Inclusion of these hyperlinks does not constitute an endorsement or an approval by Vishay of any of the products, services or opinions of the corporation, organization or individual associated with the third-party website. Vishay disclaims any and all liability and bears no responsibility for the accuracy, legality or content of the third-party website or for that of subsequent links.

Vishay products are not designed for use in life-saving or life-sustaining applications or any application in which the failure of the Vishay product could result in personal injury or death unless specifically qualified in writing by Vishay. Customers using or selling Vishay products not expressly indicated for use in such applications do so at their own risk. Please contact authorized Vishay personnel to obtain written terms and conditions regarding products designed for such applications.

No license, express or implied, by estoppel or otherwise, to any intellectual property rights is granted by this document or by any conduct of Vishay. Product names and markings noted herein may be trademarks of their respective owners.

OUR CERTIFICATE

DiGi provide top-quality products and perfect service for customer worldwide through standardization, technological innovation and continuous improvement. DiGi through third-party certification, we stricly control the quality of products and services. Welcome your RFQ to

Email: Info@DiGi-Electronics.com



Tel: +00 852-30501935

RFQ Email: Info@DiGi-Electronics.com

DiGi is a global authorized distributor of electronic components.