

# 032603.2HXP Datasheet



DiGi Electronics Part Number	032603.2HXP-DG
Manufacturer	<a href="#">Littelfuse Inc.</a>
Manufacturer Product Number	032603.2HXP
Description	FUSE CERAMIC 3.2A 250VAC 3AB 3AG
Detailed Description	3.2 A 250 V AC DC Fuse Cartridge, Ceramic Requires Holder 3AB, 3AG, 1/4" x 1-1/4"

<https://www.DiGi-Electronics.com>

This model 032603.2HXP is available at DiGi Electronics.

DiGi Electronics offers a global database of semiconductor and electronic component datasheets.

We welcome your inquiries regarding pricing, lead time, or other product-related questions.

 [Request a Quote](#)

 [Datasheet Search](#)



Tel: +00 852-30501935

RFQ Email: [Info@DiGi-Electronics.com](mailto:Info@DiGi-Electronics.com)

DiGi is a global authorized distributor of electronic components.

## Purchase and inquiry

Manufacturer Product Number:

032603.2HXP

Series:

326

Mounting Type:

Requires Holder

Current Rating (Amps):

3.2 A

Response Time:

Slow Blow

Breaking Capacity @ Rated Voltage:

100A

Approval Agency:

CE, CSA, K-MARK, PSE, UL

Color:

-

DC Cold Resistance:

0.0539 Ohms

Manufacturer:

Littelfuse Inc.

Product Status:

Active

Fuse Type:

Cartridge, Ceramic

Voltage Rating - AC:

250 V

Package / Case:

3AB, 3AG, 1/4" x 1-1/4"

Melting I<sup>2</sup>t:

214

Operating Temperature:

-55°C ~ 125°C

Size / Dimension:

0.250" Dia x 1.250" L (6.35mm x 31.75mm)

## Environmental & Export classification

RoHS Status:

ROHS3 Compliant

REACH Status:

REACH Unaffected

HTSUS:

8536.10.0040

Moisture Sensitivity Level (MSL):

1 (Unlimited)







ECCN:

EAR99

## 325/326 Series Lead-Free 3AB, Slo-Blo® Fuse



### Agency Approvals

Agency	Agency File Number	Ampere Range
	E10480	0.250A - 10A
	E10480	12A - 30A
	29862	0.250A - 30A
	Cartridge: NBK 030805-E10480A NBK 030805-E10480C NBK 030805-E10480E NBK 260106-JP1021A Leaded: NBK 030805-E10480B NBK 030805-E10480D NBK 030805-E10480F NBK 260106-JP1021B	1A-3.2A 4A-5A 6.25A-15A 20A-30A 1A-3.2A 4A-5A 6.25A-15A 20A-30A
	SU05001-5010 SU05001-5011 SU05001-5012 SU05001-6006 SU05001-6007	7-10A 12A, 15A 20A 2.8A-3.2A 2.5A
	T 50239752 01	*12A/*15A/*20A
	N/A	0.010A - 30A

\* Approved for cartridge version only

### Description

The 3AB Slo-Blo® Fuse with ceramic body construction permits higher interrupting ratings and voltage ratings. Ideal for applications where high current loads are expected.

### Features

- In accordance with UL Standard 248-14
- Available in cartridge and axial lead format and with various forming dimensions
- RoHS compliant and Lead-free

### Applications

Used as supplementary protection in appliance or utilization equipment to provide individual protection for components or internal circuits.

### Electrical Characteristics for Series

% of Ampere Rating	Ampere Rating	Opening Time
100%	0.010A – 30A	4 hours, Minimum
135%	0.010A – 30A	1 hour, Maximum
200%	0.010A – 3.2A	5 sec., Min., 30 sec., Max.
	4A – 30A	5 sec., Min., 60 sec., Max.

### Additional Information



**Datasheet**  
325 Series



**Resources**  
325 Series



**Samples**  
325 Series



**Accessories**  
325 Series



**Datasheet**  
326 Series



**Resources**  
326 Series



**Samples**  
326 Series



**Accessories**  
326 Series

For recommended fuse accessories for this product series, see '[Recommended Accessories](#)' section.

**Electrical Characteristic Specifications by Item**

Amp Code	Ampere Rating (A)	Voltage Rating (V)	Interrupting Rating	Nominal Cold Resistance (Ohms)	Nominal Melting I <sup>2</sup> t (A <sup>2</sup> sec)	Agency Approvals						
												
.010	0.01	250	100A@250Vac	3324.8000	0.00013					x		
.031	0.031	250		332.5000	0.0110					x		
.062	0.062	250		91.7000	0.0276					x		
.100	0.1	250		33.5500	0.0870					x		
.125	0.125	250		22.4500	0.100					x		
.150	0.15	250		15.4500	0.143					x		
.175	0.175	250		8.9200	0.350					x		
.187	0.187	250		7.7250	0.330					x		
.200	0.2	250		6.7700	0.316					x		
.250	0.25	250		4.4300	0.804			x	x	x		
.300	0.3	250	3.2200	1.230			x	x	x			
.375	0.375	250	2.1550	1.20			x	x	x			
.400	0.4	250	1.9350	1.33			x	x	x			
.500	0.5	250	1.3000	4.80			x	x	x			
.600	0.6	250	0.9495	3.90			x	x	x			
.700	0.7	250	0.7215	6.42			x	x	x			
.750	0.75	250	0.6410	13.00			x	x	x			
.800	0.8	250	0.5725	8.20			x	x	x			
001.	1	250	10KA@125Vac 10KA@125Vdc	0.3890	16.3	x		x	x	x		
01.2	1.2	250		0.2860	22.0	x		x	x	x		
1.25	1.25	250		0.2680	40.0	x		x	x	x		
01.5	1.5	250		0.1975	59.7	x		x	x	x		
01.6	1.6	250		0.1760	66.0	x		x	x	x		
002.	2	250		0.1210	118.0	x		x	x	x		
02.5	2.5	250		0.0835	185.0	x		x	x	x		x
02.8	2.8	250		0.0695	232.0	x		x	x	x		x
003.	3	250		0.0605	200.0	x		x	x	x		x
03.2	3.2	250	100A@250Vac 10KA@125Vac	0.0539	214.0	x		x	x	x		x
004.	4	250	400A@250Vac 10KA@125Vac 10KA@125Vdc	0.0761	9.71	x		x	x	x		
005.	5	250		0.0522	25.0	x		x	x	x		
6.25	6.25	250		0.0346	60.4	x		x	x	x		
007.	7	250		0.0227	47.3	x		x	x	x		x
008.	8	250		0.0193	67.1	x		x	x	x		x
010.	10	250		0.0132	137	x		x	x	x		x
012.	12	250	400A@250Vac 10KA@125Vac 600A@125Vdc	0.0067	129	x	x	x		x	x***	x
012.*	12	250	1500A@250Vac	0.0011	618		x	x		x		
015.	15	250	400A@250Vac 10KA@125Vac 600A@125Vdc	0.0050	245	x	x	x		x	x***	x
015.*	15	250	1500A@250Vac	0.0083	760		x	x		x		
020.	20	250	400A@250Vac 10KA@125Vac 600A@125Vdc	0.0034	575	x	x	x		x	x***	x
020.*	20	250	1500A@250Vac	0.0042	2500		x	x		x		
025.**	25	250	1500A@250Vac	0.0032	4682		x			x		
025.	25	250	400A@250Vac 10KA@60Vdc	0.0024	1030	x	x	x		x		
030.	30	250	600A@125Vdc	0.0019	1690	x	x	x		x		

\*Higher I<sup>2</sup>t version available. Please add suffix "D" to part numbers. For instance, 0325020.MXDP, 0326020.MXDP  
 I<sup>2</sup>t test at 10x rated current.

\*\*Higher I<sup>2</sup>t version available. Please add suffix "W" to part numbers. For instance, 0325025.MXWP

\*\*\*Approved for cartridge versions only, and interrupting rating is 400A@125Vac and 400A@250Vac

**Temperature Re-rating Curve**



Note:  
Rerating depicted in this curve is in addition to the standard derating of 25% for continuous operation.

**Average Time Current Curves**



**Soldering Parameters - Wave Soldering**

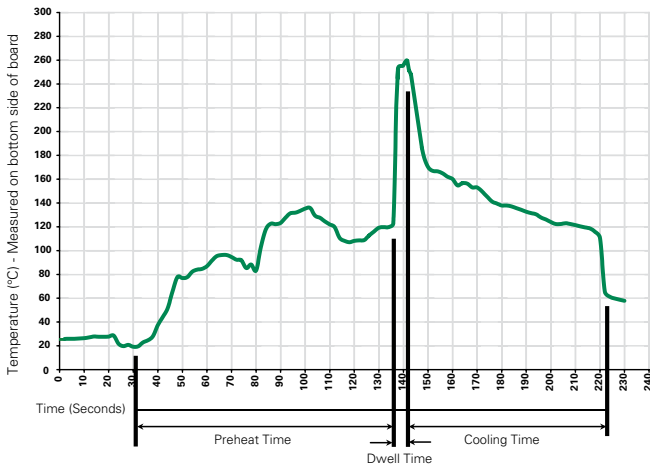

**Recommended Process Parameters:**

Wave Parameter	Lead-Free Recommendation
Preheat: (Depends on Flux Activation Temperature)	(Typical Industry Recommendation)
Temperature Minimum:	100°C
Temperature Maximum:	150°C
Preheat Time:	60-180 seconds
Solder Pot Temperature:	260°C Maximum
Solder Dwell Time:	2-5 seconds

**Recommended Hand-Solder Parameters:**

Solder Iron Temperature: 350°C +/- 5°C  
Heating Time: 5 seconds max.

**Note: These devices are not recommended for IR or Convection Reflow process.**

### Product Characteristics

<b>Materials</b>	Body: Ceramic Cap: Nickel-plated brass Leads: Tin-plated Copper
<b>Terminal Strength</b>	MIL-STD-202, Method 211, Test Condition A
<b>Solderability</b>	MIL-STD-202 Method 208
<b>Product Marking</b>	Cap1: Brand logo, current and voltage ratings Cap2: Series and agency approval marks

<b>Operating Temperature</b>	-55°C to +125°C
<b>Thermal Shock</b>	MIL-STD-202, Method 107, Test Condition B: (5 cycles - 65°C to 125°C)
<b>Vibration:</b>	MIL-STD-202, Method 201
<b>Humidity</b>	MIL-STD-202, Method 103, Test Condition A: High RH (95%) and Elevated temperature (40°C) for 240 hours
<b>Salt Spray</b>	MIL-STD-202, Method 101, Test Condition B

### Dimensions

Measurements displayed in millimeters (inches)

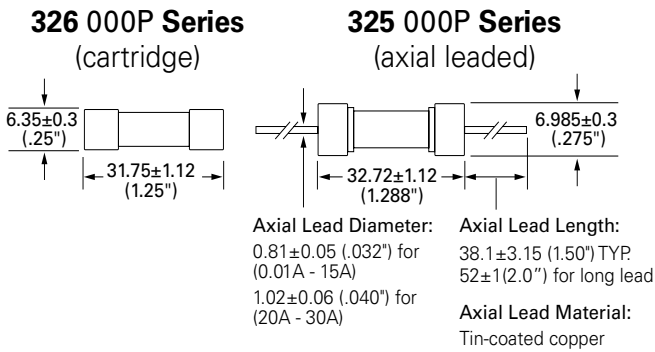

### Part Numbering System

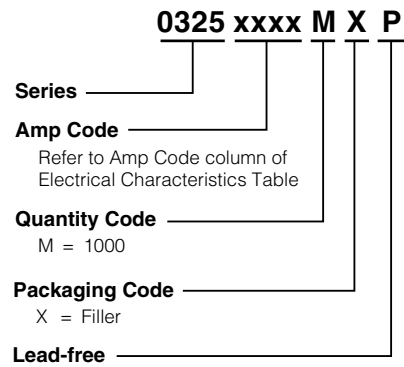

### Packaging

Packaging Option	Packaging Specification	Quantity	Quantity & Packaging Code	Taping Width
<b>325 Series</b>				
Bulk	N/A	5	VX	N/A
Bulk	N/A	100	HX	N/A
Bulk	N/A	1000	MX	N/A
Bulk	N/A	1000	MX52 (long lead)	N/A
Bulk	N/A	1000	MX52L (long lead)	N/A
Bulk	N/A	1000	MXD	N/A
Bulk	N/A	1000	MXF31	N/A
Bulk	N/A	1000	MXW	N/A
<b>326 Series</b>				
Bulk	N/A	5	VX	N/A
Bulk	N/A	100	HX	N/A
Bulk	N/A	1000	MX	N/A
Bulk	N/A	1000	MXCC	N/A
Bulk	N/A	1000	MXD	N/A

### Recommended Accessories

Accessory Type	Series	Description	Max Application Voltage	Max Application Amperage
Holder	<a href="#">155100</a>	Twist-Lock In-Line Fuseholder	32	20
	<a href="#">342</a>	Traditional Panel Mount Fuseholder	250	20
	<a href="#">346</a>	Panel Mount Flip-Top Shock-Safe Fuseholder	250	15
	<a href="#">345</a>	Shock-Safe Fuseholder with PC Mount, Solder Mount and Panel Mount options	250	20
Block	<a href="#">354</a>	Low Profile OMNI-BLOK® Fuse Block	600	30
	<a href="#">359</a>	High Current Screw Terminal Fuse Block		30
Clip	<a href="#">122</a>	High Current Traditional PC Board Fuse Clip	1000	30
	<a href="#">101</a>	Rivet/Eyelet Type Fuse Clip	1000	15

Notes:

1. Do not use in applications above rating.
2. Please refer to fuseholder data sheet for specific re-rating information.
3. Please contact Littelfuse for applications greater than the max voltage and amperage shown.

**Disclaimer Notice** - Information furnished is believed to be accurate and reliable. However, users should independently evaluate the suitability of and test each product selected for their own applications. Littelfuse products are not designed for, and may not be used in, all applications. Read complete Disclaimer Notice at: [www.littelfuse.com/disclaimer-electronics](http://www.littelfuse.com/disclaimer-electronics).

## OUR CERTIFICATE

DiGi provide top-quality products and perfect service for customer worldwide through standardization, technological innovation and continuous improvement. DiGi through third-party certification, we stricly control the quality of products and services. Welcome your RFQ to

Email: [Info@DiGi-Electronics.com](mailto:Info@DiGi-Electronics.com)



Tel: +00 852-30501935

RFQ Email: [Info@DiGi-Electronics.com](mailto:Info@DiGi-Electronics.com)

DiGi is a global authorized distributor of electronic components.