

15KPA75CA Datasheet



www.digi-electronics.com

<https://www.DiGi-Electronics.com>

DiGi Electronics Part Number	15KPA75CA-DG
Manufacturer	Littelfuse Inc.
Manufacturer Product Number	15KPA75CA
Description	TVS DIODE 75VWM 122VC P600
Detailed Description	122V Clamp 123.8A Ipp Tvs Diode Through Hole P600

This model 15KPA75CA is available at DiGi Electronics.

DiGi Electronics offers a global database of semiconductor and electronic component datasheets.

We welcome your inquiries regarding pricing, lead time, or other product-related questions.

 [Request a Quote](#)

 [Datasheet Search](#)



Tel: +00 852-30501935

RFQ Email: Info@DiGi-Electronics.com

DiGi is a global authorized distributor of electronic components.

Purchase and inquiry

Manufacturer Product Number:

15KPA75CA

Series:

15KPA

Type:

Zener

Voltage - Reverse Standoff (Typ):

75V

Voltage - Clamping (Max) @ Ipp:

122V

Power - Peak Pulse:

15000W (15kW)

Applications:

General Purpose

Operating Temperature:

-55°C ~ 175°C (Tj)

Package / Case:

P600, Axial

Base Product Number:

15KPA

Manufacturer:

Littelfuse Inc.

Product Status:

Active

Bidirectional Channels:

1

Voltage - Breakdown (Min):

83.8V

Current - Peak Pulse (10/1000µs):

123.8A

Power Line Protection:

No

Capacitance @ Frequency:

-

Mounting Type:

Through Hole

Supplier Device Package:

P600

Environmental & Export classification

RoHS Status:

ROHS3 Compliant

REACH Status:

REACH Unaffected

HTSUS:

8541.10.0080

Moisture Sensitivity Level (MSL):

Not Applicable

ECCN:

EAR99

15KPA Series

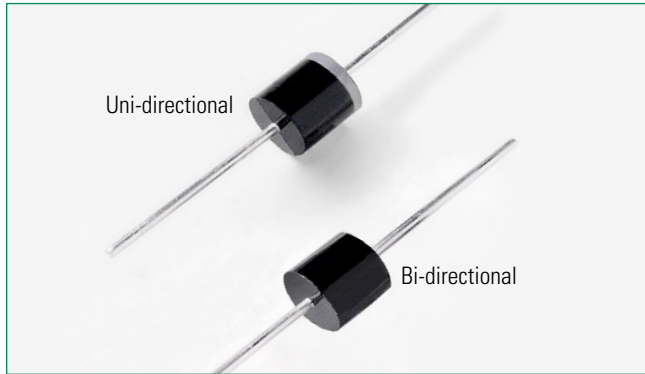

Agency Approvals

Agency	Agency File Number
	E230531

Maximum Ratings and Thermal Characteristics (T_A = 25°C unless otherwise noted)

Parameter	Symbol	Value	Unit
Peak Pulse Power Dissipation by 10/1000µs Test Waveform (Fig.2)(Note 1)	P _{PPM}	15	kW
Steady State Power Dissipation on Infinite Heat Sink at T _L = 75°C	P _D	8.0	W
Peak Forward Surge Current, 8.3ms Single Half Sine Wave Unidirectional Only (Note 2)	I _{FSM}	400	A
Operating Junction and Storage Temperature Range	T _J , T _{STG}	-55 to 175	°C
Typical Thermal Resistance Junction to Lead	R _{θJL}	8.0	°C/W
Typical Thermal Resistance Junction to Ambient	R _{θJA}	40	°C/W

Notes:

1. Non-repetitive current pulse, per Fig. 4 and derated above T_J (initial) = 25°C per Fig. 3.
2. Measured on 8.3ms single half sine wave or equivalent square wave, duty cycle=4 per minute maximum.

Descriptions

The 15KPA Series is designed specifically to protect sensitive electronic equipment from voltage transients induced by lightning and other transient voltage events.

Features

- Glass passivated chip junction in P600 package
- 15kW peak pulse capability at 10/1000µs waveform, repetition rate (duty cycles):0.01 %
- Fast response time: typically less than 1.0ps from 0 Volts to BV min
- Excellent clamping capability
- Typical failure mode is short from over-specified voltage or current
- Whisker test is conducted based on JEDEC JESD201A per its table 4a and 4c
- IEC 61000-4-2 ESD 30kV(Air), 30kV (Contact)
- ESD protection of data lines in accordance with IEC 61000-4-2
- EFT protection of data lines in accordance with IEC 61000-4-4
- Low incremental surge resistance
- Typical I_R less than 2µA when V_{BR} min>36V
- High temperature to reflow soldering guaranteed: 260°C/40sec / 0.375", (9.5mm) lead length, 5 lbs., (2.3kg) tension
- V_{BR} @ T_J = V_{BR} @ 25°C x (1 + α T x (T_J - 25)) (α T: Temperature Coefficient, typical value is 0.1%)
- UL Recognized compound meeting flammability rating V-0
- Matte tin lead-free plated
- Halogen free and RoHS compliant
- Pb-free E3 means 2nd level interconnect is Pb-free and the terminal finish material is tin(Sn) (IPC/ JEDEC J-STD-609A.01)
- Recognized to UL 497B

Applications

TVS components are ideal for the protection of I/O interfaces, V_{CC} bus and other vulnerable circuits used in telecom, computer, industrial and consumer electronic applications.

Additional Information



Datasheet



Resources



Samples

Functional Diagram

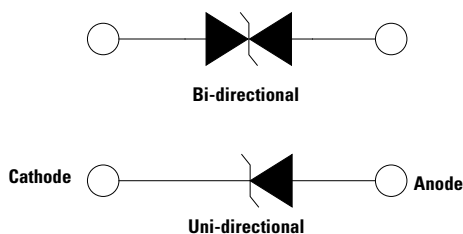

TVS Diode

Axial Leaded – 15000W > 15KPA series

Electrical Characteristics (T_A=25°C unless otherwise noted)

Part Number (Uni)	Part Number (Bi)	Reverse Stand off Voltage V _R (Volts)	Breakdown Voltage V _{BR} (Volts) @ I _T		Test Current I _T (mA)	Maximum Peak Pulse Current I _{PP} (A)	Maximum Reverse Leakage I _R @ V _R (μA)	Maximum Clamping Voltage V _C @ I _{PP} (V)	Agency Recognition 
			MIN	MAX					
15KPA17A	15KPA17CA	17	18.99	20.79	50	515.4	5000	29.3	X
15KPA18A	15KPA18CA	18	20.11	22.01	50	488.7	5000	30.9	X
15KPA20A	15KPA20CA	20	22.34	24.46	20	440.2	1500	34.3	X
15KPA22A	15KPA22CA	22	24.57	26.91	10	407.0	500	37.1	X
15KPA24A	15KPA24CA	24	26.81	29.35	5	371.0	150	40.7	X
15KPA26A	15KPA26CA	26	29.04	31.80	5	343.2	50	44.0	X
15KPA28A	15KPA28CA	28	31.28	34.24	5	317.9	25	47.5	X
15KPA30A	15KPA30CA	30	33.51	36.70	5	297.8	15	50.7	X
15KPA33A	15KPA33CA	33	36.9	40.4	5	276.1	2	54.7	X
15KPA36A	15KPA36CA	36	40.2	44.0	5	252.5	2	59.8	X
15KPA40A	15KPA40CA	40	44.7	48.9	5	229.5	2	65.8	X
15KPA43A	15KPA43CA	43	48.0	52.6	5	216.3	2	69.8	X
15KPA45A	15KPA45CA	45	50.3	55.0	5	207.4	2	72.8	X
15KPA48A	15KPA48CA	48	53.6	58.7	5	194.3	2	77.7	X
15KPA51A	15KPA51CA	51	57.0	62.4	5	182.1	2	82.9	X
15KPA54A	15KPA54CA	54	60.3	66.0	5	172.2	2	87.7	X
15KPA58A	15KPA58CA	58	64.8	70.9	5	161.0	2	93.8	X
15KPA60A	15KPA60CA	60	67.0	73.4	5	155.0	2	97.4	X
15KPA64A	15KPA64CA	64	71.5	78.3	5	144.9	2	104.2	X
15KPA70A	15KPA70CA	70	78.2	85.6	5	132.9	2	113.6	X
15KPA75A	15KPA75CA	75	83.8	91.7	5	123.8	2	122.0	X
15KPA78A	15KPA78CA	78	87.1	95.4	5	119.7	2	126.1	X
15KPA85A	15KPA85CA	85	94.9	104.0	5	109.7	2	137.6	X
15KPA90A	15KPA90CA	90	100.5	110.1	5	103.7	2	145.6	X
15KPA100A	15KPA100CA	100	111.7	122.3	5	93.6	2	161.3	X
15KPA110A	15KPA110CA	110	122.9	134.5	5	84.5	2	178.6	X
15KPA120A	15KPA120CA	120	134.0	146.8	5	78.5	2	192.3	X
15KPA130A	15KPA130CA	130	145.2	159.0	5	72.5	2	208.3	X
15KPA150A	15KPA150CA	150	167.6	183.5	5	62.4	2	241.9	X
15KPA160A	15KPA160CA	160	178.7	195.7	5	58.4	2	258.6	X
15KPA170A	15KPA170CA	170	189.9	207.9	5	55.4	2	272.7	X
15KPA180A	15KPA180CA	180	201.1	220.1	5	52.3	2	288.5	X
15KPA200A	15KPA200CA	200	223.4	244.6	5	47.3	2	319.1	X
15KPA220A	15KPA220CA	220	245.7	269.1	5	42.4	2	356.0	X
15KPA240A	15KPA240CA	240	268.1	293.5	5	39.3	2	384.6	X
15KPA260A	15KPA260CA	260	290.4	318.0	5	36.2	2	416.7	X
15KPA280A	15KPA280CA	280	312.8	342.4	5	33.2	2	454.5	X

For bidirectional type having V_R of 30 volts and less, the I_R limit is double.

For parts without A, the V_{BR} is ±10% and V_C is 5% higher than with A parts, the parts without A are currently available, but not recommended for new designs. The parts with A are preferred.

I-V Curve Characteristics

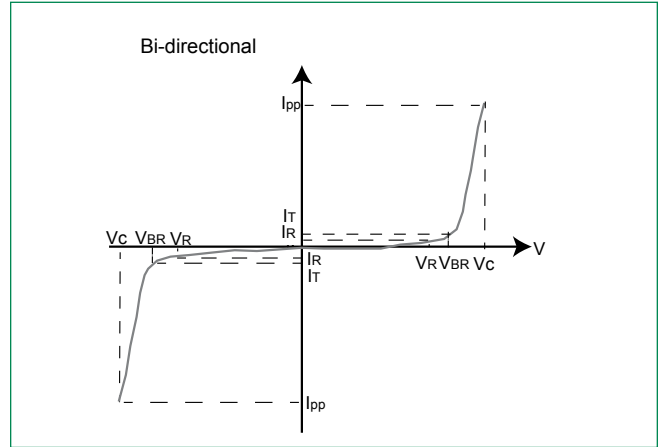
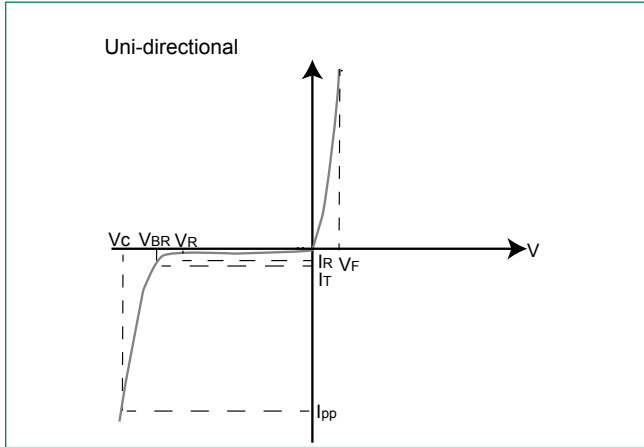

- P_{PPM} Peak Pulse Power Dissipation** – Max power dissipation
- V_R Stand-off Voltage** – Maximum voltage that can be applied to the TVS without operation
- V_{BR} Breakdown Voltage** – Maximum voltage that flows through the TVS at a specified test current (I_T)
- V_C Clamping Voltage** – Peak voltage measured across the TVS at a specified I_{ppm} (peak impulse current)
- I_R Reverse Leakage Current** – Current measured at V_R
- V_F Forward Voltage Drop for Uni-directional**

Ratings and Characteristic Curves ($T_A=25^\circ\text{C}$ unless otherwise noted)

Figure 1 - TVS Transients Clamping Waveform

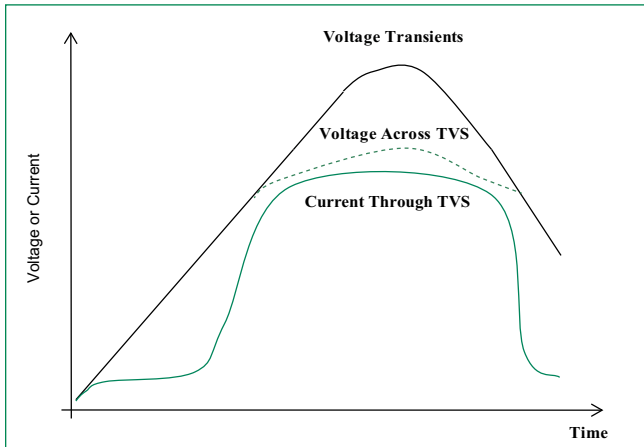
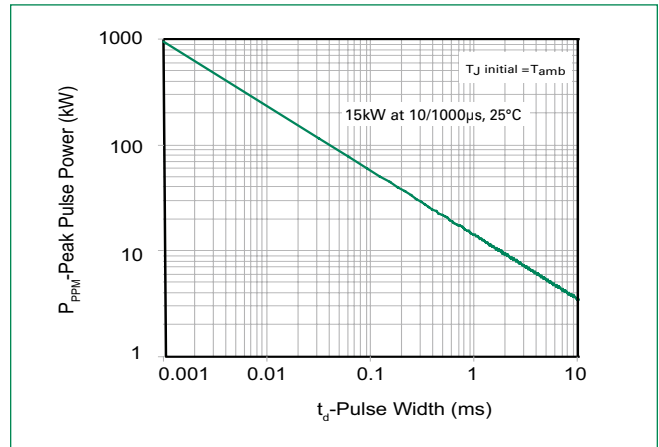

Figure 2 - Peak Pulse Power Rating Curve



Ratings and Characteristic Curves ($T_A=25^\circ\text{C}$ unless otherwise noted) (Continued)

Figure 3 - Peak Pulse Power Derating Curve

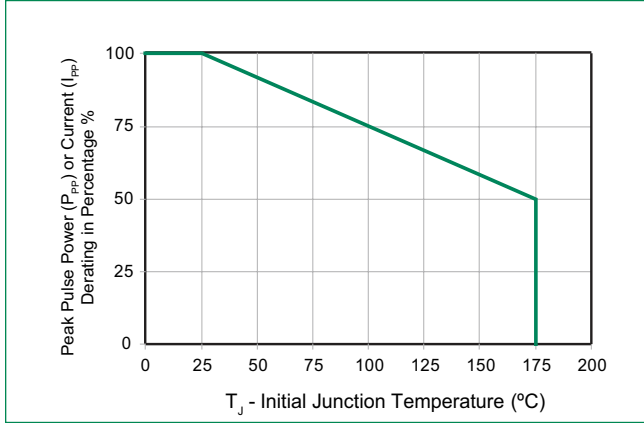

Figure 4 - Test Pulse Waveform

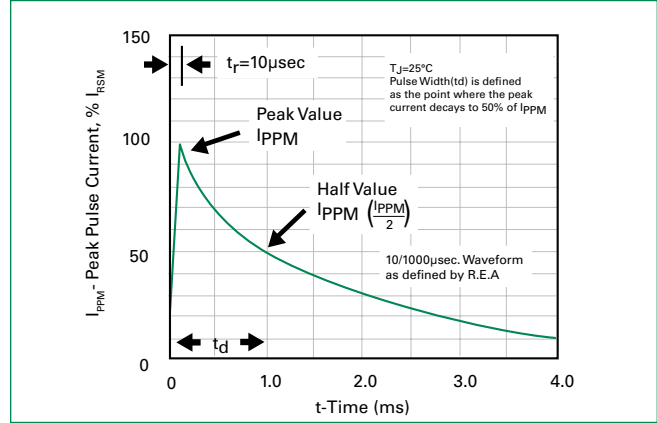

Figure 5 - Typical Junction Capacitance

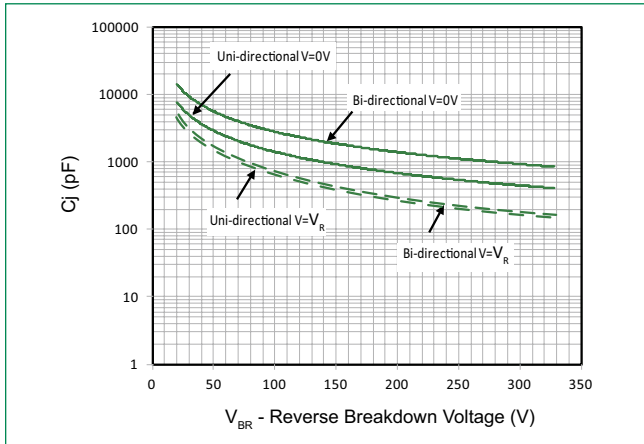

Figure 6 - Typical Transient Thermal Impedance

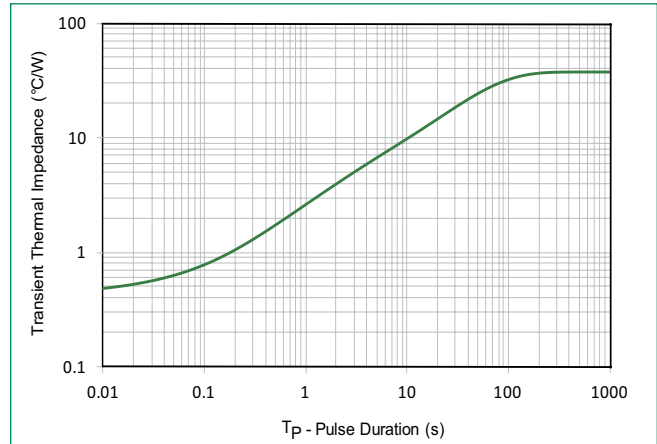

Figure 7 - Maximum Non-Repetitive Peak Forward Surge Current Uni-Directional Only

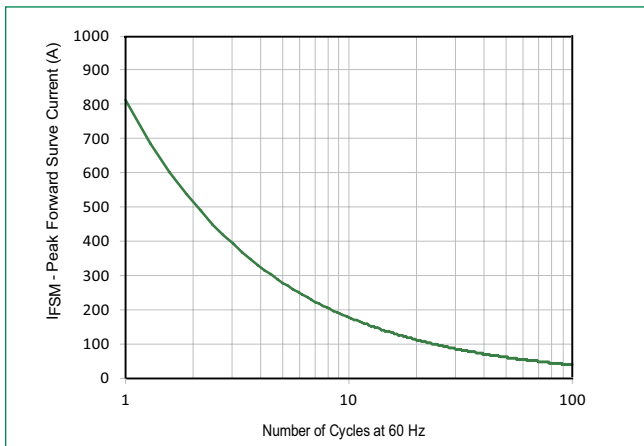
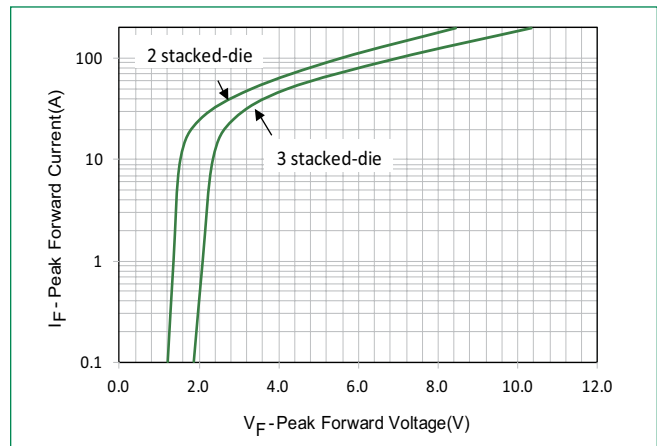
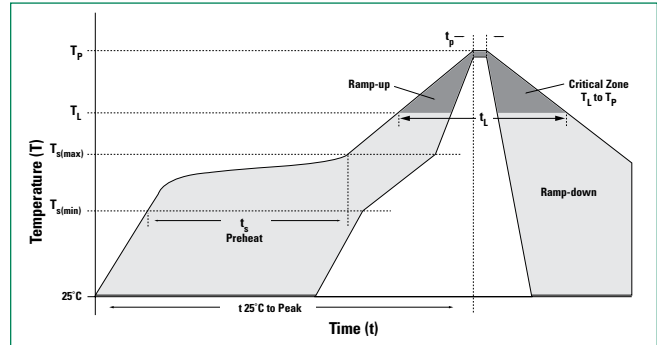

Figure 8 - Peak Forward Voltage Drop vs Peak Forward Current (Typical Values)



Soldering Parameters

Reflow Condition		Lead-free assembly
Pre Heat	- Temperature Min ($T_{s(min)}$)	150°C
	- Temperature Max ($T_{s(max)}$)	200°C
	- Time (min to max) (t_s)	60 – 180 secs
Average ramp up rate (Liquidus Temp (T_A) to peak)		3°C/second max
$T_{s(max)}$ to T_A - Ramp-up Rate		3°C/second max
Reflow	- Temperature (T_A) (Liquidus)	217°C
	- Time (min to max) (t_s)	60 – 150 seconds
Peak Temperature (T_p)		260 ^{+0/-5} °C
Time within 5°C of actual peak Temperature (t_p)		20 – 40 seconds
Ramp-down Rate		6°C/second max
Time 25°C to peak Temperature (T_p)		8 minutes Max.
Do not exceed		260°C



Flow/Wave Soldering (Solder Dipping)

Peak Temperature :	265°C
Dipping Time :	10 seconds
Soldering :	1 time

Physical Specifications

Weight	0.07oz., 2.5g
Case	P600 molded plastic body over passivated junction.
Polarity	Color band denotes the cathode except Bipolar.
Terminal	Matte Tin axial leads, solderable per JESD22-B102.

Environmental Specifications

High Temp. Storage	JESD22-A103
HTRB	JESD22-A108
Temperature Cycling	JESD22-A104
H3TRB	JESD22-A101
RSH	JESD22-B106

Dimensions

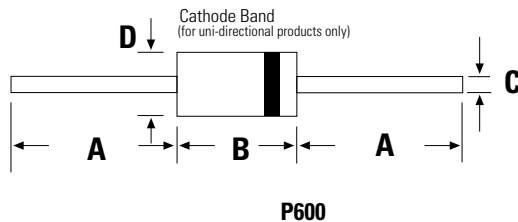

Dimensions	Inches		Millimeters	
	Min	Max	Min	Max
A	1.000	-	25.40	-
B	0.340	0.360	8.60	9.10
C	0.048	0.054	1.22	1.36
D	0.340	0.360	8.60	9.10

Part Numbering System

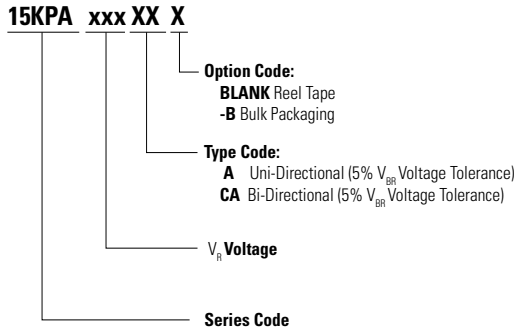

Part Marking System

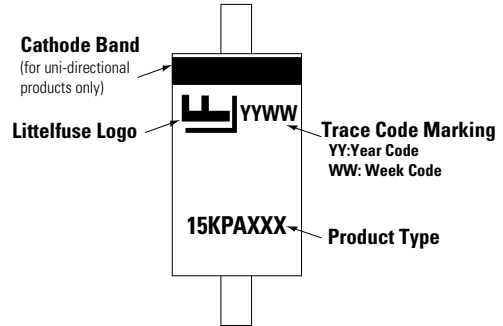

Packing Options

Part Number	Component Package	Quantity	Packaging Option	Packaging Specification
15KPAxxxXX	P600	800	Tape & Reel	EIA STD RS-296
15KPAxxxXX-B	P600	100	Bulk	Littelfuse Spec.

Tape and Reel Specification

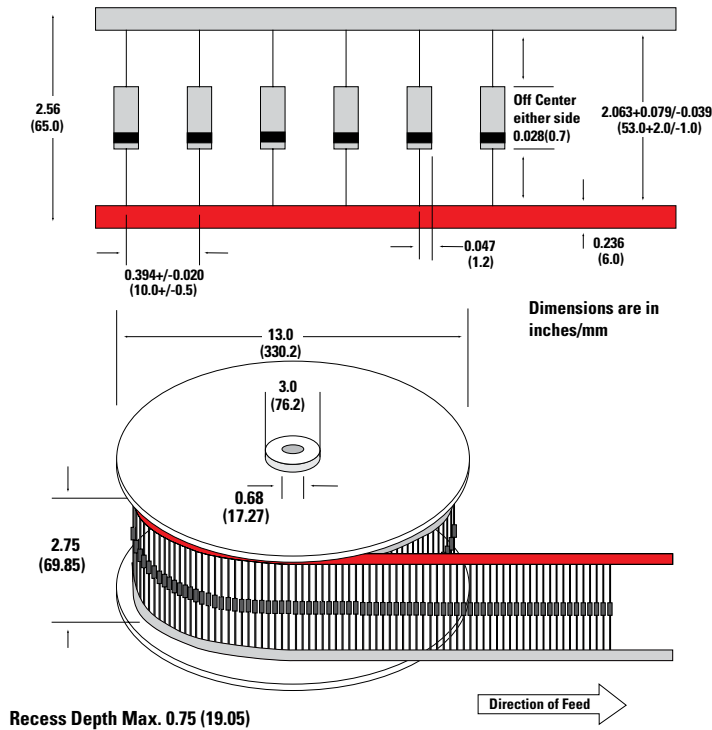

OUR CERTIFICATE

DiGi provide top-quality products and perfect service for customer worldwide through standardization, technological innovation and continuous improvement. DiGi through third-party certification, we stricly control the quality of products and services. Welcome your RFQ to

Email: Info@DiGi-Electronics.com



Tel: +00 852-30501935

RFQ Email: Info@DiGi-Electronics.com

DiGi is a global authorized distributor of electronic components.