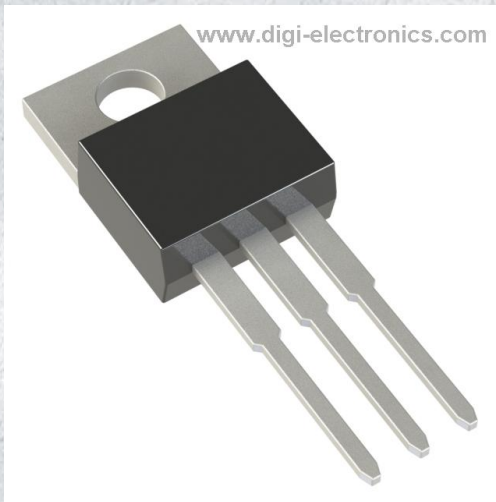


# IXTP3N50P Datasheet



<https://www.DiGi-Electronics.com>

DiGi Electronics Part Number	IXTP3N50P-DG
Manufacturer	<a href="#">IXYS</a>
Manufacturer Product Number	IXTP3N50P
Description	MOSFET N-CH 500V 3.6A TO220AB
Detailed Description	N-Channel 500 V 3.6A (Tc) 70W (Tc) Through Hole T O-220-3



Tel: +00 852-30501935

RFQ Email: [Info@DiGi-Electronics.com](mailto:Info@DiGi-Electronics.com)

DiGi is a global authorized distributor of electronic components.

## Purchase and inquiry

Manufacturer Product Number:

IXTP3N50P

Series:

PolarHV™

FET Type:

N-Channel

Drain to Source Voltage (Vdss):

500 V

Drive Voltage (Max Rds On, Min Rds On):

10V

Vgs(th) (Max) @ Id:

5.5V @ 50µA

Vgs (Max):

±30V

FET Feature:

-

Operating Temperature:

-55°C ~ 150°C (Tj)

Supplier Device Package:

TO-220-3

Base Product Number:

IXTP3

Manufacturer:

IXYS

Product Status:

Obsolete

Technology:

MOSFET (Metal Oxide)

Current - Continuous Drain (Id) @ 25°C:

3.6A (Tc)

Rds On (Max) @ Id, Vgs:

20hm @ 1.8A, 10V

Gate Charge (Qg) (Max) @ Vgs:

9.3 nC @ 10 V

Input Capacitance (Ciss) (Max) @ Vds:

409 pF @ 25 V

Power Dissipation (Max):

70W (Tc)

Mounting Type:

Through Hole

Package / Case:

TO-220-3

## Environmental & Export classification

Moisture Sensitivity Level (MSL):

1 (Unlimited)

ECCN:

EAR99

REACH Status:

REACH Unaffected

HTSUS:

8541.29.0095

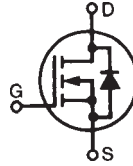


# Polar™ Power MOSFET

## IXTY3N50P IXTA3N50P IXTP3N50P

$$\begin{aligned} V_{DSS} &= 500V \\ I_{D25} &= 3A \\ R_{DS(on)} &\leq 2\Omega \end{aligned}$$

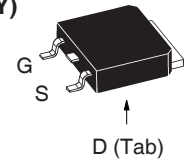
N-Channel Enhancement Mode  
Avalanche Rated



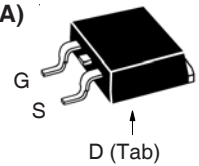
Symbol	Test Conditions	Maximum Ratings	
$V_{DSS}$	$T_J = 25^\circ\text{C}$ to $150^\circ\text{C}$	500	V
$V_{DGR}$	$T_J = 25^\circ\text{C}$ to $150^\circ\text{C}$ , $R_{GS} = 1M\Omega$	500	V
$V_{GSS}$	Continuous	$\pm 30$	V
$V_{GSM}$	Transient	$\pm 40$	V
$I_{D25}$	$T_C = 25^\circ\text{C}$	3	A
$I_{DM}$	$T_C = 25^\circ\text{C}$ , Pulse Width Limited by $T_{JM}$	8	A
$I_A$	$T_C = 25^\circ\text{C}$	3	A
$E_{AS}$	$T_C = 25^\circ\text{C}$	180	mJ
$dv/dt$	$I_S \leq I_{DM}$ , $V_{DD} \leq V_{DSS}$ , $T_J \leq 150^\circ\text{C}$	10	V/ns
$P_D$	$T_C = 25^\circ\text{C}$	70	W
$T_J$		-55 ... +150	$^\circ\text{C}$
$T_{JM}$		150	$^\circ\text{C}$
$T_{stg}$		-55 ... +150	$^\circ\text{C}$
$T_L$	Maximum Lead Temperature for Soldering	300	$^\circ\text{C}$
$T_{SOLD}$	1.6 mm (0.062in.) from Case for 10s	260	$^\circ\text{C}$
$F_C$	Mounting Force (TO-263)	10..65 / 2.2..14.6	N/lb
$M_d$	Mounting Torque (TO-220)	1.13 / 10	Nm/lb.in
<b>Weight</b>	TO-252	0.35	g
	TO-263	2.50	g
	TO-220	3.00	g

Symbol	Test Conditions ( $T_J = 25^\circ\text{C}$ , Unless Otherwise Specified)	Characteristic Values		
		Min.	Typ.	Max.
$BV_{DSS}$	$V_{GS} = 0V$ , $I_D = 250\mu\text{A}$	500		V
$V_{GS(th)}$	$V_{DS} = V_{GS}$ , $I_D = 50\mu\text{A}$	3.0		5.5 V
$I_{GSS}$	$V_{GS} = \pm 30V$ , $V_{DS} = 0V$			$\pm 100$ nA
$I_{DSS}$	$V_{DS} = V_{DSS}$ , $V_{GS} = 0V$ $T_J = 125^\circ\text{C}$			5 $\mu\text{A}$ 50 $\mu\text{A}$
$R_{DS(on)}$	$V_{GS} = 10V$ , $I_D = 0.5 \cdot I_{D25}$ , Note 1			2 $\Omega$

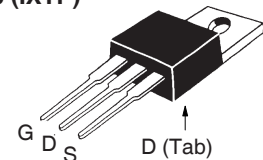
TO-252 (IXTY)



TO-263 (IXTA)



TO-220 (IXTP)



G = Gate      D = Drain  
S = Source    Tab = Drain

### Features

- International Standard Packages
- Low  $Q_G$
- Avalanche Rated
- Low Package Inductance
- Fast Intrinsic Rectifier

### Advantages

- High Power Density
- Easy to Mount
- Space Savings

### Applications

- DC-DC Converters
- Switch-Mode and Resonant-Mode Power Supplies
- AC and DC Motor Drives
- Discharge Circuits in Lasers, Spark Igniters, RF Generators
- High Voltage Pulse Power Applications



IXTY3N50P

IXTA3N50P

IXTP3N50P

Symbol	Test Conditions ( $T_J = 25^\circ\text{C}$ , Unless Otherwise Specified)	Characteristic Values		
		Min.	Typ.	Max
$g_{fs}$	$V_{DS} = 10\text{V}$ , $I_D = 0.5 \cdot I_{D25}$ , Note 1	2.5	3.5	S
$C_{iss}$	$V_{GS} = 0\text{V}$ , $V_{DS} = 25\text{V}$ , $f = 1\text{MHz}$		409	pF
$C_{oss}$			48	pF
$C_{rss}$			6.1	pF
$Q_{g(on)}$	$V_{GS} = 10\text{V}$ , $V_{DS} = 0.5 \cdot V_{DSS}$ , $I_D = 0.5 \cdot I_{D25}$		9.3	nC
$Q_{gs}$			3.3	nC
$Q_{gd}$			3.4	nC
$t_{d(on)}$	<b>Resistive Switching Times</b> $V_{GS} = 10\text{V}$ , $V_{DS} = 0.5 \cdot V_{DSS}$ , $I_D = 0.5 \cdot I_{D25}$ $R_G = 20\Omega$ (External)		15	ns
$t_r$			15	ns
$t_{d(off)}$			38	ns
$t_f$			12	ns
$R_{thJC}$	TO-220			1.8 °C/W
$R_{thCS}$		0.50		°C/W

#### Source-Drain Diode

Symbol	Test Conditions ( $T_J = 25^\circ\text{C}$ , Unless Otherwise Specified)	Characteristic Values		
		Min.	Typ.	Max
$I_S$	$V_{GS} = 0\text{V}$			3 A
$I_{SM}$	Repetitive, Pulse Width Limited by $T_{JM}$			9 A
$V_{SD}$	$I_F = I_S$ , $V_{GS} = 0\text{V}$ , Note 1			1.5 V
$t_{rr}$	$I_F = 3\text{A}$ , $-di/dt = 100\text{A}/\mu\text{s}$ , $V_R = 100\text{V}$		400	ns

Note 1. Pulse test,  $t \leq 300\mu\text{s}$ , duty cycle,  $d \leq 2\%$ .

IXYS Reserves the Right to Change Limits, Test Conditions, and Dimensions.

IXYS MOSFETs and IGBTs are covered by one or more of the following U.S. patents:	4,835,592	4,931,844	5,049,961	5,237,481	6,162,665	6,404,065B1	6,683,344	6,727,585	7,005,734B2	7,157,338B2
	4,860,072	5,017,508	5,063,307	5,381,025	6,259,123B1	6,534,343	6,710,405B2	6,759,692	7,063,975B2	
	4,881,106	5,034,796	5,187,117	5,486,715	6,306,728B1	6,583,505	6,710,463	6,771,478B2	7,071,537	

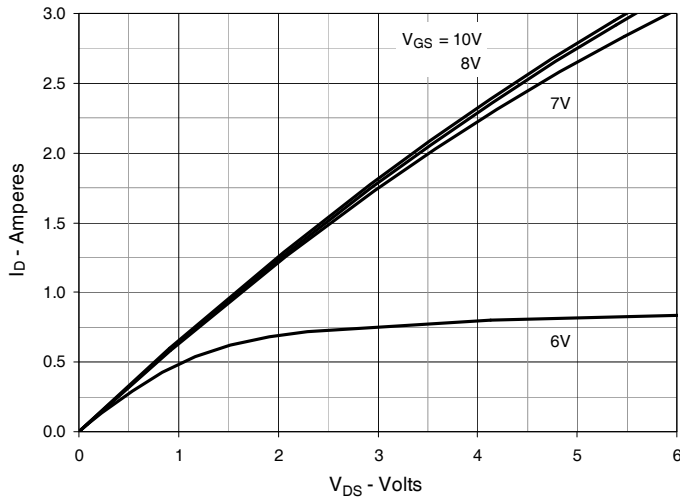
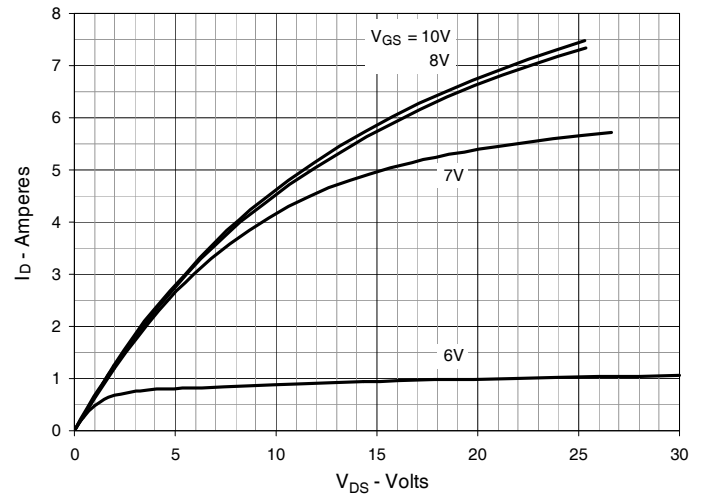
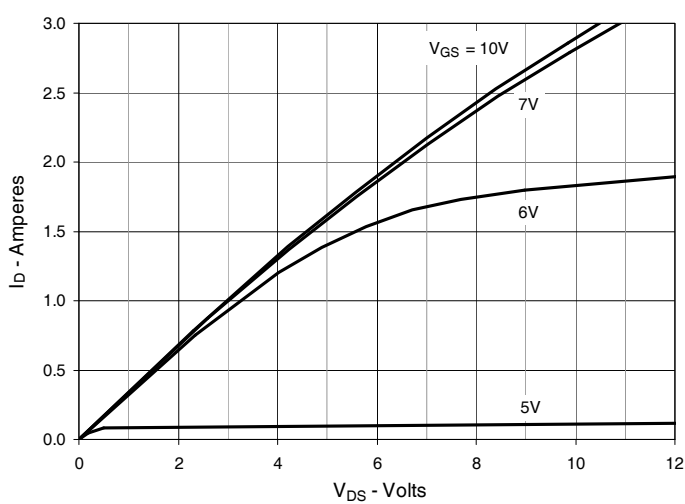
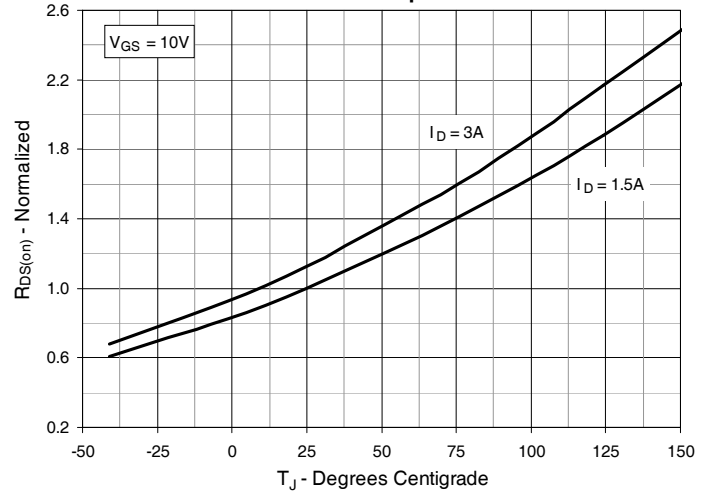
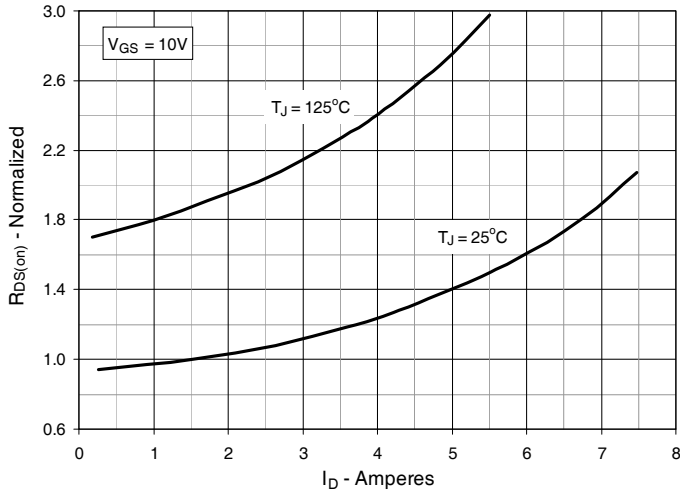
Fig. 1. Output Characteristics @  $T_J = 25^\circ\text{C}$ Fig. 2. Extended Output Characteristics @  $T_J = 25^\circ\text{C}$ Fig. 3. Output Characteristics @  $T_J = 125^\circ\text{C}$ Fig. 4.  $R_{DS(on)}$  Normalized to  $I_D = 1.5\text{A}$  Value vs. Junction TemperatureFig. 5.  $R_{DS(on)}$  Normalized to  $I_D = 1.5\text{A}$  Value vs. Drain Current

Fig. 6. Maximum Drain Current vs. Case Temperature

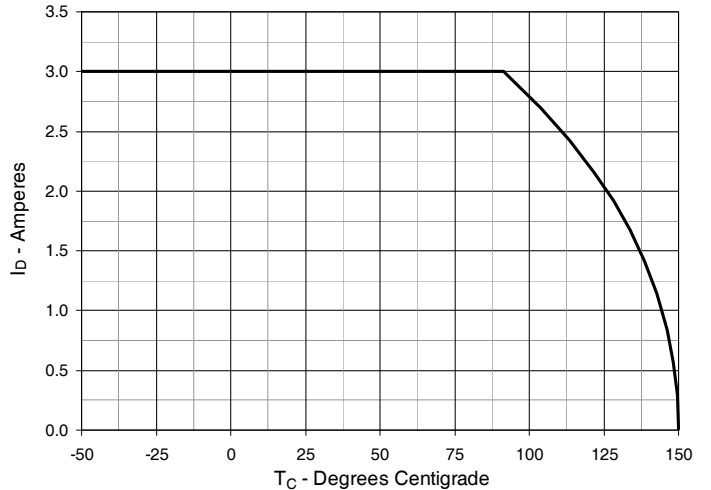


Fig. 7. Input Admittance

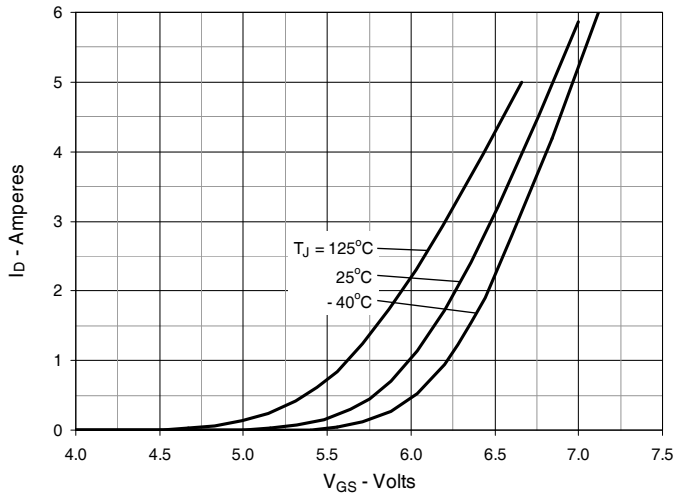


Fig. 8. Transconductance

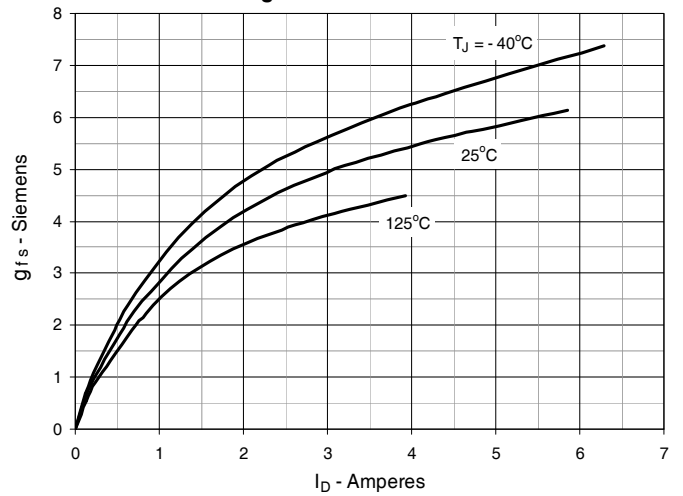


Fig. 9. Forward Voltage Drop of Intrinsic Diode

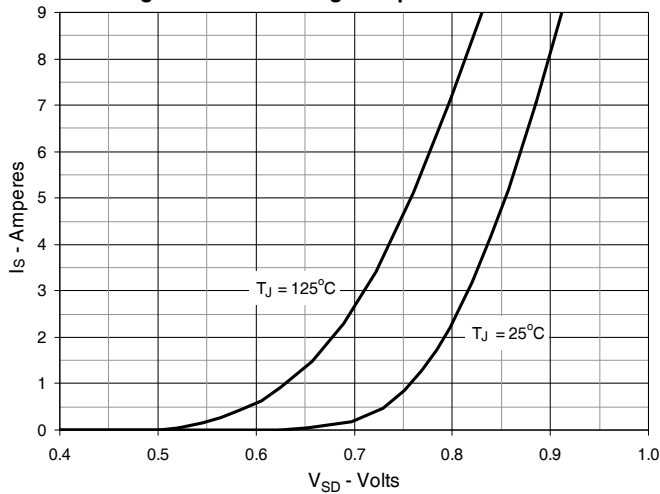


Fig. 10. Gate Charge

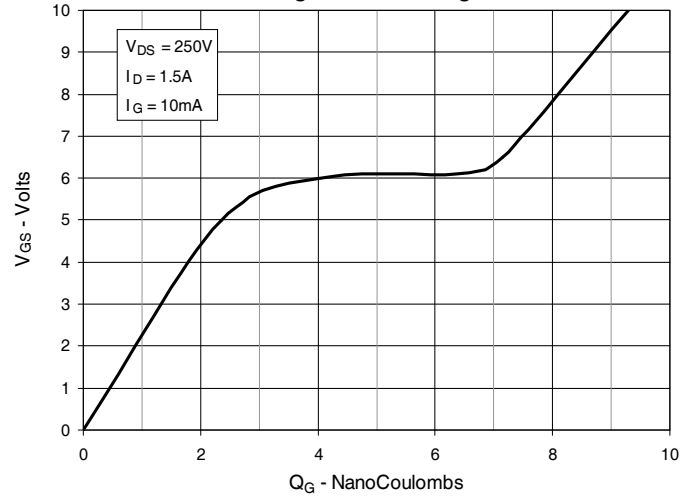


Fig. 11. Capacitance

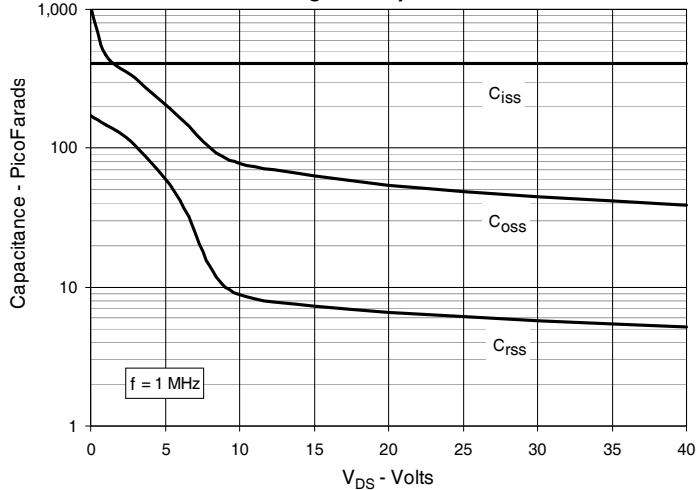


Fig. 12. Forward-Bias Safe Operating Area

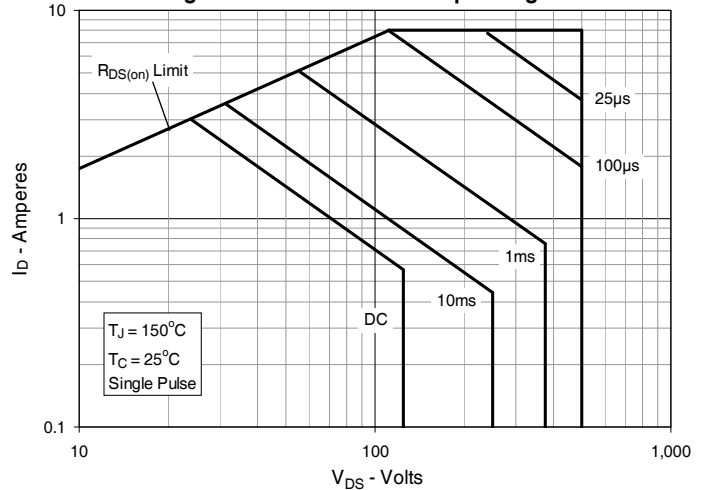
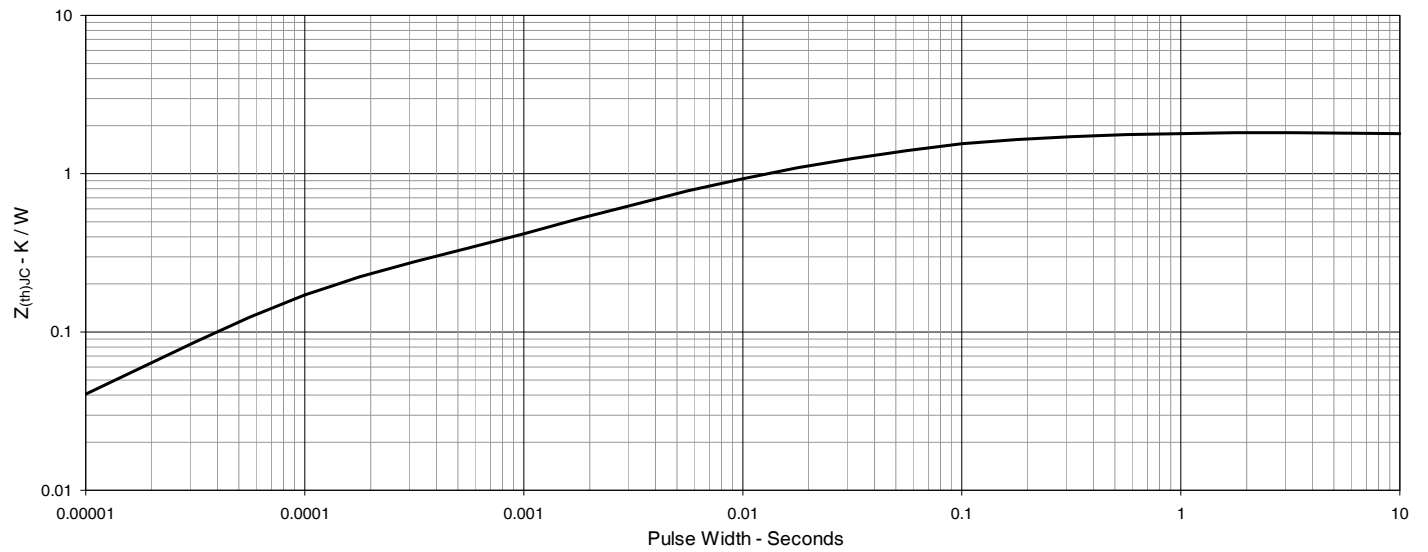


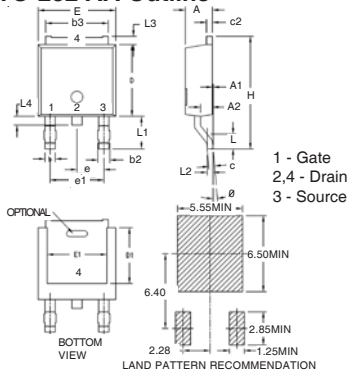
Fig. 13. Maximum Transient Thermal Impedance



IXYS

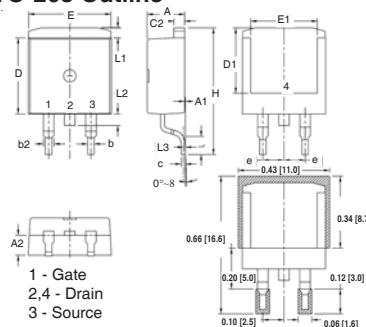
IXTY3N50P  
IXTA3N50P  
IXTP3N50P

## TO-252 AA Outline



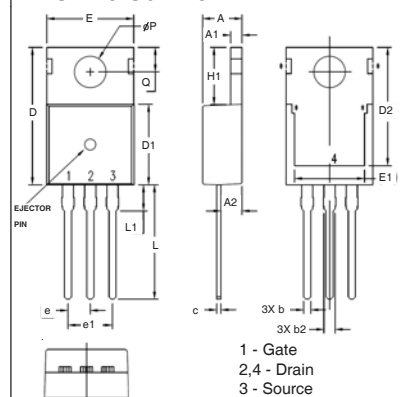
SYM	INCHES		MILLIMETERS	
	MIN	MAX	MIN	MAX
A	.086	.094	2.19	2.38
A1	0	.005	0	0.12
A2	.038	.046	0.97	1.17
b	.025	.035	0.64	0.89
b2	.030	.045	0.76	1.14
b3	.200	.215	5.08	5.46
c	.018	.024	0.46	0.61
c2	.018	.023	0.46	0.58
D	.235	.245	5.97	6.22
D1	.180	.205	4.57	5.21
E	.250	.265	6.35	6.73
E1	.170	.205	4.32	5.21
e	.090 BSC		2.28 BSC	
e1	.180 BSC		4.57 BSC	
H	.370	.410	9.40	10.42
L	.055	.070	1.40	1.78
L1	.100	.115	2.54	2.92
L2	.020 BSC		0.50 BSC	
L3	.025	.040	0.64	1.02
L4	.025	.040	0.64	1.02
θ	0°	10°	0°	10°

## TO-263 Outline



SYM	INCHES		MILLIMETER	
	MIN	MAX	MIN	MAX
A	.170	.185	4.30	4.70
A1	.000	.008	0.00	0.20
A2	.091	.098	2.30	2.50
b	.028	.035	0.70	0.90
b2	.046	.060	1.18	1.52
C	.018	.024	0.45	0.60
C2	.049	.060	1.25	1.52
D	.340	.370	8.63	9.40
D1	.300	.327	7.62	8.30
E	.380	.410	9.65	10.41
E1	.270	.330	6.86	8.38
e	.100 BSC		2.54 BSC	
H	.580	.620	14.73	15.75
L	.075	.105	1.91	2.67
L1	.039	.060	1.00	1.52
L2	—	.070	—	1.77
L3	.010 BSC		0.254 BSC	

## TO-220 Outline



SYM	INCHES		MILLIMETERS	
	MIN	MAX	MIN	MAX
A	.169	.185	4.30	4.70
A1	.047	.055	1.20	1.40
A2	.079	.106	2.00	2.70
b	.024	.039	0.60	1.00
b2	.045	.057	1.15	1.45
c	.014	.026	0.35	0.65
D	.587	.626	14.90	15.90
D1	.335	.370	8.50	9.40
(D2)	.500	.531	12.70	13.50
E	.382	.406	9.70	10.30
(E1)	.283	.323	7.20	8.20
e	.100 BSC		2.54 BSC	
e1	.200 BSC		5.08 BSC	
H1	.244	.268	6.20	6.80
L	.492	.547	12.50	13.90
L1	.110	.154	2.80	3.90
∅P	.134	.150	3.40	3.80
Q	.106	.126	2.70	3.20





---

Disclaimer Notice - Information furnished is believed to be accurate and reliable. However, users should independently evaluate the suitability of and test each product selected for their own applications. Littelfuse products are not designed for, and may not be used in, all applications. Read complete Disclaimer Notice at [www.littelfuse.com/disclaimer-electronics](http://www.littelfuse.com/disclaimer-electronics).

## OUR CERTIFICATE

DiGi provide top-quality products and perfect service for customer worldwide through standardization, technological innovation and continuous improvement. DiGi through third-party certification, we stricly control the quality of products and services. Welcome your RFQ to

Email: [Info@DiGi-Electronics.com](mailto:Info@DiGi-Electronics.com)



Tel: +00 852-30501935

RFQ Email: [Info@DiGi-Electronics.com](mailto:Info@DiGi-Electronics.com)

DiGi is a global authorized distributor of electronic components.