

# P2103ACL Datasheet



<https://www.DiGi-Electronics.com>

|                              |  |
|------------------------------|--|
| DiGi Electronics Part Number | P2103ACL-DG                                  |
| Manufacturer                 | <a href="#">Littelfuse Inc.</a>              |
| Manufacturer Product Number  | P2103ACL                                     |
| Description                  | THYRISTOR 170V 400A TO220-3                  |
| Detailed Description         | 170V Off-State 400 A Ipp TVS Thyristor 3-SIP |

This model P2103ACL is available at DiGi Electronics.

DiGi Electronics offers a global database of semiconductor and electronic component datasheets.

We welcome your inquiries regarding pricing, lead time, or other product-related questions.

 [Request a Quote](#)

 [Datasheet Search](#)



Tel: +00 852-30501935

RFQ Email: [Info@DiGi-Electronics.com](mailto:Info@DiGi-Electronics.com)

DiGi is a global authorized distributor of electronic components.

## Purchase and inquiry

Manufacturer Product Number:

P2103ACL

Series:

SIDACtor®

Voltage - Breakover:

250V

Voltage - On State:

8 V

Current - Peak Pulse (10/1000µs):

100 A

Number of Elements:

3

Mounting Type:

Through Hole

Supplier Device Package:

TO-220 Modified

Manufacturer:

Littelfuse Inc.

Product Status:

Active

Voltage - Off State:

170V

Current - Peak Pulse (8/20µs):

400 A

Current - Hold (Ih):

150 mA

Capacitance:

55pF, 85pF

Package / Case:

3-SIP

## Environmental & Export classification

RoHS Status:

ROHS3 Compliant

REACH Status:

REACH Unaffected

HTSUS:

8541.30.0080

Moisture Sensitivity Level (MSL):

1 (Unlimited)

ECCN:

EAR99

## SIDACTor® Primary Protection Balanced Series - Modified TO-220

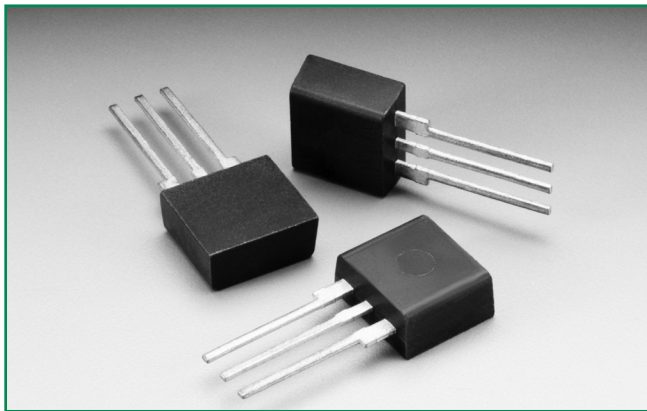

### Agency Approvals

| Agency | Agency File Number |
|--------|--------------------|
|        | E133083            |

### Pinout Designation

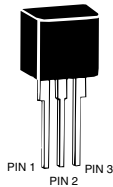

### Schematic Symbol

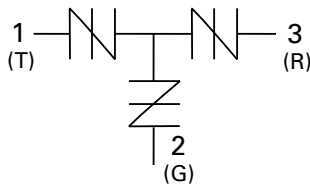

### Description

The SIDACTor® Primary Protection Balanced Series Modified TO-220 thyristors are components designed for use in primary protection applications.

The series provides a single port overvoltage solution that enables applications to comply with the balance requirements of GR-974 and GTS-8700. Please contact Littelfuse to discuss your particular application and regulatory requirements.

### Features and Benefits

- High holding current options available
- Balanced overvoltage protection
- Failsafe option available
- Low voltage overshoot
- Low on-state voltage
- Does not degrade surge capability after multiple surge events within limit.
- Fails short circuit when surged in excess of ratings
- Single-port protection
- Modified TO-220 Package
- Lead forms available
- RoHS Compliant
- Pb-free E3 means 2nd level interconnect is Pb-free and the terminal finish material is tin(Sn) IPC/JEDEC J-STD-609A.01

### Applicable Global Standards

- GR-974
- GTS-8700
- UL 497
- ITU K.28

### Electrical Characteristics

| Part Number | Marking | $V_{DRM}$<br>@ $I_{DRM}=5\mu A$ |       | $V_s$<br>@ 100V/ $\mu s$ | $I_H^*$ | $I_s$ | $I_T$ | $V_T @ I_T=2.2$<br>Amps                  | Capacitance |                     |        |  |
|-------------|---------|---------------------------------|-------|--------------------------|---------|-------|-------|--|-------------|---------------------|--------|--|
|             |         | V min                           | V max | mA min                   | mA max  | A max | V max | Pin 1-2 / 3-2<br>Tip-Ground, Ring-Ground |             | Pin 1-3<br>Tip-Ring |        |  |
|             |         | Pins 1-2, 3-2, 1-3              |       |                          |         |       |       | pF min                                   | pF max      | pF min              | pF max |  |
| P1553ACLxx  | P1553AC | 130                             | 180   | 150                      | 800     | 2.2   | 8     | 65                                       | 95          | 40                  | 60     |  |
| P1803ACLxx  | P1803AC | 150                             | 210   | 150                      | 800     | 2.2   | 8     | 55                                       | 85          | 35                  | 55     |  |
| P2103ACLxx  | P2103AC | 170                             | 250   | 150                      | 800     | 2.2   | 8     | 55                                       | 85          | 30                  | 55     |  |
| P2353ACLxx  | P2353AC | 200                             | 270   | 150                      | 800     | 2.2   | 8     | 50                                       | 75          | 30                  | 50     |  |
| P2703ACLxx  | P2703AC | 230                             | 300   | 150                      | 800     | 2.2   | 8     | 50                                       | 75          | 30                  | 50     |  |
| P3203ACLxx  | P3203AC | 270                             | 350   | 150                      | 800     | 2.2   | 8     | 45                                       | 70          | 25                  | 45     |  |
| P3403ACLxx  | P3403AC | 300                             | 400   | 150                      | 800     | 2.2   | 8     | 45                                       | 65          | 25                  | 45     |  |
| P5103ACLxx  | P5103AC | 420                             | 600   | 150                      | 800     | 2.2   | 8     | 40                                       | 60          | 20                  | 40     |  |

Notes:  
\* Higher holding current available by special order. Contact Littelfuse for additional information.  
- Absolute maximum ratings measured at  $T_A = 25^\circ C$  (unless otherwise noted).  
- Components are bi-directional.

- Off-state capacitance ( $C_o$ ) is measured at 1 MHz with a 2 V bias.  
- xx Part Number Suffix: **RP** (Reel pack), **Blank** (Bulk pack), **'60'** (Type 60 lead form bulk pack), **'FS1'** (Failsafe option bulk pack). Refer to Part Numbering section for additional details.

**Surge Ratings**

| Series | $I_{PP}$                                     |  |  |  |  |  |  |  |   | $I_{TSM}$<br>50/60 Hz | di/dt |
|--------|--|--|--|--|--|--|--|--|---|-----------------------|-------|
|        | 0.2/310 <sup>1</sup><br>0.5/700 <sup>2</sup> | 2/10 <sup>1</sup><br>2/10 <sup>2</sup> | 8/20 <sup>1</sup><br>1.2/50 <sup>2</sup> | 10/160 <sup>1</sup><br>10/160 <sup>2</sup> | 10/560 <sup>1</sup><br>10/560 <sup>2</sup> | 5/320 <sup>1</sup><br>9/720 <sup>2</sup> | 10/360 <sup>1</sup><br>10/360 <sup>2</sup> | 10/1000 <sup>1</sup><br>10/1000 <sup>2</sup> | 5/310 <sup>1</sup><br>10/700 <sup>2</sup> |                       |       |
|        | A min  | A min                                  | A min                                    | A min                                      | A min                                      | A min                                    | A min                                      | A min  | A min                                     |                       |       |
| C      | 50   | 500                                    | 400                                      | 200  | 150  | 200                                      | 175  | 100  | 200                                       | 50                    | 500   |

Notes:

- 1 Current waveform in  $\mu s$
- 2 Voltage waveform in  $\mu s$

- Peak pulse current rating ( $I_{pp}$ ) is repetitive and guaranteed for the life of the product in thermal equilibrium.
- $I_{pp}$  ratings applicable over temperature range of -40°C to +85°C
- The component must initially be in thermal equilibrium with -40°C  $\leq T_J \leq$  +150°C

**Thermal Considerations**

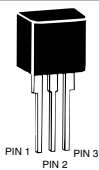
| Package  | Symbol          | Parameter                               | Value       | Unit |
|--|-----------------|---|-------------|------|
| Modified TO-220<br> | $T_J$           | Operating Junction Temperature Range    | -40 to +150 | °C   |
|  | $T_S$           | Storage Temperature Range               | -65 to +150 | °C   |
|  | $R_{\theta JA}$ | Thermal Resistance: Junction to Ambient | 50          | °C/W |

**V-I Characteristics**

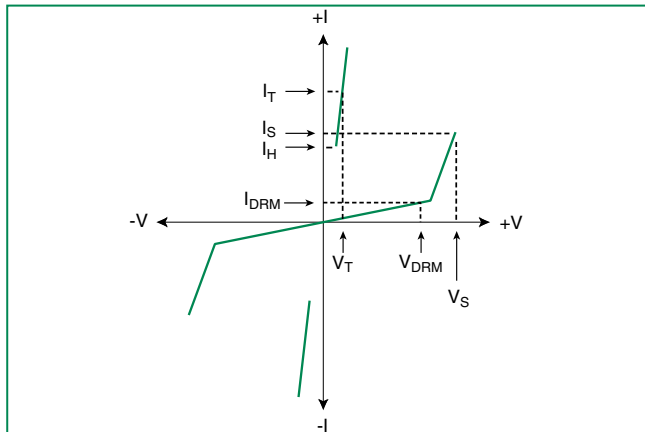

**$t_r \times t_d$  Pulse Waveform**

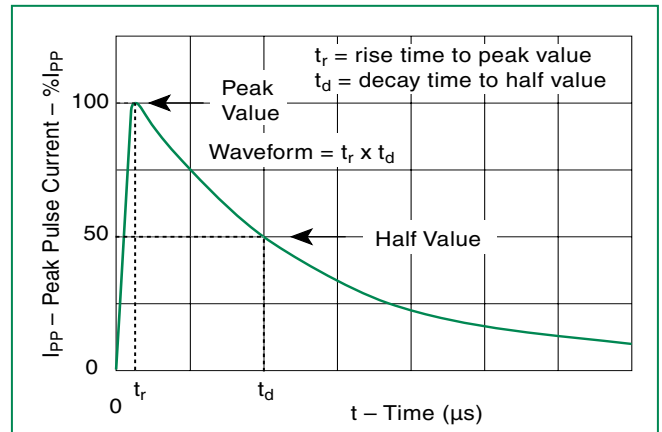

**Normalized  $V_S$  Change vs. Junction Temperature**

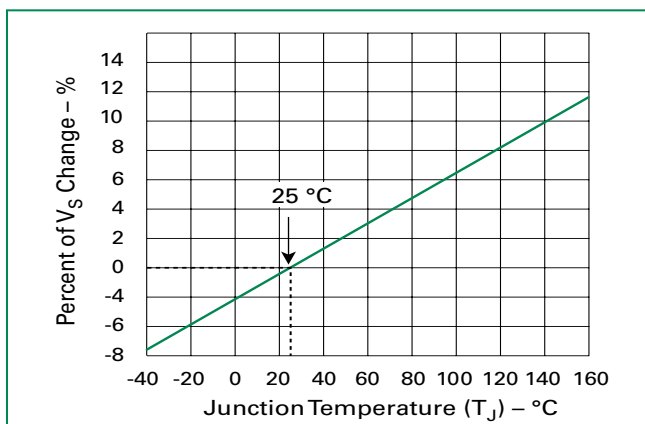

**Normalized DC Holding Current vs. Case Temperature**

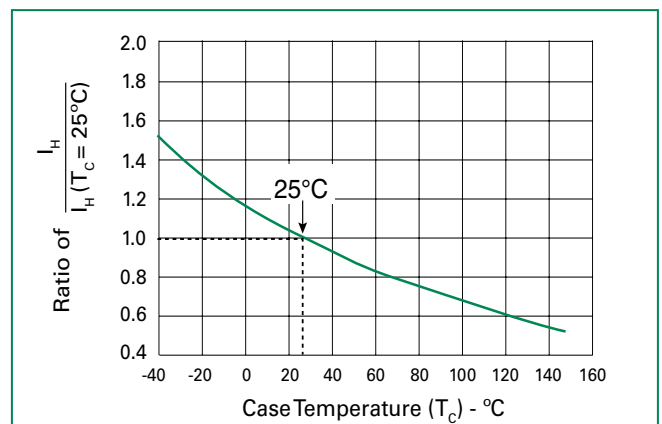

### Soldering Parameters

|  |                                    |                               |
|--|------------------------------------|-------------------------------|
| Reflow Condition                                       |                                    | Pb-Free assembly (see Fig. 1) |
| Pre Heat   | - Temperature Min ( $T_{s(min)}$ ) | +150°C                        |
|  | - Temperature Max ( $T_{s(max)}$ ) | +200°C                        |
|  | - Time (Min to Max) ( $t_s$ )      | 60-180 secs.                  |
| Average ramp up rate (Liquidus Temp ( $T_L$ ) to peak) |                                    | 3°C/sec. Max.                 |
| $T_{s(max)}$ to $T_L$ - Ramp-up Rate                   |                                    | 3°C/sec. Max.                 |
| Reflow   | - Temperature ( $T_L$ ) (Liquidus) | +217°C                        |
|  | - Temperature ( $t_L$ )            | 60-150 secs.                  |
| Peak Temp ( $T_p$ )                                    |                                    | +260(+0/-5)°C                 |
| Time within 5°C of actual Peak Temp ( $t_p$ )          |                                    | 30 secs. Max.                 |
| Ramp-down Rate   |                                    | 6°C/sec. Max.                 |
| Time 25°C to Peak Temp ( $T_p$ )                       |                                    | 8 min. Max.                   |
| Do not exceed  |                                    | +260°C                        |

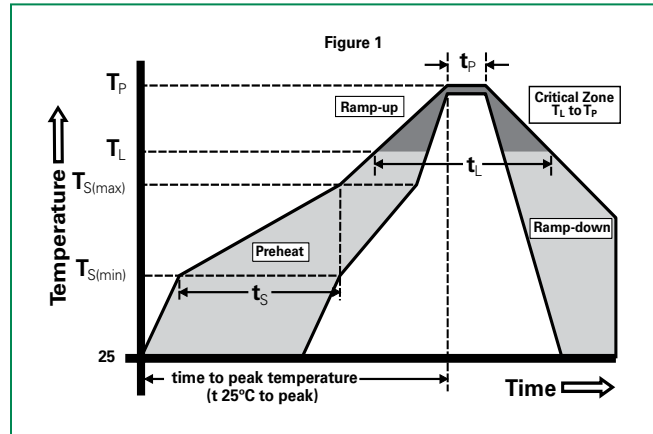

### Physical Specifications

|                        |   |
|------------------------|---|
| <b>Lead Material</b>   | Copper Alloy  |
| <b>Terminal Finish</b> | 100% Matte-Tin Plated                                       |
| <b>Body Material</b>   | UL Recognized epoxy meeting flammability classification V-0 |

### Environmental Specifications

|   |   |
|---|---|
| <b>High Temp Voltage Blocking</b>       | 80% Rated $V_{DRM}$ ( $V_{AC}$ Peak) +125°C or +150°C, 504 or 1008 hrs. MIL-STD-750 (Method 1040) JEDEC, JESD22-A-101 |
| <b>Temp Cycling</b>                     | -65°C to +150°C, 15 min. dwell, 10 up to 100 cycles. MIL-STD-750 (Method 1051) EIA/JEDEC, JESD22-A-104                |
| <b>Biased Temp &amp; Humidity</b>       | 52 $V_{DC}$ (+85°C) 85%RH, 504 up to 1008 hrs. EIA/JEDEC, JESD22-A-101  |
| <b>High Temp Storage</b>                | +150°C 1008 hrs. MIL-STD-750 (Method 1031) JEDEC, JESD22-A-101  |
| <b>Low Temp Storage</b>                 | -65°C, 1008 hrs.  |
| <b>Thermal Shock</b>                    | 0°C to +100°C, 5 min. dwell, 10 sec. transfer, 10 cycles. MIL-STD-750 (Method 1056) JEDEC, JESD22-A-106               |
| <b>Autoclave (Pressure Cooker Test)</b> | +121°C, 100%RH, 2atm, 24 up to 168 hrs. EIA/JEDEC, JESD22-A-102   |
| <b>Resistance to Solder Heat</b>        | +260°C, 30 secs. MIL-STD-750 (Method 2031)  |
| <b>Moisture Sensitivity Level</b>       | 85%RH, +85°C, 168 hrs., 3 reflow cycles (+260°C Peak). JEDEC-J-STD-020, Level 1                                       |

### Part Numbering

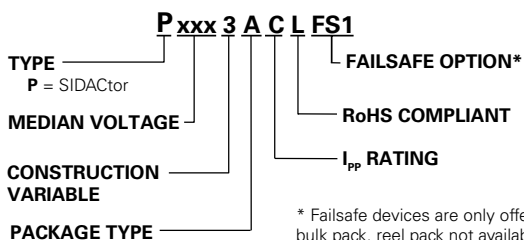
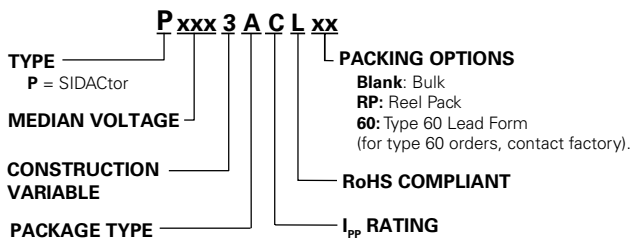

### Part Marking

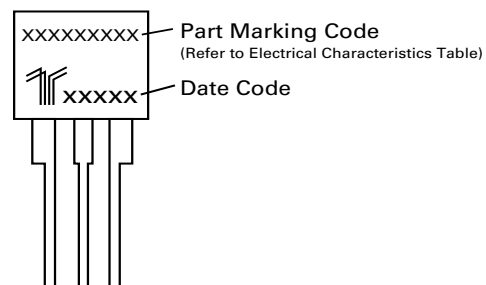

### Dimensions - Modified TO-220

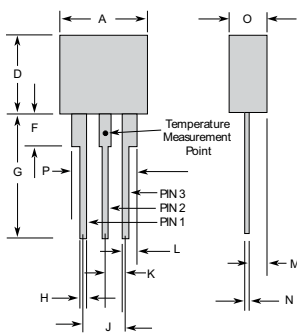

The modified TO-220 package is designed to meet mechanical standards as set forth in JEDEC publication number 95.

|          | Inches |       | Millimeters |       |
|----------|--------|-------|-------------|-------|
|          | Min    | Max   | Min         | Max   |
| <b>A</b> | 0.400  | 0.410 | 10.16       | 10.42 |
| <b>D</b> | 0.360  | 0.375 | 9.14        | 9.53  |
| <b>F</b> | 0.110  | 0.130 | 2.80        | 3.30  |
| <b>G</b> | 0.540  | 0.575 | 13.71       | 14.61 |
| <b>H</b> | 0.025  | 0.035 | 0.63        | 0.89  |
| <b>J</b> | 0.195  | 0.205 | 4.95        | 5.21  |
| <b>K</b> | 0.095  | 0.105 | 2.41        | 2.67  |
| <b>L</b> | 0.060  | 0.075 | 1.52        | 1.90  |
| <b>M</b> | 0.070  | 0.085 | 1.78        | 2.16  |
| <b>N</b> | 0.018  | 0.024 | 0.46        | 0.61  |
| <b>O</b> | 0.178  | 0.188 | 4.52        | 4.78  |
| <b>P</b> | 0.290  | 0.310 | 7.37        | 7.87  |

### Dimensions - Modified TO-220 with Failsafe

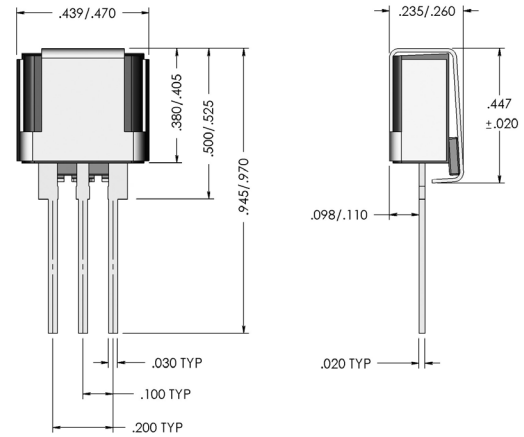

### Tape and Reel Specification - Modified TO-220

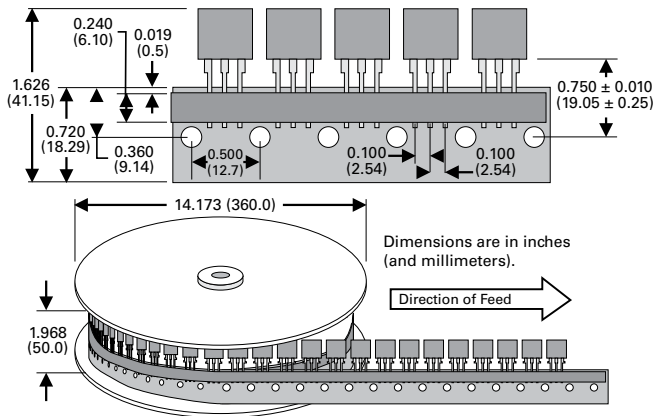

### Dimensions - Modified TO-220 Type 60 with Failsafe

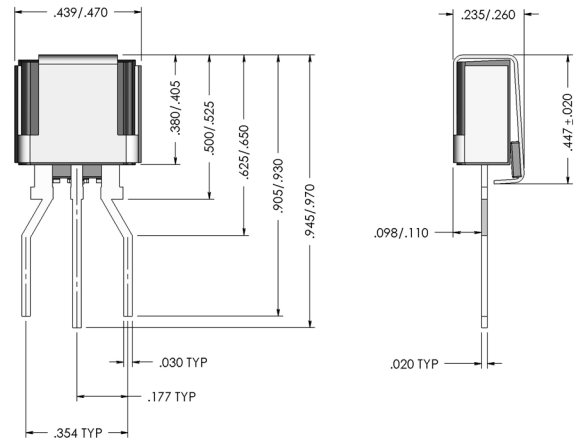

### Packing Options

| Package Type | Description                                 | Quantity | Added Suffix  | Industry Standard |
|--------------|---|----------|---|-------------------|
| A            | Modified TO-220 Tape and Reel Pack          | 700      | RP  | EIA-468-B         |
|              | Modified TO-220 Bulk Pack                   | 500      | (no added suffix)                                       | N/A               |
|              | Modified TO-220 Type 60 Lead Form Bulk Pack | 500      | 60<br>(special order item, contact factory for details) | N/A               |

**Disclaimer Notice - Information furnished is believed to be accurate and reliable. However, users should independently evaluate the suitability of and test each product selected for their own applications. Littelfuse products are not designed for, and may not be used in, all applications. Read complete Disclaimer Notice at [www.littelfuse.com/disclaimer-electronics](http://www.littelfuse.com/disclaimer-electronics).**

## OUR CERTIFICATE

DiGi provide top-quality products and perfect service for customer worldwide through standardization, technological innovation and continuous improvement. DiGi through third-party certification, we stricly control the quality of products and services. Welcome your RFQ to

Email: [Info@DiGi-Electronics.com](mailto:Info@DiGi-Electronics.com)



Tel: +00 852-30501935

RFQ Email: [Info@DiGi-Electronics.com](mailto:Info@DiGi-Electronics.com)

DiGi is a global authorized distributor of electronic components.